



# **USER'S GUIDE**

**PORTABLE DATA COLLECTION  
TERMINAL**

---

**PT600**

DOCUMENT NUMBER: 350600-0010

# NOTICE

**The unit is equipped with a NiMH battery pack, however it may not be powered on due to discharging of the battery by putting in storage for a period of time.**

**In the case of above situation happened, plug in an 9V AC-DC adapter and recharge the NiMH battery pack about 14~16 hours or put into cradle about 2.5 hours with 12V AC-DC adapter before using the unit. (please refer to chapter 2.4 for charging reference)**

# Table of Content

	<u>Page</u>
<b>Chapter 1 Introduction .....</b>	<b>1</b>
1.1 Technical Specification .....	2
1.2 Interface Ports .....	8
1.3 Using the Keyboard .....	9
1.4 Triggering Scanner Module.....	11
1.5 Application Development Environment .....	12
1.6 Optional Charging/Communication Cradle...	13
<b>Chapter 2 Power System.....</b>	<b>14</b>
2.1 Power Supply.....	14
2.2 Power Low Indication.....	14
2.3 Battery Replacement .....	15
2.4 Recharging the Battery Pack .....	17
2.5 Storage and Safety Precautions .....	18
<b>Chapter 3 Operation .....</b>	<b>19</b>
3.1 Ready Mode.....	19
3.2 User Mode and System Commands .....	20
3.3 Configure the Terminal in SET command ....	22
3.4 Upload/Download by ESC command.....	24
<b>Chapter 4 Built-in Application:FormCaching .....</b>	<b>25</b>
4.1 Specification of FormCaching .....	25
4.2 How to Create a FormCaching.....	26
4.3 How to Run FormCaching.....	26
4.4 Default Settings of FormCaching.....	27

# Chapter 1 Introduction

The PT600 Portable Data Terminal, referred as PDT hereafter, with integrated **laser scanner** or **pen scanner** is a rugged, compact and lightweight hand-held data collection terminal with good reliability, flexibility and maintainability. Its compact size and form makes it even fits in your packet. The PDT incorporates a DOS-based system and provides users a PC compatible environment to develop and use the device. This terminal is well suited for transportation, warehouse distribution, retail management, asset tracking and many other data collection applications.

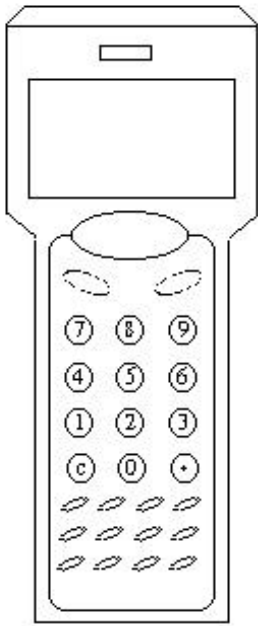

Top View



Right side View

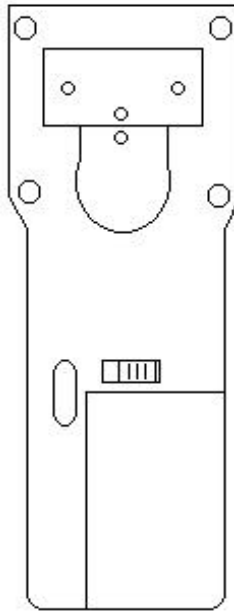

Back View

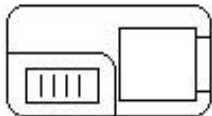

Bottom View

## 1.1 Technical Specification

### SOFTWARE PROGRAMMING TOOLS

<b>Language</b>	Assembly, C language (MSC, Turbo C, Visual C)
<b>JobGen Plus</b>	A Windows-based transaction program generator
<b>JobGen Pro</b>	A Dos-based transaction program generator
<b>FormCaching</b>	A built-in program generator

### CPU/MEMORY

<b>CPU</b>	16-bit 8088 compatible microprocessor CPU
<b>Memory</b>	512KB to up of 4.5MB SRAM
<b>Flash ROM</b>	256K with DOS-based system
<b>Keyboard</b>	26 alphanumeric rubber keys with one laser trigger switch
<b>Buzzer</b>	Volume adjustable by software
<b>Real time clock</b>	System date and time
<b>Display</b>	100x65 pixel graphic backlit LCD with selection between 12-column by 4-line in 8x16 font and 16-column by 8-line in 6x8 font by menu setup or system call

### BARCODE SYMBOLOGY

<b>Barcode reading</b>	UPC-A/E, EAN-8/13, Codabar, Code128, Code39, Code39 with full ASCII, ITF, China postal code, Interleave 2 of 5, EAN128
------------------------	--

### PHYSICAL AND ENVIRONMENT

<b>Dimensions</b>	176mm(L) x 52mm/62mm(W) x 27mm/35mm(H)
<b>Weight</b>	Approximately 240g with battery pack
<b>Temperature</b>	Operation: 0°C ~ 50°C (32°F ~ 122°F) Storage: -20°C ~ 70°C (-4°F ~ 158°F)
<b>Humidity</b>	4 ~ 95% RH non-condensing

## **COMMUNICATION**

<b>Interface</b>	One EIA RS232C with miniature DIN-9p male connector, Support TX/RX, CTS/RTS, GND, up to 57.6Kbps (default value is 19.2 Kbps)
<b>Handshaking</b>	One IR port, Support TX/RX, from 19.2 to 57.6 Kbps Xon/Xoff or CTS/RTS
<b>Protocol</b>	None or Multi-protocol
<b>File Transfer</b>	Build-in Kermit server or Multi-protocol

## **POWER SUPPLY**

<b>Operation</b>	2AA size NiMH @ 1.2V, 1500mah Both of them are store in detachable battery pack
<b>Backup</b>	One lithium CR2032 backup battery
<b>Power manager</b>	Low power consumption and warning on power low for operating/backup battery
<b>Power input</b>	AC/DC adapter @ 9VDC/500mA

## **DOCKING STATION**

<b>Interface</b>	One serial infrared interface for data communication via PT600 One RS485 port for RS485 multiple stations networking One RS232 port for point-to-point communication to host computer
<b>Power charging</b>	Soft-contact charging pads to main unit and spare battery Quick charging for typical 2.5 hours
<b>Power input</b>	AC/DC adapter @ 12VDC/1A

## **Operation System**

- MS-DOS compatible system
- Reads all major bar code symbologies auto-discriminated
- Menu-driven user configuration interface
- Software adjustable beeper volume and LCD contrast
- System resumes from the last turn-off point.

- Built-in power-on self test and diagnostic program
- Host command remote control

### Integrated Laser Diode Scanner

- Scan rate 36 scans/sec
- Skew Tolerance  $\pm 65^\circ$  from normal
- Pitch Angle  $\pm 55^\circ$  of normal
- Power consumption 60mA typ.@5V

### Integrated clip-on Pen Scanner

- Resolution 0.12mm(5mil)
- Dept of field 0.1mm(0.04inch)
- Scan rate 5-200 cm/sec
- Reading Angle  $45^\circ \sim 135^\circ$
- Print Contrast Ratio 0.5 min

### *Diagram shown with a Built-in Integrated Laser scanner*

#### Skew Tolerance

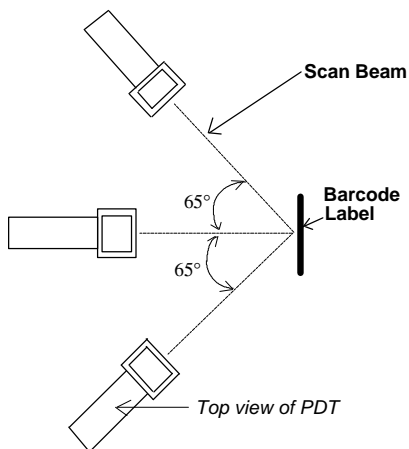

#### Pitch Angle

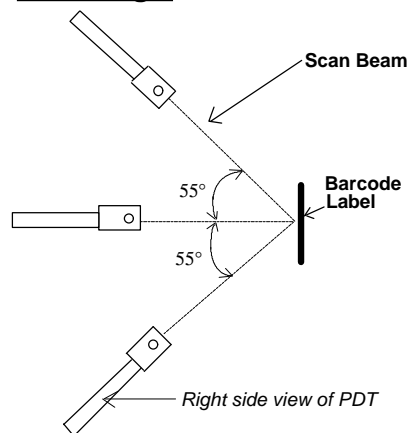

# Depth of Field diagram

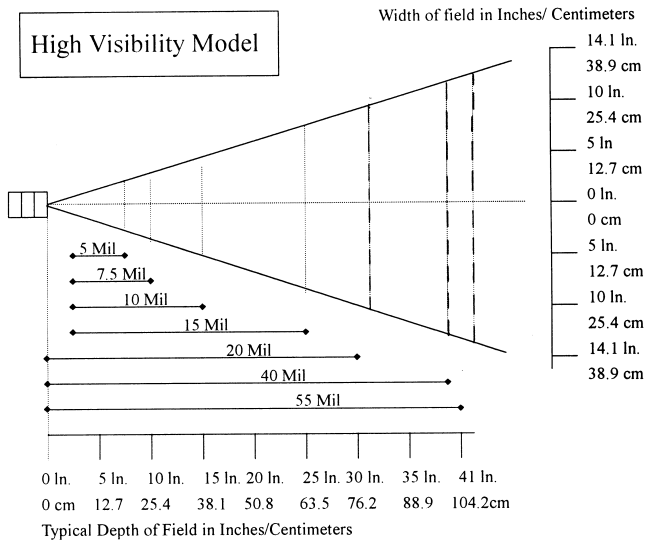
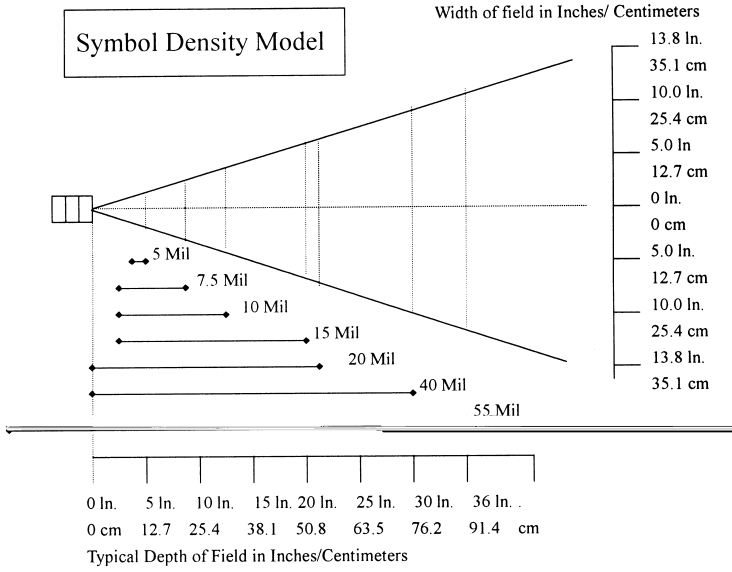



### High Density Model

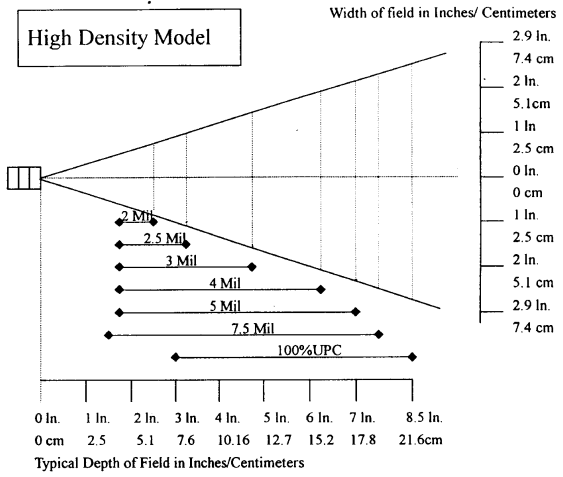

### Wide Angle Model

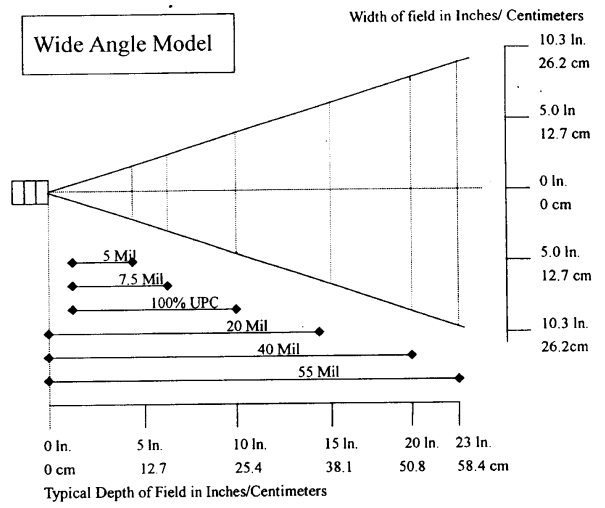

**Diagram shown with a clip-on pen scanner**

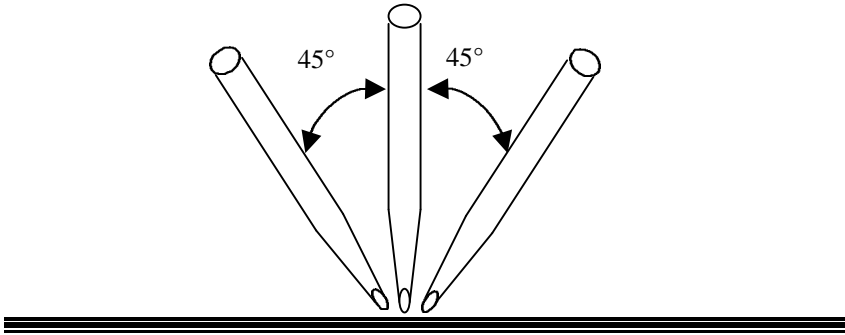

## 1.2 Interface Ports

The PT600 has a RS232C serial port with miniature RJ10 connector, Communication by Infrared LED which on the left side of lower cabinet and charging pads locate on the bottom.

Pin	Signal	Direction	Description
1	DC9 V	Input	External power input
2	TXD	Output	Transmit data
3	RXD	Input	Receive data
4	N.C.		
5	GND	Reference	Ground
6	N.C.		
7	CTS	Input	Clear to send
8	RTS	Output	Request to send
9	N.C.		
10	N.C.		

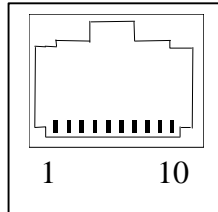

The diagram below shows the way to connect input/output devices to the PDT.

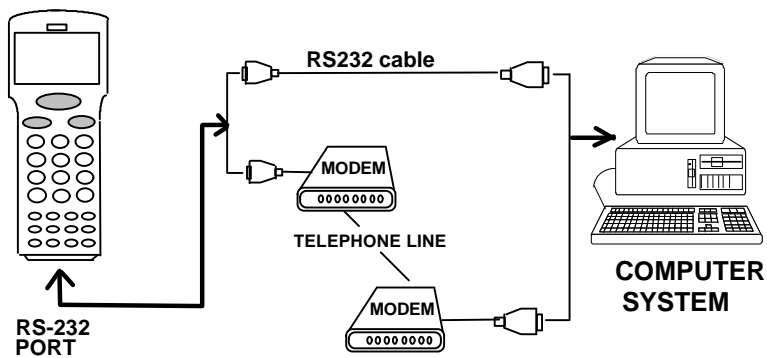

## 1.3 Using the Keyboard

The keypad of PT600 consists of 27 rubber keys, the **key** is used to switch on/off the unit and other 26 keys are used to control the unit and key in data. The use of keyboard is categorized to three modes: **normal mode**, **command mode**, and **alpha(betic) mode**. All keys except **key** may produce a sound (tone) when pressed. Keys of upper four rows have larger size for easier key-pressing to input numbers.

[ ] When the unit is off, pressing the **key** will turn on the unit. On the other hand, when the unit is on it is needed to press and hold down the **key** for about one second in order to turn the unit off.

[CMD] Pressing the [CMD] key sets the keyboard to Command mode. However pressing and holding down the [CMD] key for two seconds in Ready mode will enter the **User mode**. In User mode, users can invoke system commands by menu selection.

[ESC] In **User mode** or **Supervisor mode**, pressing the [CMD] key and then pressing [ALPHA] key will exit from the current operation to the previous operation.

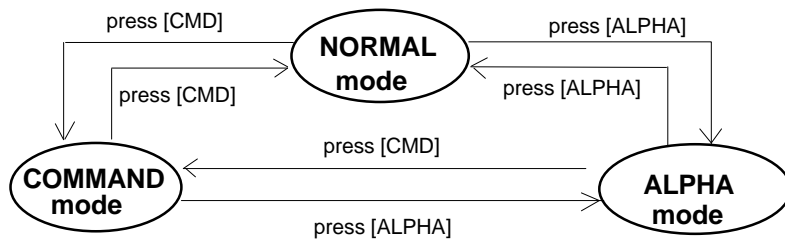

## NORMAL mode

Keyboard of the PT600 is initialized to normal mode after powered on. In normal mode, the cursor is a block sign and the keyboard is mainly used to input numeric data and use F1-F4 four function-keys. The keypad layout of available keys in normal mode is shown on right picture.

- key for next data search**
- key for last data search**

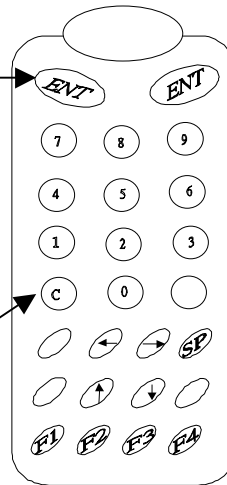

## COMMAND mode

Press [CMD] key sets the keyboard to command mode. In command mode, the cursor type keeps same and the keyboard is mainly used to input special characters, make hot-key function, and use F5-F8 four function-keys. The keypad layout of available keys on command mode is shown on right picture. There are three hot-key functions and the usage of each function is described below.

## ALPHA mode

Press [ALPHA] key to toggle between normal mode and alpha mode of keyboard. In alpha mode, the cursor is an underscore sign and the keyboard is available to input upper case letters. In alpha mode, every numeric key contains 3 characters individually. Pressing the key [→] and [←] to choose among three available characters.

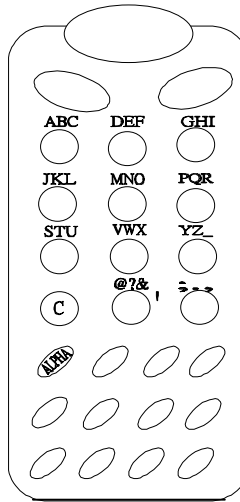

For example :

First press [ALPHA] to switch the system to alpha mode, the cursor type will be changed from block to underscore

To enter 'A', hit [←] then [7].

To enter 'B', hit [7].

To enter 'C', hit [→] then [7].

## 1.4 Triggering Scanner Module

The PT600 can be used with a built-in integrated laser scanner module or clip-on pen scanner module. The built-in decoder reads barcode labels of all major bar code labels.

The user should keep laser window or tip of pen clean to prevent low reading rate of distorted bar code input signal.

## 1.5 Application Development Environment

The system of PT600 provides DOS functions and device drivers for application development, including bar code decoding, keypad input, display output, serial input/output communication, real-time-clock access and power management control.

The PT600 can be programmed by the high-level Windows-based JobGen Plus and DOS-based JobGen Pro program generation software. It can also be programmed by commonly used C compilers including Microsoft C, Borland C and Turbo C. An executable program generated by JobGen Pro, JobGen Plus or created by a compiler is downloaded to the unit and run on the unit.

### **JobGen Plus**

JobGen Plus is a Windows-based program generator that gives the user an ease-of-use and comprehensive terminal application developing environment. Through the use of JobGen Plus, user can design an application program for a data collection terminal by simply drawing the data collection sequence on paper, and thus, requires minimum programming skills.

### **JobGen Pro**

The Job Generator Pro is a DOS-based program generator software of the PDT. With the Job Generator Pro, users can easily create the applications by defining the data fields of a transaction and then download an executable program generated by JobGen Pro to the PT600. After data collected and processed on the PT600, the data can be uploaded to the PC for further processing.

For more detailed information, please refer to *PT600 Programming Reference Manual*, *JobGen Plus User's Manual* and *JobGen Pro User's Manual* respectively.

## 1.6 Optional Charging/Communication Cradle

An optional charging/communication cradle (docking station), PT016, gives users a convenient accessory for daily use of the PT600. The cradle has been incorporated a quick charge circuit that the NiMH battery pack installed in the unit along with an extra spare pack can be fully charged in about **2.5** hours. Regular charging time of the battery pack through DC power adapter is about **14~16** hours. The cradle also allows users to link the PT600 to host computer through point-to-point RS-232 or multi-point RS-422 connection for data communication. The cradle with internal modem will be available in the future.

### **POINT-TO-POINT RS232 Connection**

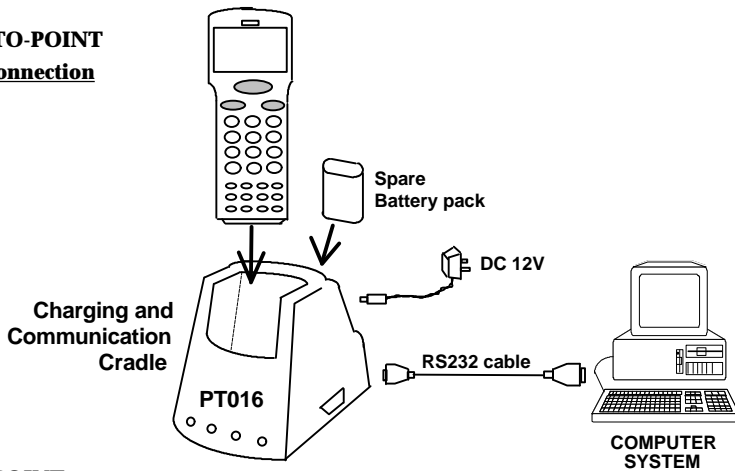

### **MULTI-POINT RS422 Connection**

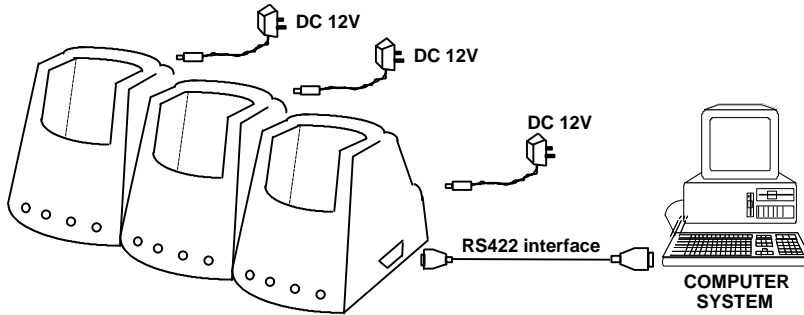



# Chapter 2 Power System

## 2.1 Power Supply

### Main Power

The PDT is operated by a rechargeable NiMH battery pack with two AA size 1.2V 1500mAH capacity or two AA alkaline batteries for the main power source.

### Back up Power

An onboard 3V 190mAH Lithium battery (CR2032) is used as the secondary power source to back up the data in RTC (real time clock chip) and RAM memory to provide users a data-loss free environment.

Normally the PT600 gets power from main power source to back-up RTC and RAM and puts the Lithium battery in standby state. When the main power source is removed or below the level to back-up the RAM and RTC properly, the power circuit of the PT600 automatically switches to the Lithium battery for back up. It is recommended that the main battery be always placed inside the unit with enough capacity for back-up purpose in which case the Lithium battery can supply the power for up to **5 years** before consuming all its capacity up.

## 2.2 Power Low Indication

### Main Battery

When the main power source reaches the battery low condition, a warning message as right will be shown on the LCD when PT600 is powered on or a battery **low icon sign** will emerge on the right sidebar of LCD.

! WARNING !  
MAIN BATTERY  
VOLTAGE LOW

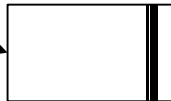

When the main battery low condition occurs, the main battery can continue to supply power for about 10 ~ 30 minutes, however the unit may reach the system power cutoff point and automatically turn itself off. Meanwhile the unit continues to back-up the data contents in RTC and RAM, but it cannot be powered up until the batteries have been recharged or replaced.

### **Lithium Backup Battery**

When the Lithium backup battery doesn't have enough capacity to back up the system, the message as right will be shown on LCD when the unit is powered on. In this situation you should upload your data from the PDT immediately and replace a new Lithium battery.

! WARNING ! LITHIUM BATTERY LOW
---------------------------------------

## **2.3 Battery Replacement**

### **Main Battery**

1. Make sure the unit is turned off.
2. Turn over the unit. Slide tab from right to left (see illustrations in next page).
3. Slide the main battery pack from battery compartment.
4. Insert the new main battery packet:

## Remove battery pack      Remove backup battery

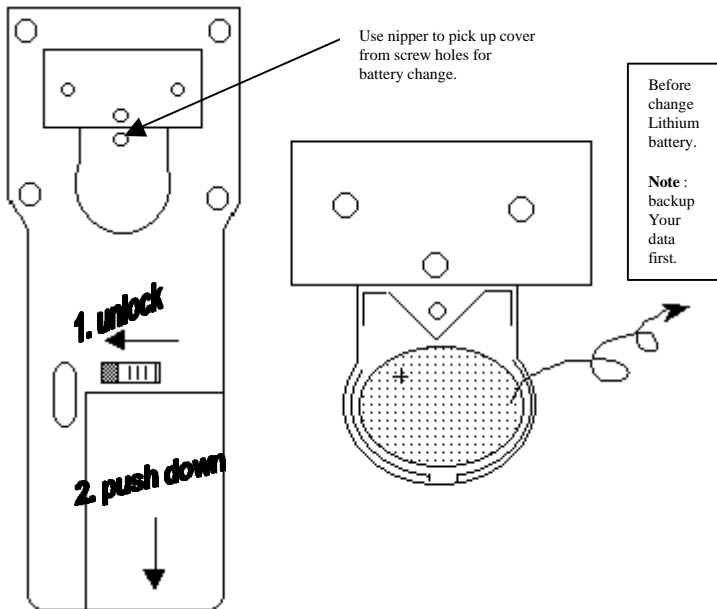

## Lithium Back up Battery

1. Refer to the procedure in previous paragraph, un-screw the backup battery cover and as illustration above to remove the lithium battery.
2. Insert a new battery into the holder with correct orientation.
3. Put the battery cover back.

\* ***Make sure to back up your data in PDT before making the replacement the lithium back up battery.***

## 2.4 Recharging the Battery Pack

When the PDT shows “Main battery low” message or sign , the battery pack in PDT needs to be recharged. There are two ways to charge the battery: regular and quick charging as shown below.

### Regular Charging

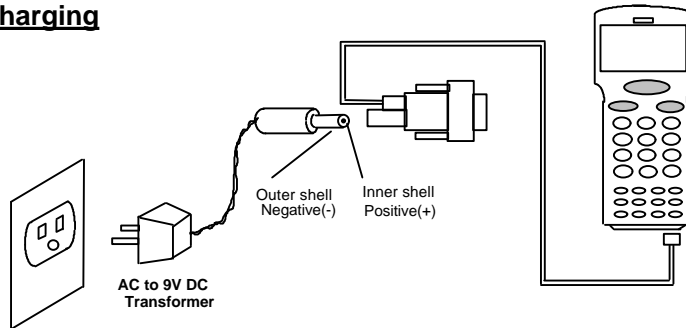

Plug one end of an AC-9VDC power adapter into the DC-jack of RS232 cable and the other end into a wall outlet. The battery pack will be fully recharged after 14~16 hours.

### Quick Charging with PT016

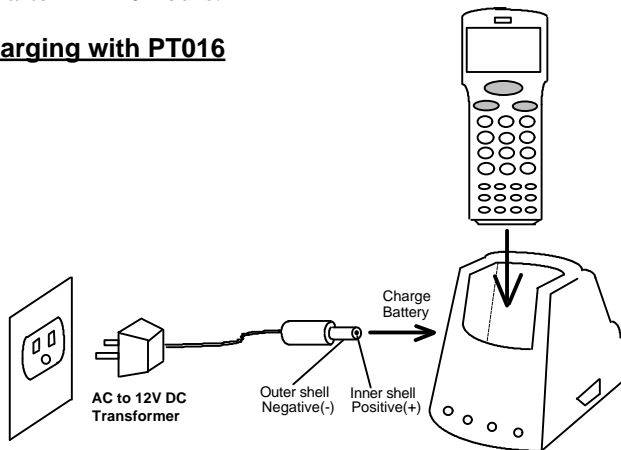

Connect power adapter to PT016 and insert PDT into the chamber of PT016. The battery of PDT can be fully charged in about 2.5 hours and the status of battery charging is indicated by the LED on the front panel of PT016.(please refer to PT016 manual for detail information. )

## **Charging Considerations**

It is important to consider the surrounding temperature whenever you are charging the NiMH battery pack. The process is most efficient at normal room temperature or slightly cooler. It is essential that you charge batteries within the stated range of 32°F to 113°F (0°C to 45°C). Charging batteries outside of the specified range could damage the batteries and shorten their life cycle.

## **Effects Of Overcharging Batteries**

Overcharging may occur when a NiMH rechargeable battery is charged in regular or quick charging rate after it has been fully charged, but there is no risk of overcharging while charged in trickle charging rate.

If NiMH batteries of PDT are charged by a power adapter plugged directly to its DC jack for too long, they can sustain a temporary reduction of capacity due to overcharging. A battery left to charge for several weeks may appear to have minimal capacity. This type of failure can be remedied by temporarily depleting the battery of its power and recharging it to rejuvenate it. This condition can be prevented by avoiding overcharging for long periods of time or always using PT016 to charge the batteries of PDT. The PT016 starts the charging process in quick charging rate and switches to trickle charging rate when it detects the battery is fully charged.

## **2.5 Storage and Safety Precautions**

Batteries should be stored in an open circuit condition and placed where there is no risk of accidental shorting or other damage. Although charged NiMH batteries may be left unused for several months, their capacity may be reduced due to back up and internal resistance. If this happens they will require recharging prior to use. NiMH batteries may be stored at temperatures between -4°F and 158°F (-20°C to 70°C), however they may be depleted more rapidly at the high end of this range.

## Chapter 3 Operation

The system of PDT may operate in various modes for different purposes. The figure below shows the operating flow of the PDT.

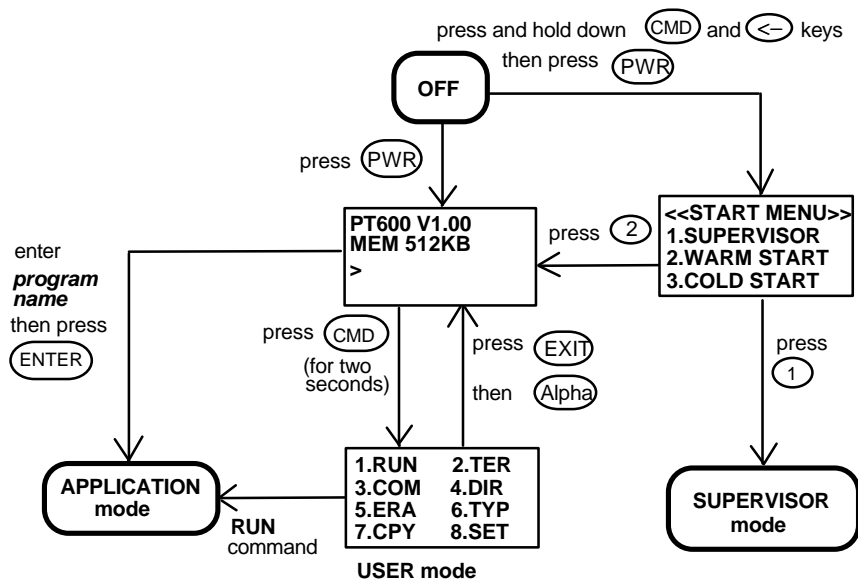

System configurations are categorized in two groups, users can select “8.SET” command in User mode to set general system configurations or enter Supervisor mode to set advanced system configurations. The **Supervisor mode** is also protected with password checking to prevent unauthorized personnel from changing the system configuration.

*(for PT600 detail information please refer to PT600 Technical Binder)*

### 3.1 Ready Mode

The PDT performs a Power-On-Test and Warm-Start when it is switched on. After the Warm Start, the system enters Ready mode and shows the Ready mode prompt.

Ready mode prompt

```
PT600 Vx.xx  
MEM 4608 KB  
>
```

The first line indicates the model code and version number (e.g. V1.00). The second line shows the size of the total installed RAM (i.e. 4608 KB). The third line prompts a ">" which indicates that the terminal passed the Power-on-test and is ready to be used.

## 3.2 User Mode and System Commands

There are eight system commands: RUN, TER, COM, DIR, ERA, TYP, CPY, and SET. Each command can be invoked through menu-selection in **User mode**. User can press [CMD] key for two seconds in **Ready mode** to enter **User mode**.

User mode prompt

```
(1) RUN  (2) TER  
(3) COM  (4) DIR  
(5) ERA  (6) TYP  
(7) CPY  (8) SET
```

Select the corresponding number, 1-8, or press [←] and [→] to highlight a command then hit [ENT] to select a system command. Pressing the [EXIT] key (hit [CMD], then [ALPHA]) returns to **Ready mode**.

### RUN

When invokes the **RUN** command, the system shows a screen as right and you may press the [→] key to toggle the loaded program and hit [ENT] to run the program. The program may also be executed on the PDT by entering the program name directly in Ready mode.

```
< RUN PROGRAM>  
NULL
```

### TER

This command puts the PDT in either terminal emulation mode or FormCaching application mode depending on which function you select. Please see chapter 4 for detail on how to configure and use FormCaching. In terminal emulation mode, the PDT serves as a dumb terminal to transmit data to or receive data

from a Host computer. In this mode, data input from bar code reader or keyboard is displayed on screen and output to RS-232 port. Data received from the serial port is displayed on the LCD screen. Communication parameters, such as baud rate, data bits, parity, stop bits and flow control, must be set to be compatible with the destination in order to send data properly.

**COM** This command puts the PDT in Kermit server mode. The following indicates the available Kermit commands at the Host/PC side:

<u>Command</u>	<u>Description</u>
<b>send <i>filename</i></b>	Send a file from the Host/PC to PDT and store it in the PDT's RAM disk.
<b>get <i>filename</i></b>	Get a file from the PDT to the Host/PC disk.
<b>remote dir</b>	List files of the PDT's RAM disk.
<b>remote del <i>filename</i></b>	Delete a data file stored in the PDT's RAM disk.

Make sure set the PDT communication parameters to match the host/PC system before proceeding data communication. Hit [CMD] then [ALPHA] keys to return to the Ready mode.

**DIR** This command shows the files in the RAM disk with the following information:

- The list of file names stored in the RAM DISK.
- The size of program execution area.
- The amount of free RAM DISK space left.

**ERA** This command deletes a file from RAM disk of PDT. After the file has been deleted, it can not be recovered.

< ERASE FILE > SCAN.EXE
----------------------------



**TYP** This command dumps the content of a file on the PDT's LCD. The content of the file will be displayed 128 (16 character x 8 line) characters at a time. Press any key to show the next page or hit [CMD] then [ALPHA] keys to return to **User mode prompt**. If you try to display a program or binary file, you may only see unintelligible characters.

```
< TYPE FILE >
SCAN.DAT
```

**CPY** This command allows users to make copy of data from a source device to a destination device. The source device may be a file, COM(serial input), CON(keyboard), and the destination device may be a file, COM(serial output), CON(LCD display).

<u>Source</u>	<u>Dest.</u>	<u>Function</u>
file1	file2	copy file1 to file2
file1	COM	output content of file1 to serial port
file1	CON	output content of file1 to LCD
COM	file2	input data from serial port and store in file2
CON	file2	input data from keyboard and store in file2, press [CMD] and then [ALPHA] key to end the data input

**SET** This command allows users to set system date and time, assign laser or pen scanning feature and enable to display power-on logo (see next section).

### 3.3 Configure the Terminal in SET command

There are three categories of general system configuration available in SET command. Select the corresponded number, 1-3, to set system date/time, assign scanning feature and enable power-on Logo display. Hit [CMD] then [ALPHA] keys to return to **User mode prompt**.

```
<SYSTEM SETUP>
1.DATE & TIME
2.SCANNER
3.DISPLAY
```

## **1. DATE & TIME: set system clock/calendar**

When selects “**1.DATE & TIME**” in **SET command menu**, the screen as right will be shown on PDT’s LCD and let you set the system date and time of Real Time Clock chip (RTC). The system date and time can be retrieved in application and used as time stamp for data collection.

DATE-TIME SETUP 1998/01/01 08:00:00
---

The second line shows the current date in the format YYYY/MM/DD (year/month/day). If you want to reset the system date to January 1, 1997, then enter[1][9][9][7],[0][1],[0][1]. Or press [ENT] key to skip the system date setting.

The third line shows the current time. The way to set system time is similar to set system date described above. The format of system time is expressed in 24 hour of HH:MM:SS (hour:minute:second).

## **2. SCANNER: set reading mode of built-in**

The system software of PDT decodes all major bar code symboloies including Code 39, Code 128, Codabar, Code 93, I25, EAN, UPC, China Post code, etc. Use the [→] key to toggle among selection in each category, then press [ENT] to confirm.

**SCANNER** Enable / disable bar code decoding.  
**PEN SCAN KEY** When pen scanner is used on PT600, user can setup whether pressing trigger key to enable pen scanner. If **ENABLE** is selected, user must press and hold down trigger to scan barcode label. If **DISABLE** is selected, user can directly scan barcode label without pressing trigger key.  
Enable / Disable

## **3. DISPLAY: Enable/disable power-on logo display**

**ENABLE** Show system logo when power-on.  
**DISABLE** Do not show system logo when power-on.

### 3.4 Upload/Download by ESC Command

The way to make file upload/download by Kermit server described in section 3.2 will need the operator to set the PDT to Kermit server mode by invoking user command “3.COM” in User mode or calling system function in application program.

The hardware and software of PDT is designed that the unit can be waken up (turned on) by input from serial port. Besides the previous method to upload/download file, the PDT can also be instructed to process the data communication by remote ESC commands through built-in MULTI communication protocol.(please refer to PT600 Technical Binder for detail information)

After linking the PDT to a PC/host through RS232 interface a communication program running on host first sends a few of dummy bytes to the PDT and delay for about 500 mini-second to remote wake up the unit if it is off. Then the program can send out a data pack of a remote ESC command that matches the MULTI protocol to the PDT and instruct the terminal for certain process.

For instance, the terminal will automatically execute the system routine to upload a file after receiving the valid “File upload” ESC command. Meanwhile the program running on the host should follow the control flow of MULTI protocol and process to receive the data.

For detailed description of each ESC command and protocol, please see the *PT600 Programming Reference Manual*.

## Chapter 4 Built-in Application: FormCaching

The system of PDT includes a built-in application, FormCaching, that allows user to create a data entry application by specifying field prompt, type, length, input method and delimiter,....etc. without writing program and loading to the terminal.

### 4.1 Specification of FormCaching

DATA FIELD DEFINITION: maximum field number=8			
	<i>Category</i>	<i>Range</i>	<i>Description</i>
1	FIELD PROMPT	max.16 characters	set field prompting
2	MIN/MAX DATA LENGTH	1-32	set minimum field length and maximum field length
3	DATA TYPE	1.NUMERIC 2.ALPHANUM	numeric data (0~9) or alphanumeric data (20H~FCH)
4	DEVICE TYPE	1.KEY ONLY 2.SCAN ONLY 3.BOTH	input by keyboard only, bar code scanning only or both
DATA RECORD DEFINITION			
	<i>Category</i>	<i>Range</i>	<i>Description</i>
5	BETWEEN FIELD	1.Append screen 2.Clear screen	specify to clear or append screen between two fields
6	FIELD DELIMITER	1., 2. ; 3.Space 4.Tab	assign field delimiter
7	RECORD DELIMITER	1.CR 2.LF 3.CRLF	assign record delimiter
8	DATE STAMP FIELD	1:NONE 2.YYYYMMDD 3.MMDD 4.MMDDYYYY 5.DDMM 6.DDMMYYYY	specify format of Date stamp
9	TIME STAMP FIELD	1:NONE 2.HHMM 3.HHMMSS	specify format of Time stamp
9	FIELD DELAY	0-6	specify time delay between each record input in second

## 4.2 How to Create a FormCaching

You will need to enter Supervisor mode and select “4.FORM” category in order to set the configuration of FormCaching (refer to the *PT600 Programming Reference Manual* for how to enter the Supervisor mode). After selecting the “4.FORM” in Supervisor mode, the screen will show as above. The system will first ask user to specify four categories of the field specification including *field prompt*, *data length*, *data type* and *device type* of each data field. After completion to define all data fields, the user should hit [CMD] then [ALPHA] keys to end the setup of field specification. This step also determines the number of fields in each record and you may continue to set the rest six categories of record specification including *between field*, *field delimiter*, *record delimiter*, *date stamp field*, *time stamp field* and *field delay*.

FORM CACHING 1:YES 2:NO OTHER:EXIT
---

When the FormCaching application is executed, a data file named FORM.DAT will be created to store data. The system will not allow the user to redefine FormCaching if the FORM.DAT is existed. It is necessary to delete the FORM.DAT in order to change the configuration of FormCaching.

## 4.3 How to Run FormCaching

When FormCaching is enabled, the built-in application can be run by selecting “2.TER” command in User mode and then select “2.FORM CACHING”. The FormCaching application will follow the setting as defined to display prompting, get input and store data in the file named FORM.DAT. Hit [CMD] then [ALPHA] keys to end FormCaching and return to system Ready mode. User may use [←] key to browse a previous data record, [→] key to step to next record, press [C] key to clear the record and then input new values of every field of this record.

After collecting data, the FORM.DAT file can be uploaded to host either by invoking kermit server in User mode described in section 3.2 or remote ESC command described in 3.4.

#### 4.4 Default Setting of FormCaching

In default, the FormCaching is initialized with settings as shown in the table below.

DATA FIELD SPECIFICATION: field number=2		
<i>Category</i>		<i>Setting</i>
Field #1	FIELD PROMPT	ITEM:
	DATA LENGTH	32
	DATA TYPE	ALPHANUM
	DEVICE TYPE	BOTH
Field #2	FIELD PROMPT	QTY:
	DATA LENGTH	4
	DATA TYPE	NUMERIC
	DEVICE TYPE	KEY ONLY
DATA RECORD SPECIFICATION		
<i>Category</i>		<i>Setting</i>
	BETWEEN FIELD	Append screen
	FIELD DELIMITER	,
	RECORD FELIMITER	CR
	DATE STAMP FIELD	NONE
	TIME STAMP FIELD	NONE
	FIELD DELAY	0

1998.10.9 edited

**Warning**

**This is a Class A product in a domestic environment this product may cause radio interference in which case the user may be required to take adequate measures.**

## Free Manuals Download Website

<http://myh66.com>

<http://usermanuals.us>

<http://www.somanuals.com>

<http://www.4manuals.cc>

<http://www.manual-lib.com>

<http://www.404manual.com>

<http://www.luxmanual.com>

<http://aubethermostatmanual.com>

Golf course search by state

<http://golfingnear.com>

Email search by domain

<http://emailbydomain.com>

Auto manuals search

<http://auto.somanuals.com>

TV manuals search

<http://tv.somanuals.com>