



UNITED STATES STOVE COMPANY

"Keeping North America Warm Since 1869"



Models: 5824

Owner's Manual

- △ **Please read this entire manual before installation and use of this appliance. Failure to follow these instructions could result in property damage, bodily injury, or even death.**
- △ **Contact your local building or fire officials about restrictions and installation inspection requirements in your area.**
- △ **Save these instructions.**





UNITED STATES STOVE COMPANY • 227 INDUSTRIAL PARK ROAD • SOUTH PITTSBURG, TENNESSEE 37380 • WWW.USSTOVE.COM
For Customer Service: **PHONE: (800) 750-2723** **FAX: (423) 837-2109** **Email: www.customerservice@usstove.com**

Part No.: 851740 rev D

Table of Contents

TABLE OF CONTENTS	2
SAFETY PRECAUTIONS	3
SPECIFICATIONS	4
Heating Specifications	4
Dimensions	4
Electrical Specifications	4
Fuel Considerations.....	4
Safety and EPA Compliance.....	4
INSTALLATION	5
Installation Options	5
Floor Protection	5
Clearances	6
Venting Requirements	7
Maximum Venting Distance	7
Pellet Vent Type.....	7
Pellet Vent Installation	7
Pellet Vent Termination.....	7
Vent Termination Clearances.....	8
Through the Wall Installation	9
Through the Roof/Ceiling Installation.....	9
Outside Air Supply	10
Special Mobile Home Requirements	10
UNDERSTANDING YOUR STOVE	11
OPERATION	12-13
Start-Up Procedure.....	12
Shut Down Procedure.....	12
Daily Operation	13
Safety and Convenience Features	13
MAINTENANCE	13-14
Exhaust System.....	13
Interior Chambers	14
Ash Disposal.....	14
Check and Clean the Hopper	14
Main Door Gaskets.....	14
Blower Motors.....	14
Painted Surfaces	14
Glass.....	14
Fall Start-Up.....	14
Spring Shut Down.....	14
Yearly Servicing	14
TROUBLE SHOOTING	15
REPAIR PARTS DIAGRAM/LIST	16-17
WIRING DIAGRAM	18

Safety Precautions

- △ **IMPORTANT:** Read this entire manual before installing and operating this product. Failure to do so may result in property damage, bodily injury, or even death. Proper installation of this stove is crucial for safe and efficient operation.
- △ Install vent at clearances specified by the vent manufacturer.
- △ Do not connect the pellet vent to a vent serving any other appliance or stove.
- △ Do not install a flue damper in the exhaust venting system of this unit.
- △ Use of outside air is not required for this unit.
- △ Contact your local building officials to obtain a permit and information on any additional installation restrictions or inspection requirements in your area.
- △ Do not throw this manual away. This manual has important operating and maintenance instructions that you will need at a later time. Always follow the instructions in this manual.
- △ This heater is designed and approved for premium hardwood pellet fuel only. Any other type of fuel burned in this heater will void the warranty and safety listing.
- △ Never use gasoline, gasoline-type lantern fuel, kerosene, charcoal lighter fluid, or similar liquids to start or 'freshen up' a fire in this stove. Keep all such liquids well away from the stove while it is in use.
- △ A working smoke detector must be installed in the same room as this product.
- △ Do not unplug the stove if you suspect a malfunction. Turn the stove OFF by pressing  and contact your dealer.
- △ Your stove requires periodic maintenance and cleaning (see "MAINTENANCE"). Failure to maintain your stove may lead to improper and/or unsafe operation.
- △ Disconnect the power cord before performing any maintenance! NOTE: Pressing  to switch the unit "OFF" does not disconnect all power to the electrical components of the stove.
- △ Never try to repair or replace any part of the stove unless instructions for doing so are given in this manual. All other work should be done by a trained technician.
Do not operate your stove with the viewing door open. The auger will not feed pellets under these circumstances and a safety concern may arise from sparks or fumes entering the room.
- △ Allow the stove to cool before performing any maintenance or cleaning. Ashes must be disposed in a metal container with a tight fitting lid. The closed container of ashes should be placed on a non-combustible surface or on the ground, well away from all combustible materials, pending final disposal.
- △ The exhaust system should be checked monthly during the burning season for any build-up of soot or creosote.
- △ Do not touch the hot surfaces of the stove. Educate all children on the dangers of a high-temperature stove. Young children should be supervised when they are in the same room as the stove.
- △ The hopper and stove top will be hot during operation; therefore, you should always use some type of hand protection when refueling your stove.
- △ **A power surge protector is required.** This unit must be plugged into a 110 - 120V, 60 Hz grounded electrical outlet. Do not use an adapter plug or sever the grounding plug. Do not route the electrical cord underneath, in front of, or over the heater. Do not route the cord in foot traffic areas or pinch the cord under furniture.
- △ The heater will not operate during a power outage. If a power outage does occur, check the heater for smoke spillage and open a window if any smoke spills into the room.
- △ The viewing door must be closed and sealed during operation.
- △ Never block free airflow through the open vents of the unit.
- △ Keep foreign objects out of the hopper.
- △ The moving parts of this stove are propelled by high torque electric motors. Keep all body parts away from the auger while the stove is plugged into an electrical outlet. These moving parts may begin to move at any time while the stove is plugged in.
- △ Do not place clothing or other flammable items on or near this stove.
- △ When installed in a mobile home, the stove must be grounded directly to the steel chassis and bolted to the floor. **WARNING—THIS UNIT MUST NOT BE INSTALLED IN THE BEDROOM (per HUD requirements). CAUTION—THE STRUCTURAL INTEGRITY OF THE MOBILE HOME FLOOR, WALL, AND CEILING/ROOF MUST BE MAINTAINED.**
- △ This appliance is not intended for commercial use.

* This appliance is a freestanding heater. It is not intended to be attached to any type of ducting. It is not a furnace.
USSC

Specifications

Heating Specifications

Input Rating	38,500 BTU/hr
Heat Output ¹	30,000 BTU/hr.
Efficiency	78%
Heating Capacity ²	850 sq. ft.
Fuel Burn Rate ³	3.5 lbs./hr. ±5%
Burn Time (lowest setting)	11-1/2 hrs. ±5%
Hopper Capacity	40 lbs.

¹ BTU output will vary depending on the quality of fuel. Use PFI listed fuels for the best results.

² Heating capacity will vary depending on floor plan layout of your home, degree of insulation, and the outside temperature.

³ Pellet size may effect the actual rate of fuel feed and burn times. Fuel feed rates may vary by as much as 20%. Use PFI listed fuel for best results.

Dimensions

Height	33-1/2 in.
Width	18-1/4 in.
Depth	19-1/4 in.

Electrical Specifications

Electrical Rating	110-120 volts, 60 HZ, 4.5 Amps
Watts (maximum)	520 (approx.)

FUEL CONSIDERATIONS

Your Pellet stove is designed to burn premium hardwood pellets that comply with Association of Pellet Fuel Industries standards. (Minimum of 40 lbs density per cubic ft, 1/4" to 5/16" diameter, length no greater than 1.5", not less than 8,200 BTU/lb, moisture under 8% by weight, ash under 1% by weight, and salt under 300 parts per million). Pellets that are soft, that contain excessive amounts of loose sawdust, or that have been or are wet will result in reduced performance. Due to the different fuel densities and sizes, the fuel feed rate may vary. This may require an adjustment to the slider damper setting or the auger feed trim setting on low.

SAFETY AND EPA COMPLIANCE

Your Pellet stove has been safety tested and listed to ASTM E 1509, by OMNI-Test Laboratories, Inc. Portland, Oregon, USA. It is also certified and tested to EPA Phase II requirements.

Installation

INSTALLATION OPTIONS

△ **Read this entire manual before you install and use your pellet stove. Failure to follow instructions may result in property damage, bodily injury, or even death!**

(See specific installation details for clearances and other installation requirements)

A **Freestanding Unit**—Placed on a non-combustible floor surface in compliance with clearance requirements for a freestanding stove installation.

An **Alcove Unit**—Placed on a non-combustible floor surface in compliance with clearance requirements for an alcove installation.

Your Forester stove may be installed to code in either a **conventional** or **mobile home** (see **SPECIAL MOBILE HOME REQUIREMENTS**).

It is recommended that only a authorized technician install your Forester stove, preferably an NFI certified specialist.

IMPROPER INSTALLATION: The manufacturer will not be held responsible for damage caused by the malfunction of a stove due to improper venting or installation. Call (800) 750-2723 and/or consult a professional installer if you have any questions.

FLOOR PROTECTION

This unit must be installed on a non-combustible floor surface. If a floor pad is used, it should be UL listed or equal. The floor pad or non-combustible surface should be large enough to extend a minimum of 6-inches in front, 6-inches on each side, and 1-inch behind the stove (see FIGURE 1).

Floor protection must extend under and 2-inches to each side of the chimney tee for an interior vertical installation (see FIGURE 2). Only an elbow type connection can be used for indoor installation.

Your Forester stove will need a minimum 28" x 31" floor protector.

A Floor Protector of 1 inch thick is recommended for this installation.

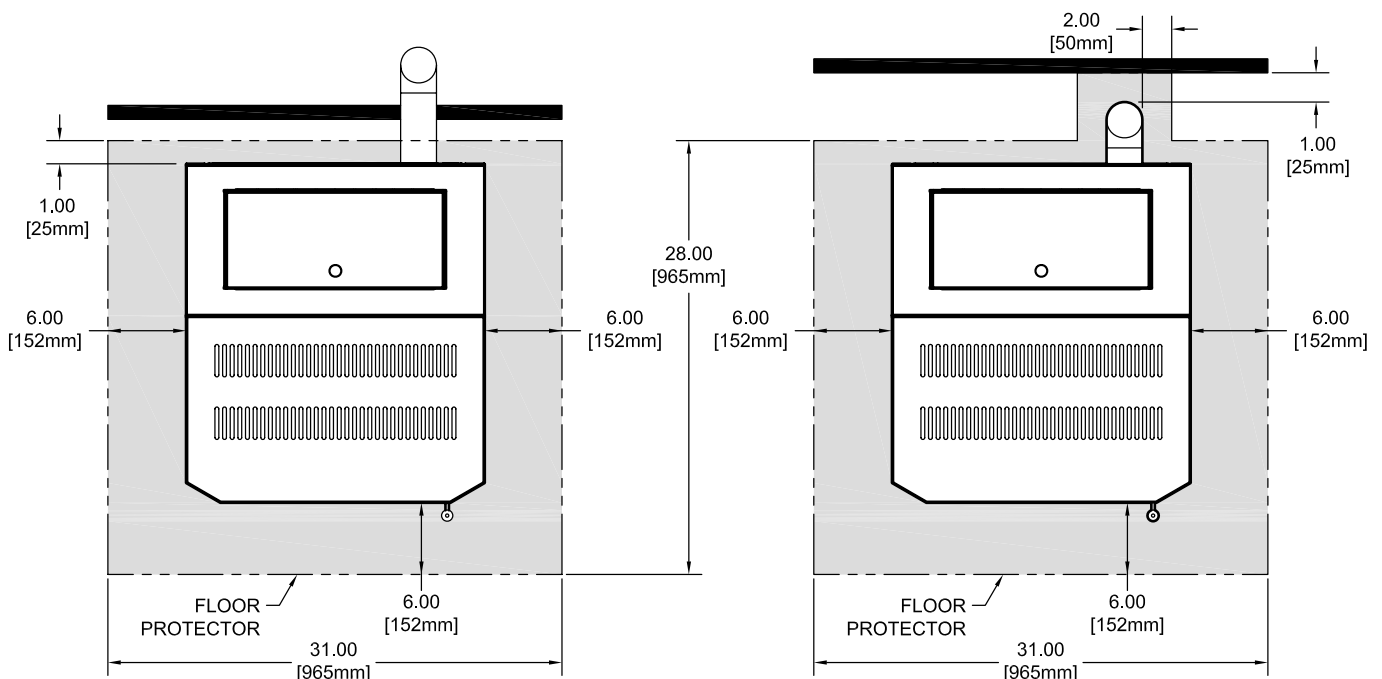

FIGURE 1

FIGURE 2

Installation

CLEARANCES

Your Forester stove has been tested and listed for installation in residential, mobile home, and alcove applications in accordance with the clearances given in FIGURES 3-4 and TABLE 1.

NOTE: Distance "D" on the left-hand side of your Forester stove may need to be greater than the minimum required clearance for suitable access to the control panel.

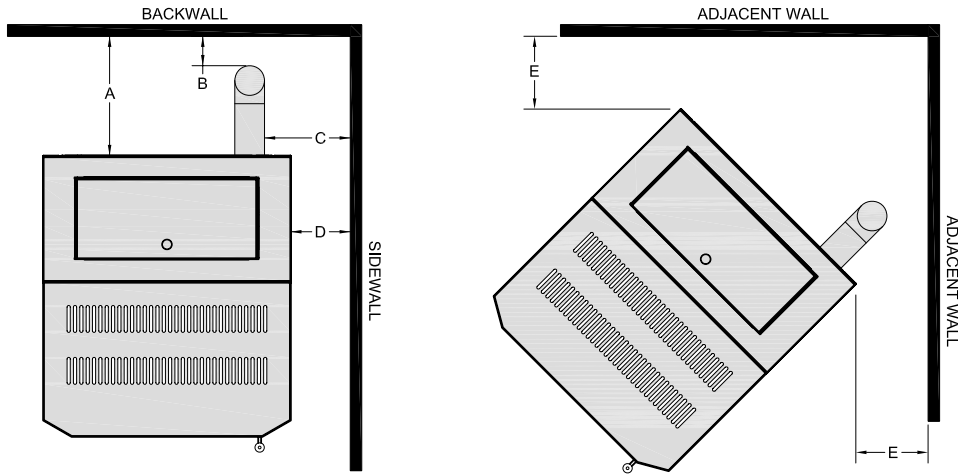

FIGURE 3
SIDEWALL / CORNER
MINIMUM CLEARANCES

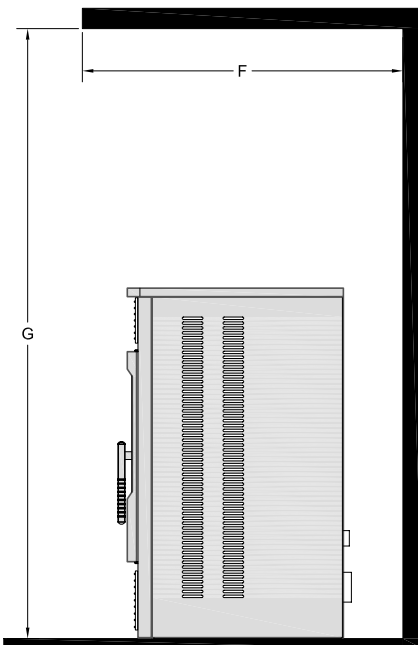

FIGURE 4
MINIMUM ALCOVE CLEARANCES

PARALLEL	A - Backwall to heater	8.00" / 203mm
	B - Backwall to flue	1.00" / 25mm
	C - Sidewall to flue	7.50" / 191mm
	D - Sidewall to edge of unit	4.00" / 100mm
CORNER ALCOVE	E - Adjacent wall to unit	2.00" / 50mm
	F - Alcove depth	25.00" / 635mm
	G - Alcove Height	47.00" / 1194mm
	Alcove Width	26.50" / 673mm

TABLE 1
MINIMUM CLEARANCES
(inches/mm)

Installation

VENTING REQUIREMENTS

- △ Install vent at clearances specified by the vent manufacturer.
- △ Do not connect the pellet vent to a vent serving any other appliance or stove.
- △ Do not install a flue damper in the exhaust venting system of this unit.

The following installation guidelines must be followed to ensure conformity with both the safety listing of this stove and to local building codes.

IMPORTANT! This unit is equipped with a negative draft system that pulls air through the burn pot and pushes the exhaust out of the dwelling. If this unit is connected to a flue system other than the way explained in this manual, it will not function properly.

MAXIMUM VENTING DISTANCE

Installation MUST include at least 3-feet of vertical pipe outside the home. This will create some natural draft to reduce the possibility of smoke or odor during appliance shutdown and keep exhaust from causing a nuisance or hazard by exposing people or shrubs to high temperatures. The maximum recommend vertical venting height is 12-feet for 3-inch type "PL" vent. Total length of horizontal vent MUST NOT exceed 4-feet. This could cause back pressure. Use no more than 180 degrees of elbows (two 90-degree elbows, or two 45-degree and one 90-degree elbow, etc.) to maintain adequate draft.

PELLET VENT TYPE

A UL listed 3-inch or 4-inch type "PL" pellet vent exhaust system must be used for installation and attached to the pipe connector provided on the back of the stove (use a 3-inch to 4-inch adapter for 4-inch pipe). Connection at back of stove must be sealed using Hi-Temp RTV. Use 4-inch vent if the vent height is over 12-feet or if the installation is over 2,500 feet above sea level.

We recommend the use of Simpson Dura-Vent® or Metal-Fab® pipe (if you use other pipe, consult your local building codes and/or building inspectors). Do not use Type-B Gas Vent pipe or galvanized pipe with this unit. The pellet vent pipe is designed to disassemble for cleaning and should be checked several times during the burning season. Pellet vent pipe is not furnished with the unit and must be purchased separately.

PELLET VENT INSTALLATION

The installation must include a clean-out tee to enable collection of fly ash and to permit periodic cleaning of the exhaust system. 90-degree elbows accumulate fly ash and soot thereby reducing exhaust flow and performance of the stove. Each elbow or tee reduces draft potential by 30% to 50%.

All joints in the vent system must be fastened by at least 3 screws, and all joints must be sealed with Hi-Temp RTV silicone sealant to be airtight. The area where the vent pipe penetrates to the exterior of the home must be sealed with silicone or other means to maintain the vapor barrier between the exterior and the interior of the home.

Vent surfaces can get hot enough to cause burns if touched by children. Noncombustible shielding or guards may be required.

Only an elbow type connection can be used for indoor installation.

PELLET VENT TERMINATION

Do not terminate the vent in an enclosed or semi-enclosed area, such as; carport, garage, attic, crawl space, under a sundeck or porch, narrow walkway, or any other location that can build up a concentration of fumes.

The termination must exhaust above the outside air inlet elevation.

The termination must not be located where it will become plugged by snow or other materials.

Do not terminate the venting into an existing steel or masonry chimney.

Installation

VENT TERMINATION CLEARANCES:

- A) Minimum 4-foot clearance below or beside any door or window that opens.
- B) Minimum 1-foot clearance above any door or window that opens.
- C) Minimum 3-foot clearance from any adjacent building.
- D) Minimum 7-foot clearance from any grade when adjacent to public walkways.
- E) Minimum 2-foot clearance above any grass, plants, or other combustible materials.
- F) Minimum 3-foot clearance from an forced air intake of any appliance.
- G) Minimum 2-foot clearance below eaves or overhang.
- H) Minimum 1-foot clearance horizontally from combustible wall.
- I) Must be a minimum of 36-inches above the roof and 24-inches above the highest point or the roof within 10-feet.

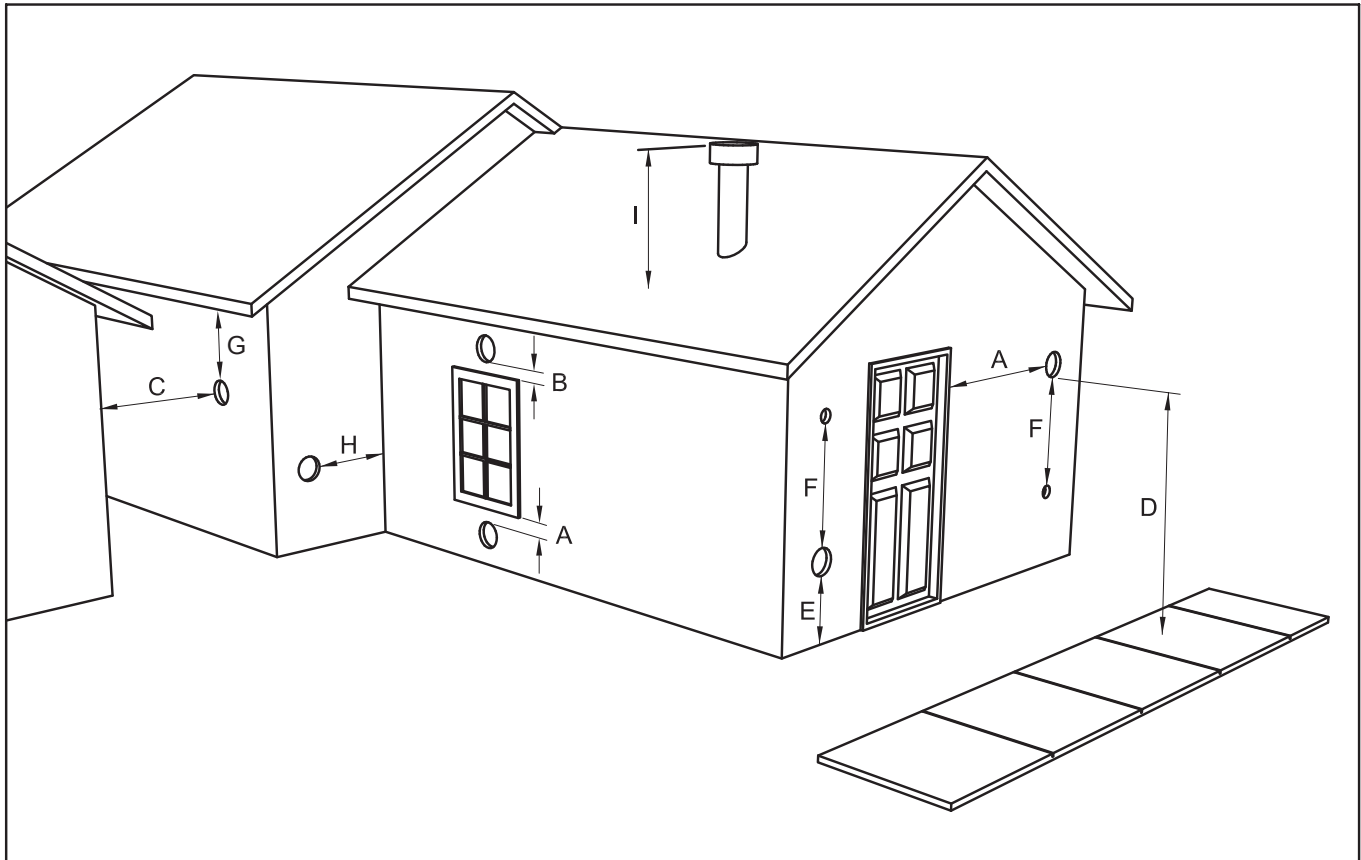

FIGURE 5
VENT TERMINATION CLEARANCES

Installation

THROUGH THE WALL INSTALLATION (RECOMMENDED INSTALLATION)

To vent the unit through the wall, connect the pipe adapter to the exhaust motor adapter. If the exhaust adapter is at least 18-inches above ground level, a straight section of pellet vent pipe can be used through the wall.

Your Forester dealer should be able to provide you with a kit that will handle most of this installation, which will include a wall thimble that will allow the proper clearance through a combustible wall. Once outside the structure, a 3-inch clearance should be maintained from the outside wall and a clean out tee should be placed on the pipe with a 90-degree turn away from the house. At this point, a 3-foot (minimum) section of pipe should be added with a horizontal cap, which would complete the installation (see FIGURE 6).

A support bracket should be placed just below the termination cap or one every 4-feet to make the system more stable. If you live in an area that has heavy snowfall, it is recommended that the installation be taller than 3-feet to get above the snowdrift line. This same installation can be used if your stove is below ground level by simply adding the clean-out section and vertical pipe inside until ground level is reached. With this installation you have to be aware of the snowdrift line, dead grass, and leaves. We recommend a 3-foot minimum vertical rise on the inside or outside of the house.

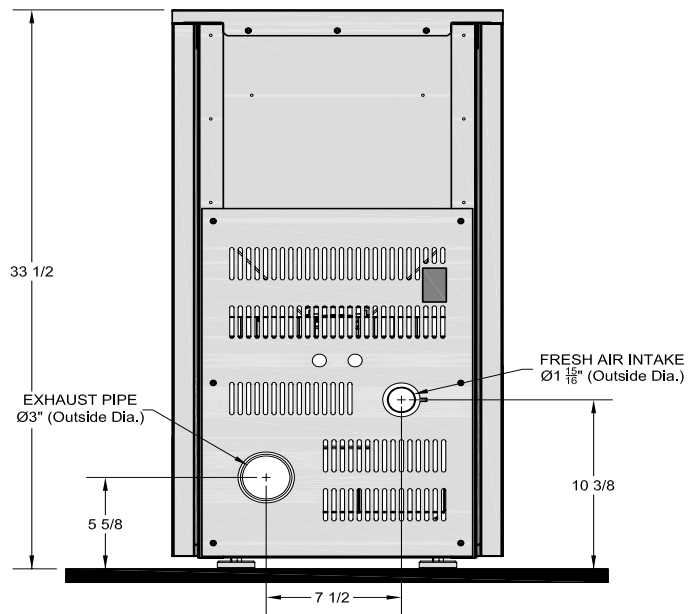

FIGURE 6
TYPICAL THROUGH THE WALL INSTALLATION

The “through the wall” installation is the least expensive and simplest installation. Never terminate the end vent under a deck, in an alcove, under a window, or between two windows. We recommend Simpson Dura-Vent® or Metal-Fab® kits.

THROUGH THE ROOF/CEILING INSTALLATION

When venting the stove through the ceiling, the pipe is connected the same as through the wall, except the clean-out tee is always on the inside of the house, and a 3-inch adapter is added before the clean-out tee.

You must use the proper ceiling support flanges and roof flashing (supplied by the pipe manufacturer; follow the pipe manufacturer’s directions). It is important to note that if your vertical run of pipe is more than 15-feet, the pellet vent pipe size should be increased to 4-inches in diameter.

Do not exceed more than 4-feet of pipe on a horizontal run and use as few elbows as possible. If an offset is required, it is better to install 45-degree elbows rather than 90-degree elbows.

Installation

OUTSIDE AIR SUPPLY (optional, unless installing in a mobile home)

Depending on your location and home construction, outside air may be necessary for optimal performance.

Metal pipe (solid or flexible) must be used for the outside air installation. PVC pipe is NOT approved and should NEVER be used.

A wind shield over the termination of the outside air pipe or a 90-degree elbow or bend away from the prevailing winds MUST be used when an outside air pipe is installed through the side of a building. The outside air termination MUST be at least 1-foot away from the exhaust system termination.

The outside air pipe on your Forester stove is 2" OD. The outside air connecting pipe must be at least 2" ID. The outside air connection used MUST NOT restrict the amount of air available to your stove. The outside air connecting pipe must be as short and free of bends as possible, and it must fit over, not inside, the outside air connection to the stove.

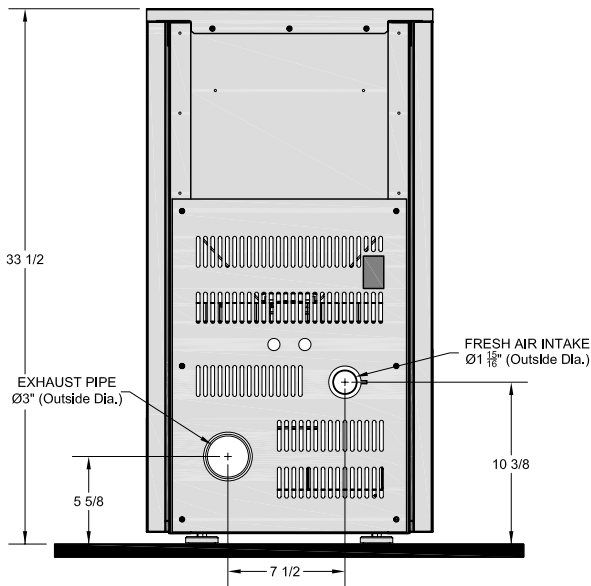

FIGURE 7
EXHAUST/INLET LOCATIONS

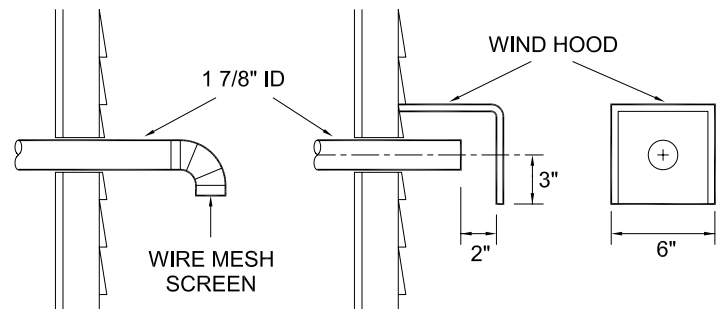

FIGURE 8
TYPICAL FRESH AIR TERMINATION

NOTE: Dimensions from the floor to your stoves inlet/exhaust pipes are approximate and may vary depending on your installation.

SPECIAL MOBILE HOME REQUIREMENTS

△ **WARNING! - DO NOT INSTALL IN A SLEEPING ROOM**

△ **CAUTION! - THE STRUCTURAL INTEGRITY OF THE MOBILE HOME FLOOR, WALL, AND CEILING/ROOF MUST BE MAINTAINED.**

In addition to the previously detailed installation requirements, mobile home installations must meet the following requirements:

- The stove must be permanently attached to the floor.
- The stove must be electrically grounded to the steel chassis of the mobile home with 8 GA copper wire using a serrated or star washer to penetrate paint or protective coating to ensure grounding.
- Vent must be 3 or 4-inch "PL" Vent and must extend a minimum of 36-inches above the roofline of the mobile home and must be installed using a UL listed ceiling fire stop and rain cap.
- When moving your mobile home, all exterior venting must be removed while the mobile home is being relocated. After relocation, all venting must be reinstalled and securely fastened.
- Outside Air is mandatory for mobile home installation. See your dealer for purchasing.
- Check with your local building officials as other codes may apply.

Understanding your stove

How your stove works

Your Forester stove utilizes a vertical auger fuel feed system that is operated by a microprocessor controlled digital circuit board. The digital circuit board allows the vertical auger fuel feed system to run in a timer-based, non-continuous cycle; this cycling allows the auger to run for a predetermined period of seconds. The auger pushes pellets up a chute located in the hopper which in turn falls through another chute into the burnpot. Your stove is equipped with an automatic ignition system that should ignite the fuel within 3 - 5 minutes from pressing the  button. As pellets enter the burnpot and ignite, outside air is drawn across the fuel and heated during the combustion process which is then pulled through the heat exchanger by the exhaust motor or draft fan. As the stove heats up, room air is circulated around the heat exchanger by means of a room air blower, distributing warm air into the room.

The amount of heat produced by the stove is proportional to the rate of the fuel that is burned, and this rate is controlled by the Fuel Control button . In order to maintain combustion of the fuel at a desired rate, the air provided to the burn chamber by the exhaust or draft fan must be maintained precisely. Too little air will result in a flame that is non-energetic or lazy. If the fuel continues to flow with too little air for long enough, the burn pot will fill with too much fuel and the fire will smother out. Too much air will result in a flame that is overactive or aggressive. The flame in this situation is typically very blue at the bottom and resembles a blow torch. If this situation continues, the fuel in the burn pot will be consumed and the fire will go out.

Matching the amount of air required for proper combustion to the fuel rate is the primary objective in effectively burning pellets of various brands and qualities in your stove. The air to fuel ratio can be adjusted to allow almost any fuel quality to burn effectively by following the procedures detailed in the remainder of this manual.

Because a forced draft pressure is required for the combustion process inside your stove, it is extremely important that the exhaust system be properly installed and maintained. And, that when operating your stove, you make sure that the viewing door is properly sealed.

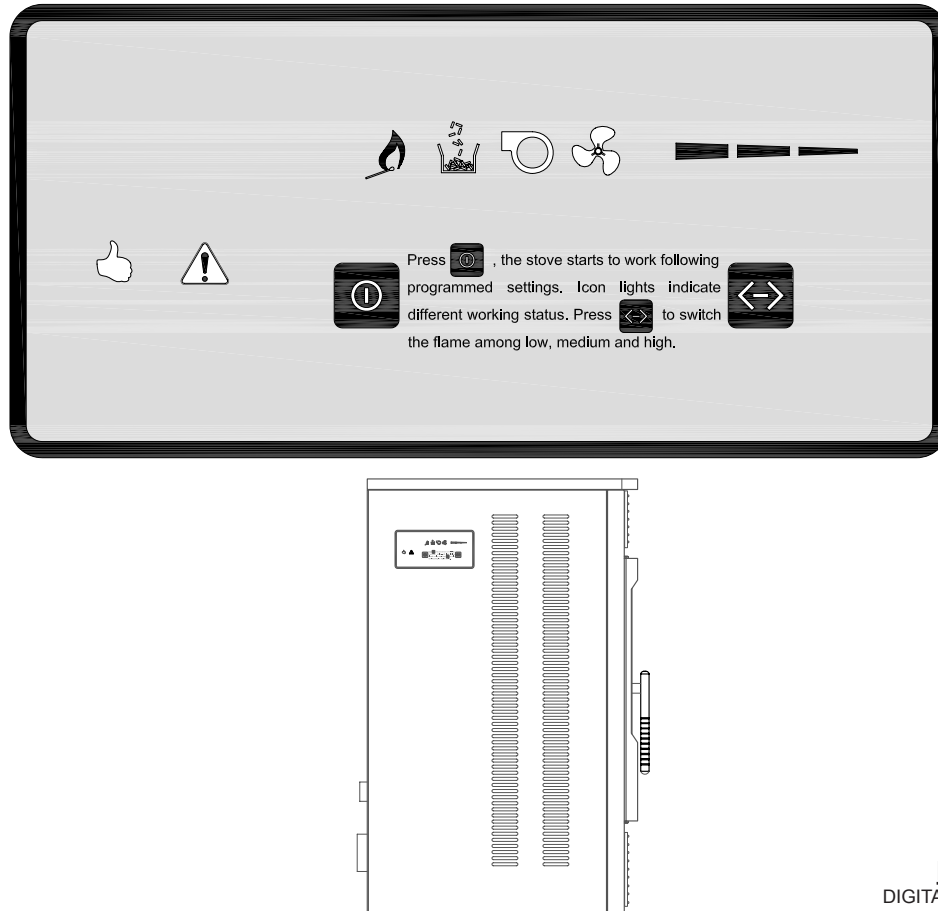





FIGURE 9
DIGITAL CONTROL PANEL

Operation

START-UP PROCEDURE

△ **Never use gasoline, gasoline-type lantern fuel, kerosene, charcoal lighter fluid, or similar liquids to start or “freshen up” a fire in this stove. Keep all such liquids well away from the stove while it is in use.**

- 1.) Verify that the hopper is clean and free of foreign matter including pellet fines and dust.
- 2.) Verify that all of the required exhaust/inlet connections have been made in accordance with this manual and that the stove is plugged into an outlet (an outlet surge protector is highly recommended).
- 3.) Fill the hopper with wood pellets; do not allow any part of the bag or any other foreign material into the hopper, as this may jam the auger.
- 4.) Ensure that all pellet matter is cleared from the hopper seating surface.
- 5.) Close the hopper lid. **The unit WILL NOT feed fuel with the hopper lid open.**
- 6.) Make sure that the viewing door is securely closed (the safety pressure switch will not allow the stove to feed fuel if there is no draft pressure inside the stove).
- 7.) Press the  button on the control pad and then select the highest heat range by pressing the  button.
- 8.) The stove will begin to feed fuel and the **auto-start ignitor** will ignite the fuel in approximately 3 to 5 minutes.

When starting the unit for the first time, the auger mechanism will not be primed with pellets. This will cause the auto-start ignitor to time out and shut the unit down. Pressing the  button again will restart the startup sequence and the stove should ignite properly. However, on some occasions, this process may need to be repeated until ignition depending on fuel size and quality.

As an alternative method to the initial startup, prior to step 6 above, you may add a handful of pellets or add pellets up to the ignition port in the burnpot. Proceed to step 6 thru 8. The pellets should ignite and heater begin proper operation.

Once a consistent flame has been established, you can adjust the heat range  on the control pad to your desired setting, low, medium, or high. (Note: The distribution blower will not function until the heat exchanger in the stove reaches the factory preset temperature).

First Fire: Adjust the heat range to a medium setting and allow the stove to operate in this manner for approximately three (3) hours (or more if necessary), allowing the stove to “cure out” as the paint and oils from the manufacturing process burn off. We recommend that you open doors and windows in your home during this process. Then adjust heat range to your desired setting.

SHUT DOWN PROCEDURE

WARNING: Never shut down this unit by unplugging it from the power source.

Press the  button on the control pad to put the stove in shut down mode. Once this is done, the auger will stop feeding pellets, but the distribution blower and exhaust blower will continue to operate. When the internal temperature of the unit drops below the factory preset temperature, the distribution blower and exhaust blower will cease to operate and the unit will be completely shut down.



The hotter the unit is during its operation, the longer it will take for the stove to complete the shut down cycle. If the stove stays on for more than 2 hours after pressing the  button and you are sure that the fire is out, the stove can be unplugged from the outlet. After approximately 10 seconds, the unit can be re-connected to the power source and the control board will be reset.

Operation

DAILY OPERATION

- △ **The hopper and stove top will be hot during operation; therefore, you should always use some type of hand protection when refueling your stove.**
- △ **Never place your hand near the auger while the stove is in operation.**

In the event of a **power outage**, the stove WILL NOT function. It is very important that unit be vented properly (with outside air), as the natural draft is needed to clear the smoke from the stove during a power outage. If the unit was ON when the power outage occurred, one of the following will take place:

- 1.) If the stove is still warm, it will resume feeding fuel and continue to operate normally. If the fire has gone out, you will have to press the  button and then the  button again to begin a new start-up sequence.
- 2.) If the stove has cooled-off, it will reset to its **OFF** condition. At this point, you may press the  button and the unit will begin a new start-up sequence.

NOTE: The unit will also shut down in the event of an exhaust blower failure; if this is the case, the unit will not re-start and you must contact Customer Service at (800) 750-2723.

SAFETY AND CONVENIENCE FEATURES

Your stove includes an **auto-start igniter** as a standard feature. The use of other fire starter materials (wood chips, starter gel, etc.) is not necessary. By simply pressing the  button on the digital control panel, your stove will begin to feed fuel and automatically start within 3 to 5 minutes.

For safety, this stove incorporates a **safety pressure switch** that helps ensure that everything is in proper working order before feeding fuel to the burn pot. Because the stove works using an induced draft pressure, the stove will not continue to operate if the viewing door is left open; or if the exhaust blower fails or the exhaust system is blocked.

The **temperature limit control** (Thermodisc) will prevent your stove from operating at abnormally high temperatures. Should the stove temperature reach the factory pre-set limit, 200°F(93°C), the temperature limit control will automatically stop the auger feed rate until the temperature returns to a normal condition.

Maintenance

- △ **Failure to clean and maintain this unit as indicated can result in poor performance and safety hazards.**
- △ **Unplug your stove's electrical cord prior to removing the back panel or opening the exhaust system for any inspection, cleaning, or maintenance work.**
- △ **Never perform any inspections, cleaning, or maintenance on a hot stove.**
- △ **Do not operate stove with broken glass , leakage of flue gas may result.**

EXHAUST SYSTEM

The by products of combustion contain small particles of fly ash. Fly ash will collect in the exhaust venting system and restrict the flow of flue gases. Incomplete combustion, such as during startup, shutdown, or incorrect operation of the stove will lead to soot formation which will collect in the exhaust system. Therefore, it is important that the exhaust system be **inspected and cleaned at least monthly** during the burning season.

Check the clean out tees periodically to determine the required cleaning schedule. 3 or 4-inch chimney brushes are available for chimney cleaning. If the exhaust system or outside air pipes have screens on them, frequently clean the screen. A plugged screen will shut off combustion air and cause a fire to die or burn poorly.

Maintenance

INTERIOR CHAMBERS

Periodically remove and clean the burnpot and the area inside the burnpot housing. In particular it is advisable to clean out the holes in the burnpot to remove any build up that may prevent air from moving through the burn pot freely.

If a vacuum is used to clean your stove, we suggest using a vacuum designed for ash removal. Some regular vacuum cleaner (i.e. shop vacs) may leak ash into the room.

ASH DISPOSAL

Ashes should be placed in a metal container with a tight fitting lid. The closed container of ashes should be placed on a noncombustible floor or on the ground, well away from all combustible materials, pending final disposal. If the ashes are disposed of by burial in soil or otherwise locally dispersed, they should be retained in the closed container until all cinders have been thoroughly cooled.

CHECK AND CLEAN THE HOPPER

Check the hopper periodically to determine if there is any sawdust or pellets that are sticking to the hopper surface. Clean as needed.

DOOR AND GLASS GASKETS

Inspect the main door and glass window gaskets periodically. The main door may need to be removed to have frayed, broken, or compacted gaskets replaced by your authorized "Forester" dealer.

BLOWER MOTORS

Clean the air holes on the motors of both the exhaust and distribution blowers annually. Remove the exhaust blower from the exhaust duct and clean out the internal fan blades as part of your fall start-up.

PAINTED SURFACES

Painted surfaces may be wiped down with a damp cloth. If scratches appear, or you wish to renew your paint, contact your authorized "Forester" dealer to obtain a can of suitable high-temperature paint.

GLASS

We recommend using a high quality glass cleaner. Should a build up of creosote or carbon accumulate, you may wish to use 000 steel wool and water to clean the glass. In the event you need to replace the glass, only high temperature ceramic glass of the correct size and thickness may be used. Contact your authorized "Forester" dealer to obtain this glass.

FALL START UP

Prior to starting the first fire of the heating season, check the outside area around the exhaust and air intake systems for obstructions. Clean and remove any fly ash from the exhaust venting system. Clean any screens on the exhaust system and on the outside air intake pipe. Turn all of the controls on and make sure that they are working properly. This is also a good time to give the entire stove a good cleaning throughout.

SPRING SHUTDOWN

After the last burn in the spring, remove any remaining pellets from the hopper and the auger feed system. Scoop out the pellets and then run the auger until the hopper is empty and pellets stop flowing (this can be done by pressing the "ON" button with the viewing door closed). Vacuum out the hopper. Thoroughly clean the burnpot, and firebox. It may be desirable to spray the inside of the cleaned hopper with an aerosol silicone spray if your stove is in a high humidity area. The exhaust system should be thoroughly cleaned.

YEARLY SERVICING

A yearly servicing and cleaning by your authorized "Forester" dealer is recommended. A fee may be charged for this service.

Trouble Shooting

- △ **Disconnect the power cord before performing any maintenance! NOTE: Pressing the OFF button does not disconnect all power to the electrical components of the stove.**
- △ **Never try to repair or replace any part of the stove unless instructions for doing so are given in this manual. All other work should be done by a trained technician.**

PROBLEM	CAUSE: Lack of combustion air intake.
Orange, lazy flame_excessive fuel build-up in the burnpot	<ul style="list-style-type: none"> • Clean out the burnpot. • Make sure that the viewing door is closed and sealed properly. If not, check or replace door gaskets. • Check that all outside connections are clear of any obstructions. • Check the exhaust system; clean as needed.

PROBLEM	CAUSE: Burnpot burns out of fuel
<p>Fire goes out or stove shuts down.</p> <p>A. Three lights are bright and flashing.</p> <p>B. Three lights are bright but not flashing</p> <p>C. The RED light is bright and flashing, but the other are not.</p> <p>D. Three lights are not bright.</p>	<p>A. Auger system is jammed or there is a "bridging" of the fuel in the hopper, preventing fuel from flowing into the auger feed system. Check that the Auger motor is functioning. Check wiring and the auger to motor connection.</p> <p>B. Hopper is empty, refill the hopper.</p> <p>C. The high temperature thermodisc has tripped. Check the wiring connections. Possibly replace thermodisc.</p> <p>D. Loss of power.</p> <p>Other possible causes/solutions:</p> <ul style="list-style-type: none"> • Loss of draft pressure. Make sure that the viewing door is closed and sealed properly. If not, check and/or replace door gaskets. Check that all outside connections are clear of any obstructions. Check the exhaust system; clean as needed. • Check that the pressure switch connection to the firebox is free of ash or clear of obstructions.

PROBLEM	CAUSE: No power or Auto-Start Igniter fails to ignite the fuel in the burnpot.
<p>Stove does not start a fire when the  button is pushed</p>	<ul style="list-style-type: none"> • Make sure power is supplied to stove. • Turn the stove OFF. Clear the unburnt fuel from the burnpot and try again. • Check the pellet quality. Replace if moist, wet, or dirty. • Loss of draft pressure. Make sure that the viewing door is closed and sealed properly. If not, check and/or replace door gaskets. Check that all outside connections are clear of any obstructions. Check the exhaust system; clean as needed. • Check that the pressure switch connection to the firebox is free of ash or clear of obstructions. • Check that the auto-start igniter is not blocked with ash or soot. • The auto-start igniter gets "red hot" during start-up. If you can not visibly see the igniter glowing during start-up, then the igniter may need to be replaced or there is a problem with the electrical control system.

PROBLEM	CAUSE: Stove is overheating. The stove has been working too long or room temp. is too high
Two lights are bright, the feeding light is off, and meanwhile the orange light is bright	<ul style="list-style-type: none"> • Allow stove to shutdown automatically, then restart.

PROBLEM	CAUSE: The burnpot is positioned incorrectly.
<p>A. Stove does not start when  is pressed.</p> <p>B. Prolonged ignition time with excess smoke.</p> <p>C. Burning is not active.</p>	<ul style="list-style-type: none"> • Put burnpot in correct position, as indicated by the slot on the burnpot.

Parts Diagram

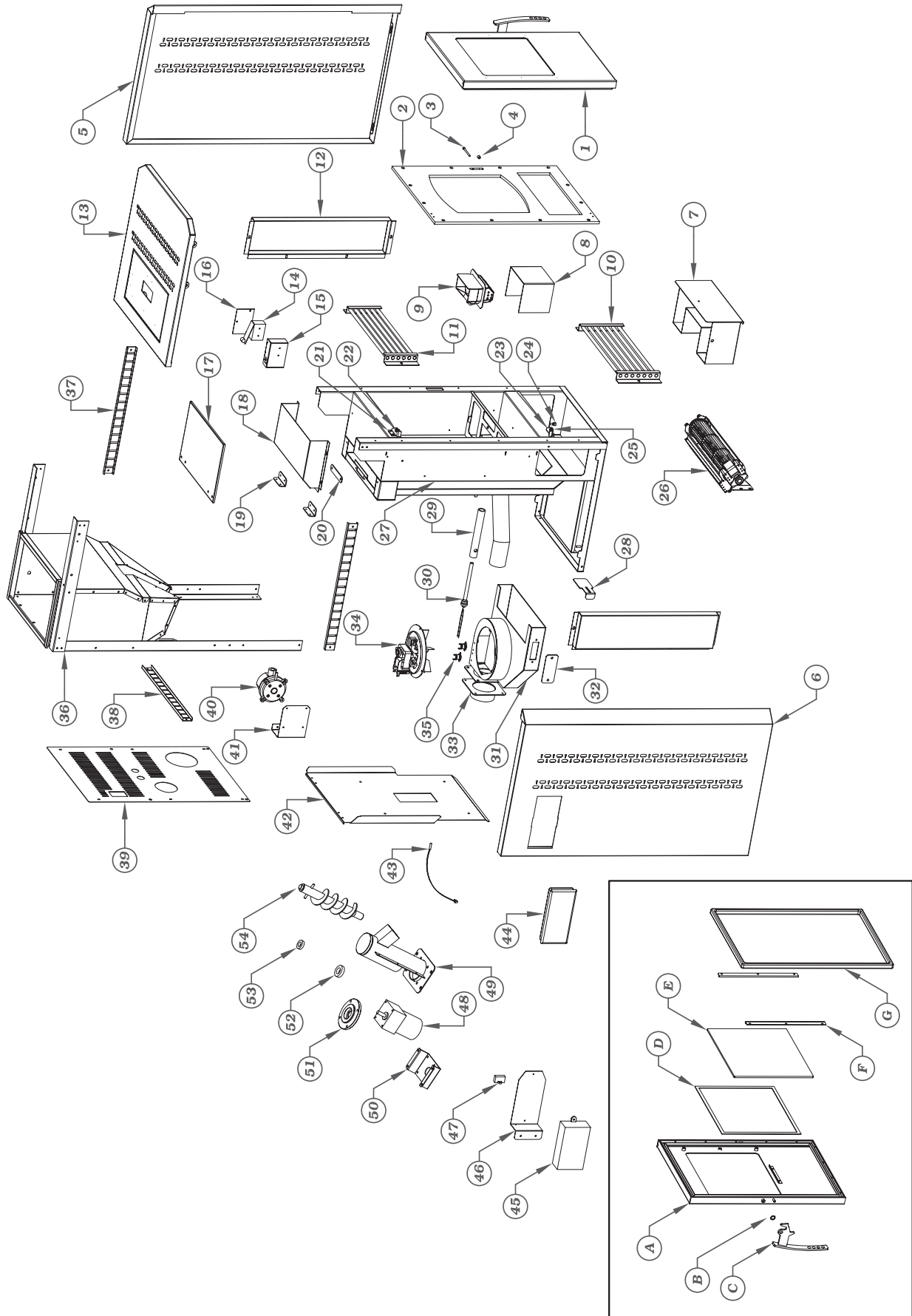

PARTS LIST

5824

Item	Part No.	Title	Qty.	Item	Part No.	Title	Qty
1	891603	Door Frame Assy. (5824-05-01-00)	1	27	891631	Firebox Weldment (5824-01-01-00)	1
A	891604	Door Frame Wldmt (5824-05-00)	1	28	891632	Vent Slides (5824-01-18)	1
B	891605	Nylon Shim (5824- 08-01)	1	29	891633	Ignitor Sleeve (5824-02-12)	1
C	891606	Door Hndle Wldmt (5824-05-02-00)	1	30	80564	Ignitor Assembly (5824-21-00)	1
D	88139	Glass Gasket (5824-09-00)	1	31	891634	Exhaust Hsg Wld (5824-01-01-11-00)	1
E	88140	Glass (5824-05-04)	1	32	891635	Exhast Maint. Cover (5824-01-16-01)	1
F	891607	Glass Retainer (5824-05-01-09)	2	33	891636	Smoke Weldment (5824-01-09-00)	1
G	88141	Door Gasket (5824-08-00)	1	34	80565	Exhaust Motor Assy (5824-01-08)	1
2	891608	Firebox Frt. Panel (5824-01-01-13)	1	35	80566	125°F(52°C) Sensor (5824-22-00)	2
3	891609	Door Hook Pin (5824-01-15)	1	36	891637	Hopper Frame (5824-02-01-00)	1
4	891610	Hook Pin Tube (5824-01-16)	1	37	891638	L/R Wiring Guide Rail (5824-02-03)	2
5	891611	Side Wall Panel (5824-08)	1	38	891639	Back Wiring Guide Rail (5824-02-04)	1
6	891612	Left Wall Panel (5824-09)	1	39	891640	Back Panel (5824-10)	1
7	891613	Ash Pan Weldment (5824-01-02-00)	1	40	80567	Pressure Switch (5824-20-00)	1
8	891614	Burnpot Support (5824-01-01-04)	1	41	891641	Support Pressure Sw. (5824-02-06)	1
9	891615	Burnpot (5824-01-10-00)	1	42	891642	Insulation Panel (5824-01-04-01)	1
10	891616	Air-In Grid (5824-07-00)	1	43	80568	198°F(92°C) Sensor (5824-23-00)	1
11	891617	Air-Out Grid (5824-06-00)	1	44	80569	Circuit Board (5824-18-00)	1
12	891618	Insulation Cover (5824-01-03)	1	45	80570	Power Supply Box (5824-17-00)	1
13	891619	Top Panel Assy. (5824-03-00)	1	46	891643	Support, Pwr Sply Box (5824-02-05)	1
14	80562	Microswitch (5824-19-00)	1	47	80571	Capacitance (5824-16-00)	1
15	891620	Micro-sw Hsg-1 (5824-03-01-03-01)	1	48	80572	Motor (5824-15-00)	1
16	891621	Micro-sw Hsg-2 (5824-03-01-03-02)	1	49	891644	Feed Tube Wldmt (5824-02-02-01-00)	1
17	891622	Top Insulation Panel (5824-01-06)	1	50	891645	Support, Motor (5824-02-02-01-09)	1
18	891623	Top Air Guide Cover (5824-01-07)	1	51	891646	Feed Tube Cover (5824-02-02-01-04)	1
19	891624	Support, Top Air Guide (5824-01-05)	2	52	891647	Big Bearing (5824-11-00)	1
20	891625	Maintenance Panel (5824-01-17)	1	53	891648	Small Bearing (5824-13-00)	1
21	891626	Upper Hinge (5824-01-11-01)	1	54	891649	Auger Weldment (5824-02-02-01-05)	1
22	891627	Uppr Hng Fixing Pin (5824-01-11-02)	1	N/S	891675	Vermiculite Board Front W/Cutout	1
23	891628	Lower Hinge (5824-01-12)	1	N/S	891685	Vermiculite Board Front Top	1
24	891629	Lower Hinge Pin (5824-01-14)	1	N/S	891686	Vermiculite Board Sides	2
25	891630	Hinge Sleeve (5824-01-13)	1				
26	80563	Distribution Motor Assy (5824-11-00)	1				

Wiring Diagram

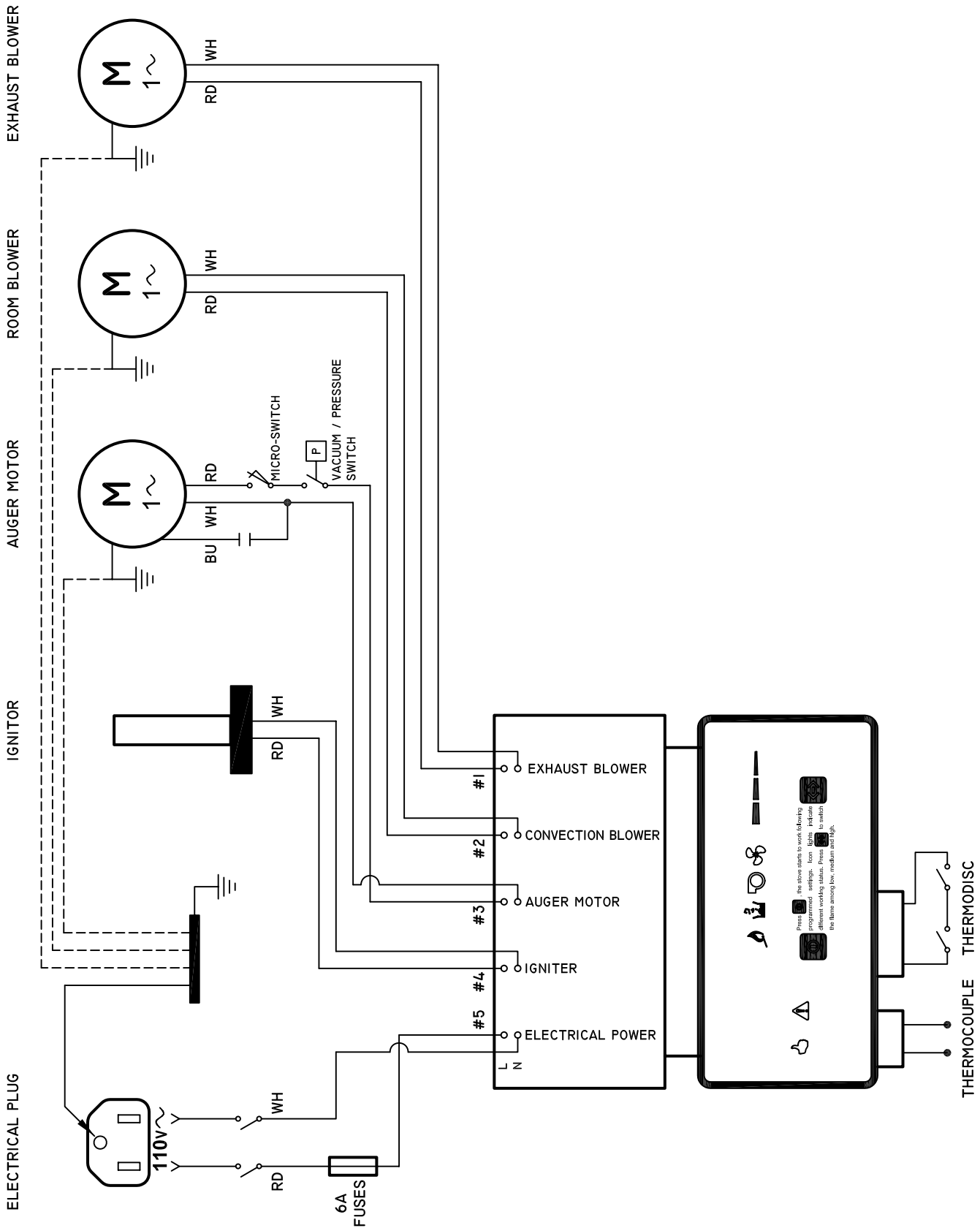

HOW TO ORDER REPAIR PARTS

THIS MANUAL WILL HELP YOU OBTAIN EFFICIENT, DEPENDABLE SERVICE FROM YOUR FORESTER, AND ENABLE YOU TO ORDER REPAIR PARTS CORRECTLY.

KEEP THIS MANUAL IN A SAFE PLACE FOR FUTURE REFERENCE.

WHEN WRITING, ALWAYS GIVE THE FULL MODEL NUMBER WHICH IS ON THE NAMEPLATE ATTACHED TO THE HEATER.

WHEN ORDERING REPAIR PARTS, ALWAYS GIVE THE FOLLOWING INFORMATION AS SHOWN IN THIS LIST:

1. THE PART NUMBER
2. THE PART DESCRIPTION
3. THE MODEL NUMBER: 5824
4. THE SERIAL NUMBER: _____



United States Stove Company
227 Industrial Park Road
P.O. Box 151
South Pittsburg, TN 37380
(800) 750-2723
WWW.USSTOVE.COM

Free Manuals Download Website

<http://myh66.com>

<http://usermanuals.us>

<http://www.somanuals.com>

<http://www.4manuals.cc>

<http://www.manual-lib.com>

<http://www.404manual.com>

<http://www.luxmanual.com>

<http://aubethermostatmanual.com>

Golf course search by state

<http://golfingnear.com>

Email search by domain

<http://emailbydomain.com>

Auto manuals search

<http://auto.somanuals.com>

TV manuals search

<http://tv.somanuals.com>