

**OWNERS MANUAL
 INFRARED CONSTRUCTION HEATERS**

**Models
 SPC-15R/15R SPC-30R/30R**

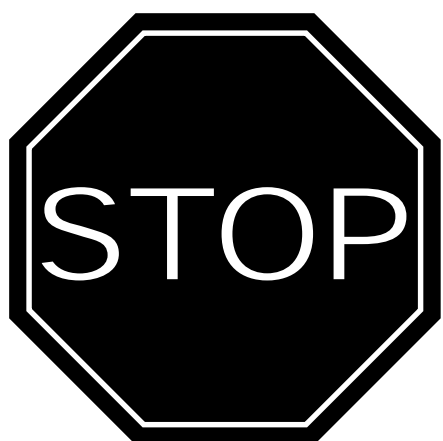

QUESTIONS?

MISSING / DAMAGED PARTS

Please do not return this product to the store.

If a part is damaged or missing, simply e-mail us at php@allpro-heaters.com, or visit our website at <http://allpro-heaters.com>, or call our Customer Service Department at (888) 619-7060.

We will be happy to assist you!

You can register your heater on line at <http://allpro-heaters.com/warranty>.

TABLE OF CONTENTS

 WARNINGS	2
HEATER SPECIFICATIONS	2
SAFETY PRECAUTIONS	3
OPERATING PRECAUTIONS	3
ODOR FADE WARNING	4
ASSEMBLY INSTRUCTIONS	5
OPERATING INSTRUCTIONS	7
SERVICING	8
PARTS BREAKDOWN	9
WARRANTY	10
SERVICE CENTERS	10
WARRANTY REGISTRATION	11

RETAIN THESE INSTRUCTIONS FOR FUTURE REFERENCE

Models

SPC-15R/15R SPC-30R/30R

HEATER SPECIFICATIONS

Type of Gas:	For use with Propane Only	
Gas Supply Pressure to regulator:	Maximum: Bottle Pressure	Minimum: 20 psi (1.37 bar)
Regulator out:	10 - 18 psi (.68 bar - 1.2 bar)	
Minimum Ambient Temp. Rating	0°F (-17.8°C)	

Model:	SPC-15R / 15R	SPC-30R/ 30R
Rating:	10,000 - 15,000 Btu/hr (3.0 - 4.4 kW)	20,000 - 30,000 Btu/hr (5.8 - 8.8 kW)
Ignition:	Match Light	Piezo Ignition
Fuel Consumption:	.5 - .7 #/hr (.23 - .32 kg/hr)	.5 - 1.3 #/hr (.23 - .59 kg/hr)

WARNINGS

YOUR SAFETY IS IMPORTANT TO YOU AND TO OTHERS, SO PLEASE READ THESE INSTRUCTIONS BEFORE YOU OPERATE THIS HEATER.

GENERAL HAZARD WARNING:

FAILURE TO COMPLY WITH THE PRECAUTIONS AND INSTRUCTIONS PROVIDED WITH THIS HEATER, CAN RESULT IN DEATH, SERIOUS BODILY INJURY AND PROPERTY LOSS OR DAMAGE FROM HAZARDS OF FIRE, EXPLOSION, BURN, ASPHYXIATION, CARBON MONOXIDE POISONING, AND/OR ELECTRICAL SHOCK.

ONLY PERSONS WHO CAN UNDERSTAND AND FOLLOW THE INSTRUCTIONS SHOULD USE OR SERVICE THIS HEATER.

IF YOU NEED ASSISTANCE OR HEATER INFORMATION SUCH AS AN INSTRUCTIONS MANUAL, LABELS, ETC. CONTACT THE MANUFACTURER.

WARNING: NOT FOR HOME OR RECREATIONAL VEHICLE USE

 WARNING: FIRE, BURN, INHALATION, AND EXPLOSION HAZARD. KEEP SOLID COMBUSTIBLES, SUCH AS BUILDING MATERIALS, PAPER OR CARDBOARD, A SAFE DISTANCE AWAY FROM THE HEATER AS RECOMMENDED BY THE INSTRUCTIONS NEVER USE THE HEATER IN SPACES WHICH DO OR MAY CONTAIN VOLATILE OR AIRBORNE COMBUSTIBLES, OR PRODUCTS SUCH AS GASOLINE, SOLVENTS, PAINT THINNER, DUST PARTICLES OR UNKNOWN CHEMICALS.

Scheu Products Company, Incorporated
Mail: P.O. Box 250, Upland, CA 91785
Plant: 8855 Baker Ave., Rancho Cucamonga, CA 91730
Telephone: 800-325-7057
www.scheuco.com
customerservice@scheuco.com

8506
September 2002

Models

SPC-15R/15R SPC-30R/30R

OPERATING PRECAUTIONS

This is a propane, direct-fired, infrared heater. It's intended use is primarily temporary heating of buildings under construction, alteration or repair.

Propane is heavier than air. If propane leaks from a connection or fitting, it sinks to the floor, collecting there with the surrounding air, forming a potentially explosive mixture. Obviously, propane leaks should be avoided, so set up the propane supply with utmost care. Read enclosed Odor Fade and Propane Sheet for additional information about detecting propane leaks. Leak check new connections or reconnections with a soap and water solution and follow all connection instructions herein. Also, ask your propane dealer for advice on the propane application and supply installation and ask him to check it if there are any questions.

Check with your local fire safety authority if you have any questions about your applications. Standards govern the use of fuel gases and heat producing products in specific applications. Your local authority can advise you about these.

Direct-Fired means that all of the combustion products enter the heated space. Even though this heater operates very close to 100 percent combustion efficiency, it still produces small amounts of carbon monoxide. Carbon monoxide (called CO) is toxic. We can tolerate small amounts but not a lot. CO can build up in a heated space and failure to provide adequate ventilation could result in death. The symptoms of inadequate ventilation are:

headache	dizziness
burning eyes and nose	nausea
dry mouth or sore throat	

So, be sure to follow advice about ventilation in these operating instructions.

When the heater is to be operated in the presence of other people the user is responsible for properly acquainting those present with the safety precautions and instructions, and of the hazards involved.

SAFETY PRECAUTIONS

1. Keep children and animals away from heater.
2. Never operate heater while sleeping or unattended.
3. Check the heater thoroughly for damage. DO NOT operate a damaged heater.
4. DO NOT modify the heater or operate a heater which has been modified from its original condition.
5. Use only propane gas.
6. Use only VAPOR WITHDRAWAL propane supply. If there is any question about vapor withdrawal, ask your propane dealer.
7. For outdoor use only. AREA MUST BE WELL VENTILATED. Provide minimum openings of 1 sq ft (.093m²) near the floor and 1 sq ft (.093²) near the ceiling. Do not use inside house, camper, tent and vehicle. Or any type of unvented or enclosed area.
8. Do not use heater in basement or below ground level.
9. Before connecting heater to the propane tank, make sure the heater regulator knob is in the "OFF" position. Always connect and light heater in areas free of open flames.
10. Mount the propane cylinders vertically (shutoff valve up). Secure them from falling or being knocked over and protect them from damage.
11. **IMPORTANT** Use only the hose and regulator assembly provided with the model SPC-30R / 30R. Inspect the hose assembly before each use of the SPC-30R/30R. If there is excessive abrasion or wear, or hose is cut, replace with hose assembly listed on parts list before using heater. The hose and regulator must be protected from damage.
12. The heater burner must be at least 2 ft. (.61m) above the floor. Always attach to propane tank in an upright position. Never operate a heater on its side or attach to propane tank in a horizontal position. This could lead to dangerous flare-ups or fire. Do not direct heat toward propane cylinders.
13. Maintain minimum clearance from normal combustible materials (like paper) as follows: Sides - 3 ft. (.91m); Top & Front - 5 ft. (1.5m). Locate 10 ft. (3m) from canvas or plastic tarpaulins or similar coverings and secure them to prevent flapping or movement due to wind action.
14. If at any time gas odor is detected, IMMEDIATELY DISCONTINUE operation until the source of gas has been located and corrected. Read enclosed Odor fade and Propane Sheet for additional information about detecting propane leaks.
15. Install the heater such that it is not directly exposed to water spray, rain, dripping water and/or wind.
16. Operate only on a stable, level surface.
17. Due to the high surface and exhaust temperatures, adults and children must observe clearances to avoid burns or clothing ignition.
18. Since permanent skin tissue damage can occur, do not move, handle or service while hot or burning. Do not attach or remove a hot or operating heater from the propane tank.
19. Before each use, check heater for leaks. Never use an open flame to check for leaks. Apply a mixture of liquid soap and water to all joints. Bubbles forming show a leak. Correct all leaks.
20. Keep all connections and fittings clean. Make sure propane tank valve is clean. Check "O" ring on heater inlet fuel valve connector for damage before each use. Replace if worn or damaged.
21. Use only in accordance with local codes or, in the absence of local codes, with the Standard for the Storage and Handling of Liquefied Petroleum Gases ANSI/NFPA 58 and CSA B149.1, Natural Gas and Propane Installation Code.

Models

SPC-15R/15R SPC-30R/30R

ODOR FADE WARNING



WARNING

Asphyxiation Hazard

- Do not use this heater for heating human living quarters.
- Do not use in unventilated areas.
- The flow of combustion and ventilation air must not be obstructed.
- Proper ventilation air must be provided to support the combustion air requirements of the heater being used.
- Refer to the specification section of the heater's manual, heater dataplate, or contact the *Scheu Products Company* to determine combustion air ventilation requirements of the heater.
- Lack of proper ventilation air will lead to improper combustion.
- Improper combustion can lead to carbon monoxide poisoning leading to serious injury or death. Symptom of carbon monoxide poisoning can include headaches, dizziness and difficulty in breathing.

FUEL GAS ODOR

LP gas and natural gas have man-made odorants added specifically for detection of fuel gas leaks.

If a gas leak occurs you should be able to smell the fuel gas. Since Propane (LP) is heavier than air you should smell for the gas odor low to the floor. ANY GAS ODOR IS YOUR SIGNAL TO GO INTO IMMEDIATE ACTION!

- Do not take any action that could ignite the fuel gas. Do not operate any electrical switches. Do not pull any power supply or extension cords. Do not light matches or any other source of flame. Do not use your telephone.
- Get everyone out of the building and away from the area immediately.
- Close all propane (LP) gas tank or cylinder fuel supply valves, or the main fuel supply valve located at the meter if you use natural gas.
- Propane (LP) gas is heavier than air and may settle in low areas. When you have reason to suspect a propane leak, keep out of all low areas.
- Use your neighbor's phone and call your fuel gas supplier and your fire department. Do not re-enter the building or area.
- Stay out of the building and away from the area until declared safe by the firefighters and your fuel gas supplier.
- **FINALLY**, let the fuel gas service person and the firefighters check for escaped gas. Have them air out the building and area before you return. Properly trained service people must repair any leaks, check for further leakages, and then relight the appliance for you.

ODOR FADING - NO ODOR DETECTED

- Some people cannot smell well. Some people cannot smell the odor of the man-made chemical added to propane (LP) or natural gas. You must determine if you can smell the odorant in these fuel gases.
- Learn to recognize the odor of propane (LP) gas and natural gas. Local propane (LP) gas dealers will be more than happy to give you a scratch and sniff pamphlet. Use it to become familiar with the fuel gas odor.
- Smoking can decrease your ability to smell. Being around an odor for a period of time can affect your sensitivity to that particular odor. Odors present in animal confinement buildings can mask fuel gas odor.
- **The odorant in propane (LP) gas and natural gas is colorless and the intensity of its odor can fade under some circumstances.**
- If there is an underground leak, the movement of gas through the soil can filter the odorant.
- Propane (LP) gas odor may differ in intensity at different levels. Since Propane (LP) gas is heavier than air, there may be more odor at lower levels.
- **Always be sensitive to the slightest gas odor.** If you continue to detect any gas odor, no matter how small, treat it as a serious leak. Immediately go into action as discussed previously.



ATTENTION - CRITICAL POINTS TO REMEMBER!

- Propane (LP) gas has a distinctive odor. Learn to recognize these odors. (Reference Fuel Gas Odor and Odor Fading sections above.)
- Even If you are not properly trained in the service and repair of the heater, **ALWAYS** be consciously aware of the odors of propane (LP) gas and natural gas.
- If you have not been properly trained in repair and service of propane (LP) gas then do not attempt to light heater, perform service or repairs, or make any adjustments to the heater on the propane (LP) gas fuel system.
- A periodic sniff test around the heater or at the heater's joints; i.e. hose, connections, etc., is a good safety practice under any conditions. If you smell even a small amount of gas, **CONTACT YOUR FUEL GAS SUPPLIER IMMEDIATELY. DO NOT WAIT!**

Models
SPC-15R/15R SPC-30R/30R
MODELS
SPC-30R 30R

ASSEMBLY INSTRUCTIONS

1. Inspect the heater components for possible shipping damage. If any is found, immediately notify the dealer.
2. Follow the following instructions to assemble the SPC-30R /30R:

1.	 <p style="text-align: center;">Figure 1</p>	<p>Check to make sure that all of the following packaged components (see Figure 1) are included.</p> <table style="width: 100%; border: none;"> <tr> <td>Burner Assembly w/ regulator</td> <td style="text-align: right;">1</td> </tr> <tr> <td>Burner Assembly w/o regulator</td> <td style="text-align: right;">1</td> </tr> <tr> <td>Heater Support</td> <td style="text-align: right;">1</td> </tr> <tr> <td>Tank Plate</td> <td style="text-align: right;">1</td> </tr> <tr> <td>Wing Nuts</td> <td style="text-align: right;">2</td> </tr> <tr> <td>Burner Clamp</td> <td style="text-align: right;">2</td> </tr> <tr> <td>Burner Mtg. Screw</td> <td style="text-align: right;">2</td> </tr> <tr> <td>Piezo Ignitor</td> <td style="text-align: right;">1</td> </tr> <tr> <td>Piezo Mtg. Nut</td> <td style="text-align: right;">1</td> </tr> </table>	Burner Assembly w/ regulator	1	Burner Assembly w/o regulator	1	Heater Support	1	Tank Plate	1	Wing Nuts	2	Burner Clamp	2	Burner Mtg. Screw	2	Piezo Ignitor	1	Piezo Mtg. Nut	1
Burner Assembly w/ regulator	1																			
Burner Assembly w/o regulator	1																			
Heater Support	1																			
Tank Plate	1																			
Wing Nuts	2																			
Burner Clamp	2																			
Burner Mtg. Screw	2																			
Piezo Ignitor	1																			
Piezo Mtg. Nut	1																			
2.	 <p style="text-align: center;">Figure 2</p>	<p>Insert the piezo ignitor into the bracket on the burner support as shown in Figure 2. Then tighten the piezo-mounting nut. Care should be taken not to over tighten the nut.</p>																		

Models
SPC-15R/15R SPC-30R/30R

MODELS
SPC-30R 30R

ASSEMBLY INSTRUCTIONS

3.



Figure 3

Connect the burner hoses together as shown in Figure 3 & 4. Wrench tighten to insure leak tight connection.



Figure 4

4.





Figure 5

Mount the burner onto the support using the burner clamps and screws as shown in Figure 5. Care must be taken to insure that the air holes on the sides of the burner tube are not blocked. Securely tighten the burners into place.

Models
SPC-15R/15R SPC-30R/30R
MODELS
SPC-30R 30R

ASSEMBLY INSTRUCTIONS

5.	 <p style="text-align: center;">Figure 6</p>  <p style="text-align: center;">Figure 7</p>	<p>Attach the electrode wires to the piezo Ignitor as shown in Figures 6 & 7.</p>
----	--	---

OPERATING INSTRUCTIONS
MODELS SPC-15R/15R SPC-30R/30R

PREPARING FOR OPERATION

1. Check the heater for possible shipping damage. If any is found, immediately notify the factory.
2. Follow all of the Safety and Operating Precautions.
3. Refer to the exploded view for general assembly layout.
4. Check the "O" ring on the POL before each use. Replace the "O" ring if there is any sign of wear or damage.
5. Make sure heater regulator knob is on the "OFF" position.
6. (A) Attach the heater (30R only) to the guard on the propane cylinder with the body of the stand on the inside of the guard and the bolts through two holes in the guard (see Figure 1). Tighten the latching plate into place using the wing nuts provided (see Figure 2).
6. (B) Connect the POL fitting at regulator (15R/30R) to the propane cylinder by rotating the POL nut counter-clockwise into the propane cylinder's valve outlet and securely tighten with a wrench. **WARNING: Attach heater in upright position. Never attach heater in a horizontal position. This could lead to dangerous flare-ups or fire.**
7. Securely tighten all gas connections.
8. Open the cylinder's gas valve and check all gas connections with a soap and water solution. **DO NOT USE A FLAME.**



Figure 1



Figure 2

Models

SPC-15R/15R SPC-30R/30R

OPERATING INSTRUCTIONS

START

WARNING: When lighting the heater DO NOT look over top of heater (reflector). Stand to the side of the heater during ignition. Do not stand or have any part of your body in front of the heater.

- 1. WARNING: MAKE SURE THERE IS NO OPEN FLAME IN THE AREA.** Fully open the valve on the propane cylinder.
- Turn the heater regulator knob counterclockwise to the "HI" position.
- To light: (Read all lighting instructions before attempting to ignite heater)
 - Repeatedly push and release the piezo electric ignitor (SPC-30R), or place a lighted match near the face of the heating element (mesh screen) of the burner you are lighting, using the hole located on the side of the reflector. **CAUTION: DO NOT LIGHT AT THE ORIFICE.**
 - Depress the red button on the safety valve admitting gas to the burner. **WARNING: DO NOT DEPRESS RED VALVE BUTTON BEFORE REPEATEDLY ACTIVATING THE PIEZO (SPC-30R) OR INSERTING MATCH.**
 - When the gas on the face of the mesh screen lights, continue to hold the valve button depressed for 30 seconds, then release.
- If flame goes out, wait 5 minutes and repeat the lighting procedure.
- If heater will not light after repeated tries, do not attempt to repair heater. Return heater to nearest authorized service center or to manufacturer of this product, freight prepaid.
- (SPC-30R) Repeat steps 1 through 4 to ignite the other burner.
- After both burners (SPC-30R) or single burner (SPC-15R), are lit, turn the heater regulator knob to the desired heat setting (LOW, MED, HI).

STOP

- Securely close valve on the propane cylinder.
- Turn the heater regulator knob to the "OFF" position. Wait 15 minutes for the heater to cool down before handling heater.
- Always remove the heater from the propane tank after each use. Do not store the heater while attached to propane tank. Remove the heater from the propane tank by turning the fuel connector nut clockwise. Always store propane tank outdoors. Never store propane tank in an enclosed area.

RESTART AFTER SAFETY SHUTDOWN

- Securely close valve at propane cylinder.
- Wait 5 minutes.
- Restart following "Start" procedure.

MAINTENANCE AND STORAGE

- The heater should be inspected before each use, and at least annually by a qualified person.
- Before each use, check the soft "O" ring seat at the bullnose of the POL fitting. If the "O" ring is cut, scuffed, or otherwise damaged, replace it with part number 6681.
- Turn off the gas at the LP-gas supply cylinder when the heater is not in use.
- When the heater is to be stored, the connection between the LP-gas supply cylinder and the heater must be disconnected and the cylinder removed from the heater and stored out of doors and in accordance with Chapter 5 of the standard for Storage and Handling of Liquefied Petroleum Gases ANSI/NFPA 58.

SERVICING

A hazardous condition may result if a heater is used that has been modified or is not functioning properly. When the heater is working properly:

- * The flame is contained within the heater.
- * The flame is essentially blue.
- * There is no strong disagreeable odor, eye burning or other physical discomfort.
- * There is no smoke or soot internal or external to the heater.
- * There are no unplanned or unexplained shut downs of the heater.

The parts lists and exploded view show the heater as it was constructed. Do not use a heater which is different from that shown. In this regard, use only the hose, regulator and cylinder connection fitting (called a POL fitting) supplied with the heater.

IMPORTANT For this heater, the regulator must be set as shown in "specifications". If there is any uncertainty about the regulator setting, have it checked.

A heater which is *not* working right must be repaired, but *only* by a trained, experienced service person. To find the service center closest to you, visit our website at www.scheuco.com or call (888) 619-7060.

You may also obtain in-warranty or out-of-warranty service by taking the product to your local service center.

In-warranty products will be repaired with no charge for either parts or labor. Please include a brief statement indicating date, place of purchase, the nature of the problem and proof of purchase.

Out-of-warranty products will be repaired with a charge for parts and labor.

Models

SPC-15R/15R SPC-30R/30R

PARTS BREAKDOWN

SPC-15R/15R

SPC-30R/30R

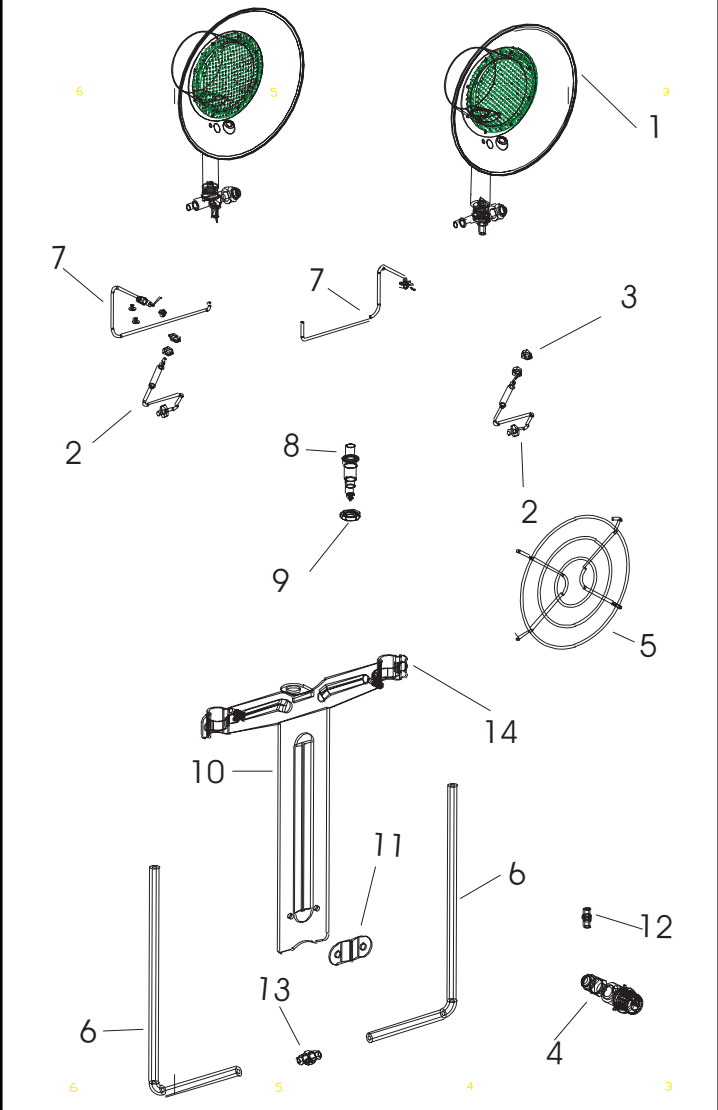
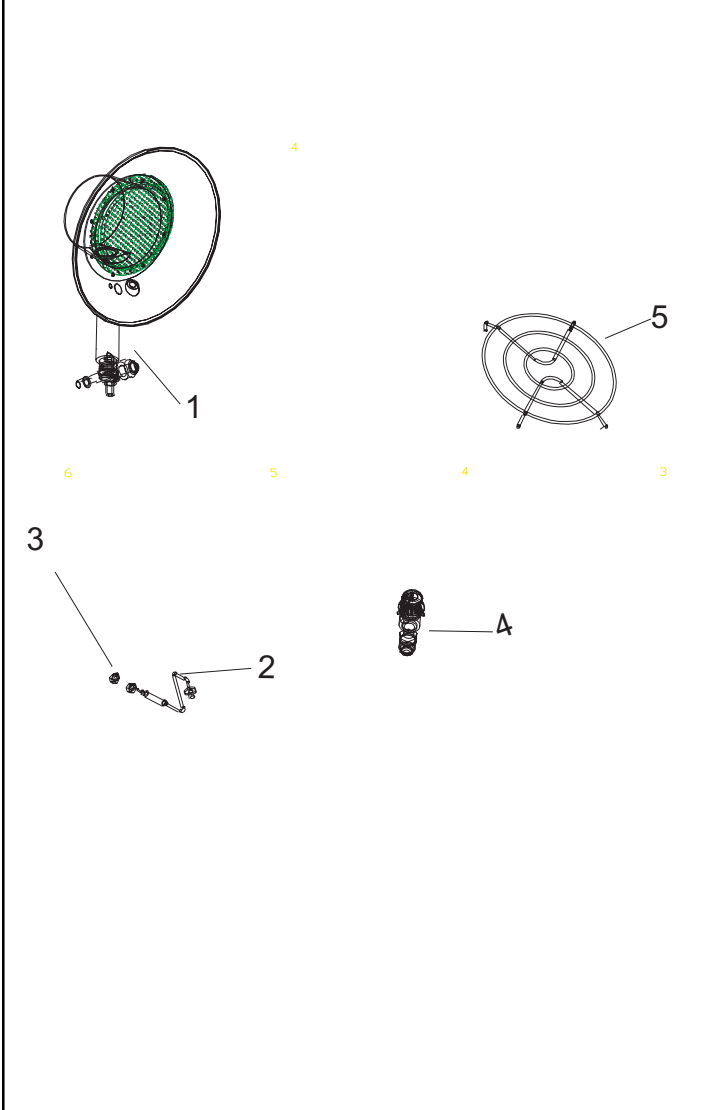

ITEM NO.	PART NUMBER SPC15R	DESCRIPTION	QTY
1.	8660	BURNER HEAD ASSY	1
2.	8661	THERMOCOUPLE	1
3.	8662	NUT, THERMOCOUPLE	2
4.	8663	POL EXCESS FLOW/REGULATOR	1
5.	8664	GRILLE	1
*	8632	INSTRUCTION HANG TAG	1
*	8506	MANUAL	1

*NOT SHOWN

ITEM NO.	PART NUMBER SPC30R	DESCRIPTION	QTY
1.	8660	BURNER HEAD ASSEMBLY	2
2.	8661	THERMOCOUPLE	2
3.	8662	NUT, THERMOCOUPLE	4
4.	8663	POL EXCESS FLOW/REGULATOR	1
5.	8664	GRILLE	2
6.	8665	HOSE ASSEMBLY	2
7.	8666	ELECTRODE ASSEMBLY	2
8.	8672	PIEZO IGNITOR	1
9.	8673	NUT, PIEZO	1
10.	8667	SUPPORT ARM	1
11.	8668	BRACKET, SUPPORT ARM	1
12.	8669	FITTING	1
13.	8670	FITTING	1
14.	8671	BURNER HEAD MOUNTING BRACKET	2
*	8656	INSTRUCTION HANG TAG	1
*	8506	MANUAL	1

* NOT SHOWN

Models

SPC-15R/15R SPC-30R/30R

WARRANTY

We are pleased that you have selected our product and take this opportunity to assure you that qualified service facilities are available if required. With the cooperation of independent dealers, a nationwide network of authorized servicing dealers is available for your servicing requirements.

Should your product require servicing, read the section of the manual entitled "Servicing".

Who gets the warranty? The warranty is limited to the consumer who originally purchases the product.

What is covered? This limited warranty covers all imperfections in workmanship and material.

What is not covered? This limited warranty does not cover damage resulting from accident, misuse or abuse, lack of proper maintenance, affixing of any attachments not provided with the products, or loss of parts. **IN NO EVENT SHALL SCHEU PRODUCTS COMPANY BE LIABLE FOR ANY SPECIAL, INCIDENTAL OR CONSEQUENTIAL DAMAGES NOR FOR ANY DAMAGES RESULTING FROM MISUSE OR MODIFICATION OF THIS PRODUCT.**

Registering this heater within 10 days of date of purchase ensures the buyer the protection as stated on our limited warranty form.

LIMITED WARRANTY

The company warrants this product to be free from imperfections in material or workmanship, under normal and proper use in accordance with instructions of The Company, for a period of one year from the date of delivery to the buyer. The Company, at its option, will repair or replace (f.o.b. factory, California) products returned by the buyer to the factory, California, transportation prepaid within said one year period and found by the Company to have imperfections in material or workmanship.

If a part is damaged or missing, simply e-mail us at php@scheuco.com, visit our website at scheuco.com, or call our Technical Support Department at (888) 619-7060.

Address any Warranty Claims to the Customer Service Department, Scheu Products Company, Incorporated, P.O. Box 250, Upland, California 91785, or e-mail us at php@scheuco.com. Include your name, address and telephone number and include details concerning the claim. Also, supply us with the purchase date and the name and address of the dealer from whom you purchased our product.

The foregoing is the full extent of the responsibility of the Company. There are no other warranties, express or implied. Specifically there is no warranty of fitness for a particular purpose and there is no warranty of merchantability. In no event shall the Company be liable for delay caused by imperfections, for consequential damages, or for any charges of the expense of any nature incurred without its written consent. The cost of repair or replacement shall be the exclusive remedy for any breach of warranty. There is no warranty against infringement of

the like and no implied warranty arising from course of dealing or usage of trade. This warranty will not apply to any product which has been repaired or altered outside of the California factory in any respect which in our judgment affects its condition or operation.

Some states do not allow the exclusion or limitation of incidental or consequential damages, so the above limitation or exclusion may not apply to you. This Warranty gives you specific legal rights, and you may have other rights which vary from state to state.

SERVICE CENTERS

Scheu Products Company has over 1,000 service centers throughout North America. Call (888) 619-7060 or email php@scheuco.com to request the service center nearest you. Include the Make and model of your heater in any emails.

INSTRUCTIONS FOR ORDERING PARTS

We recommend that only parts supplied by the manufacturer be used on this unit. A locally purchased part may appear to be identical, although in reality it might endanger the heater or the persons operating the heater.

The heater should be serviced only by a trained, experienced service person.

Read the section on "Servicing" before ordering parts.

For parts orders, call 888-619-7060 or e-mail us at php@scheuco.com. Please have the model number of your heater and the replacement part number when placing your order.

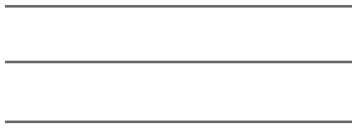

SCHEU PRODUCTS COMPANY, INC
ATTN: MARKETING DEPARTMENT
8855 BAKER AVENUE
RANCHO CUCAMONGA, CA 91730

Visit our website for product information, technical support, customer service, and warranty registration at:
WWW.ALLPRO-HEATERS.COM for All-Pro products or WWW.UNVERISAL-HEATERS.COM for Universal products.

Free Manuals Download Website

<http://myh66.com>

<http://usermanuals.us>

<http://www.somanuals.com>

<http://www.4manuals.cc>

<http://www.manual-lib.com>

<http://www.404manual.com>

<http://www.luxmanual.com>

<http://aubethermostatmanual.com>

Golf course search by state

<http://golfingnear.com>

Email search by domain

<http://emailbydomain.com>

Auto manuals search

<http://auto.somanuals.com>

TV manuals search

<http://tv.somanuals.com>