

# Use and Care Guide

## Refrigerator—Freezer



<b>English Version</b> .....	2
<b>Version française</b> .....	19
<b>Versión en español</b> .....	39



<b>Safety Instructions</b> .....	2, 3
----------------------------------	------



### Operating Instructions, Tips

Automatic Icemaker & Dispenser .....	4–6
Freezer Compartment .....	8
Freezer Baskets .....	8
Loading the Freezer Compartment .....	8
Shelves .....	7
Porta-Bins .....	7
Quick Space Shelf .....	7
Slide-Out Spillproof Shelves .....	7
Wine Rack .....	7
Storage Drawers .....	6
Temperature Controls .....	3



### Care and Cleaning

Behind the Refrigerator.....	9
Cleaning—Inside and Outside.....	8
Drawer and Cover Removal.....	9
Light Bulb Replacement .....	9
Under the Refrigerator.....	9



<b>Problem Solver</b> .....	16–18
Normal Operating Sounds.....	16



### Preparation

Adding Door Panels .....	11, 12
Clearances .....	10
Location.....	10
Moving and Vacation.....	10
Rollers/Leveling .....	10
Water Supply to Icemaker .....	10



### Installation

Earthing.....	12, 13
Electrical Requirements.....	12, 13
Fitting a Different Plug.....	13
Great Britain and Ireland .....	13
How to Install Features.....	14
Additional Features .....	15
Mains Lead Replacement .....	3, 13



Model and Serial Numbers .....	2
--------------------------------	---

*Side by Side 21 Built-In,  
Export G-Line*



## HELP US HELP YOU...

### Read this guide carefully.

It is intended to help you operate and maintain your new refrigerator properly.

Keep it handy for answers to your questions.

### Write down the model and serial numbers.

You'll see them on a label on the wall beside the top drawer or at the bottom, inside the fresh food compartment door.

Please write these numbers here:

Model Number

Serial Number

Use these numbers in any correspondence or service calls concerning your refrigerator.

### If you received a damaged refrigerator...

Immediately contact the dealer (or builder) that sold you the refrigerator.

### Save time and money. Before you request service...

Check the Problem Solver in the back of this guide. It lists minor operating problems that you can correct yourself.

### Products are continuously being improved...

Therefore product features and specifications may change or vary slightly.



## IMPORTANT SAFETY INSTRUCTIONS

Read all instructions before using this appliance.



**WARNING**—When using this appliance, always exercise basic safety precautions, including the following:

- Use this appliance only for its intended purpose as described in this Use and Care Guide.



- This refrigerator must be properly installed and located in accordance with the Installation Instructions before it is used.



**WARNING**—Connect to potable water supply only.

- Never unplug your refrigerator by pulling on the power cord. Always grip plug firmly and pull straight out from the outlet.
- Repair or replace immediately all electric service cords that have become frayed or otherwise damaged. Do not use a cord that shows cracks or abrasion damage along its length or at either the plug or appliance end.
- When moving your appliance away from the wall, be careful not to roll over or damage the power cord.
- Do not allow children to climb, stand or hang on the shelves in the refrigerator. They could damage the refrigerator and seriously injure themselves.



- If your old refrigerator is still around the house but not in use, be sure to remove the doors. This will reduce the possibility of danger to children.

- After your refrigerator is in operation, do not touch the cold surfaces in the freezer compartment, particularly when hands are damp or wet. Skin may adhere to these extremely cold surfaces.
- Do not place fingers or hands on the automatic ice-making mechanism while the refrigerator is plugged in. This will prevent contact with the moving parts of the ejector mechanism, or with the heating element that releases the cubes.
- Don't refreeze frozen foods which have thawed completely. Food safety experts say:

“...You may safely refreeze frozen foods that have thawed if they still contain ice crystals or if they are still cold—below 4°C.

“...Thawed ground meats, poultry or fish that have any off-odor or off-color should not be refrozen and should not be eaten. Thawed ice cream should be discarded. If the odor or color of any food is poor or questionable, get rid of it. The food may be dangerous to eat.

“...Even partial thawing and refreezing reduces the eating quality of foods, particularly fruits, vegetables and prepared foods. The eating quality of red meat is affected less than that of many other foods. Use refrozen foods as soon as possible to save as much of their eating quality as you can.”



- **Unplug your refrigerator before cleaning and making repairs.** **NOTE:** We strongly recommend that any servicing be performed by a qualified individual.
- Before replacing a burned-out light bulb, unplug the refrigerator or turn off power at the circuit breaker or fuse box in order to avoid contact with a live wire filament. (A burned-out light bulb may break when being replaced.) **NOTE:** Turning control to “O” position does not remove power to the light circuit.
- **Do not store or use gasoline or other flammable vapors and liquids in the vicinity of this or any other appliance.**

### Mains lead replacement

If the mains lead on your refrigerator needs replacing at any time, it must be replaced by a special lead which is obtainable from your local dealer. A charge will be made for the replacement of the mains lead if you have damaged the lead.

## SAVE THESE INSTRUCTIONS



## OPERATING YOUR REFRIGERATOR

### Set the Temperature Controls (appearance may vary)

Two controls let you regulate the temperature in the fresh food and freezer compartments.

At first, set both the fresh food control and the freezer control to “5.”

Allow 24 hours for the temperature to stabilize, whether you are setting the controls for the first time or adjusting them later. Then, if you want colder or warmer temperatures in either compartment, adjust the controls one step at a time.

**NOTE:** Moving the freezer control to the “O” position turns off cooling in both compartments—fresh food and freezer—but does not shut off power to the refrigerator.

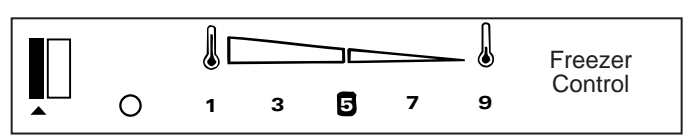
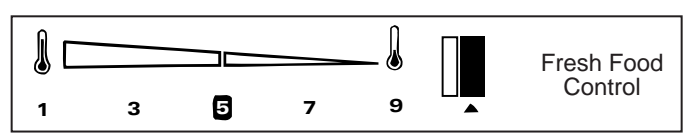

### Ambient Room Temperature Limits

This refrigerator is designed to operate in ambient temperatures specified by its Temperature Class which is marked on the rating plate.

Temperature Class	Symbol	Ambient Temperature	
		Maximum	Minimum
Extended-Temperate	SN	32°C	10°C
Temperate	N	32°C	16°C
Subtropical	ST	38°C	18°C
Tropical	T	43°C	18°C

**NOTE:** Internal temperature may be affected by such factors as the location of the refrigerator, ambient temperature and frequency of door openings. Adjust temperature controls as required to compensate for these factors.

### How to Test Temperatures

**Use the milk test for the fresh food compartment.** Place a container of milk on the top shelf in the fresh food compartment. Check it a day later. If the milk is too warm or too cold, adjust the temperature controls.

**Use the ice cream test for the freezer compartment.** Place a container of ice cream in the center of the freezer compartment. Check it after a day. If it's too hard or too soft, adjust the temperature controls.

**Always allow 24 hours for the refrigerator to reach the temperature you set.**

### Automatic Energy-Saver System

You won't find an “energy-saver” switch on this refrigerator.

Warm liquid from the refrigerator's condenser is automatically circulated around the front edge of the freezer compartment to help keep moisture from forming on the outside of the refrigerator during humid weather.

### No Defrosting

It is not necessary to defrost the freezer or fresh food compartments. Although your refrigerator is designed and equipped to defrost itself automatically, some frost on packages is normal.



# AUTOMATIC ICEMAKER & DISPENSER

(on some models)

## How It Works

The automatic icemaker makes ice continually. The dispenser dispenses water, ice cubes or crushed ice through the freezer compartment door. Here's how they work.

### Water flows from the household supply through a

- (1) dual solenoid valve to the
- (2) water tubing and to the
- (3) automatic icemaker as needed.

### Water is frozen in the

- (4) cube mold and ejected into the
- (5) storage bin where a motor-powered auger moves cubes forward.

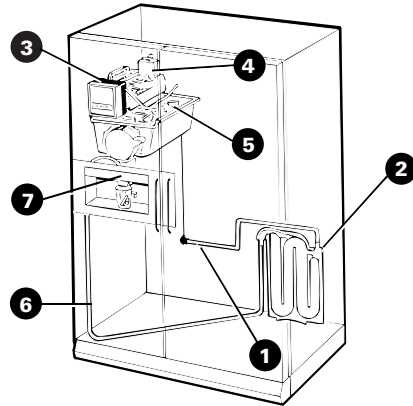

Cubes dispense through the chute in the door when the dispenser pad is pressed.



When the Crushed pad is pressed (on some models), a baffle channels cubes through the crusher and crushed ice falls through a chute into the glass.



When the Water pad is selected (on some models), water flows through the

(6) tubing in the door and is dispensed when the dispenser pad is pressed.

(7) A light switch (on some models) turns the night light in the dispenser on or off.

The light also comes on when the dispenser pad is pressed.

The light in the dispenser should be replaced with a 10 watt maximum bulb when it burns out.

If you cannot locate the correct bulb, see your local dealer.

## Important Facts About Your Ice & Water Dispenser

• **If this is your first icemaker you'll hear occasional sounds that may be unfamiliar.** These are normal ice-making sounds and are not cause for concern.

• **Your icemaker will produce eight cubes per cycle—**approximately 120 cubes in a 24-hour period—depending on freezer compartment temperature, room temperature, number of door openings and other use conditions.

• **Intermittent dispensing of ice is normal.** If ice flow interruption is more than brief, ice clump(s) may be the cause and should be removed following instructions in this section.

• **Avoid over-filling glasses with ice and using narrow or extra-tall glasses.** This can jam the chute or cause the door in the chute to freeze shut. Periodically open the freezer compartment door and look down into the chute. If ice is blocking the chute, poke it through with a wooden spoon.

• **To help keep bits of ice from being sprayed beyond the glass,** place the glass close to the ice chute—but not so close that it blocks out-coming ice.

• **Add ice before adding beverage to prevent splashing.**

• **Beverages and foods should not be quick-chilled in the ice storage bin.** Cans, bottles or food packages in the storage bin may cause the icemaker or auger to jam.

• **Do not add ice from trays or bags to the storage bin.** It may not crush or dispense well.

**CAUTION:** Some products such as water ices should not be consumed too cold.

## Before Using Your Icemaker and Dispenser

If you use your refrigerator before the water connection is made, raise the ice access door and make sure the icemaker feeler arm is in the **○** (up) position. When the water supply has been connected to the icemaker, move the feeler arm to the **I** (down) position.

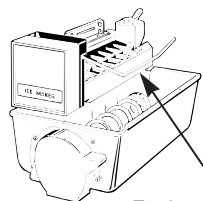
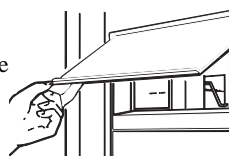

Feeler arm in **○** (up) position stops icemaking

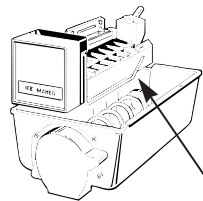

Feeler arm in **I** (down) position begins icemaking

At first there will be a delay before water is dispensed and ice is made.

On models with a water dispenser, if no water is dispensed when the refrigerator is first installed, there may be air in the water line system. Press the dispenser pad for at least two minutes to remove trapped air from the water line and to fill the water system.



Push the dispenser pad until the water line is filled.

The ice cube mold will automatically fill with water AFTER cooling to freezer temperatures. The first cubes normally freeze after several hours.

**NOTE:** With a newly-installed refrigerator, allow about 24 hours for the freezer compartment to get cold enough to make ice.

(continued next page)



## Once Your Icemaker and Dispenser are in Operation

Throw away the first few batches of ice cubes (16 or 24 cubes). This will flush away any impurities in the water line. Do the same thing after vacations or extended periods when ice isn't used.

On models with a water dispenser, pour the first six glassfuls of water in the kitchen sink. The first water through the system picks up a slight "plastic" taste from the water tubing.

**To make sure the bin fills with ice, level the cubes occasionally.** When cubes fall into the bin they may pile up close to the icemaker and push the feeler arm to the **O** (up) position, which stops icemaking, before the bin gets full. Keeping the cubes level allows the icemaker to fill the bin.

## To Dispense Ice and Water

• Select:



water (on some models),



ice cubes,



or crushed ice (on some models).

Dispenser pad



• Grip the glass or other container near the rim and press the rim against the center of the dispenser pad.

Dispenser pad

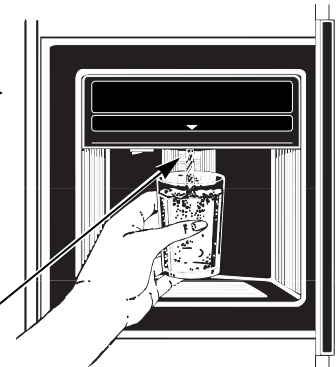

## When Dispensing Ice...

**Some crushed ice may be dispensed even though you selected Cubes.** This happens occasionally when a few cubes get channeled to the crusher.

**Sometimes a mound of snow will form on the door in the ice chute.** This condition is normal, and usually occurs when you have dispensed crushed ice repeatedly. The snow will eventually evaporate.

Sometimes crushed ice will spray beyond the glass. To avoid this, hold the glass up close to the chute.

**CAUTION: Never put fingers or other objects into the dispenser opening.**

## When Dispensing Water...

**The first glass of water dispensed may be warmer than the following ones.** This is normal.

**Dispensed water is cool, not iced.** For colder water, simply add crushed ice or cubes before dispensing water.

## To Stop Dispensing

Release pressure from the dispenser pad and wait a few seconds to catch the last bits of ice or drops of water.

There may be some dripping after dispensing crushed ice or water. If there is a lot of dripping, the spill should be wiped dry right away.



Press here to remove grille



Do not pour water in the spill shelf because it is not self draining—pour it in the kitchen sink. The shelf and its grille should be cleaned regularly according to Care and Cleaning instructions. The grille is easily removed by pressing on the back right corner.

## If Ice Clumps Form in the Storage Bin...

The icemaker ejects cubes in groups of eight, and it is normal for several cubes to be joined together. However, if you don't use the ice very often ice clumps may form in the storage bin and can clog the dispenser.

**If this happens:**

- Remove the storage bin from the freezer.
- Break up ice clumps with your hands. Throw away any clumps that you can't break up.
- Replace the bin before the remaining cubes melt and fuse together.

(continued next page)



# AUTOMATIC ICEMAKER & DISPENSER

(continued)

## To Remove Ice Storage Bin

Lift the left corner to free the bin from the shelf. Pull the bin straight out while supporting it at front and back.

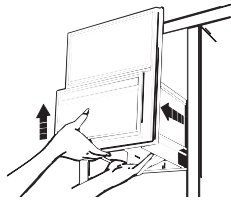

## To Replace Ice Storage Bin

Slide the bin back until the tab on the bin locks into the slot in the shelf.

If the bin does not go all the way back, remove it and turn the drive mechanism 1/4 turn. Then push the bin back again until the tab on the bin locks into the slot in the shelf.

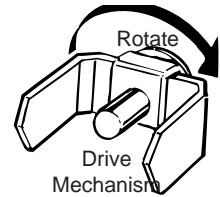

## If Ice is Not Used Often...

“Old” ice cubes will become cloudy and taste stale. Empty ice storage bin periodically and wash it in lukewarm water. Be sure to allow storage bin to cool before replacing it—otherwise ice cubes will stick to the metal auger.

## Move the icemaker feeler arm to the O (up) position when...

- Home water supply is to be turned off for several hours.
- Ice storage bin is to be removed for a period of time.
- Going away on vacation, at which time you should also turn off the valve in the water supply line to your refrigerator.
- Moving the freezer control to “O” position.

# STORAGE DRAWERS

## Fruit & Vegetable Drawers

The top 2 storage drawers at the bottom of the fresh food compartment are designed to provide high humidity levels required by most vegetables and lower humidity levels required for most fruits.

When replacing the drawers, always push them all the way in.

Storage time will depend upon the type of food and its condition when placed in the drawers.

Excess water that may accumulate in the bottom of the drawers should be emptied and the drawers wiped dry.

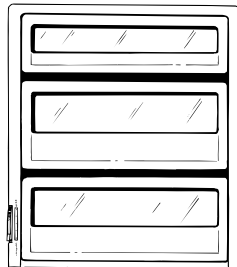

## Adjustable Humidity Drawers



These drawers have individual, adjustable humidity controls that let you regulate the amount of moisture retained in foods.

Slide the control all the way to the setting and the drawer provides **high humidity** recommended for most vegetables.

Slide the control all the way to the setting to provide **lower humidity** levels recommended for most fruits.

## High Humidity

Setting the drawer for high humidity keeps unwrapped foods fresh by retaining the natural moisture content of foods such as:

- Artichokes
- Corn
- Rhubarb
- Carrots
- Parsley
- Cherries
- Radishes
- Blueberries
- Lettuce
- Peas, green
- Plums
- Beets, topped
- Greens, leafy
- Tomatoes, ripe
- Asparagus
- Currants
- Spinach
- Celery

As in any refrigerated storage area, it is recommended that foods with strong odors be stored wrapped—foods such as:

- Broccoli
- Cauliflower
- Cabbage
- Turnips
- Parsnips
- Green onions
- Brussels sprouts

The high humidity setting also works well for the convenient storage of lunch meats and cheese, hors d'oeuvres, spreads and snacks.

## Low Humidity

Setting the drawer for low humidity keeps the following foods fresh:

- Apples
- Peaches
- Mushrooms
- Oranges
- Grapes
- Raspberries
- Squash, summer
- Pears
- Tangerines
- Apricots
- Strawberries
- Nectarines

## Convertible Drawer

The Convertible drawer has its own cold air duct to allow a stream of cold air from the freezer compartment to flow around the drawer.

The **variable temperature control** regulates the air flow from the freezer compartment.

Set control lever down to the coldest setting to store fresh meats. If lever is left in meat position for a long period of time, some frost may form on the inside of the drawer.

Set control lever up to convert the drawer to normal refrigerator temperature and provide extra vegetable storage space. Cold air duct is turned off. Variable settings between these extremes can be selected.

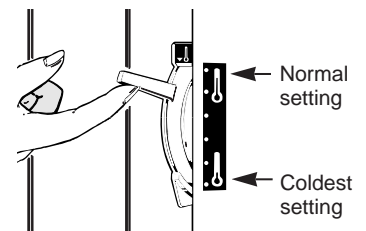

# SHELVES



## Quick Space Shelf (on some models)

This shelf splits in half and slides under itself for storage of tall items on the shelf below.

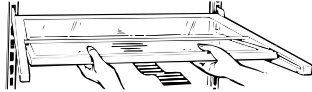

## Slide-Out Spillproof Shelves (on some models)

The slide-out shelf allows you to reach items stored behind others. The special edges are designed to help prevent spills from dripping to lower shelves. Make sure you push them all the way back in before you close the door.

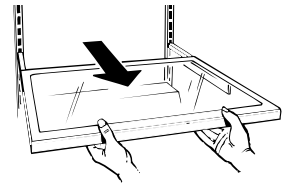

## How to Rearrange Your Shelves

The shelves in the fresh food compartment are adjustable, enabling you to make efficient shelf arrangements to fit your family's food storage needs.

### To remove shelves:

Tilt the shelf up at front, then lift it up and out of the tracks on the rear wall of the refrigerator.

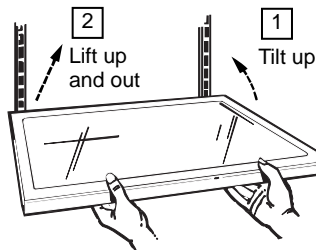

### To relocate shelves:

Select desired shelf height. With shelf front raised slightly, engage the top hooks in the tracks at the rear of the cabinet. Then lower the front of the shelf until it locks into position.

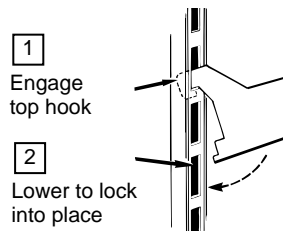

## Bins on Fresh Food Compartment Door

(on some models)

Adjustable bins can easily be carried from the refrigerator to your work area.

### To remove:

Lift bin straight up until mounting hooks disengage.

### To replace or relocate:

Select desired shelf height, engage bin's hook in slots on the tracks of the door, and push in. Bin will lock in place.

The divider (on some models), helps prevent tipping, spilling or sliding of small items stored on the door shelf.

Place index finger and middle finger on either side of the divider near the front and simply move it back and forth to fit your needs.

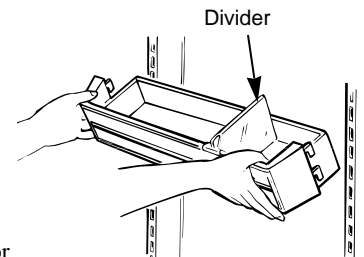

## Removable Wine Rack (on some models)

The wine rack is designed to hold a bottle on its side and will fit on any shelf.

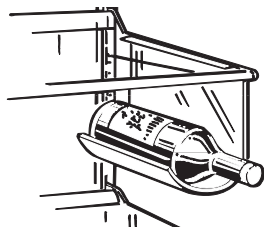

### To relocate the wine rack:

Pull wine rack straight out. Then position its lip over either edge of the shelf you want to suspend it from and push it all the way in.

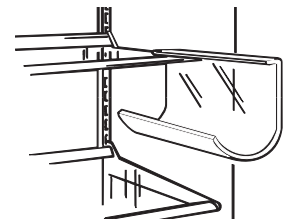



## FREEZER COMPARTMENT

### Loading the Freezer Compartment

Load so that at least 15 mm of space remains clear between stacks of packages and 15 mm to 25 mm of space between the top of any stack and any shelf or basket above it. Packages may hang over the front of shelves but must remain 15 mm from doors.

- Food to be frozen must not be placed in direct contact with food in storage. If food is to be frozen every day, it may be necessary to reduce the quantity to be frozen.
- Food is most quickly frozen on the middle three shelves of the freezer compartment and most slowly in the freezer door shelves.
- Do not store commercially quick-frozen food longer than the time recommended by the food manufacturers.
- The freezer door storage shelves marked with a two-star label are only appropriate for the storage of previously frozen food.

**Effervescent drinks should not be stored in the freezer compartment.**

### Freezer Baskets (on some models)

Wire slide-out freezer baskets can be pulled out for easy access to frozen foods.

**WARNING:** Poor performance may occur if freezer baskets are not used. Storage of items in the freezer without using baskets may result in poor temperature performance due to restrictions of air flow within the freezer compartment.

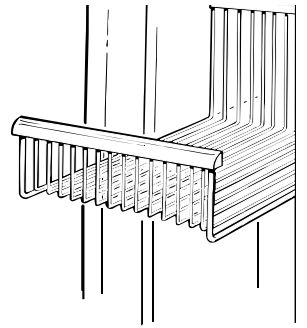

## CARE AND CLEANING

### Cleaning—Outside

**The water and ice dispenser spill shelf** should be wiped dry immediately to prevent spotting. Water left on the shelf may leave deposits that you can remove by soaking in undiluted vinegar.

You can also use a paste of non-precipitating water softener and water, or 5 ml of citric acid powder per 500 ml of hot tap water. Soak until the deposit disappears or becomes loose enough to rinse away.

Usually 30 minutes soaking time is adequate. Avoid using wax on the spill shelf and trim.

**The dispenser pad** can be cleaned by using a warm water and baking soda solution—about 15 ml of baking soda to one liter of water. Rinse thoroughly with water and wipe dry.

**The door handles** can be cleaned with a cloth dampened with a solution of mild liquid dishwashing detergent and water. Dry with a soft cloth. Don't use wax on the door handles with metal trim.

**Keep the finish clean.** Wipe with a clean cloth lightly dampened with kitchen appliance wax or mild liquid dishwashing detergent. Dry and polish with a clean, soft cloth. Do not wipe the refrigerator with a soiled dishwashing cloth or wet towel. These may leave a residue that can erode the paint. Do not use scouring pads, powdered cleaners, bleach or cleaners containing bleach because these products can scratch and weaken the paint finish.

**Protect the paint finish.** The outside of the refrigerator has a high quality, baked-on paint finish. With proper care, it will stay new-looking and rust-free for years. Apply kitchen/appliance wax when the refrigerator is new and then at least twice a year.

**The long door handles and trim** (on models with trim kit) can be cleaned with a cloth dampened with a solution of mild liquid dishwashing detergent and water. Dry with a soft cloth. Don't use wax on the door handles and trim.

### Cleaning—Inside

**Inside the fresh food and freezer compartments** should be cleaned at least once a year. Unplug the refrigerator before cleaning. If this is not practical, wring excess moisture out of sponge or cloth when cleaning around switches, lights or controls.

Use warm water and baking soda solution—about 15 ml of baking soda to one liter of water. This both cleans and neutralizes odor. Rinse thoroughly with water and wipe dry.

**Other parts of the refrigerator**—including door gaskets, meat and vegetable drawers, ice storage bin and all plastic parts—can be cleaned the same way. After cleaning door gaskets, apply a thin layer of petroleum jelly to the door gaskets at the hinge side. This helps keep the gaskets from sticking and bending out of shape. If the freezer baskets don't slide freely after cleaning, lubricate them with petroleum jelly. Do not use cleansing powders or other abrasive cleaners.

To help prevent odors, leave an open box of baking soda in the rear of the refrigerator, on the top shelf. Change the box every three months. An open box of baking soda in the freezer will absorb stale freezer odors.

Avoid cleaning cold glass shelves with hot water because the extreme temperature difference may cause them to break.

**Do not wash any plastic parts from your refrigerator in your automatic dishwasher.**

**Drain opening in the freezer compartment.** During yearly cleaning, remove bottom freezer basket and flush a baking soda solution—5 ml of baking soda and 500 ml of hot (not boiling) water—through the drain line with the help of a meat baster. This will help eliminate odor and reduce the likelihood of a clogged drain line.

If drain becomes clogged, use a meat baster and baking-soda-and-water solution to force the clog through the drain line.





## Drawer and Cover Removal

Drawers will stop before coming all the way out of the refrigerator to help prevent contents from spilling onto the floor. Drawers can easily be removed by tilting up slightly and pulling past the “stop” location.

To remove the glass shelf above the top drawer, first remove the top drawer and any food on the shelf. Then, reach in, push the rear of the glass up until it touches the bottom of the lower light shield. Then push the shelf back (approx. 13 mm) until it clears both the front corner retainers.

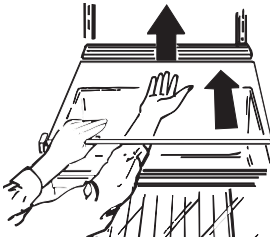

To replace the glass shelf, reverse the steps.

When replacing the drawers, make sure you slide them through both drawer guides on the right side.

Then press down on the top of the shelf to make sure the shelf sits firmly on top of both drawer guides.

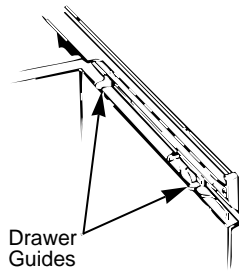

To remove the drawers when the fresh food compartment door cannot be opened fully, remove the lower bins on the fresh food door.

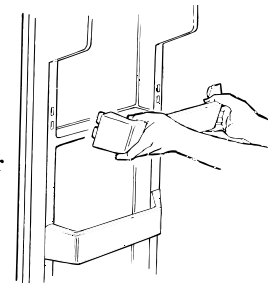

To remove bins, first remove the food in the bins. Then, grasping the bin at each end, push in at the bottom as you lift and pull out at the top. Once the bins are removed the drawers will come straight out.

## Under Refrigerator

For most efficient operation, you need to keep the area under the refrigerator clean. Turn the temperature control to “O.” Remove the base grille. Sweep away or vacuum dust that is readily accessible on the condenser coils, then turn the control back on.

For best results, use a brush specially designed for this purpose, available at most appliance parts stores. This easy cleaning operation should be done at least once a year.

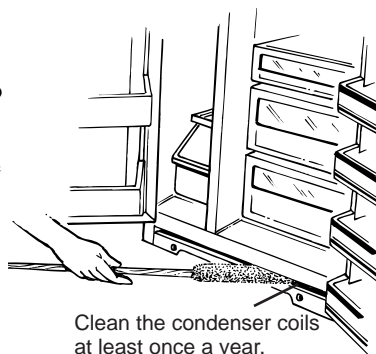

## Behind Refrigerator

Care should be taken in moving your refrigerator away from the wall. All types of floor coverings can be damaged, particularly cushioned coverings and those with embossed surfaces. Pull the refrigerator straight out and return it to position by pushing it straight in. Moving the refrigerator in a side direction may result in damage to the floor covering or refrigerator.

When pushing the refrigerator back, make sure you don't roll over the power cord or icemaker supply line (on some models).

## Light Bulb Replacement

### Fresh Food Compartment—Upper Light

1. Unplug refrigerator.
2. Remove the snap-in light shield.

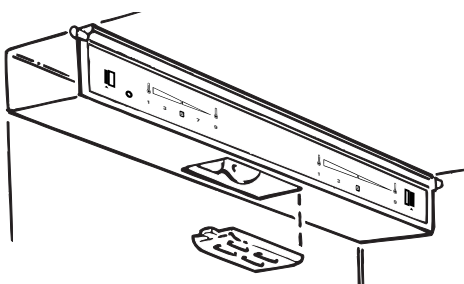

3. Replace with same size bulb and reinstall the light shield. If you cannot locate the correct bulb, see your dealer.

### Fresh Food Compartment—Lower Light (on some models)

This light is located behind a shield at the rear of the fresh food compartment.

1. Unplug the refrigerator.
2. Grasp the top edge of the shield and lift it up and forward to free its top edge.
3. After replacing with the same size bulb, hook the top of the shield back in place. If you cannot locate the correct bulb, see your dealer.
4. Plug the refrigerator back in.

### Freezer Compartment with a Dispenser

1. Unplug the refrigerator.
  2. Remove the shelf just below the light shield. (The shelf will be easier to remove if it is emptied first.)
  3. Pull the light shield toward you to reach the bulb.
- After replacing with same size bulb, reinstall shelf and plug the refrigerator back in.



# PREPARATION

## Clearances

Allow the following clearances for ease of installation, proper air circulation and plumbing and electrical connections:

- Sides .....3 mm
- Top .....25 mm  
(If built-in, allow 22 mm for hinge covers.)
- Back .....13 mm

If the refrigerator is against a wall on either side, allow 19 mm for door clearance.

## Refrigerator Location

Do not install it on a floor strong enough to support a fully loaded refrigerator.

## When You Go on Vacation

**For extended vacations or absences**, shut off the power to the refrigerator, move the freezer control to the "O" position, and clean the interior with a baking soda solution of 15 ml of baking soda to one liter of water. Wipe dry. To prevent odors, leave an open box of baking soda in the refrigerator. Leave doors open.

**Move icemaker feeler arm to O (up) position, which stops icemaking, and be sure to shut off water supply to the refrigerator.**

**For shorter vacations**, remove perishable foods and leave controls at regular settings. However, if room temperature is expected to drop below 16°C, follow the same instructions as for extended vacations.

## When You Move

Disconnect power cord from wall outlet, remove all food, and clean and dry the interior.

**Secure all loose items** such as grille, shelves and storage pans by taping them securely in place to prevent damage.

Be sure refrigerator stays in upright position during actual moving and in van. Refrigerator must be secured in van to prevent movement. Protect outside of refrigerator with blanket.

## Rollers

Adjustable rollers behind the base grille enable you to move the refrigerator away from the wall for cleaning. These rollers should be set so that the refrigerator rests firmly on the floor. Side-by-side refrigerators also have specially designed door hinges that lift both doors slightly when opened, allowing the force of gravity to help close them securely.

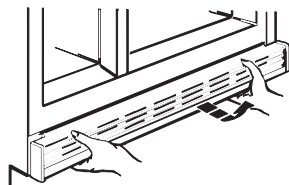

## Leveling

**To adjust rollers**, remove the base grille by grasping it at the bottom and pulling it out.

**Turn front roller adjusting screws** clockwise to raise the refrigerator, counterclockwise to lower it. Use an adjustable wrench (3/8" hex head bolt) or pliers.

Turn the rear roller adjusting screws clockwise to raise the refrigerator, counterclockwise to lower it. Use a flat blade screwdriver.

**NOTE:** When leveling, you can improve door closure by raising the front as much as 15 mm more than the rear of the refrigerator.

**To replace base grille**, align prongs on back of grille with clamps in cabinet and push forward until grille snaps into place.

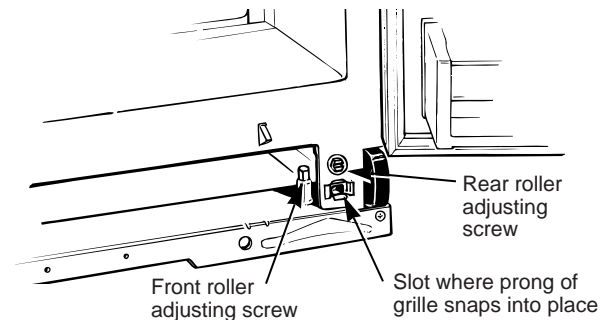

## Water Supply to Icemaker (on some models)

If your refrigerator has an icemaker, or if you plan to add an icemaker later, the icemaker will have to be connected to a cold drinking (potable) water line.

A water supply kit containing copper tubing, shutoff valve, fittings and instructions is available at extra cost from your dealer. There should be sufficient tubing from the cold water supply to the icemaker inlet to allow moving the refrigerator out from the wall several feet (approximately 2.5 m of 1/4" copper tubing in three 25 cm diameter coils).

Do not use kits with plastic tubing since there is water pressure in the supply line at all times.

Maximum permissible inlet water pressure—8.3 bars.

Minimum permissible inlet water pressure—1.4 bars.

Installation of icemaker must be made by a qualified service technician.



## Adding Door Panels (on models with trim kit)

These instructions describe how to insert decorator panels and what size the panels should be.

Panels should be cut to the following dimensions:

Top freezer panel—36.4 cm x 47.6 cm

Bottom freezer panel—36.4 cm x 82.2 cm

Fresh food panel—51.0 cm x 165.6 cm

Panels that are 6 mm thick will fit the door frame trim with no special preparation. If you have a material thinner than 6 mm, you will need to add a filler behind the panel for proper fit.

Pre-cut white and black panels are available from your dealer.

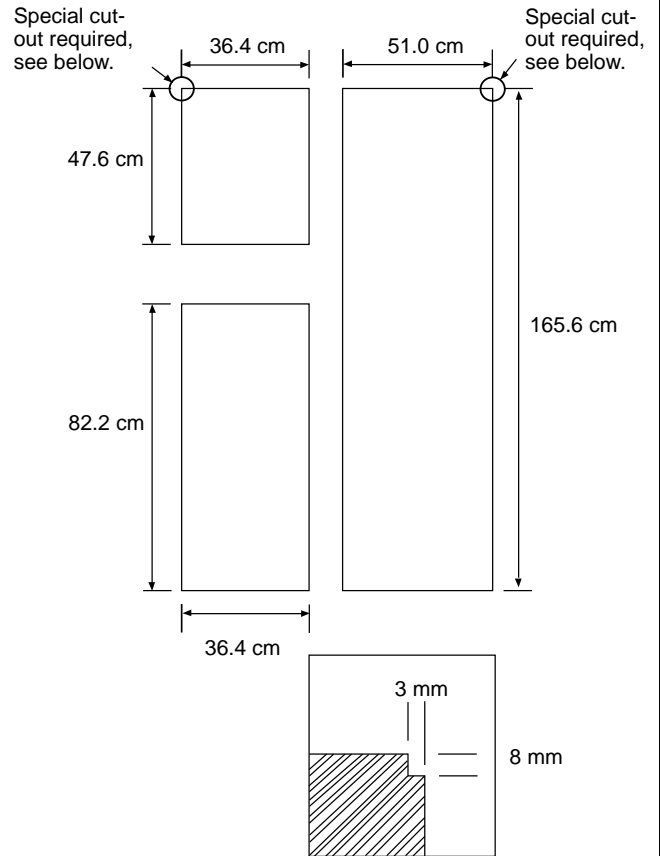

A cut-out is required at these outer corners, 8 mm long, 3 mm deep.

## Inserting the Door Panels

### 1. REMOVE THE DOOR HANDLE TRIM

- Open the freezer door and remove the single screw from the top handle cap. **Do not try to remove the cap.**
- Loosen the screws across the top trim of the door approximately 6 mm. This allows the top handle cap to slip out from under the top trim.
- Remove the 5 screws from the full-length handle. Keep all screws. *Extra replacement screws for the door trim can be found in the storage drawers.*
- Carefully** remove the freezer door handle along with the top handle cap.

**NOTE:** Be careful not to damage the bottom handle cap when removing the freezer door handle. It is attached to the full-length handle with a screw and does not need to be removed from the handle.

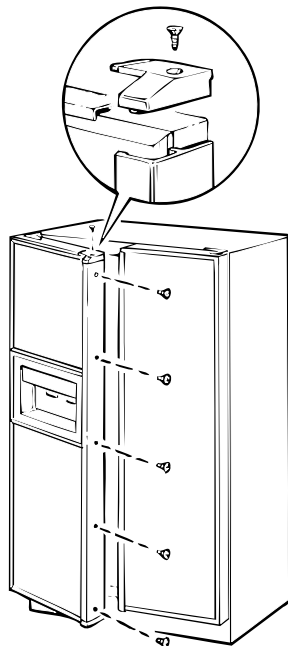

### 2. INSERT THE PANELS

Carefully push the door panels into the slots. Make sure that the top freezer panel is put in with the cut-out at the upper left hand corner. When inserting the fresh food panel make sure the cut-out is at the upper right hand corner.

### 3. REPLACE THE DOOR HANDLE TRIM

Reinstall the full-length handle and top handle cap. Loosely screw the handle onto the door. Place the cap on the top of the handle and loosely screw down the cap. Lift the handle up and tighten the top screw on the handle. Then tighten the handle cap screw so that the cap and handle fit flush. Tighten all the screws.

The fresh food panel is installed the same way.

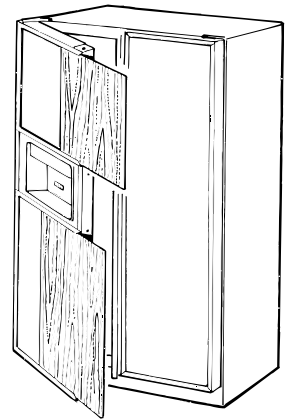

(continued next page)



## PREPARATION

(continued)

### 19 mm or Raised Panel

A raised panel design screwed or glued to a 6 mm thick backing, or a 19 mm routed board can be used. The raised portion of the panel must be fabricated to permit clearances of at least 51 mm from the handle side for fingertip clearance and 32 mm from the hinge side to avoid striking adjacent cabinetry.

**Weight limitations for custom panels:**  
Fresh Food : 17 kg max.  
Freezer Door : 9 kg max.

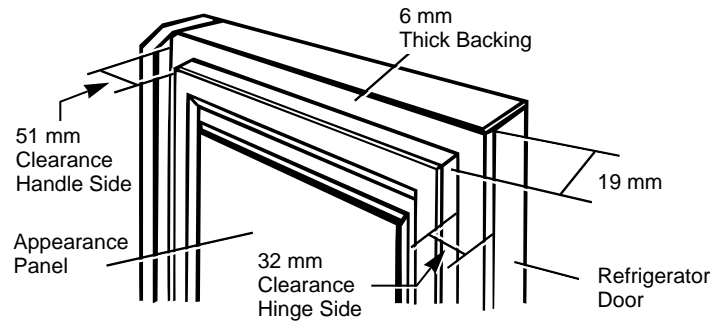

## INSTALLATION REQUIREMENTS

**IMPORTANT...Please read carefully**

### Electrical Requirements

**The refrigerator should always be plugged into its own individual electrical outlet**—Please refer to the rating plate on the refrigerator for the correct voltage and frequency. This is recommended for best performance and to prevent overloading house wiring circuits, which could cause a fire hazard from overheated wires.

**WARNING: HOW TO AVOID ACCIDENTS TO CHILDREN. WHEN DISCARDING AN OLD REFRIGERATOR OR FREEZER BE CERTAIN TO MAKE THE LOCK UNUSABLE. IF POSSIBLE, REMOVE THE DOORS AND DISCARD SEPARATELY. DO NOT ATTEMPT TO STAND ON TOP OF YOUR APPLIANCE. IT IS NOT DESIGNED FOR SUCH USE AND YOU COULD INJURE YOURSELF OR DAMAGE THE APPLIANCE BY SUCH ABUSE. CHILDREN SHOULD NOT BE ALLOWED TO PLAY WITH THE APPLIANCE OR TAMPER WITH THE CONTROLS.**

### How to Connect Electricity

#### For personal safety, this appliance must be properly earthed.

The power cord of this appliance is equipped with an earthing plug which mates with a standard grounding wall outlet to minimize the possibility of electric shock hazard from appliance.

Have the wall outlet checked by a qualified electrician to make sure the outlet is properly earthed.



Where an unearthed wall outlet is encountered, it is your personal responsibility and obligation to have it replaced with a properly earthed wall outlet.

If the power supply cord becomes damaged, it must be replaced by a qualified service agent in order to avoid a safety hazard.

If the plug does not fit your outlet a new plug can be fitted. **IMPORTANT:** In some countries the refitting of electric plugs and cables is only permitted when the work is completed by a qualified technician.

# INSTALLATION INSTRUCTIONS

FOR GREAT BRITAIN AND IRELAND ONLY

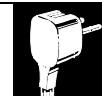

## Electrical Requirements

We recommend that this appliance is connected to the mains supply via a suitable switched socket in a readily accessible position. All appliances come complete with a fitted plug. The plug on your Food Centre has a 13A fuse. If the plug does not fit your sockets, a new plug can be fitted. Cut off the old plug and throw it away, do not insert it into a socket elsewhere in the house as this could cause a shock.

**WARNING: THIS APPLIANCE MUST BE EARTHED.**

## Mains Lead Replacement

If the mains lead on this appliance needs replacing at any time, it must be replaced by a special lead which is obtainable from your nearest Service centre. A charge will be made for the replacement of the mains lead if you have damaged the lead.

## IMPORTANT: Fitting a Different Plug

The wires in the mains lead are coloured in accordance with the following code: Green and Yellow-Earth; Blue-Neutral; Brown-Live. If you fit your own plug the colours of these wires may not correspond with the identifying marks on the plug terminals. This is what you have to do:

1. Connect the green and yellow (Earth) wire to the terminal in the plug marked 'E' with the symbol or coloured green or green and yellow.
2. Connect the blue (Neutral) wire to the terminal in the plug marked 'N' or coloured black.
3. Connect the brown (Live) wire to the terminal marked 'L' or coloured red.

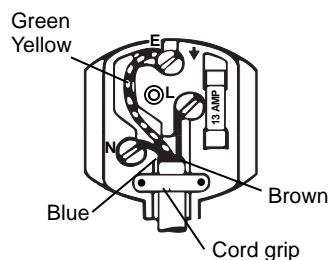

If the plug is the moulded-on type the fuse cover must be refitted when changing the fuse. In the event of losing the fuse cover the plug must not be used until a replacement fuse cover has been obtained and fitted. A new fuse cover can be obtained from your nearest Service Centre or local Electricity Board. The colour of the correct replacement fuse cover is that of the coloured marks or insert in the base of the plug.

In the event of replacing a fuse in the plug supplied with this refrigerator a 13A ASTA approved fuse to BS1362 must be fitted.

With an alternative plug a 15A fuse must be fitted either in the plug or adapter or the main fuse box.



## HOW TO INSTALL FEATURES

**NOT ALL FEATURES ARE ON ALL MODELS.  
(REFER TO THE CONTENTS LIST ON THE BOX.)**

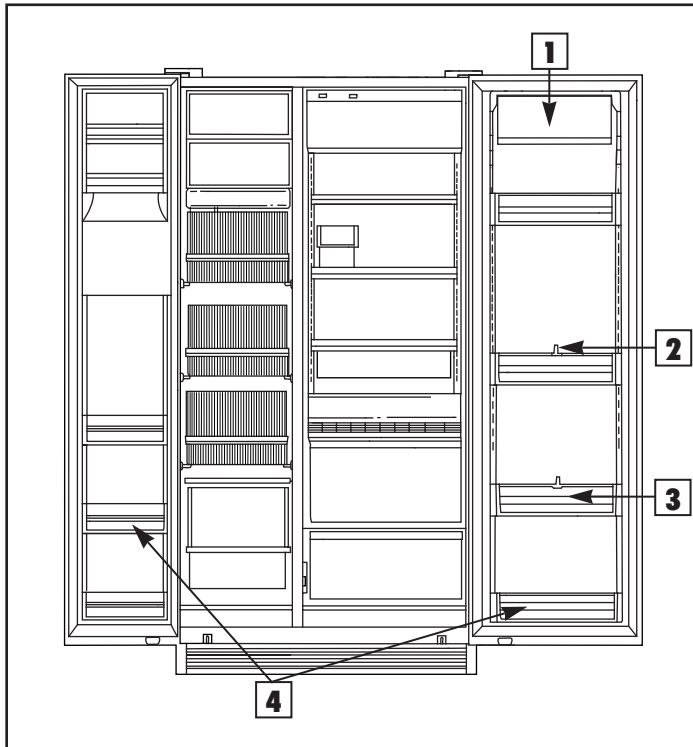

### 3 ADJUSTABLE DOOR BINS

Hook bins into holes in the ladder support at desired locations.

**CAUTION:** Do not place a door bin where door shelf fronts should be.

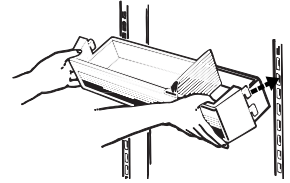

### 4 DOOR SHELF FRONTS

Hook shelf fronts at locations where there are shelves in the door. Make sure they are locked securely into place.

**NOTE:** Shelf fronts must be used in the lowest ladder position on the refrigerator door.

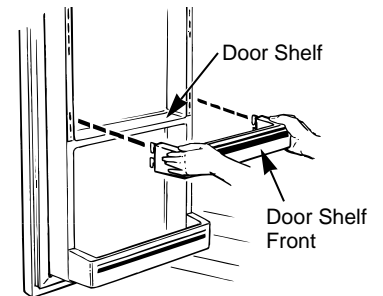

### 1 DAIRY COVER

Depress pins on the cover and insert into holes in the door.

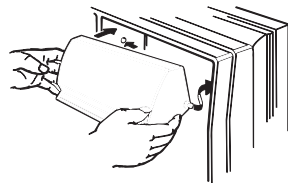

### 2 DOOR BIN SNUGGERS

Roll the snugger on the door bin lip. Slide to the desired location.

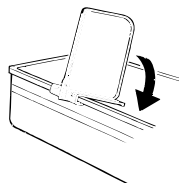

# ADDITIONAL FEATURES

(Available on some models)



**NOT ALL FEATURES ARE ON ALL MODELS.  
(REFER TO THE CONTENTS LIST ON THE BOX.)**

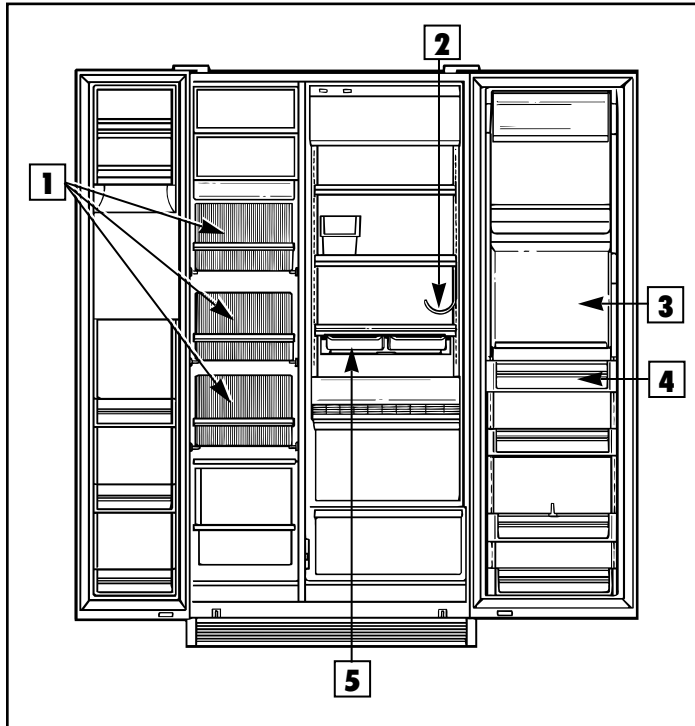

## 1 FREEZER BASKETS

Place the rear edges of the basket on open section of supports. Push in until the basket stops. Tilt up and push all the way in. Make sure the baskets are securely engaged in the supports.

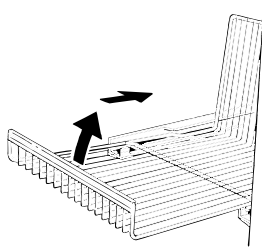

## 2 BEVERAGE RACK

Slide lip of the rack along the edge of the shelf.

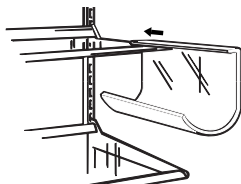

## 3 REFRESHMENT CENTER, INSIDE COVER

Depress pins on cover and insert into holes in sides of the Refreshment Center compartment.

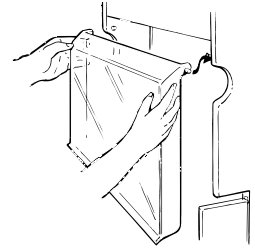

## 4 REFRESHMENT CENTER, DOOR BIN

Hook Refreshment Center bin (with lip) into uppermost slots in shelf tracks.

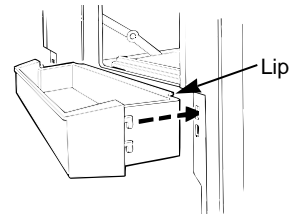

## 5 QUICK SERVE DISHES UNDER SHELF

Slide dishes in the dish rack.

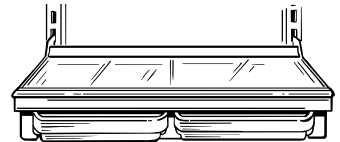



# QUESTIONS? USE THIS PROBLEM SOLVER

PROBLEM	POSSIBLE CAUSE
REFRIGERATOR DOES NOT OPERATE	<ul style="list-style-type: none"> <li>• May be in defrost cycle when motor does not operate for about 30 minutes.</li> <li>• Temperature control is in “○” position.</li> <li>• If interior light is not on, refrigerator may not be plugged in at wall outlet.</li> <li>• If plug is secure and the refrigerator still fails to operate, plug a lamp or a small appliance into the same outlet to determine if there is a tripped circuit breaker or burned-out fuse.</li> </ul>
MOTOR OPERATES FOR LONG PERIODS	<ul style="list-style-type: none"> <li>• Modern refrigerators with more storage space and a larger freezer compartment require more operating time.</li> <li>• Normal when refrigerator is first delivered to your home—usually requires 24 hours to completely cool down.</li> <li>• Large amounts of food placed in refrigerator to be cooled or frozen.</li> <li>• Hot weather—frequent door openings.</li> <li>• Door left open.</li> <li>• Temperature control is set too cold. Refer to Temperature Controls section.</li> <li>• Grille and condenser need cleaning. Refer to Care and Cleaning section.</li> </ul>
MOTOR STARTS AND STOPS FREQUENTLY	<ul style="list-style-type: none"> <li>• Temperature control starts and stops motor to maintain even temperatures.</li> </ul>
VIBRATION OR RATTLING	<ul style="list-style-type: none"> <li>• If refrigerator vibrates, more than likely it is not resting solidly on the floor. The front leveling legs need adjusting, or floor is weak or uneven. Refer to Rollers in Preparation section.</li> <li>• If dishes vibrate on shelves, try moving them. Slight vibration is normal.</li> </ul>

## NORMAL OPERATING SOUNDS

**These sounds are normal and do not indicate a need for service.**

The new high efficiency compressor runs faster and will have a higher pitch hum or pulsating sound while operating.

Defrost timer and refrigerator control click on and off.

The fan circulating air inside the freezer which keeps the temperatures throughout.

Water dropping on the defrost heater causing a sizzling, hissing or popping sound during the defrost cycle.

The flow of refrigerant through the freezer cooling coils sounds like boiling water or a gurgling noise.

Cracking or popping of cooling coils caused by expansion and contraction during defrost and refrigeration following defrost.

Water dripping as it melts from the evaporator and flows to the drain pan during the defrost cycle.

### Icemaker (on some models):

The icemaker water valve will buzz when the icemaker fills with water. If the feeler arm is in the **I** (down) position it will buzz even if it has not yet been hooked up to water. Keeping the feeler arm in the **I** (down) position before it is hooked up to water can damage the icemaker. To prevent this, raise the feeler arm to the **O** (up) position. This will stop the buzzing.

The sound of cubes dropping into the bin and water running in pipes as icemaker refills.

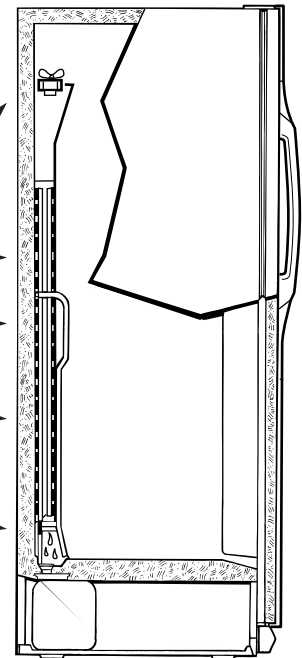





<b>PROBLEM</b>	<b>POSSIBLE CAUSE</b>
FOODS DRY OUT	<ul style="list-style-type: none"><li>• Foods not covered, wrapped or sealed properly.</li></ul>
FRESH FOOD OR FREEZER COMPARTMENT TEMPERATURE TOO WARM	<ul style="list-style-type: none"><li>• Temperature control not set cold enough. Refer to Temperature Control section.</li><li>• Warm weather—frequent door openings.</li><li>• Door left open for too long a time.</li><li>• Package holding door open or blocking air duct in freezer compartment.</li></ul>
FROST OR ICE CRYSTALS ON FROZEN FOOD	<ul style="list-style-type: none"><li>• Door may have been left ajar or package holding door open.</li><li>• Too frequent or too long door openings.</li><li>• Frost within package is normal.</li></ul>
MOISTURE FORMS ON CABINET SURFACE BETWEEN THE DOORS	<ul style="list-style-type: none"><li>• Not unusual during periods of high humidity. To help prevent rust, wipe surface dry.</li></ul>
MOISTURE COLLECTS INSIDE	<ul style="list-style-type: none"><li>• Too frequent or too long door openings.</li><li>• In humid weather, air carries moisture into refrigerator when doors are opened.</li></ul>
REFRIGERATOR HAS ODOR	<ul style="list-style-type: none"><li>• Foods with strong odors should be tightly covered.</li><li>• Check for spoiled food.</li><li>• Interior needs cleaning. Refer to Care and Cleaning section.</li><li>• Defrost water drainage system needs cleaning.</li><li>• Keep open box of baking soda in refrigerator; replace every three months.</li></ul>
HOT AIR FROM BOTTOM OF REFRIGERATOR	<ul style="list-style-type: none"><li>• Normal air flow cooling motor. In the refrigerator process, it is normal that heat be expelled in the area under the refrigerator. Some floor coverings will discolor at these normal and safe operating temperatures. Your floor covering supplier should be consulted if you object to this discoloration.</li></ul>
DIVIDER BETWEEN COMPARTMENTS FEELS WARM	<ul style="list-style-type: none"><li>• Normal warmth is created by automatic energy saver system circulating warm liquid around front edge of freezer compartment to help prevent condensation on outside of refrigerator in hot, humid weather.</li></ul>
DOOR NOT CLOSING PROPERLY	<ul style="list-style-type: none"><li>• Door gasket on hinge side sticking or folding over. To correct, put a small amount of petroleum jelly on the face of the gasket.</li></ul>
INTERIOR LIGHT DOES NOT WORK	<ul style="list-style-type: none"><li>• No power at outlet.</li><li>• Light bulb needs replacing. See the Care and Cleaning section.</li></ul>

(continued next page)



## PROBLEM SOLVER

(continued)

PROBLEM	POSSIBLE CAUSE
AUTOMATIC ICEMAKER DOES NOT WORK (on some models)	<ul style="list-style-type: none"><li>• Icemaker feeler arm in ○ (up) position.</li><li>• Water supply turned off or not connected.</li><li>• Freezer compartment too warm.</li><li>• Cubes too small—water shutoff valve connecting refrigerator to home water line may be clogged.</li><li>• Piled up cubes in storage bin may cause icemaker to shut off prematurely. With icemaker feeler arm in ○ (up) position, level cubes in bin by hand.</li></ul>
CUBE DISPENSER DOES NOT WORK (on some models)	<ul style="list-style-type: none"><li>• No ice cubes. Remove storage bin. If cubes are frozen to wire arm, remove cubes.</li><li>• No ice cubes. Icemaker turned off or water supply turned off.</li><li>• Irregular ice clumps in storage container. Break up as many as you can with fingertip pressure and discard the remaining clumps.</li></ul>
ICE CUBES HAVE ODOR/TASTE (on some models)	<ul style="list-style-type: none"><li>• Old cubes need to be discarded.</li><li>• Ice storage bin needs to be emptied or washed.</li><li>• Unsealed packages in refrigerator and/or freezer compartments may be transmitting odor/taste to ice cubes.</li><li>• Interior of refrigerator needs cleaning. See the Care and Cleaning section.</li><li>• Poor-tasting incoming water. Install a water filter.</li></ul>
CUBES TOO SMALL (on some models)	<ul style="list-style-type: none"><li>• Water shutoff valve connecting refrigerator to home water line may be clogged.</li></ul>
SLOW ICE CUBE FREEZING (on some models)	<ul style="list-style-type: none"><li>• Door may have been left ajar.</li><li>• Turn temperature control to colder setting.</li></ul>
WATER DISPENSER DOES NOT WORK (on some models)	<ul style="list-style-type: none"><li>• Water supply line turned off or not connected.</li><li>• Supply line may be clogged with sediment.</li><li>• If no water is dispensed when the refrigerator is first installed, there may be air in the water system. Press the dispenser pad for at least two minutes to remove trapped air from the water line and to fill the water system.</li></ul>
WATER IN FIRST GLASS IS WARM (on some models)	<ul style="list-style-type: none"><li>• Allow about 24 hours for water to cool to proper temperature after refrigerator is first installed.</li><li>• If water dispenser has not been used for extended period, water in first glass will not be as cool as in succeeding glasses.</li><li>• If the water system has been drained, allow several hours for replenished supply to chill.</li></ul>
WATER HAS POOR TASTE/ODOR (on some models)	<ul style="list-style-type: none"><li>• If the water dispenser has not been used for an extended period, dispense water in regular manner until all water in the system is replenished with fresh water.</li><li>• Poor-tasting incoming water. Install a water filter.</li></ul>
WATER ON FLOOR OR ON BOTTOM OF FREEZER (on some models)	<ul style="list-style-type: none"><li>• The drain at the bottom of the freezer may be clogged. Remove any ice on the freezer bottom and clean the drain.</li><li>• If you use a glass over 15 cm tall, you may be jamming the cubes in the funnel chute. They can fuse inside the chute and drop out later, leaving water or ice on the floor.</li></ul>

## Free Manuals Download Website

<http://myh66.com>

<http://usermanuals.us>

<http://www.somanuals.com>

<http://www.4manuals.cc>

<http://www.manual-lib.com>

<http://www.404manual.com>

<http://www.luxmanual.com>

<http://aubethermostatmanual.com>

Golf course search by state

<http://golfingnear.com>

Email search by domain

<http://emailbydomain.com>

Auto manuals search

<http://auto.somanuals.com>

TV manuals search

<http://tv.somanuals.com>