

17/19-INCH PREMIUM TFT-LCD MONITOR

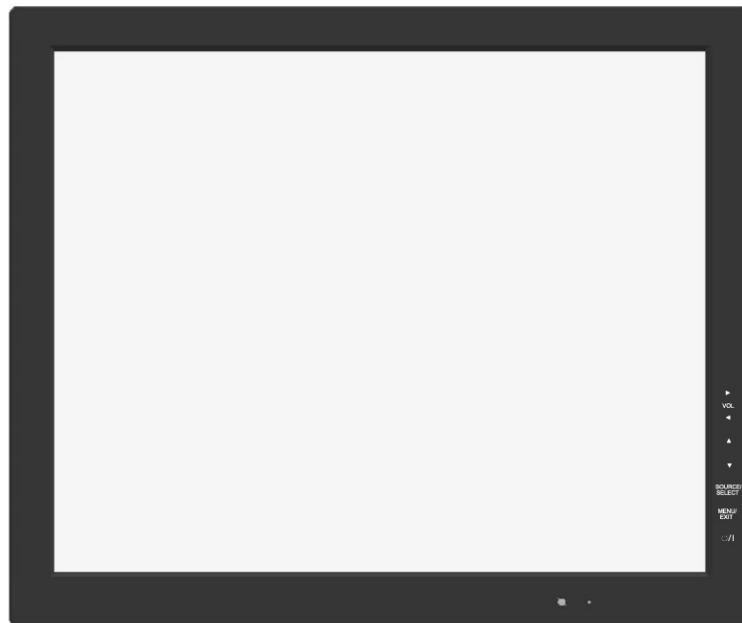

17RTC / 19RTC

INSTRUCTION MANUAL



TOA ELECTRONICS, INC.

601 Gateway Boulevard, Suite 300
South San Francisco, California 94080
Telephone (650) 588-2538 Fax (650) 588-3349
<http://www.toaelectronics.com>

Please read this manual thoroughly before use, and keep it handy for future reference.

CONTENTS

SAFETY INSTRUCTION.....	2 - 3
CAUTIONS	4
FCC RF INTERFERENCE STATEMENT	5
CONNECTING WITH EXTERNAL EQUIPMENT.....	6
REMOTE FUNCTIONS	7
CONTROLS AND FUNCTIONS.....	8 - 26
MOUNTING GUIDE	27
D-SUB CONNECTOR PIN ASSIGNMENTS	28
POWER MANAGEMENT.....	29
SPECIFICATIONS.....	30
TROUBLESHOOTING GUIDE.....	31

This Monitor was
Manufactured by ISO 9001
Certified Factory

SAFETY INSTRUCTION

1. Read all of these instructions.
2. Save these instructions for later use.
3. Follow all warnings and instructions marked on the product.
4. Unplug this product from the wall outlet before cleaning.
Do not use liquid cleaners or aerosol cleaners. Use a damp cloth for cleaning.
5. Do not use this product near water.
6. Do not place this product on an unstable cart, stand or table.
The product may fall, causing serious damage to the product.
7. Slots and openings in the cabinet and the back are provided for ventilation: to ensure reliable operation of the product, these openings must not be blocked by placing the product on a bed, sofa, rug or other similar surface.
This product should never be placed near or over a heat register.
This product should not be placed in a built-in installation unless proper ventilation is provided.
8. This product should be operated from the type of power source indicated on the marking label. If you are not sure of the type of power available, consult your dealer or local power company.
9. This product is equipped with a 3 wire grounding type plug having a third(grounding) pin. This is a safety feature. If you are unable to insert the plug into the outlet, contact your electrician to replace your obsolete outlet. Do not defeat the purpose of the grounding-type plug.
10. Do not allow anything to rest on the power cord.
Do not locate this product where persons will walk on the cord.
11. If an extension cord is used with this product, make sure that the total of the ampere ratings on the products plugged into the extension cord do not exceed the extension cord ampere rating. Also, make sure that the total of all products plugged into the wall outlet does not exceed 10 amperes.
12. Never push objects of any kind into this product through cabinet slots as they may touch dangerous voltage points or short out parts that could result in a risk of fire or electric shock.
Never spill any kind of liquid on the product.
13. Do not attempt to service this product yourself, as opening or removing covers may expose you to dangerous voltage points or other risks.

SAFETY INSTRUCTION

Refer all servicing to service personnel.

14. Unplug this product from the wall outlet and refer servicing to qualified service personnel under the following conditions.
- A. When the power cord or plug is damaged or frayed.
 - B. If liquid has been spilled into the product.
 - C. If the product has been exposed to rain or water.
 - D. If the Product does not operate normally when the operating instructions are followed. Adjust only those controls that are covered by the operating instructions since improper adjustment of other controls may result in damage and will often require extensive work by a qualified technician to restore normal operation.
 - E. If the product has been dropped or the cabinet has been damaged.
 - F. If the product exhibits a distinct change in performance, indicating a need for service.

CAUTION

The power supply cord is used as the main disconnect device, ensure that the socket-outlet is located/installed near the equipment and is easily accessible.

ATTENTION

Le cordon d'alimentation est utilisé comme interrupteur général. La prise de courant doit être située ou installée à proximité du matériel et être facile d'accès

CAUTION TO SERVICE PERSONNEL

POWER SUPPLY CORD IS USED AS MAIN POWER DISCONNECT DEVICE IN THIS PRODUCT. UNPLUG THIS PRODUCT FROM THE WALL OUTLET BEFORE REMOVING THE BACK COVER AND SERVICING

EMISSION CHARACTERISTICS TESTED BY SEMKO

THIS PRODUCT HAS BEEN TESTED AND HAS SHOWN COMPLIANCE WITH THE NATIONAL SPECIFICATIONS SUCH AS SWEDISH MPR 1990.10.(MPR II)

CAUTIONS

▶ **NEVER REMOVE THE BACK COVER**

Removal of the back cover should be carried out only by qualified personnel.

▶ **DO NOT USE IN HOSTILE ENVIRONMENTS**

To prevent shock or fire hazard, do not expose the unit to rain or moisture.

This unit is designed to be used in the office or home. Do not subject the unit to vibrations, dust or corrosive gases.

▶ **KEEP IN A WELL VENTILATED PLACE**

Ventilation holes are provided on the cabinet to prevent the temperature from rising.

Do not cover the unit or place anything on the top of unit.

▶ **AVOID HEAT**

Avoid placing the unit in direct sunshine or near a heating appliance.

▶ **TO ELIMINATE EYE FATIGUE**

Do not use the unit against a bright background and where sunlight or other light sources will shine directly on the monitor.

▶ **BE CAREFUL OF HEAVY OBJECT**

Neither the monitor itself nor any other heavy object should rest on the power cord.

Damage to a power cord can cause fire or electrical shock.

FCC RF INTERFERENCE STATEMENT

NOTE

This equipment has been tested and found to comply with the limits for a Class B digital device, pursuant to Part 15 of the FCC Rules. These limits are designed to provide reasonable protection against harmful interference in a residential installation.

This equipment generates, uses and can radiate radio frequency energy and, if not installed and used in accordance with the instructions, may cause harmful interference to radio communications. However, there is no guarantee that interference will not occur in a particular installation.

If this equipment does cause harmful interference to radio or television reception which can be determined by turning the equipment off and on, the user is encouraged to try to correct the interference by one or more of the following measures.

- Reorient or relocate the receiving antenna.
- Increase the separation between the equipment and receiver.
- Connect the equipment into an outlet on a circuit different from that to which the receiver is connected.
- Consult the dealer or an experienced radio, TV technician for help.
- Only shielded interface cable should be used.

Finally, any changes or modifications to the equipment by the user not expressly approved by the grantee or manufacturer could void the users authority to operate such equipment.

► DOC COMPLIANCE NOTICE

This digital apparatus does not exceed the Class B limits for radio noise emissions from digital apparatus set out in the radio interference regulation of Canadian Department of communications.

CONNECTING WITH EXTERNAL EQUIPMENT

A. BOTTOM PANEL CONTROL

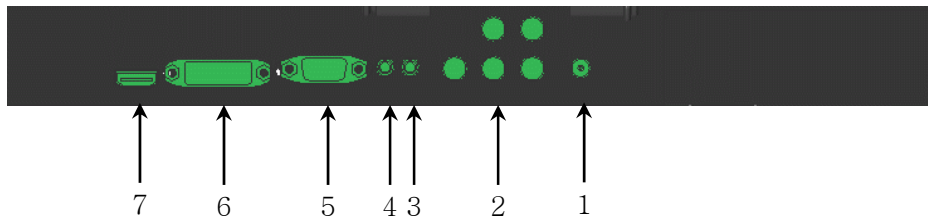

1. DC 12V IN
2. COMPONENT Y,Pb,Pr & SOUND L,R IN
3. AUDIO OUT
4. PC STEREO IN
5. D-SUB IN
6. DVI IN
7. HDMI IN (OPTION)

B. SIDE PANEL CONTROL

1. VIDEO 1(AV1) IN
2. VIDEO 1(AV1) OUT
3. VIDEO 2(AV2) IN
4. VIDEO 2(AV2) OUT
5. S-VIDEO (Y/C) IN
6. S-VIDEO (Y/C) OUT
7. AV1, S-VIDEO AUDIO IN
8. AV1, S-VIDEO AUDIO OUT
9. AV2 AUDIO IN
10. AV2 AUDIO OUT
11. DC12V ADAPTOR

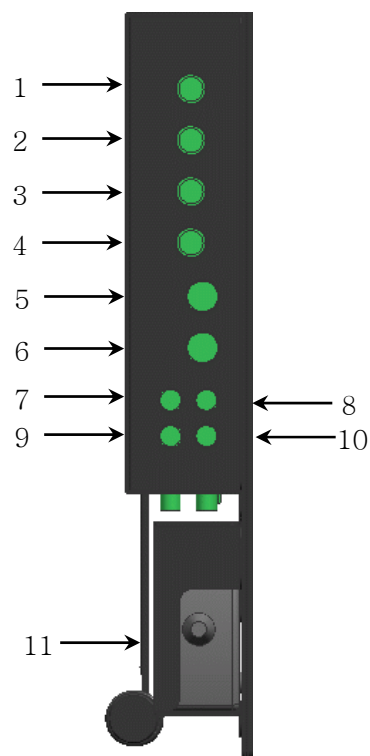

REMOTE FUNCTIONS

C. REMOTE CONTROLLER

1. POWER()

Turns the power ON or OFF. There will be a few seconds delay before the display appears.

2. SOURCE

Select pc or video(AV1 / AV2 / S-Video / PC) sources.

9. AUTO

Auto geometry adjustment in PC Source.

10. MUTE

Mute the sound.

11. MENU

Activates and exits the On Screen Display.

12. EXIT

Exit the On Screen Display.

13. VOL()

Increases or decreases the level of audio volume.

14. UP/DOWN

Move to OSD menu.

15. ENTER

Accepts your selection or displays the current mode.

16. INFO

Input mode information Display.

17. STILL

Pause the picture.

12. PIP (Picture In Picture)

Activates PIP mode.

15. P.INPUT

Select PC or video source.

16. P.POS

Move the position of sub picture for PIP mode.

16. P.SIZE

Change the size of sub and main picture for PIP mode.

14. SWAP

Alternates between main and sub picture.

11. ARC (Aspect Ratio Control)

Select screen ratio.

3. APC (Auto Picture Control)

Select picture mode.

4. ACC (Auto Color Control)

Select Colour mode.

6. S.SET

Select Sound mode main input or sub input

6. PC

Select PC mode(PC,DVI)

5. AV

Select AV mode.(AV1,AV2,S-VIDEO)

7. COMP

Select COMPONENT mode.

7 INSTRUCTION MANUAL



CONTROLS AND FUNCTIONS

D. FRONT KEY CONTROL



1. POWER ON/OFF()

Turns the power ON or OFF. There will be a few seconds delay before the display appears.

2. MENU / EXIT

Activates and exits the On Screen Display.

3. SOURCE/SELECT

Select PC or video source.

Select On Screen Display menu

4 / 5. ▼ / ▲

This button allows user to enter the sub-menu of the activated function

6 / 7. ◀ VOL ▶

Adjust the volume / Adjust menu settings.

8. IR Sensor

Remote controller sensor.

9. POWER LED

The power LED(next to the power switch) lights with green when the power is turned ON.

The power is turned off by pressing the power switch again and the power LED goes Red.

CONTROLS AND FUNCTIONS

OSD MENU DESCRIPTION

A: CUSTOM MENU (Only Video mode)



Press the MENU button and then up(▲) / down(▼) button to select the Custom menu.



Press the up(▲) / down(▼) button to select Custom sub menu.

Press the left(◀) / right(▶) button to adjust picture setting.

Press the MENU button to save.

Brightness: Increase or decrease the intensity of the image.

Contrast: Increase or decrease the intensity (lightness or dimness) of the image.

Color: Increase or decrease the colour of the picture.

Tint: Increase or decrease the tint of the picture.

Sharpness: Increase or decrease the sharpness of the picture.

CONTROLS AND FUNCTIONS

A: CUSTOM MENU (Only PC mode)



Press the MENU button and then up(▲) / down(▼) button to select the Custom menu.



Press the up(▲) / down(▼) button to select Custom sub menu.

Press (◀) / right(▶) button to adjust picture setting.

Press the MENU button to save.

CONTROLS AND FUNCTIONS

B. Picture / Sound Menu(Only Video mode)



Press the MENU button and then up(▲) / down(▼) button to select the Picture / Sound.

Press the right(▶) or ENTER button.

1. Picture Mode



Press the up(▲) / down(▼) button to select the Picture Mode.

Press the right(▶) or ENTER button and then press up(▲) / down(▼) button to select the desired Picture Mode.

Press the MENU button to save.

CONTROLS AND FUNCTIONS

2. Color Tone

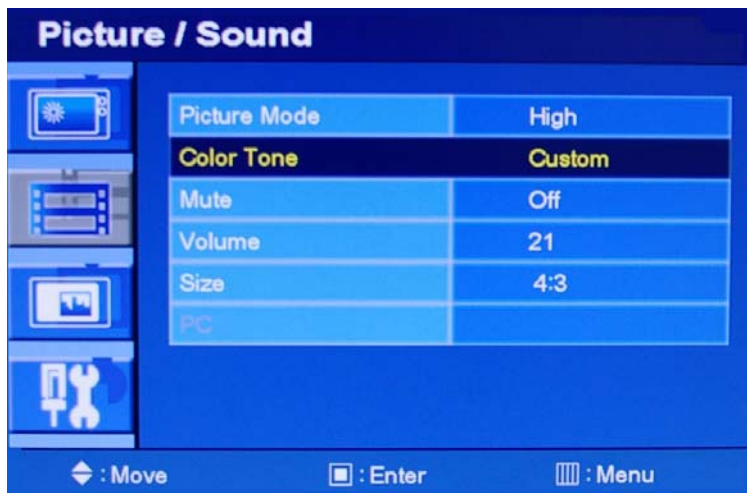

Press the up(▲) / down(▼) button to select the Color Tone.



Press the (▶) or ENTER button and then up(▲)/down(▼) button to select the desired color tone.
Press the MENU button to save.

CONTROLS AND FUNCTIONS

3. Mute

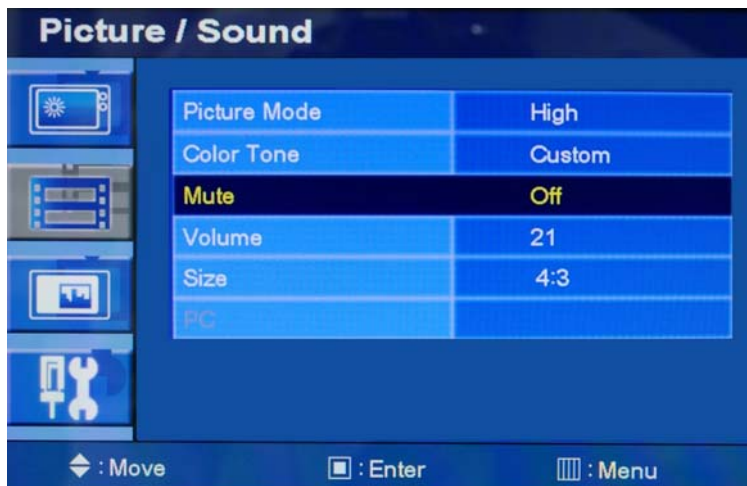

Press the up(▲) / down(▼) button to select the Mute.

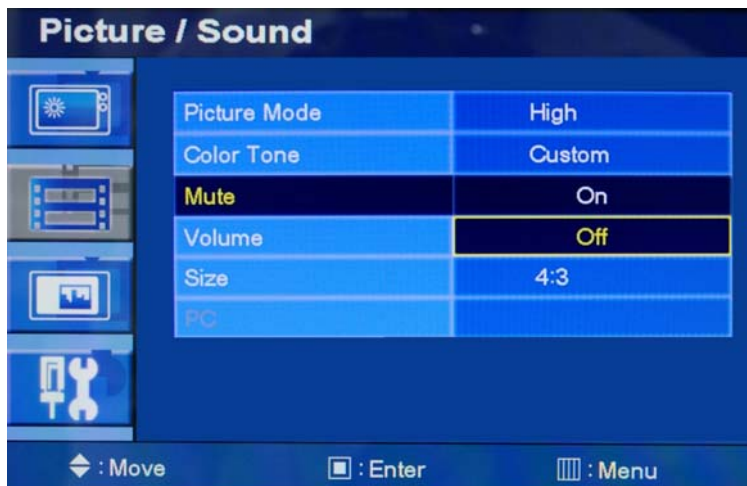

Press the (▶) or ENTER button and then up(▲)/down(▼) button to select the desired Mute.
Press the MENU button to save.

CONTROLS AND FUNCTIONS

4. Volume

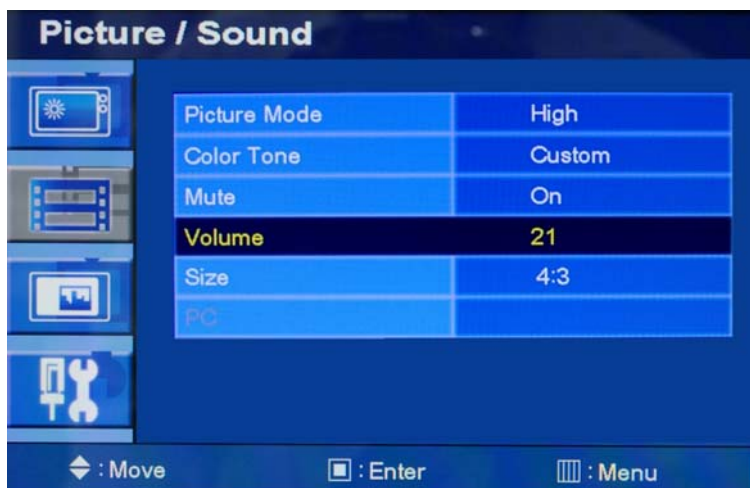

Press the up(▲) / down(▼) button to select the Volume.

Press (◀) /right(▶) button to adjust Volume.

Press the MENU button to save.

5. Size



Press the up(▲) / down(▼) button to select the Size.

CONTROLS AND FUNCTIONS



Press the (▶) or ENTER button and then up(▲)/down(▼) button to select the desired Size.
Press the MENU button to save.

6. PC (Only PC mode)

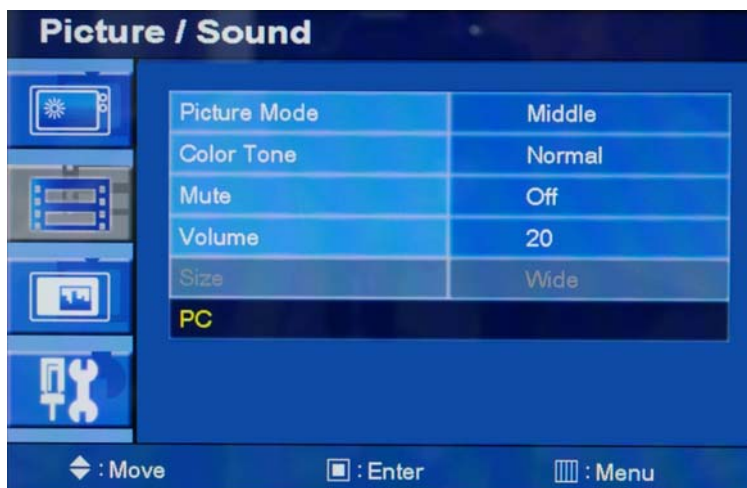

Press the up(▲) / down(▼) button to select the PC
Press the ▶ or ENTER button

CONTROLS AND FUNCTIONS

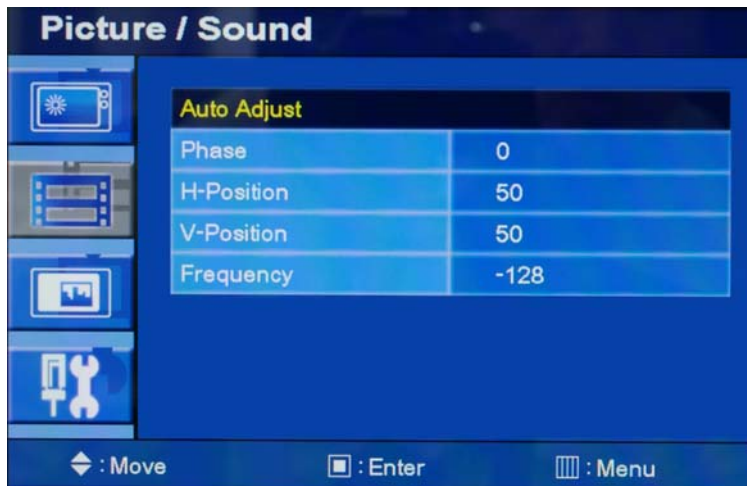

Press the up(▲) / down(▼) button to select PC sub menu

Press the right(▶) or ENTER button and then left (◀) /right(▶) button to adjust PC setting.

Press the MENU button to save.

Auto Adjust: Auto geometry adjustment

Phase: Adjust the number of horizontal picture elements.

H. position: Move image horizontally on screen right or left.

V. position: Move image vertically on screen up or down.

Frequency: Adjust the vertical noise of screen image.

C. PIP MENU

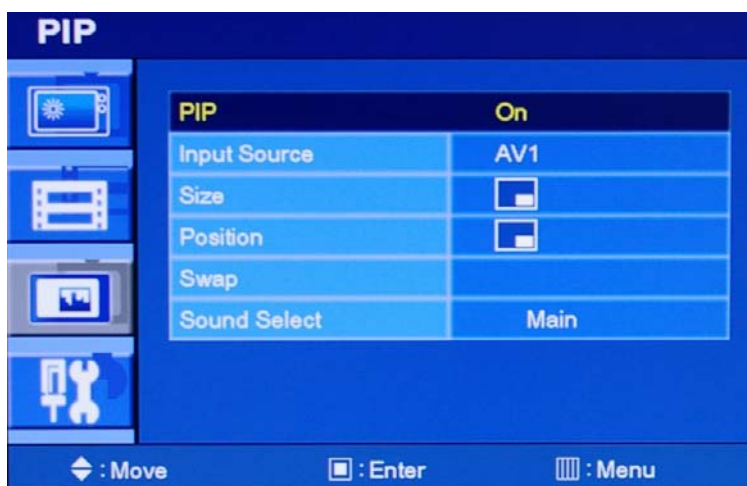

Press the MENU button and then up(▲) / down(▼) button to select the PIP menu.

Press the right(▶) or ENTER button.

INSTRUCTION MANUAL16

CONTROLS AND FUNCTIONS

1. PIP

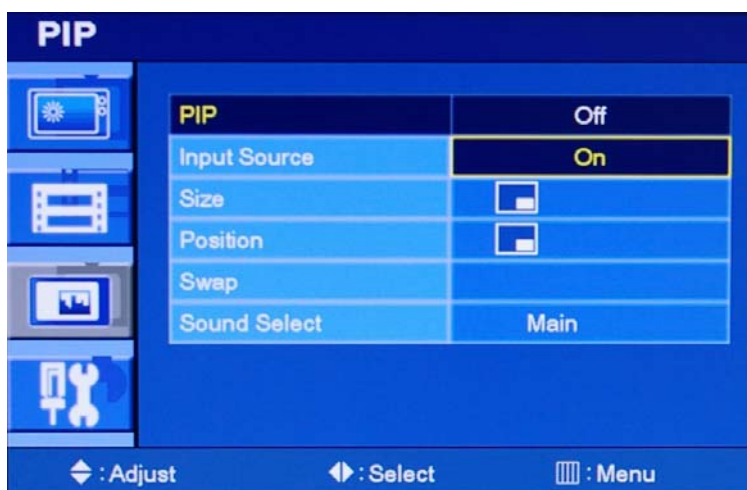

Press the up(▲) / down(▼) button to select the PIP.

Press the right(▶) or ENTER button and then press up(▲) / down(▼) button to select the On or Off.

Press the MENU button to save.

2. Input Source

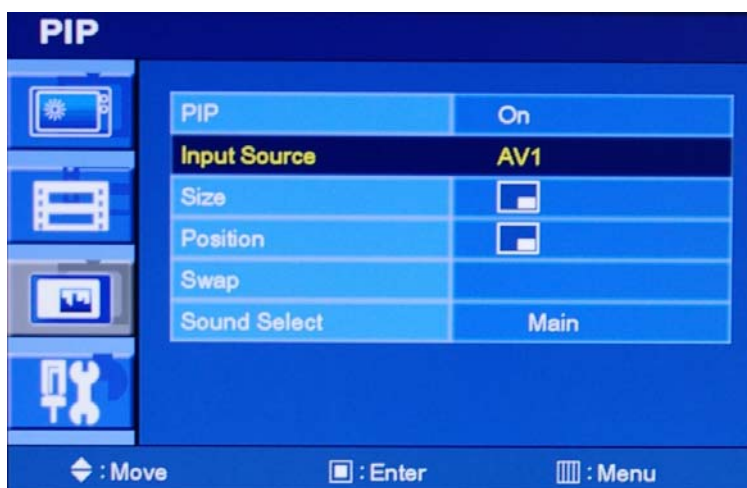

Press the up(▲) / down(▼) button to select the Input Source.

CONTROLS AND FUNCTIONS

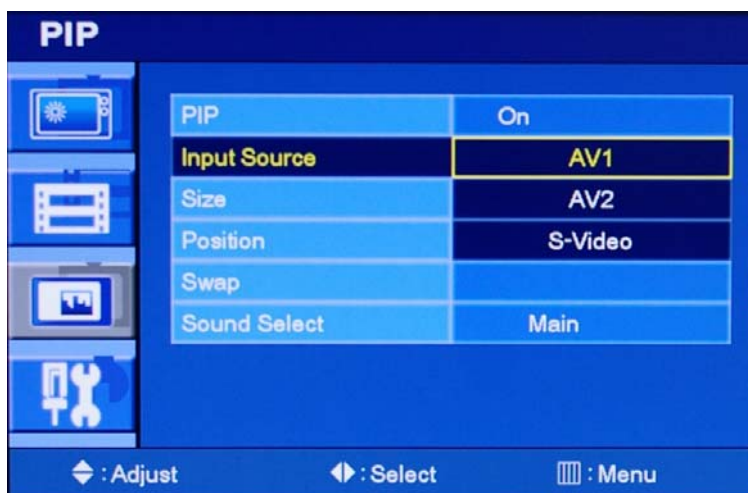

Press the right(▶) or ENTER button and then press up(▲) / down(▼) button to select the desired Input Source.

Press the MENU button to save.

3. Size

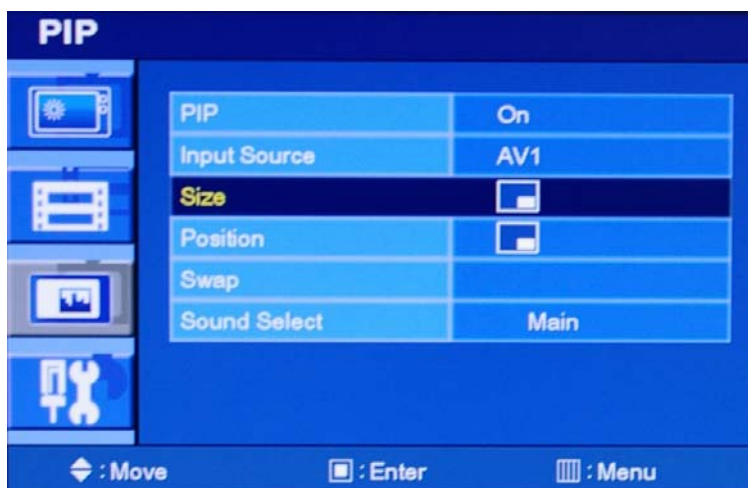

Press the up(▲) / down(▼) button to select the Size.

CONTROLS AND FUNCTIONS

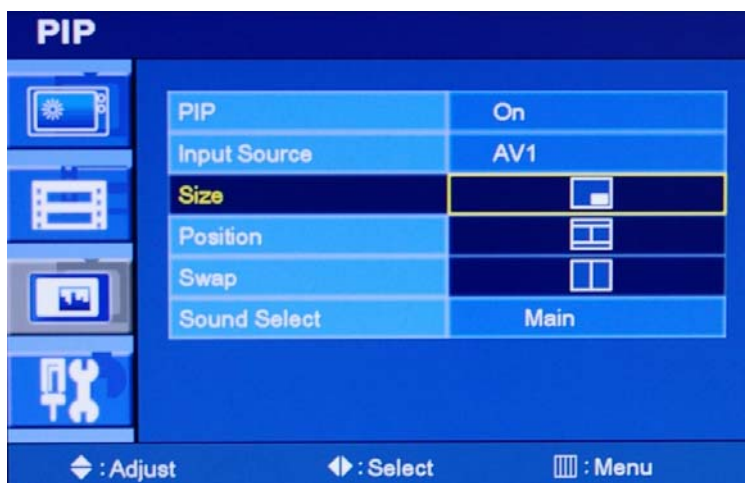

Press the right(▶) or ENTER button and then press up(▲) / down(▼) button to select the desired Size.

Press the MENU button to save.

4. Position

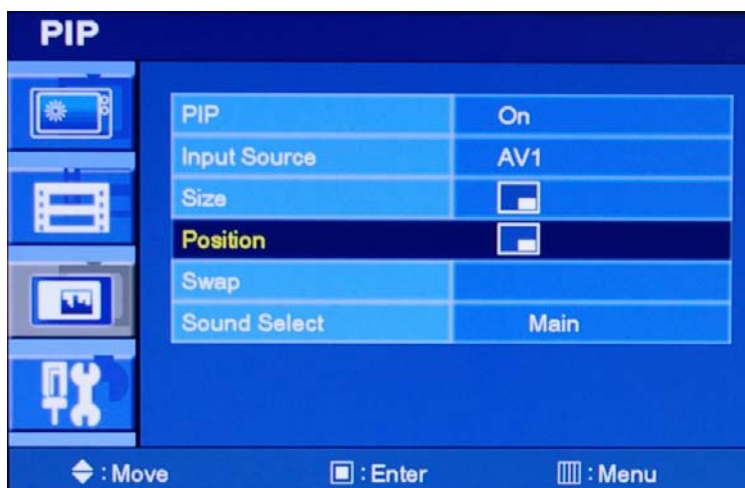

Press the up(▲) / down(▼) button to select the Position.

CONTROLS AND FUNCTIONS

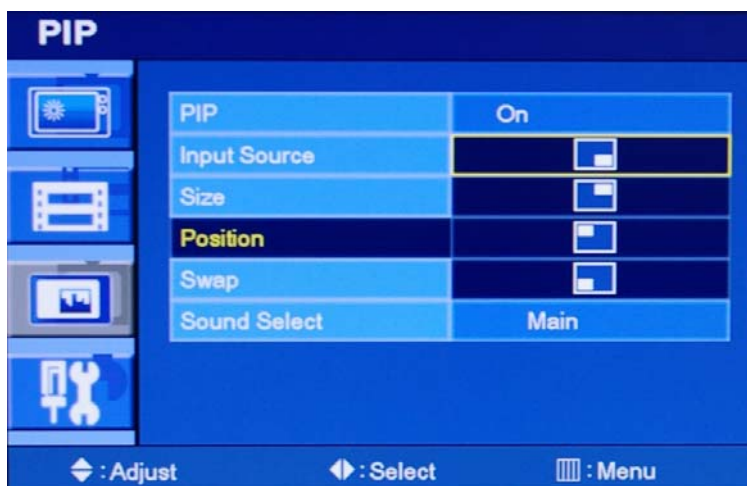

Press the right(▶) or ENTER button and then press up(▲) / down(▼) button to select the desired Position.

Press the MENU button to save.

5. Swap



Press the up(▲) / down(▼) button to select the Swap.

Press the right(▶) or ENTER button

CONTROLS AND FUNCTIONS

5. Sound Select

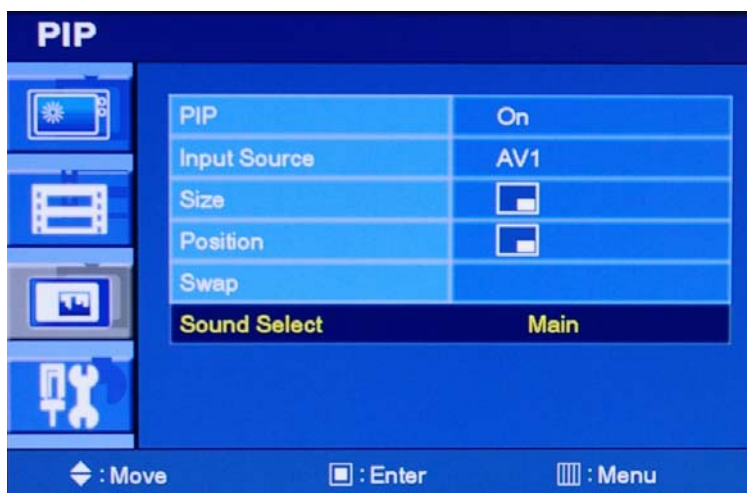

Press the up(▲) / down(▼) button to select the Sound Select.

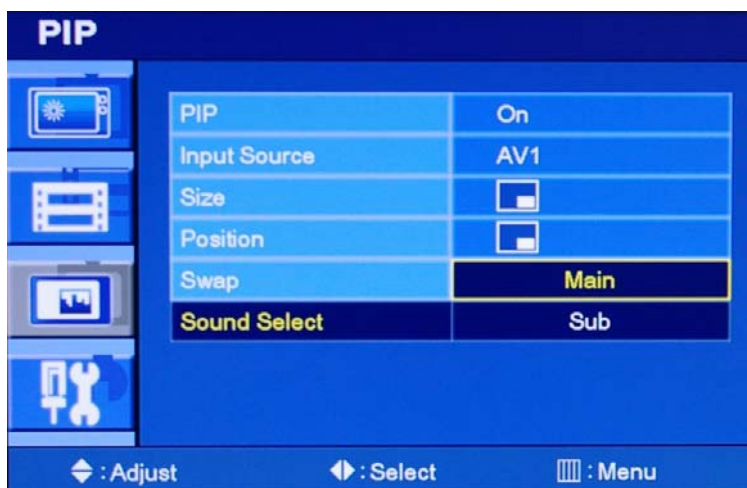

Press the right(▶) or ENTER button and then press up(▲) / down(▼) button to select the desire Sound Select.

Press the MENU button to save.

CONTROLS AND FUNCTIONS

D. SETUP MENU



Press the MENU button and then up(▲) / down(▼) button to select the Setup menu.
Press the right(▶) or ENTER button.

1.Reset



Press ENTER button to select the reset

Reset: Select to reset all setting to the factory default values.

CONTROLS AND FUNCTIONS

2. Language



Press the up(▲) / down(▼) button to select the Language menu.
Press the right(▶) or ENTER button.



Press the up(▲) / down(▼) button to select language.
Press the MENU button to save.

CONTROLS AND FUNCTIONS

3. OSD Tone



Press the up(▲) / down(▼) button to select the OSD tone menu.
Press the right(▶) or ENTER button



Press the up(▲) / down(▼) button to select the desire OSD Tone.
Press the MENU button to save.

CONTROLS AND FUNCTIONS

4. Blue Screen



Press the up(▲) / down(▼) button to select the blue screen.
Press the right(▶) or ENTER button.

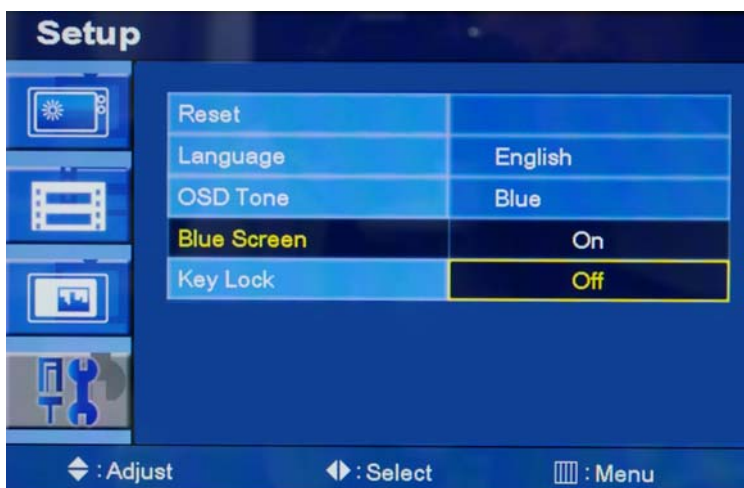

Press the up(▲) / down(▼) button to select on or off.
Press the MENU button to save.

CONTROLS AND FUNCTIONS

5. Key Lock



Press the up(▲) / down(▼) button to select the key lock menu.
Press the right(▶) or ENTER button



Press the up(▲) / down(▼) button to select on or off
Press the MENU button to save.

MOUNTING GUIDE

Wall mount installation:

- 1) Remove the monitor stand bracket assembled with the monitor.
- 2) Use the VESA standard mounting design and the 100mm hole pattern on the back panel to install the LCD monitor to the (Optional) mounting bracket sold separately. (Screws provided with the mounting bracket.)

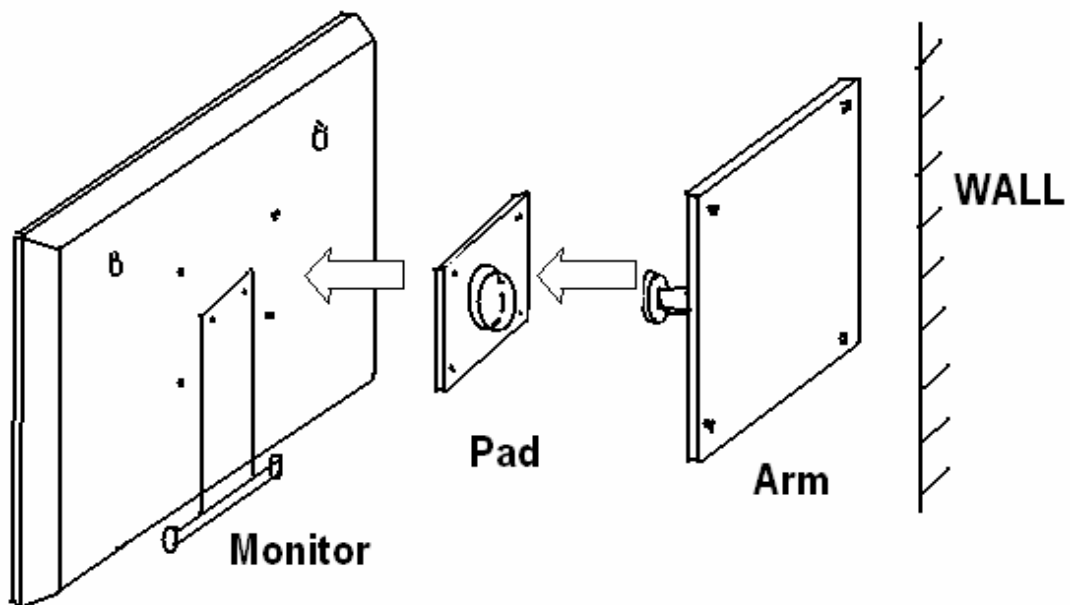

D-SUB CONNECTOR PIN ASSIGNMENTS

► PIN ASSIGNMENTS

Pin 1	RED VIDEO	9	
2	GREEN VIDEO	10	SIGNAL CABLE DETECT
3	BLUE VIDEO	11	GROUND
4	GROUND	12	SDA(for DDC)
5	GROUND	13	H-SYNC.(or H+V SYNC.)
6	RED GROUND	14	V-SYNC.
7	GREEN GROUND	15	SCL(for DDC)
8	BLUE GROUND		

D-SUB

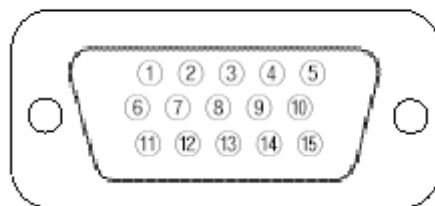

► ACCESSORY

1. POWER CORD
2. USER'S MANUAL
3. PC cable
4. Adaptor
5. Remote Control
6. Batteries
7. Wall mount (Option)
8. Rack mount (Option)

POWER MANAGEMENT

This monitor features a power management system to “power down” upon receipt of the VESA DPMS(The display power management signaling) from a VESA DPMS video card. The VESA DPMS-compliant video card performs this signaling system through not sending horizontal, vertical, or sync signal.

This monitor enters an appropriate mode through identifying each of the three modes of the signaling system.

POWER CONSUMPTION

MODE	POWER CONSUMPTION
ON	< 50W
STANDBY	< 11W
SUSPEND	< 11W
ACTIV OFF	< 8.5W

LED INDICATOR

The power management feature of the monitor is comprised of four stages: On(Green), Standby, Suspend, Active off(Red on/off 1 sec) and Unsupported mode(Green).

MODE	LED COLOR	MONITOR OPERATION
ON	GREEN	Normal Operation
STANDBY	RED ON/OFF 1 SEC	Screen blanks after preset idle time And some electronic circuits or all Circuitry in the monitor shut down.
SUSPEND		
ACTIV OFF		
UNSUPPORTES MODE	GREEN	Normal operation but the on screen Display will show error message
POWER OFF	RED	Not Operation

SPECIFICATIONS

	17"	19"
LCD- Type	17" Diagonal AM-TFT(Active-Matrix)	19" Diagonal AM-TFT(Active-Matrix)
	Pixel pitch(mm) : 0.264(H) 0.264(V)	Pixel pitch(mm) : 0.294(H) 0.294(V)
	BRIGHTNESS: 300cd/m ² (Typical)	BRIGHTNESS: 300cd/m ² (Typical)
	CONTRAST RATIO: 1000:1(Typical)	CONTRAST RATIO: 1000:1(Typical)
	VIEWING ANGLE: 160°/160°(H/V)	VIEWING ANGLE: 160°/160°(H/V)
	RESPONSE TIME: 5msec(Typical)	RESPONSE TIME: 5msec(Typical)
RESOLUTION (H x V)	1280X1024 @60Hz	1280X1024 @60Hz
FREQUENCY	HORIZONTAL: 31- 64KHz VERTICAL: 56-75Hz	HORIZONTAL: 31- 64KHz VERTICAL: 56-75Hz
INPUT SIGNAL	VIDEO(2ch input 1.0Vp-p, 75Ω terminated, loop-through out)	VIDEO(2ch input 1.0Vp-p, 75Ω terminated, loop-through out)
	S-VIDEO(1ch input (Y/C) , loop-through out)	S-VIDEO(1ch input (Y/C) , loop-through out)
	COMPONENT(Y,Pb,Pr, Sound L/R)	COMPONENT(Y,Pb,Pr, Sound L/R)
	DVI I/D(Digital Video Interface)	DVI I/D(Digital Video Interface)
	PC RGB	PC RGB
	AV(composite) Sound in	AV(composite) Sound in
	PC Stereo Sound	PC Stereo Sound
ACTIVE DISPLAY AREA (W x H)	337.9 mm x 270.3 mm	376.32mm X 301mm
PACKING DIMENSIONS (W x H x D)	477mm X 543mm X 205mm	477mm X 543mm X 205mm
WEIGHT	Net Weight : TBD	Net Weight : TBD
	Gross Weight : TBD	Gross Weight : TBD
ELECTRICAL RATINGS	DC 12V/ 4.12A	DC 12V/ 4.12A

▶▶ NOTE :

Technical specifications are subject to change without notice.

TROUBLESHOOTING GUIDE

TROUBLE	TROUBLESHOOTING TIP
No image on display screen	<ol style="list-style-type: none"> 1. Check that power cord of the Monitor have been connected securely into wall outlet or grounded extension cable or strip. 2. Power switch should be in the ON position and LED is lit. 3. Check that the Brightness and/or the Contrast adjustments of the Display have not been turned down to minimum levels.
“Going to Sleep” message on screen	<ol style="list-style-type: none"> 1. The signal cable should be completely connected to the video card/computer. 2. The video card should be completely seated in its slot and the computer is switched ON.
Display image is not centered, too small or too large in PC mode	Push the down key in front side or Auto key in remoon.
Vertical or Horizontal noise is present in the picture	Adjust Clock and Phase in the OSD.

WEEE Symbols

Correct Disposal of This Product (Waste Electrical & Electronic Equipment)

(Applicable in the European Union and other European countries with separate collection systems)

This marking shown on the product or its literature, indicates that it should not be disposed with other household wastes at the end of its working life. To prevent possible harm to the environment or human health from uncontrolled waste disposal, please separate this from other types of wastes and recycle it responsibly to promote the sustainable reuse of material resources. Household users should contact either the retailer where they purchased this product, or their local government office, for details of where and how they can take this item for environmentally safe recycling. Business users should contact their supplier and check the terms and conditions of the purchase contract. This product should not be mixed with other commercial wastes for disposal.



Free Manuals Download Website

<http://myh66.com>

<http://usermanuals.us>

<http://www.somanuals.com>

<http://www.4manuals.cc>

<http://www.manual-lib.com>

<http://www.404manual.com>

<http://www.luxmanual.com>

<http://aubethermostatmanual.com>

Golf course search by state

<http://golfingnear.com>

Email search by domain

<http://emailbydomain.com>

Auto manuals search

<http://auto.somanuals.com>

TV manuals search

<http://tv.somanuals.com>