

DVD DVD  
DVD DVD

## 7" TFT LCD KITCHEN TV with DVD/CD and AM/FM Radio

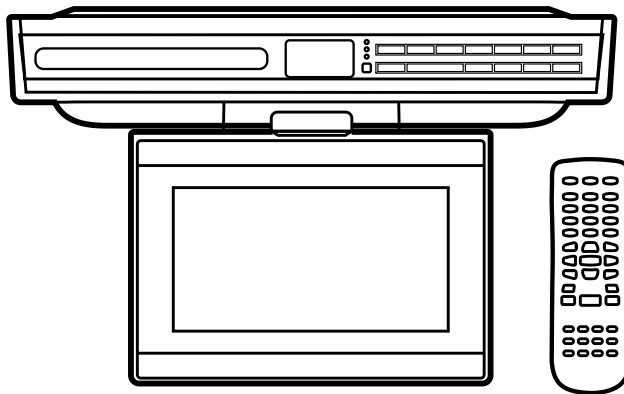

### OWNER'S MANUAL



TV TV TV  
TV TV TV

# SAFETY PRECAUTIONS

The following marks and symbols are located on back of the unit.

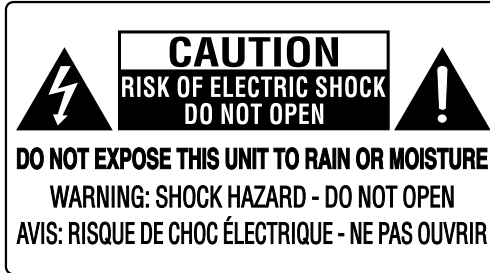

The lightning flash with an arrowhead symbol, within the equilateral triangle, is intended to alert the user to the presence of uninsulated "dangerous voltage" within the product's enclosure that may be of sufficient magnitude to constitute a risk of electric shock to persons.



The exclamation point within the equilateral triangle is intended to alert the user to the presence of important operating and maintenance (servicing) instructions in this owner's manual.

Caution marking is located on back enclosure of the unit.

## On Placement

- Do not use the unit in places which are extremely hot, cold, dusty, or humid.
- Do not restrict the air flow of the unit by placing it in a place with poor air flow, by covering it with a cloth, or by placing it on carpeting.

## On Safety

- When connecting or disconnecting the AC power cord, grip the plug and not the cord itself. Pulling the cord may damage it and create a hazard.

## On Condensation

- When left in a heated room where it is warm and damp, water droplets or condensation may form inside the unit. When there is condensation inside the unit, the unit may not function normally. Let the unit stand for 1 to 2 hours before turning the power on, or gradually heat the room and allow the unit to dry before use.

# SAFETY PRECAUTIONS

## ***FCC Information***

This device complies with Part 15 of the FCC rules. Operation is subject to the following two conditions:

- (1) This device may not cause harmful interference, and
- (2) This device must accept any interference received, including interference that may cause undesired operation.

**NOTE:** This equipment has been tested and found to comply with the limits for a Class B digital device, pursuant to part 15 of the FCC Rules. These limits are designed to provide reasonable protection against harmful interference in a residential installation. This equipment generates, uses, and can radiate radio frequency energy and, if not installed and used in accordance with the instructions, may cause harmful interference to radio communications. However, there is no guarantee that interference will not occur in a particular installation. If this equipment does cause harmful interference to radio or television reception, which can be determined by turning the equipment off and on, the user is encouraged to try to correct the interference by one or more of the following measures:

- Reorient or relocate the receiving antenna.
- Increase the separation between the equipment and receiver.
- Connect the equipment into an outlet on a circuit different from that to which the receiver is connected.
- Consult the dealer or an experienced radio/TV technician for help.

**WARNING:** Changes or modifications to this unit not expressly approved by the party responsible for compliance could void the user authority to operate the equipment.

This Class B digital apparatus complies with Canadian ICES-003.

Shielded cables must be used with this unit to ensure compliance with the Class FCC limits.



**WARNING:** Should any trouble occur, disconnect the AC power cord and refer servicing to a qualified technician.

## ***Notes on Copyright***

It is forbidden by law to copy, broadcast, show, broadcast on cable, play in public, or rent copyrighted material without permission.

Apparatus Claims of "U.S. Patent Nos. 4,907,093; 5,315,448; and 6,516,132." licensed for limited viewing uses only.

This product incorporates copyright protection technology that is protected by U.S. patents and other intellectual property rights. Use of this copyright protection technology must be authorized by Macrovision, and is intended for home and other limited viewing uses only unless otherwise authorized by Macrovision. Reverse engineering or disassembly is prohibited.

# IMPORTANT SAFETY INSTRUCTIONS

1. Read these instructions.
2. Keep these instructions.
3. Heed all warnings.
4. Follow all instructions.
5. Do not use this apparatus near water.
6. Clean only with a dry cloth.
7. Do not block any of the ventilation openings. Install in accordance with the manufacturer's instructions.
8. Do not install near any heat sources such as radiators, heat registers, stoves, or other apparatus (including amplifiers) that produce heat.
9. Do not defeat the safety purpose of the polarized or grounding-type plug. A polarized plug has two blades with one wider than the other. A grounding type plug has two blades and a third grounding prong. The wide blade or the third prong are provided for your safety. When the provided plug does not fit into your outlet, consult an electrician for replacement of the obsolete outlet.
10. Protect the power cord from being walked on or pinched particularly at plugs, convenience receptacles, and the point where they exit from the apparatus.
11. Only use attachments/accessories specified by the manufacturer.
12. Use only with a cart, stand, tripod, bracket, or table specified by the manufacturer, or sold with the apparatus. When a cart is used, use caution when moving the cart/apparatus combination to avoid injury from tip-over.
13. Unplug this apparatus during lightning storms or when unused for long periods of time.
14. Refer all servicing to qualified service personnel. Servicing is required when the apparatus has been damaged in any way, such as the power-supply cord or plug is damaged, liquid has spilled or objects have fallen into the apparatus, the apparatus has been exposed to rain or moisture, does not operate normally, or has been dropped.



**Portable Cart Warning**

# TABLE OF CONTENTS

<b>Safety Precautions</b> .....	1-2	<b>Repeat Playback</b> .....	19
<b>Important Safety Instructions</b> .....	3	<b>DVD Programmable Memory</b> .....	20
<b>Table of Contents</b> .....	4	DVD Programmable Memory .....	20
<b>Disc Formats</b> .....	5	<b>Viewing JPEG FILES</b> .....	20
<b>Accessories</b> .....	6	<b>Play Modes for CD or JPEG Disc</b> .....	21
<b>Remote Control</b> .....	6	<b>Customizing the Function Settings</b> .....	22-23
<b>Control Reference Guide</b> .....	7-9	Language .....	22
<b>Mounting Instructions</b> .....	10-11	Video .....	22
<b>Connections</b> .....	12-13	Default .....	23
Connecting the TV Antenna .....	12	<b>Using the TV</b> .....	24
Connecting the Unit to a TV or		<b>TV MENU</b> .....	25-26
other Video Equipment .....	12	<b>Listening to the Radio</b> .....	27
Connecting the Unit to a Stereo Receiver		<b>Troubleshooting Guide</b> .....	28
or Amplifier .....	12	<b>Maintenance</b> .....	29
Plugging in the Unit .....	13	<b>Specifications</b> .....	29
<b>Monitor Operation</b> .....	13	<b>Limited Warranty</b> .....	30-31
<b>Unit Operation</b> .....	14		
<b>Sound System</b> .....	14		
<b>Setting the Clock</b> .....	15		
<b>Setting the Cooking Timer</b> .....	15		
<b>Playing a Disc</b> .....	16-18		
Playing a Disc .....	16		
Pausing Playback .....	16		
Stopping Playback .....	16		
Skipping to a Different Chapter/Track .....	16		
Fast Forward/Fast Reverse .....	16		
Angle Selection .....	17		
Subtitle Selection .....	17		
Audio Selection .....	17		
Display Function .....	18		
<b>Special Functions</b> .....	18		
Locating a Specific Title/Chapter/Time .....	18		
Locating a Specific Track .....	18		
Setting Favorite Bookmark			
During Playback .....	19		

# DISC FORMATS

The unit can play



DVDs  
[8cm/12cm disc]



**CD-R CD-RW**

Compatible



Audio CDs  
[8cm/12cm disc]

## Region Management Information

Region Management Information: This unit is designed and manufactured to respond to the Region Management Information that is encoded on DVDs. If the region number printed on the DVD does not correspond to the region number of this unit, this unit cannot play that disc.



The region number of this unit is 1.

## Disc Function or Operation that is Not Available

When the "Ⓢ" symbol appears on the screen, it indicates that the function or operation attempted is not available at that time. This occurs because the DVD manufacturer determines the specific functions. Certain functions may not be available on some discs. Be sure to read the documentation provided with the DVD.

## Icons Used on DVDs

Sample Icons

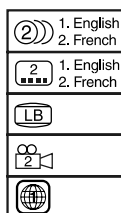

- Language selections for audio
- Language selections for subtitles
- Screen aspect ratio
- Multiple camera angles
- Region code indicator

## Note:

- When playing a CD-G (Graphics) or CD EXTRA disc, the audio portion will be played, but the graphic images will not be shown.

## Titles, Chapters and Tracks

- DVDs are divided into "titles" and "chapters". If the disc has more than one movie on it, each movie would be a separate "title". "Chapters" are sections of titles.

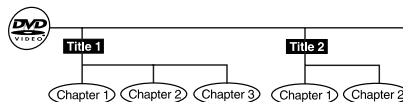

- Audio CDs are divided into "tracks". A "track" is usually one song on an Audio CD.



Note : Numbers identify each title, chapter, and track on a disc. Most discs have these numbers recorded on them, but some do not.

### Notes on Unauthorized Discs

You may not be able to play back some DVDs on this unit if they were purchased from outside your geographic area or made for business purposes.

# ACCESSORIES

## *Please Check and Identify the Included Accessories.*

<input type="checkbox"/>	Remote control .....	x 1
<input type="checkbox"/>	AAA 1.5V battery .....	x 2
<input type="checkbox"/>	Mounting template .....	x 1
<input type="checkbox"/>	1.06" (27mm) spacers .....	x 4
<input type="checkbox"/>	.57" (14.4mm) spacers .....	x 4
<input type="checkbox"/>	.32" (8.2mm) spacers .....	x 4
<input type="checkbox"/>	#M 5 x 69 mm screws .....	x 4
<input type="checkbox"/>	#M 5 x 40 mm screws .....	x 4

## REMOTE CONTROL

### *Using the Remote Control*

- This remote control is magnetic and can be attached to most refrigerators. Some refrigerators panels are not metallic. In this case, try attaching the magnetic remote control to the side of the refrigerator.
- Point the remote control at the REMOTE SENSOR located on the unit.
- When there is a strong ambient light source, the performance of the infrared REMOTE SENSOR may be degraded, causing unreliable operation.
- The recommended effective distance for remote operation is about 16 feet (5 meters).

### *To Install Batteries*

1. Open the battery door.
2. Insert two AAA batteries.

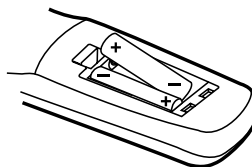
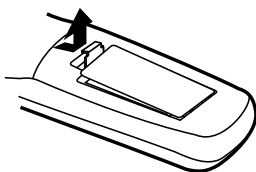

### *Battery Replacement*

When the batteries become weak, the operating distance of the remote control is greatly reduced and you will need to replace them.

Caution: Danger of explosion if battery is incorrectly replaced. Replace only with the same or equivalent type.

### **Notes:**

- Do not place the remote control near magnetic devices or magnetic cards.
- If the remote control is not going to be used for a long time, remove the batteries to avoid corrosion damage caused by battery leakage.
- Do not mix old and new batteries. Do not mix ALKALINE, standard (CARBON-ZINC) or rechargeable (NICKEL-CADMIUM) batteries.
- Always remove batteries as soon as they become weak.
- Weak batteries can leak and severely damage the remote control.
- **WARNING:** Do not dispose of batteries in a fire. Batteries may explode or leak.

# CONTROL REFERENCE GUIDE

## Remote Control

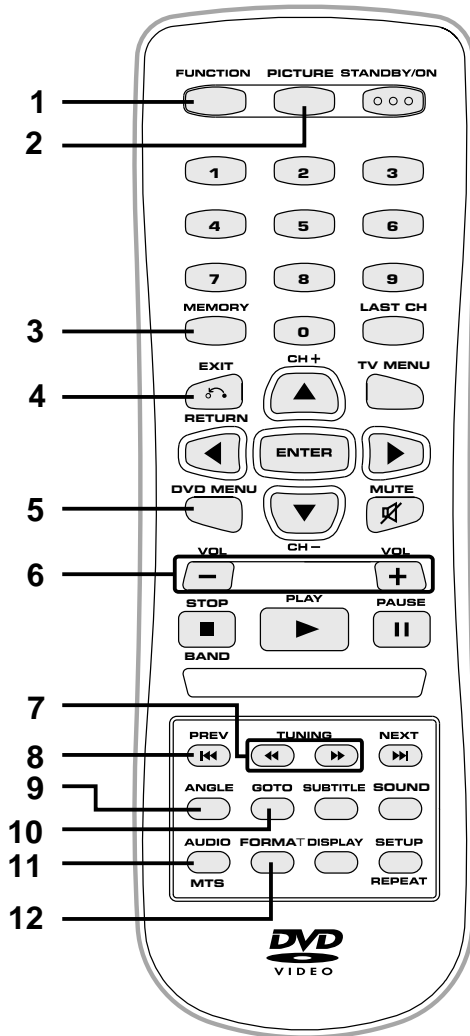





- 1) **FUNCTION Button**  
Use to select DVD, TV or RADIO mode.
- 2) **PICTURE Button**  
Selects a picture mode to match the type of show you are watching.
- 3) **MEMORY Button**  
Sets title/chapter in a favorite order. Enter the number of a selected station.
- 4) **EXIT/RETURN ↻ Button**  
Press to exit the TV menu and return directly to normal viewing.
- 5) **DVD MENU Button**  
Press to enter the main menu of the DVD you are watching.
- 6) **VOLUME (+/-) Buttons**  
Adjusts the volume.
- 7) **◀ / ▶ TUNING Buttons**  
◀◀ : Fast reverse playback.  
▶▶ : Fast forward playback.  
◀◀ TUNING ▶▶ : Scans all available radio stations.
- 8) **◀◀ PREV Button**  
Selects previous titles, chapters or tracks on a disc.
- 9) **ANGLE Button**  
During DVD playback, switch the camera angle of the video presentation when scenes with multiple camera angles are recorded on a DVD.
- 10) **GOTO Button**  
Goes directly to a location on a DVD/CD.
- 11) **AUDIO Button**  
Selects audio soundtracks of a DVD or change the output mode of a CD. Press to select MONO sound or STEREO sound.
- 12) **FORMAT Button**  
Press to select the picture format.

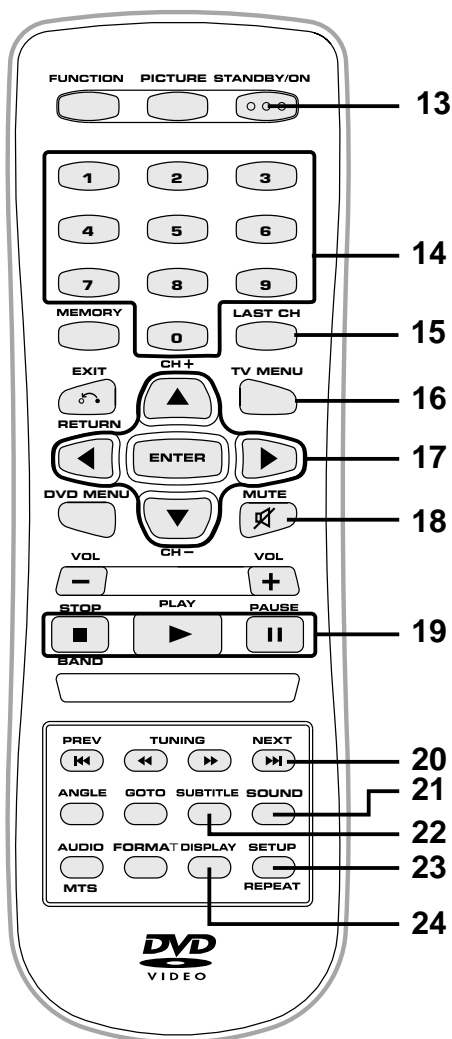

# CONTROL REFERENCE GUIDE

## Remote Control



- 13) STANDBY/ON Button**  
Turns on the unit and puts it in standby mode.
- 14) Number (0-9) Buttons**
- 15) LAST CH Button**  
Press to switch repeatedly between the last two channels displayed.
- 16) TV MENU Button**  
Press to display the on-screen TV menu.
- 17) CURSOR (▲, ▼, ◀, ▶) Buttons**  
Use to highlight selections on a screen and make adjustments to certain settings.  
  - ▲ CH+ / ▼ CH- buttons**  
Use to change TV channels.
- ENTER Button**  
Confirm selections on a menu screen.
- 18) MUTE  Button**  
Press to turn off the sound.
- 19)  STOP/BAND Button**  
Stops playback.  
Switches between AM and FM.
- ▶ PLAY Button**  
Starts playback.
- ⏸ PAUSE Button**  
Pauses playback, frames advance.
- 20)  NEXT Button**  
Selects next titles, chapters or tracks on a disc.
- 21) SOUND Button**  
Press to select a sound mode during DVD playback, watching TV or radio playing.
- 22) SUBTITLE Button**  
Selects one of the subtitle languages programmed on a DVD.
- 23) SETUP Button**  
Enters and exits the SETUP menu of the DVD.  
  - REPEAT Button**  
Repeats chapter or title of a DVD.  
Repeats single track or whole CD.
- 24) DISPLAY Button**  
Changes disc status information displayed on the screen.

# CONTROL REFERENCE GUIDE

## Unit

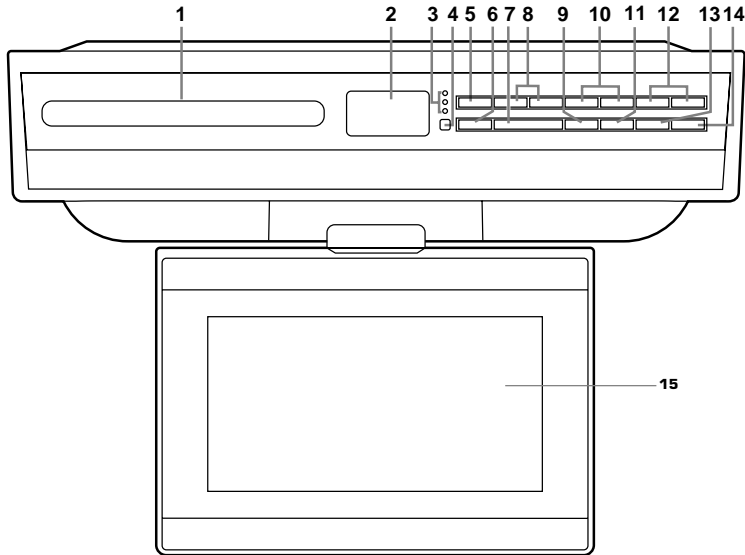

- 1) **Disc Tray**  
Opens or closes the tray by pressing OPEN/CLOSE button.  
Place a disc on the disc tray, label side up.
- 2) **Display Window**  
Displays system information.
- 3) **POWER ON Indicators**  
\* **DVD** : DVD indicator  
\* **TV** : TV indicator  
\* **RADIO** : RADIO indicator
- 4) **Remote Sensor**  
Receives the remote control unit signals.
- 5) **⏻ STANDBY/ON Button**  
Turns the unit on and off.
- 6) **⏮ OPEN/CLOSE Button**  
Use to open/close the disc tray.
- 7) **DVD/TV/RADIO Button**  
Use to select DVD, TV or RADIO mode.
- 8) **▶ PLAY Button**  
Press to start or resume playback of a disc.  
**■ STOP/BAND Button**  
Stops playing a disc.  
Switches between AM and FM.  
**◀ ADJUST ▶**  
Makes adjustments to certain settings.
- 9) **SET CLOCK Button**  
Use to set the current time.
- 10) **◀◀ / ▶▶ / ∨ CH ^ Buttons**  
**◀◀ Button**  
Press ◀◀ to go back to previous chapters/tracks.  
**▶▶ Button**  
Press ▶▶ to advance to chapters / tracks.  
Use to search for a station automatically or select presetted stations.  
**∨ CH ^ Buttons**  
Use to skip/search TV channel.
- 11) **TV MENU Button**  
Opens and closes the TV menu.
- 12) **VOLUME +/- Buttons**  
Adjusts the volume levels.
- 13) **TIMER Button**  
Use to set the cooking timer.
- 14) **ENTER Button**  
Use to enter the sub-menu and confirm selections.
- 15) **Screen**

# MOUNTING INSTRUCTIONS

TOOLS NEEDED: 1) Electric drill with 1/4" bit; 2) Phillips-head (cross style) screwdriver.

## STEP 1

If your cabinet does **NOT** have an overhang:

- a) Place the Mounting Template in the desired location inside or underneath the cabinet (whichever has less obstructions, and will be easier for you to reach to drill holes), flush with the front edge of the cabinet and tape it down. Go to **STEP 2**.

If your cabinet **DOES** have an overhang:

- a) Measure the thickness of the cabinet overhang (see Figure 1).

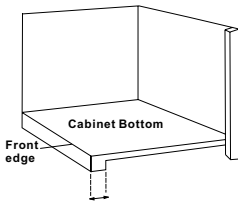

Figure 1

- b) Fold the Mounting Template along the guideline that is closest to the thickness of your cabinet overhang.
- c) Tape Mounting Template to the underside of the cabinet with the folded portion of the Mounting Template flush up against the cabinet overhang (see Figure 2). Go to **STEP 2**.

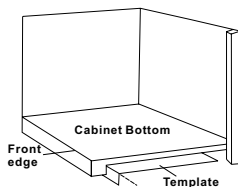

Figure 2

## STEP 2

Use an electric drill with a 1/4" drill bit (not included) to drill all four holes marked on the Mounting Template (see Figure 3). To reduce splintering, place a small piece of masking tape over each hole location before drilling. Go to **STEP 3**.

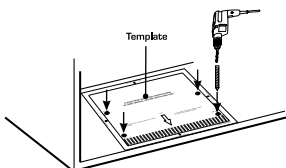

Figure 3

## STEP 3

If your cabinet does **NOT** have an overhang:

- a) Eight screws are included with this unit, but you will only need four of them. Select the screw length which will go completely through your cabinet bottom, and provide at least 3/8" of thread to screw into the main unit.
- b) Insert the four selected screws through each hole from the inside of the cabinet going down (see Figure 4).

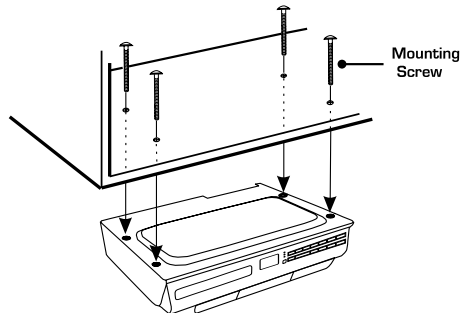

Figure 4

- c) Hold the unit up against the bottom of the cabinet, and align the four holes on the top of the unit with the screws. Partially tighten each screw, but do not fully tighten the screws until all of them have been started.
- d) Gently tighten each screw until they are firmly holding the unit in place.

If your cabinet **DOES** have an overhang:

- a) Eight screws are included with this unit, but you will only need four of them. Select the screw length which will go completely through your cabinet bottom, and extend at least 3/8" past the bottom of your cabinet overhang.
- b) This unit includes three sets of four spacers of various lengths. The spacers can be put together to form longer spacers to accommodate various cabinet overhang thicknesses. Determine the best combination of spacers which is equal to or longer than the cabinet overhang thickness.

(Continued on next page)

# MOUNTING INSTRUCTIONS

(Continued from previous page)

- c) Insert the four selected screws through each hole from the inside of the cabinet going down (see Figure 5).

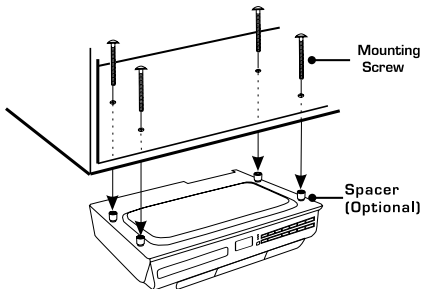

Figure 5

- d) Hold each screw head down and push the unit and spacers onto the screws, then hold the unit up until spacers are firmly against the bottom of the cabinet (and fully nested within each other if you are using multiple spacers for each screw).

- e) Partially tighten each screw, but do not fully tighten the screws until all of them have been started (see Figure 6).

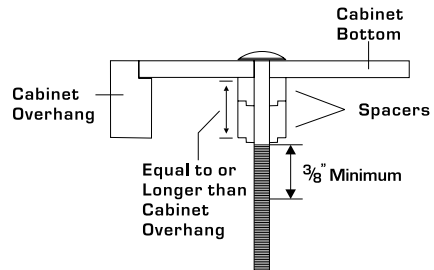

Figure 6

- f) Gently tighten each screw until they are firmly holding the unit in place. The top front edge of the unit should clear the overhang.

## CAUTION

**TO REDUCE THE RISK OF FIRE, DO NOT PLACE ANY HEATING OR COOKING APPARATUS BENEATH THIS UNIT.**

## MOUNTING SUGGESTIONS

- 1) If your cabinet has obstructions inside it which prevent you from using the template, cut out the corresponding area on the template, but do NOT cut out or through the screw holes.
- 2) If your cabinet has obstructions underneath it, which will interfere with the mounting of the unit, remove the obstruction before mounting the unit, or find another location to mount the unit.
- 3) It is recommended that you wear safety glasses while drilling to prevent eye injuries.
- 4) For wood cabinets, you may want to mark the hole locations with a nail, pressed gently but firmly into the wood so that a slight impression is made. This will also help keep the drill bit centered in the right location.
- 5) Hold the drill firmly against the cabinet to keep the drill from "walking".

# CONNECTIONS

## Connecting the TV Antenna

Connect a TV antenna or CATV cable or Satellite system to the TV antenna terminal.

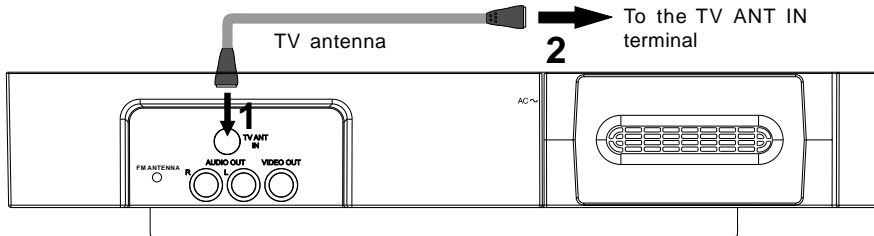

## Connecting the Unit to a TV or other Video Equipment

Use the Audio/Video cable (not supplied). Connect the VIDEO OUT and R/L (right/left) AUDIO OUT jacks on the rear of the unit to the VIDEO IN and R/L (right/left) jacks on your TV or other video equipment.

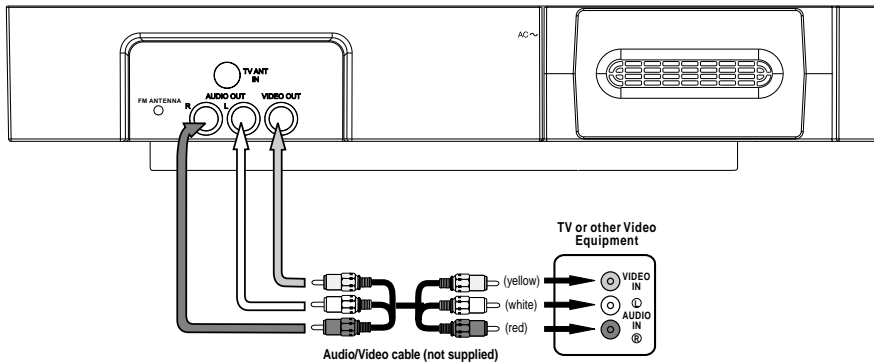

## Connecting the Unit to a Stereo Receiver or Amplifier

### ANALOG CONNECTION

Use the Audio cable (not supplied). Connect the R (right) AUDIO OUT and L (left) AUDIO OUT jacks on the rear of the unit to the R (right) AUDIO IN and L (left) AUDIO IN jacks on your other source.

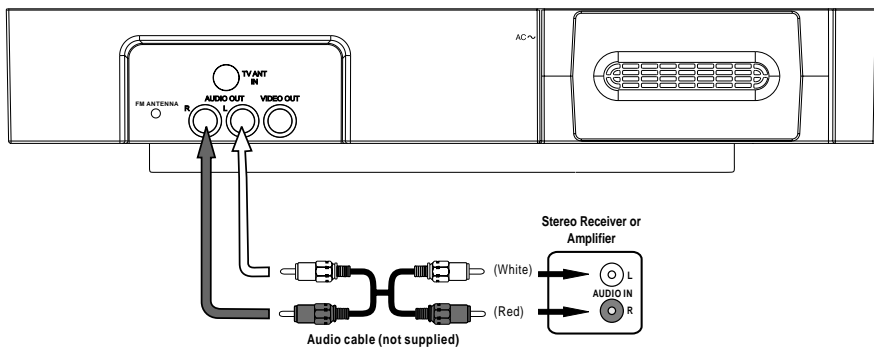

# CONNECTIONS

## Plugging in the Unit

Plug the AC power cord into the wall outlet

- Before plugging in the power cord, make sure the voltage of the unit matches your local voltage.
- Plug the power cord directly into the nearest wall outlet, and wrap the remaining cord around the cord storage knob at the rear of the unit.

**CAUTION: TO PREVENT ELECTRIC SHOCK, MATCH WIDE BLADE OF PLUG TO WIDE SLOT OF WALL OUTLET, THEN FULLY INSERT.**

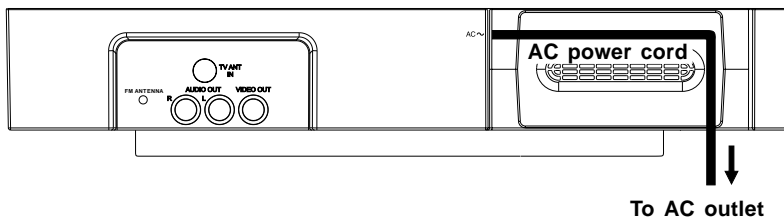

# MONITOR OPERATION

Follow the illustrations below to open the monitor.

1. Gently pull the monitor down from the back, and twist it counter-clockwise so the screen is visible.

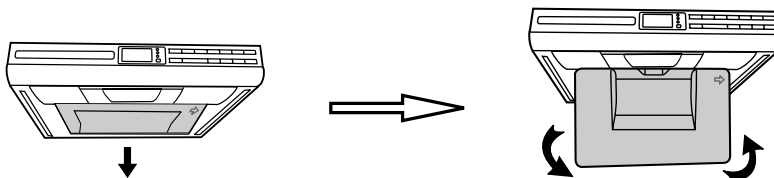

2. The screen can be turned up to 270°. Do NOT force the screen once it stops turning. The screen does NOT turn completely around.

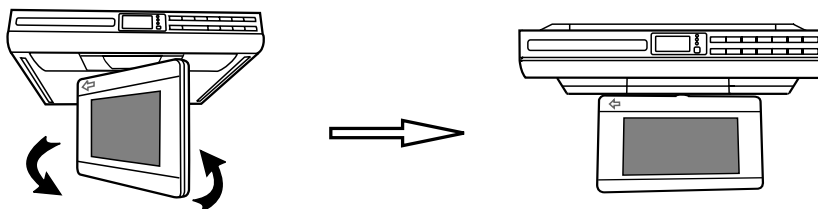

# UNIT OPERATION

## ***Turning the Unit On***

While the power cord is connected and the unit is on standby, power will be consumed and only the clock display will flash.

- Press the **⏻ STANDBY/ON** button to turn the unit on and the DVD indicator lights up.  
After a short period of time, "DVD" will appear on the front display and the DVD logo (start-up picture) will appear on the screen.

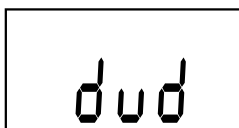

- Press the **DVD/TV/RADIO** button (the **FUNCTION** button on the remote control) to TV mode and the TV indicator lights up.  
After a short period of time, "TV" will appear on the front panel display and the TV program will begin on the screen.

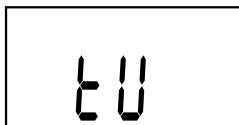

- Press the **DVD/TV/RADIO** button (the **FUNCTION** button on the remote control) to RADIO mode and the radio indicator lights up.  
After a short period of time, "TUNER" and the FM frequency will appear on the front panel display.



# SOUND SYSTEM

## ***Dolby Digital (for DVD)***

Dolby Digital is a technology developed by Dolby Laboratories. Soundtracks encoded in Dolby Digital can reproduce from one to 5.1 discrete channels of excellent quality audio.

The unit automatically recognizes the Dolby Digital bitstream and provides a downmix suitable for two-channel listening. An additional Dolby Digital decoder is required for reproduction of the discrete multi-channel soundtracks available on many DVDs.



Manufactured under license from Dolby Laboratories.

'Dolby' and  the double-D symbol are trademarks of Dolby Laboratories.

## SETTING THE CLOCK

To adjust the clock, the unit must be in standby mode. To enter standby mode, make sure that the unit is plugged in, but not turned on.

- Check that the rated voltage of the unit matches your local voltage.
1. When the AC power cord is plugged in, the clock display will blink.
  3. Press the **◀◀ / ▶▶** buttons to set the current hours then press the **SET CLOCK** button once to confirm. Then, the MINUTE blinks.

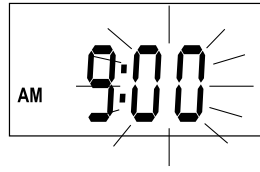
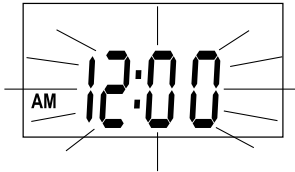

2. Press the **SET CLOCK** button until the HOUR blinks.
4. Press the **◀◀ / ▶▶** buttons to set the current minutes then press the **SET CLOCK** button once to start the clock.

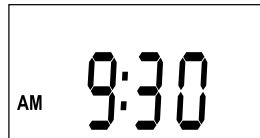
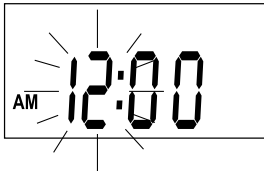

## SETTING THE COOKING TIMER

1. Press the **TIMER** button. The "TIMER" indicator appears and the cooking time "10" blinks.
3. When the preset time elapses, the ALARM will sound.

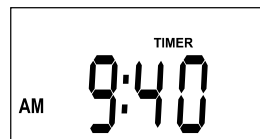
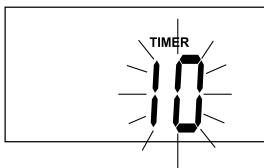

2. Press the **◀◀ / ▶▶** buttons to select your desired time from 1-99 minutes.
  - Press the **TIMER** button repeatedly to select time: 10, 15, 30, 45, 60, 75, 90 minutes.
  - Press and hold the **◀◀ / ▶▶** buttons to fast forward/reverse the cooking time.
4. To turn OFF the ALARM, press the **TIMER** button once. Otherwise, the ALARM will automatically turn off after 60 minutes if no button is pressed.



### CANCELLING THE COOKING TIMER

- Press the **TIMER** button until the time of the cooking timer shows "OFF". The "TIMER" indicator will disappear.





# PLAYING A DISC

This owner's manual explains the basic instructions of this unit. Some DVDs are produced in a manner that allows specific or limited operation during playback. Such as, the unit may not respond to all operating commands. This is not a defect in the unit. Refer to the instruction notes of discs.

"" may appear on the screen during operation. A "" means that the desired operation is not permitted by the unit or disc.

## Playing a Disc

1. Press the  **STANDBY/ON** button to turn on the unit.
2. Press the **DVD/TV/RADIO** button (the **FUNCTION** button on the remote) to select DVD mode.  
See **CUSTOMIZING THE FUNCTION SETTINGS** (page 22 to 23) before proceeding to step 3.

3. Press the  **OPEN/CLOSE** button. The disc tray opens.
4. Place a disc onto the disc tray with the label side up.
5. Press the  **OPEN/CLOSE** button. The disc tray closes.



It takes a short while for your unit to load the disc. After loading, the unit will automatically either bring you to the main menu of the DVD or start playback of the disc.

6. If the unit does not automatically start playing the DVD, press the  **PLAY** button.

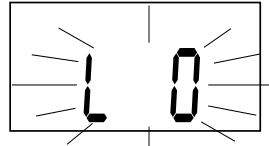

- When **MUTE** is pressed, the sound is mute and the "L O" indicator always blinks on the LCD display until **MUTE** is pressed again or **VOL** is pressed.





## Pausing Playback (Still Mode)



Press the  **PAUSE** button on the remote. To resume normal playback, press the  **PLAY** button. Each time you press the  **PAUSE** button, the picture advances one frame.

## Stopping Playback





Press the  **STOP** button at the location where you want to interrupt playback. To resume playback at the position where the disc was stopped, press the  **PLAY** button.

If you press the  **STOP** button twice, the unit's memory will be cleared and pressing the  **PLAY** button will reset the disc to the beginning.

## Skipping to a Different Chapter/Track

- Press the  button repeatedly to skip to the start of the current or previous chapter/track.
- Press the  button to skip to the next chapter/track.
- For an audio CD, use the number buttons (remote control only) to go directly to that track number.

## Fast Forward/Fast Reverse

1. Press the **TUNING ** or ** TUNING** button on the remote control when a disc is playing.
  - The disc begins fast scan at x2 speed.
  - Four speeds are available. Each time the **TUNING ** or ** TUNING** button is pressed, the speed of fast scan changes in the following sequence:

2. Press the  **PLAY** button when you have reached the desired point to resume playback at normal speed.

### Notes:

- The DVD player mutes sound during reverse and forward scan of DVD video discs.
- The fast playback speed may differ depending on the disc.

# PLAYING A DISC

## Angle Selection

Some DVDs contain scenes which have been shot from a number of different angles. For these discs, the same scene can be viewed from each of these different angles.

1. While you are playing a DVD with different angles recorded, press the **ANGLE** button to view the number of current angles available.
2. Press the **ANGLE** button repeatedly to change the scene to the next angle in those recorded.
  - About two seconds later, playback continues from the new angle selected.
  - If no button is pressed within 10 seconds, playback continues without changing the current angle.

Sequence of angle shots  
(Example)



### Notes:

- This function can only be used for discs on which scenes shot from multiple angles have been recorded.
- If only one angle is recorded, “  ” is displayed.

## Subtitle Selection

1. While a DVD is playing, press the **SUBTITLE** button to display the current language setting, as shown in the example below.
2. Press the **SUBTITLE** button repeatedly to select the desired subtitle language.

 1/3 Eng

### Notes:

- If only one language is recorded, the language does not change.
- About two seconds later, playback continues with the new subtitle selected.
- The number of languages recorded differs depending on the disc.
- If no button is pressed within a few seconds, playback continues without changing the current subtitle.
- This function can only be used for discs on which subtitles have been recorded in multiple languages.
- On some DVDs, subtitles are activated from the main menu of the DVD. Press the DVD MENU button to activate the main menu.

## Audio Selection

On some discs, the sound is recorded in two or more formats. Follow the directions below to select the type of playback.



1. While a disc is playing, press the **AUDIO** button to show the current audio format number.
2. Press the **AUDIO** button repeatedly to select the desired audio format.

 1/3  6 Ch Eng

### Notes:

- If only one audio format is recorded, the number does not change.
- Some DVD discs allow you to change audio selections only via the disc menu. If this is the case, press the DVD MENU button and choose the appropriate language on the disc menu.
- You can select different audio channels (Left, Right, Mix or Stereo) on an audio CD by pressing the AUDIO button repeatedly.

## Sound mode setting

You can press the **SOUND** button on the remote control to select a sound mode (  <Bass0>,  <Bass1> and  <Bass2>).

# PLAYING A DISC

## Display Function

While the disc is playing, press the DISPLAY button on the remote control repeatedly to display information on operation status.

**Time:** The elapsed time from the beginning of the title which is currently playing.

**Title/Chapter:** The number of the title/chapter currently playing and total titles/chapter on disc.

**Audio:** The type of the audio currently selected is displayed.

**Subtitle:** The subtitle number and language currently selected is displayed. When a disc with only one subtitle is played back, " 1/1 Eng" is displayed.

**Angle:** The current angle is displayed. When a disc with only one angle is played back, " 1/1" is displayed.



## SPECIAL FUNCTION

### Locating a Specific Title/Chapter/Time

If a DVD contains title/chapter/time numbers, you can locate a specific title/chapter/time by directly selecting a title/chapter/time number.

1. Press the **GOTO** button to display **Title**.
2. Press the **▲** or **▼** button on the remote to select the option (Title, Chapter or Time) then press the corresponding number button(s) for the Title/Chapter/Time you want.
3. Press the **ENTER** button to confirm. The unit will start playback about 3 seconds later.

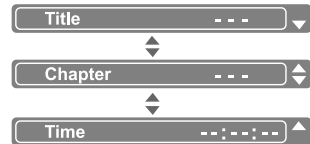

### Locating a Specific Track

If a CD contains track numbers, you can locate a specific track by directly selecting track number.

1. Press the **GOTO** button.
2. Press the **▲** or **▼** button on the remote to select the option (Track, Time or Disc Time) then press the corresponding number button(s) for the Track/Time/Disc time you want.
3. Press the **ENTER** button to confirm. The unit will start playback about 3 seconds later.

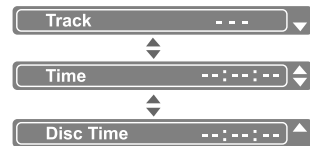

#### Notes:

- If the time numbers you entered is not permitted by the DVD, after you press the **ENTER** button, it will restore to "--:--:--". You should re-enter correct numbers.
- Some discs may not respond to this process.
- Some scenes may not be located as precisely as you specified.
- This method for accessing specific locations is available only within the current title of the DVD.

# SPECIAL FUNCTION

## Setting Favorite Bookmarks During Playback

While a disc is playing, you can mark the desired scene.

1. Press the **GOTO** button until **Bookmark1** appears.
2. Press the **ENTER** button to mark the desired scene and the time of this point will be shown in **Bookmark1**.
3. Press the **ENTER** button to play the favorite bookmark.

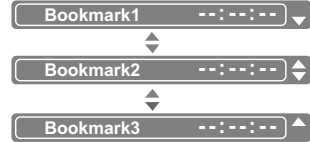

### To Set Other Bookmarks

1. Press the **GOTO** button until **Bookmark1** appears, then use the **▲** or **▼** button on the remote to select **Bookmark2/Bookmark3**.
2. Press the **ENTER** button.

Notes:

- Some discs may not work with marking operation.
- The marking is cancelled when you open the disc tray or turn the unit off.

# REPEAT PLAYBACK

You can play a specific title or chapter repeatedly.

## Repeating a Chapter

You can play the same chapter repeatedly.

1. While the disc is playing, press the **REPEAT DISC** button until the “Repeat Chapter” indicator displays on the screen. The current chapter is played repeatedly.

### Repeating a Title

You can play the same title repeatedly.

2. While the disc is playing, press the **REPEAT DISC** button until the “Repeat Title” indicator displays on the screen. The current title is played repeatedly.

### To Resume Normal Playback

3. While the disc is playing, press the **REPEAT DISC** button until the “Repeat Off” indicator displays on the screen.

You can play a single track or whole disc repeatedly.

## Repeating a Single Track

You can play the same track repeatedly.

1. While the disc is playing, press the **REPEAT DISC** button on the remote control until the “Repeat single” indicator displays on the screen. The current track is played repeatedly.

### Repeating a Whole Disc

2. While the disc is playing, press the **REPEAT DISC** button on the remote control until the “Repeat all” indicator displays on the screen. The whole disc is played repeatedly.

### To Resume Normal Playback

3. Press the **REPEAT DISC** button until the “Repeat off” indicator displays on the screen.

You can play a single track or the entire CD repeatedly through the Toolkit which appears on the right in the window.

While the disc is playing, use the **▶** and **▼** buttons on the remote to select “Repeat”, then press the **ENTER** button to select **Single/All/Off**.

**Single:** Repeat the current track.

**All:** Repeat the entire CD.

**Off:** Resume normal playback

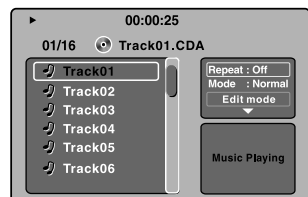

# DVD PROGRAMMABLE MEMORY

## DVD Programmed Playback

You can combine your favorite titles/chapters and play them in the order you determine.

1. Press the **MEMORY** button on the remote control.
2. Use the **▲** or **▼** button to select the title you want, then press the **ENTER** button on the remote control to confirm.
3. Use the **▲** or **▼** button to select the chapter you want, then press the **ENTER** button on the remote control.
4. Use the **▲** button to move the cursor to the top of the chapter list and press the **ENTER** button to return to **Title** window. Then repeat steps 2 to 3 to add additional titles and chapters.
5. Press the **▶ PLAY** button to start the programmed playback.

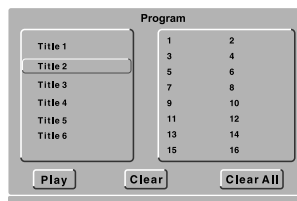

### To Change the Programmed Selections

- 1) Press the **MEMORY** button.
- 2) Press the **▶** button to select "Clear", then press the **ENTER** button to clear them one by one.
- 3) Follow above steps 1-4 of DVD Programmable Memory to program the new title and chapter.

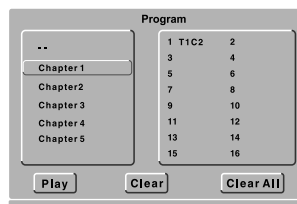

### To Resume Normal Playback from Programmed Playback

- 1) Press the **MEMORY** button.
- 2) Press the **▶** button to select "Clear All", then press the **ENTER** button. All the programs will be cleared.
- 3) Press the **▶ PLAY** button to resume normal playback.

### Notes:

- Some discs may not permit memory playback operation.
- To exit the Program menu, press the **MEMORY** button.
- The programmed selections will be cleared when you open the disc tray or turn off the DVD player.

## VIEWING JPEG FILES

This unit can play JPEG files recorded on a CD-R/RW discs.

### Viewing JPEG Files

1. Open the disc tray.
2. Place a disc onto the disc tray with the label side up.
3. Close the disc tray. A list of folders/files will appear on the screen.
4. Press the **▲** or **▼** button to select your desired file, the selected picture will appear in the lower right corner.
5. Press the **▶ PLAY** button to start playback. Press the **■ STOP** button to display a folder list.

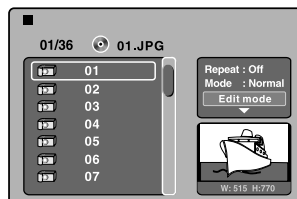

### Notes:

- You can press the **|| PAUSE** button to freeze the picture, and press the **▶ PLAY** button to resume slide show.
- You can press the **■ STOP** button to quit playback.
- You can use the number buttons on the remote control to jump immediately to the desired picture.
- You can press the **ANGLE** button on the remote control to rotate direction of the picture by 90°.
- Some discs may not permit this operation.

# PLAY MODES FOR CD OR JPEG DISC

When playing CD/JPEG discs, you can modify the Play Modes through the Toolkit which appears on the right in the window. Press the ◀ or ▶ button on the remote control to navigate between the left/right windows and the ▲ or ▼ button on the remote control to select files/tracks or play mode items. Then press the **ENTER** button.

## CD Track/JPEG File Programmed Playback

1. Use the ▶ and ▼ buttons on the remote to select "Edit mode" then press the **ENTER** button.
  2. Use the cursor buttons (◀, ▶, ▲, ▼) to select tracks/files shown on the left side of the window, then press the **ENTER** button. "✓" will appear in front of the selected tracks/files.
  3. Use the ▶ and ▼ buttons to select "Add to program", press the **ENTER** button. "✓" will disappear from the screen. It means that the tracks/files you selected have been added into the "Program view".
  4. Use the ▲ or ▼ button to select "Program view" and press the **ENTER** button to view programmed files.
  5. Press the ▶ **PLAY** button to start the program playback.
- Note: When programming the JPEG files, it should be in STOP mode.

## Clear the Programmed Tracks/Files

- Press the ■ **STOP** button twice to stop playback.
1. Use the ▶ and ▼ buttons on the remote to select "Edit mode" then press the **ENTER** button.
  2. Use the ▲ or ▼ button to select "Program view", then press the **ENTER** button. The programmed tracks/files appear on the left side of the window.
  3. Use the cursor buttons (◀, ▶, ▲, ▼) to select the programmed tracks/files, then press the **ENTER** button. "✓" will appear in front of the selected tracks/files.
  4. Use the ▶ and ▼ buttons to select "Clear program" then press the **ENTER** button.

Note: It is disabled if the "Edit mode" item is not selected.

The Toolkit has the following play mode items:

- **Repeat (Off/Single/All):**
  - Off:** Resumes normal playback.
  - Single:** Repeats the current track/file.
  - All:** Repeats all files on the current folder or all tracks on the disc.
- **Mode (Normal/Shuffle/Music Intro):**
  - Normal:** Resumes normal playback.
  - Shuffle:** Playbacks track/file in random order.
  - Music Intro:** Only playback the first 10 seconds of all tracks on the disc.
- **Edit mode:** Program operation works only when "Edit mode" is selected.
- **Program view:** To view tracks/files in the "Program view" list. It is disabled when the "Program view" list is empty.
- **Add to program:** Add files/tracks to the "Program view" list. It is disabled if the "Edit mode" item is not selected.
- **Browser view:** To view files/tracks in the original view list.
- **Clear program:** Delete the files/tracks in the "Program view" list.

**Note:** The program will be deleted if disc tray is opened.

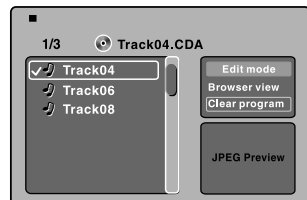
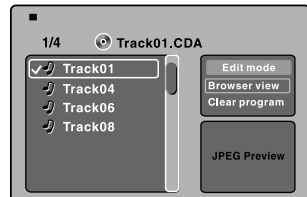
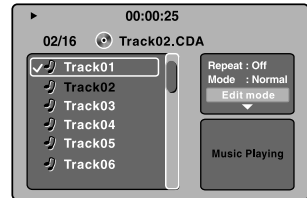

# CUSTOMIZING THE FUNCTION SETTINGS

## Language

### OSD Language

1. Press the **SETUP** button in stop mode.
2. Press the **▶** button to select **OSD Language**.
3. Press the **▶** button. Use the **▲** or **▼** button to make adjustments, then press the **ENTER** button.  
The screen will change to your selected language immediately.
4. Press the **EXIT** button to return to the normal screen.

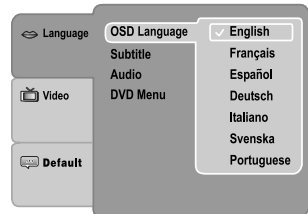

### Subtitle

1. Press the **SETUP** button in stop mode.
2. Press the **▶** button. Use the **▲** or **▼** button to select **Subtitle**.
3. Press the **▶** button. Use the **▲** or **▼** button to make adjustments, then press the **ENTER** button.
4. Press the **EXIT** button to return to the normal screen.

#### Notes:

- Some DVDs may be set to display subtitles in a different language other than the ones you selected. A prior subtitle language may be programmed on the disc.
- Some DVDs allow you to change subtitle selections via the disc menu only. If this is the case, press the DVD MENU button and choose the appropriate subtitle language from the selection on the disc menu.

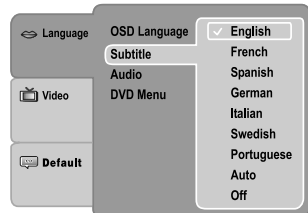

### Audio

1. Press the **SETUP** button in stop mode.
2. Press the **▶** button. Use the **▲** or **▼** button to select **Audio**.
3. Press the **▶** button. Use the **▲** or **▼** button to make adjustments, then press the **ENTER** button.
4. Press the **EXIT** button to return to the normal screen.

Note: Some DVDs may not play in the selected language. A prior language may be programmed on the disc.

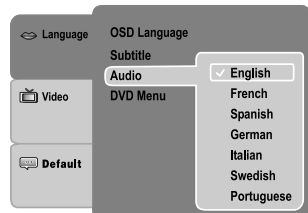

### DVD Menu

1. Press the **SETUP** button in stop mode.
2. Press the **▶** button. Use the **▲** or **▼** button to select **DVD Menu**.
3. Press the **▶** button. Use the **▲** or **▼** button to make adjustments, then press the **ENTER** button.
4. Press the **EXIT** button to return to the normal screen.

Note: Some DVDs may not include your pre-selected language. In this case, the DVD player automatically displays disc menus consistent with the disc's initial language setting.

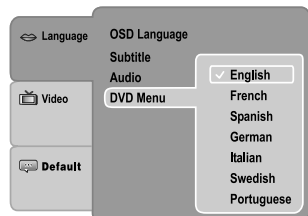

### Video

#### TV Shape

1. Press the **SETUP** button in stop mode.
2. Press the **▲** or **▼** button to select **VIDEO**.
3. Press the **▶** button. Use the **▲** or **▼** button to select **TV Shape**.
4. Press the **▶** button. Use the **▲** or **▼** button to make adjustments, then press the **ENTER** button.
5. Press the **EXIT** button to return to the normal screen.

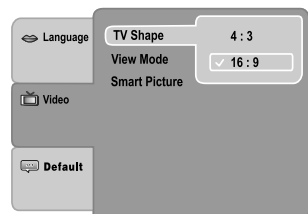

# CUSTOMIZING THE FUNCTION SETTINGS

## Notes:

- The displayable picture size is preset on the DVD. Therefore, the playback picture of some DVDs may not conform to the picture size you select.
- When you play DVDs recorded in the 4:3 picture size only, the playback picture always appears in the 4:3 picture size regardless of the TV Shape setting.
- Select 16:9 to conform the LCD screen on the unit. Always be sure that your TV Shape conforms to the actual TV in use if you connect the unit to a TV.

## View Mode

1. Press the **SETUP** button in stop mode.
2. Press the **▲** or **▼** button to select **VIDEO**.
3. Press the **▶** button. Use the **▲** or **▼** button to select **View Mode**.
4. Press the **▶** button. Use the **▲** or **▼** button to select the option (Fill, Original, Auto Fit or Pan Scan), then press the **ENTER** button.
5. Press the **EXIT** button to return to the normal screen.

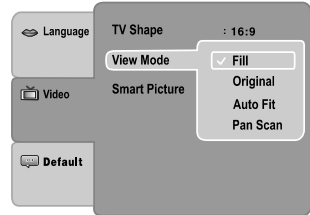

**Fill:** Fill the screen with decoded image.

**Original:** Display image as it's original size.

**Auto Fit:** Automatically fit the decoded image on screen without distortion. Black bars will be present on top/bottom or left/right of screen.

**Pan Scan:** Select when a standard 4:3 TV is connected. Displays pictures cropped to fill your TV screen. Sides of the picture are cut off.

Note: Depending on the DVDs, you may not be able to view the mode as selected.

## Smart Picture

1. Press the **SETUP** button in stop mode.
2. Press the **▲** or **▼** button to select **VIDEO**.
3. Press the **▶** button. Use the **▲** or **▼** button to select **Smart Picture**.
4. Press the **▶** button. Use the **▲** or **▼** button to select the option (Standard, Bright, Soft or Dynamic), then press the **ENTER** button.
5. Press the **EXIT** button to return to the normal screen.

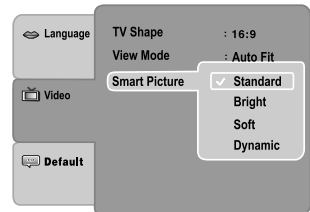

**Standard:** Picture is set to normal brightness.

**Bright:** Picture is brighter.

**Soft:** Softer image effect.

**Dynamic:** It includes 4 items (Brightness, Contrast, Tint and Color). Use the **◀** or **▶** button to make adjustments.

## Default

### Use Default Settings

1. Press the **SETUP** button in stop mode.
2. Press the **▲** or **▼** button to select **DEFAULT**.
3. Press the **▶** button, then press the **ENTER** button.
4. Use the **◀** or **▶** button to select "YES", then press the **ENTER** button. The original setting will be restored. The unit will exit setting menu automatically and reload the disc in the disc tray.

Note: It will take 3-5 seconds to reset the DVD player to the factory default.

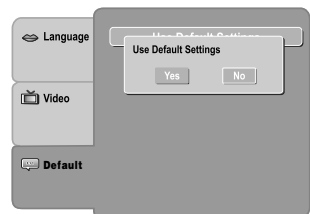



# USING THE TV

## Connect an antenna or CATV cable to the TV ANT. VHF/UHF terminal before searching TV channels.

1. Connect the TV antenna.
2. Connect the AC power cord.
3. Press the **STANDBY/ON** button to turn on the unit.
4. Press the **DVD/TV/RADIO** button (the **FUNCTION** button on the remote control) to select TV mode.

### Searching for TV channels Automatically

When this unit is connected to an antenna, or a cable or satellite system, it can automatically search all channels for those with adequate signal strength.

1. Press the **TV MENU** button on the remote control, then press the **▶** button to **TV SETTING**.
2. Press the **▼** button to select **TV TYPES**. Use the **◀** or **▶** button to select Air or CATV.
3. Use the **▲** button to select **Auto tune**, then press the **◀** or **▶** button to start the search for TV channels.
4. The screen will show the first received channel when auto search is completed.

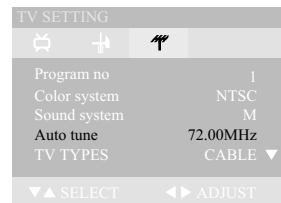
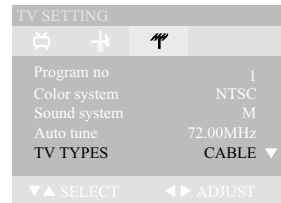

### Watching Television

Viewing a television station after the auto search for channels.

1. Press the **FUNCTION** button to TV mode.
2. Press the **▼ CH ▲** buttons (the **▲ CH+** or **▼ CH-** button on the remote control) to select a channel, or press the number button on the remote to select the channel you want to watch.
  - For channels 1 to 9, enter one-digit channel number.
  - For channels 10 to 99, enter the two-digit channel number.
  - For channels 100 or over, enter three-digit channel number.
  - You can set up 2 - 69 channels in AIR mode, 1 - 125 channels in CABLE mode.

Notes:

- When a channel is selected, the channel number is displayed on the top right corner of the screen. This number will disappear after a few seconds.
- When **MUTE** is pressed, the sound is mute and the "L O" indicator always blinks on the LCD display until **MUTE** is pressed again or **VOL** is pressed.

### Sound mode setting

You can press the **SOUND** button on the remote control to select a sound mode ( **BAR0** <Bass0>, **BAR1** <Bass1> and **BAR2** <Bass2>).

# TV MENU

## PICTURE Setting

1. Press the **TV MENU** button.
2. Use the **▲** or **▼** button to select the options (**Brightness / Contrast / Color / Tint**).
3. Use the **◀** or **▶** button to make adjustment. The screen will change to your selected mode immediately.
4. Repeat steps 2 and 3 to adjust other options.
5. Press the **EXIT** button on the remote control to return to the normal screen.

**Brightness:** Adjust to brighten or darken the whole picture.

**Contrast:** Adjust to sharpen the picture quality. The black portions of the picture become richer in darkness and the white become brighter.

**Color:** Adjust the colour of the picture.

**Tint:** Adjust the tint of the picture (Toward purple/Toward green).

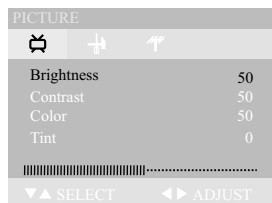

## Picture mode setting

You can press the **PICTURE** button on the remote control to select a picture mode to match the type of show you are watching. (**Personal, Movie, Standard, Soft and Dynamic**).

## SETUP

1. Press the **TV MENU** button.
2. Use the **◀** or **▶** button to select **SETUP**.
3. Use the **▲** or **▼** button to select the options (**Language / Restore setting**).
4. Use the **◀** or **▶** button to make adjustment. The screen will change to your selected mode immediately.
5. Repeat steps 2 and 3 to adjust other options.
6. Press the **EXIT** button on the remote control to return to the normal screen.

**Language :** Select the language your prefer (English / Français / Español).

**Restore Setting:** If you reset the TV to the factory settings, all your present settings on picture will be erased and replaced by the factory's default settings.

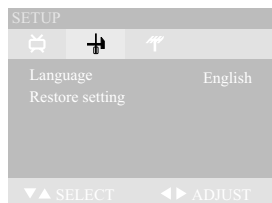

# TV MENU

## TV SETTING

1. Press the **TV MENU** button.
2. Use the ◀ or ▶ button to select **TV SETTING**.
3. Use the ▲ or ▼ button to select the options (**Program no / Color system / Sound system / Auto tune / TV TYPES / AFC / Skip**).
4. Use the ◀ or ▶ button to make adjustment.
5. Repeat steps 2 and 3 to adjust other options.
6. Press the **EXIT** button on the remote control to return to the normal screen.

**Program no:** To select a TV channel by pressing the ◀ or ▶ button.

**Color system:** **NTSC** mode is default.

**Sound system:** **M** mode is default.

**Auto tune:** Searches for usable stations and stores them in memory.

**TV TYPES:** **CABLE** mode (cable/satellite broadcasts, channels 1-125) and **AIR** mode (over-the air broadcasts, channels 2-69) are available.

**AFC:** Auto frequency control.

**Skip:** On - Skip weak channels.  
Off - No channel skip.

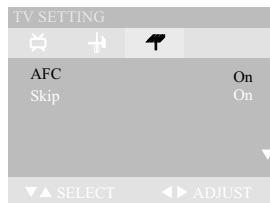
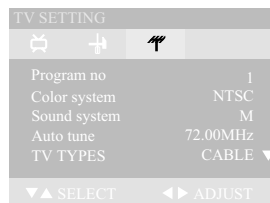

# LISTENING TO THE RADIO

## **Tuning in to a Station Manually**

1. Press the **DVD/TV/RADIO** button (the **FUNCTION** button on the remote) until the radio frequency appears on the front panel display.
  2. Press the **■ STOP / BAND** button to select AM or FM.
  3. Press the **◀ TUNING ▶** buttons on the remote to tune in to a desired station.
- When **MUTE** is pressed, the sound is mute and the “L O” indicator always blinks on the LCD display until **MUTE** is pressed again or **VOL** is pressed.

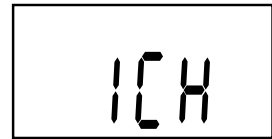
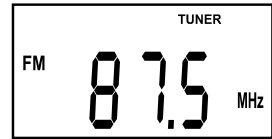

## **FM Stereo**

Press the **MTS** button on the remote until “56” appears on the front panel display.

## **Weak FM Stations**

Press the **MTS** button on the remote until “104” appears on the front panel display. Background noise will be reduced. To restore stereo reception, press the **MTS** button on the remote to select “56”.

## **Searching for a Station Automatically**

- Press and hold the **◀▶** button on the front panel or the **◀ TUNING ▶** buttons on the remote until the tuner starts searching for a station, then release. After tuning in a station, the search stops.
- The search may not stop at a station with a very weak signal.

## **Presetting Stations**

The unit can store a total of 60 stations in memory (30 FM, 30 AM). Presetting allows you to tune in to a station directly.

1. Press the **DVD/TV/RADIO** button (the **FUNCTION** button on the remote) to **RADIO**.
2. Press the **■ STOP / BAND** button to select AM or FM.
3. Press the number button on the remote to select the preset number.
  - For preset numbers 1 to 9 simply press the number button on the remote.
  - For preset numbers 10 to 30, enter the two-digit numbers.  
For example, to enter 18 by pressing “1” & “8”.
4. Press the **◀ TUNING ▶** buttons to tune in to a desired station.
5. Press the **MEMORY** button twice on the remote.
6. Repeat steps 2-5 to store other stations.

## **Tuning in to a Preset Station**

1. Press the **DVD/TV/RADIO** button (the **FUNCTION** button on the remote) to **RADIO**.
2. Press the **■ STOP / BAND** button to select AM or FM.
3. Press the **◀▶** button repeatedly to select the number of the preset station or use the numbered buttons to enter the number of the preset station.

## **For Better Reception**

**FM:** Fully unwind the FM antenna wire. Then extend the FM antenna wire and place it in the position that sounds best.

**Note:** Do not connect the FM antenna to an outside antenna.

# TROUBLESHOOTING GUIDE

## SYMPTOM

## CAUSE (AND REMEDY)

No power.

- Ensure the AC power cord is connected.
- The unit is not turned on.

The remote does not function.

- Remove any obstacles between the remote and the unit.
- Use the remote near the unit.
- Point the remote at the remote sensor on the unit.
- Replace all batteries in the remote with new ones.

### DVD

No sound or only a very low-level sound is heard.

- Make sure that you've selected DVD mode.
- The system is in pause mode. Press the ►PLAY button to return to normal play mode.
- Fast forward or fast reverse is performed. Press the ►PLAY button to return to normal play mode.
- The DTS DVD cannot be decoded to have speaker output.
- This unit is too hot. Shut off the unit for 30 minutes to allow it to cool down.

No picture

- The region number of the disc doesn't match the region number of this unit.



The picture is not clear

- Clean the disc.
- The disc is scratched.

Severe hum or noise is heard.

- Clean the disc.

The disc does not play.

- There is no disc inside ("No Disc" appears on the screen).
- Insert the disc correctly with the label side facing up on the disc tray.
- Clean the disc.
- A non-NTSC disc has been inserted. The unit and disc region number are incompatible.
- Condensation may have formed inside the unit due to a sudden change in temperature. Wait about an hour for it to clear and try again.

### TV

Snowy picture, multiple image, picture distorted, picture blurred and noisy sound.

- Check antenna location, direction or connection.

No color of picture.

- Check the PICTURE SETTING in the TV SETUP MENU.

No picture and sound.

- Not plugged into AC outlet.
- Make sure that you've selected TV mode.
- Try a new channel to check for possible station trouble.
- Make sure the antenna is connected to properly.
- Increase the volume.
- The antenna is broken.
- Check for local interference.

Colored patches of picture.

- Magnetic interference from unshielded equipment.
- Turn OFF the unit for 30 minutes, then turn ON again.

# MAINTENANCE

## ***Cleaning the Disc***

A defective or soiled disc inserted into the unit can cause sound to drop out during playback. Handle the disc by holding its inner and outer edges.

- Do NOT touch the surface of the unlabeled side of the disc.
- Do NOT stick paper or tape on the surface.
- Do NOT expose the disc to direct sunlight or excessive heat.
- Clean the disc before playback. Wipe the disc from the center outward with a cleaning cloth.
- NEVER use solvents such as benzine or alcohol to clean the disc.
- Do NOT use irregular shaped discs (example: heart shaped, octagonal, etc.). They may cause malfunctions.

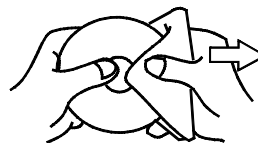

## ***Cleaning the Unit***

Clean plastic cover over screen if it becomes dirty with oil, grease, dust, etc while cooking. Please follow below steps.

- Be sure to turn the unit off and disconnect the AC power cord before cleaning the unit.
- Wipe the unit with a dry soft cloth. If the surfaces are extremely dirty, wipe clean with a cloth which has been dipped in a weak soap-and-water solution and wrung out thoroughly. Then wipe with a dry cloth.
- Never use alcohol, benzine, thinner, cleaning fluid or other chemicals. Do NOT use compressed air to remove dust.

## ***Important Note***

Before transporting the unit, remove the disc from the disc compartment.

# SPECIFICATIONS

Power source: AC 120V ~ 60Hz

Specifications and external appearance are subject to change without notice.

# LIMITED WARRANTY

**VENTURER ELECTRONICS ("VENTURER")** makes the following limited warranty. This limited warranty extend to the original consumer purchaser and is limited to non-commercial use of the product.

## One Year Parts & Labor Warranty

**VENTURER** products purchased in the United States are warranted to be free from defects in materials or workmanship for a period of one year from the date of their original retail purchase. If the unit fails to conform to this warranty, we will service the product using new or refurbished parts and products, at **VENTURER's** sole discretion.

During a period of one year from the effective warranty date, **VENTURER** will provide, when needed, service labor to repair a manufacturing defect at its designated Service Center. To obtain warranty service in the United States, you must first call our **Customer Support Center at (800) 252-6123, during the hours listed in the box below.** The determination of service will be made by **VENTURER** Customer Support. **PLEASE DO NOT RETURN YOUR UNIT TO VENTURER WITHOUT PRIOR AUTHORIZATION.** New or remanufactured replacements for defective parts or products will be used for repairs by **VENTURER** at its designated Service Center for one year from the effective warranty date. Such replacement parts or products are warranted for an additional one year from the date of repair or replacement. The Customer will be required to ship the unit to the Service Center indicated at the time Customer Support is contacted to make the necessary repairs. The customer is responsible for all transportation charges to the service facility.

## Packaging and Shipping Instruction

When you send the product to the **VENTURER** service facility you must use the original carton box and packing material or an equivalent as designated by **VENTURER.**

# LIMITED WARRANTY

## Your Responsibility

- (1) You must retain the original sale receipt to provide proof of purchase.
- (2) These warranties are effective only if the product is purchased and operated in the U.S.A. or Canada.
- (3) Warranties extend only to defects in material or workmanship, and do not extend to any product or parts which have been lost or discarded, or damage to product or parts caused by misuse, accident, improper operation or maintenance, or use in violation of instructions provided with the product, or to product which has been altered or modified without authorization of **VENTURER,** or to products or parts thereof which have had the serial number removed or changed.

## Out of Warranty

In the event your product requires repair after the limited warranty period has expired, please contact our Customer Support Center at **1-800-252-6123 or [www.venturer.com](http://www.venturer.com).**

**Hours: Monday–Thursday: 9–7, Friday: 9–5, Saturday: 9–12 EST.**

### Important:

You are responsible for any transportation, shipping or insurance relative to the return of product to our Product Returns Center.

# LIMITED WARRANTY

All warranties implied by state law, including the implied warranties of merchantability and fitness for a particular purpose, are expressly limited to the duration of the limited warranties set forth above. With the exception of any warranties implied by state law as hereby limited, the foregoing warranty is exclusive and in lieu of all other warranties, guarantees, agreements and similar obligations of manufacturer or seller with respect to the repair or replacement of any parts. In no event shall **VENTURER** be liable for consequential or incidental damages.

No person, agent, distributor, dealer or company is authorized to change, modify or extend the terms of these warranties in any manner whatsoever. The time within action must be commenced to enforce any obligation of **VENTURER** arising under the warranty or under any statute, or law of the United States or any state thereof, is hereby limited to one year from the date of purchase. This limitation does not apply to implied warranties arising under state law.

This warranty gives you specific legal rights and you may also have other rights, which may vary, from state to state. Some states do not allow limitation on how long an implied warranty lasts, when an action may be brought, or the exclusion or limitation of incidental or consequential damages, so the above provisions may not apply to you.

For more information on other products and services, please visit our web site at [www.venturer.com](http://www.venturer.com)

**Important:** Also keep your "Bill of Sale" as proof of purchase.

Model no. ....	Product name .....
Type of set .....	
Serial no. ....	Invoice no. ....
Date purchased .....	Dealer name .....

FOR SERVICE AND REPAIR, PLEASE VISIT [www.venturer.com](http://www.venturer.com)



## Free Manuals Download Website

<http://myh66.com>

<http://usermanuals.us>

<http://www.somanuals.com>

<http://www.4manuals.cc>

<http://www.manual-lib.com>

<http://www.404manual.com>

<http://www.luxmanual.com>

<http://aubethermostatmanual.com>

Golf course search by state

<http://golfingnear.com>

Email search by domain

<http://emailbydomain.com>

Auto manuals search

<http://auto.somanuals.com>

TV manuals search

<http://tv.somanuals.com>