

Digital Photo Frame

Operating Instructions

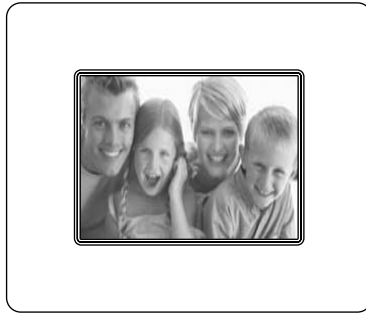

Need More Help?

DO NOT RETURN THIS PRODUCT TO THE STORE
Please visit online help at <http://www.1800customersupport.com>

SAFETY PRECAUTIONS



CAUTION: TO REDUCE THE RISK OF ELECTRIC SHOCK, DO NOT REMOVE COVER (OR BACK). NO USER-SERVICEABLE PARTS INSIDE. REFER SERVICING TO QUALIFIED SERVICE PERSONNEL.

The lightning flash with an arrowhead symbol, within the equilateral triangle, is intended to alert the user to the presence of uninsulated "dangerous voltage" within the product's enclosure that may be of sufficient magnitude to cause an electric shock.

The exclamation point within the equilateral triangle is intended to alert the user to the presence of important operating and maintenance (servicing) instructions in this owner's manual.

WARNING
TO PREVENT FIRE OR SHOCK HAZARD, DO NOT EXPOSE THIS APPLIANCE TO RAIN OR MOISTURE. DO NOT PLACE OBJECTS FILLED WITH LIQUIDS ON OR NEAR THIS UNIT.

On Placement

- Do not use the unit in places that are extremely hot, cold, dusty or humid.
- Do not restrict the airflow of the unit by placing it in a place with poor airflow, by covering it with a cloth, or by placing it on carpeting.
- Keep the stand of the unit clear from cables. Cables could pull the unit to the floor.
- The unit should not be exposed to excessive heat such as sunshine, fire or the like.

On Safety

- When connecting or disconnecting the AC power adapter, grip the plug and not the cord itself. Pulling the cord may damage it and create a hazard.
- When you are not going to use the unit for a long period, disconnect the AC power adapter.

Temperature and Humidity Limitations

- Operating temperature: 41°F ~ 95°F (5°C ~ 35°C)
- Humidity: 20% ~ 80%

Rating Plate Location

- The rating plate is located on the back of the unit.

WARNING: Should any trouble occur, disconnect the AC power adapter and refer servicing to a qualified technician.

Turn off the unit before inserting or removing the memory card. Do NOT insert or remove the memory card when the unit is playing files.

IMPORTANT SAFETY INSTRUCTIONS

- Read these instructions.
- Keep these instructions.
- Heed all warnings.
- Follow all instructions.
- Do not use this apparatus near water.
- Clean only with a dry cloth.
- Do not block any of the ventilation openings. Install in accordance with the manufacturer's instructions.
- Do not install near any heat sources such as radiators, heat registers, stoves, or other apparatus (including amplifiers) that produce heat.
- Do not defeat the safety purpose of the polarized or grounding-type plug. A polarized plug has two blades with one wider than the other. A grounding type plug has two blades and a third grounding prong. The wide blade or the third prong is provided for your safety. When the provided plug does not fit into your outlet, consult an electrician for replacement of the obsolete outlet.
- Protect the power cord from being walked on or pinched particularly at plugs, convenience receptacles, and the point where they exit from the apparatus.
- Only use attachments/accessories specified by the manufacturer.
- Use only with a cart, stand, tripod, bracket, or table specified by the manufacturer, or sold with the apparatus. When a cart is used, use caution when moving the cart/apparatus combination to avoid injury from tip-over.  **Portable Cart Warning**
- Unplug this apparatus during lightning storms or when unused for long periods.
- Refer all servicing to qualified service personnel. Servicing is required when the apparatus has been damaged in any way, such as the power-supply cord or plug is damaged, liquid has spilled or objects have fallen into the apparatus, the apparatus has been exposed to rain or moisture, does not operate normally, or has been dropped.

FCC Statements

This device complies with the Part 15 of the FCC rules. Operation is subject to the following two conditions:

- This device may not cause harmful interference, and
- This device must accept any interference received, including interference that may cause undesirable operation.

NOTE: This equipment has been tested and found to comply with the limits for a Class B digital device, pursuant to Part 15 of the FCC Rules. These limits are designed to provide reasonable protection against harmful interference in a residential installation. This equipment generates, uses and can radiate radio frequency energy and, if not installed and used in accordance with the instructions, may cause harmful interference to radio communications.

However, there is no guarantee that interference will not occur in a particular installation. If this equipment does cause harmful interference to radio or television reception, which can be determined by turning the equipment off and on, the user is encouraged to try to correct the interference by one or more of the following measures:

- Reorient or relocate the receiving antenna.
- Increase the separation between the equipment and receiver.
- Connect the equipment into an AC power outlet on a circuit different from that to which the receiver is connected.
- Consult the dealer or an experienced radio/TV technician for help.

Warning: Changes or modifications to this unit not expressly approved by the party responsible for compliance could void the user's authority to operate the equipment.

THIS CLASS B DIGITAL APPARATUS COMPLIES WITH CANADIAN ICES-003.

QUICK START GUIDE

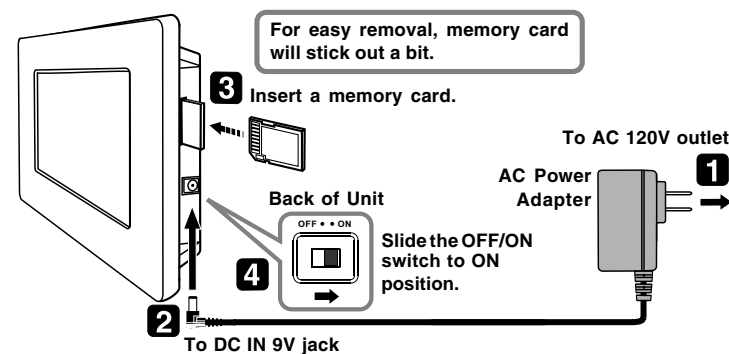

ACCESSORIES

Please check and identify the supplied accessories.

- To order accessories visit web site (<http://www.1800customersupport.com>)

- AC Power Adapter x 1
- Stand x 1

CONTROL REFERENCE GUIDE

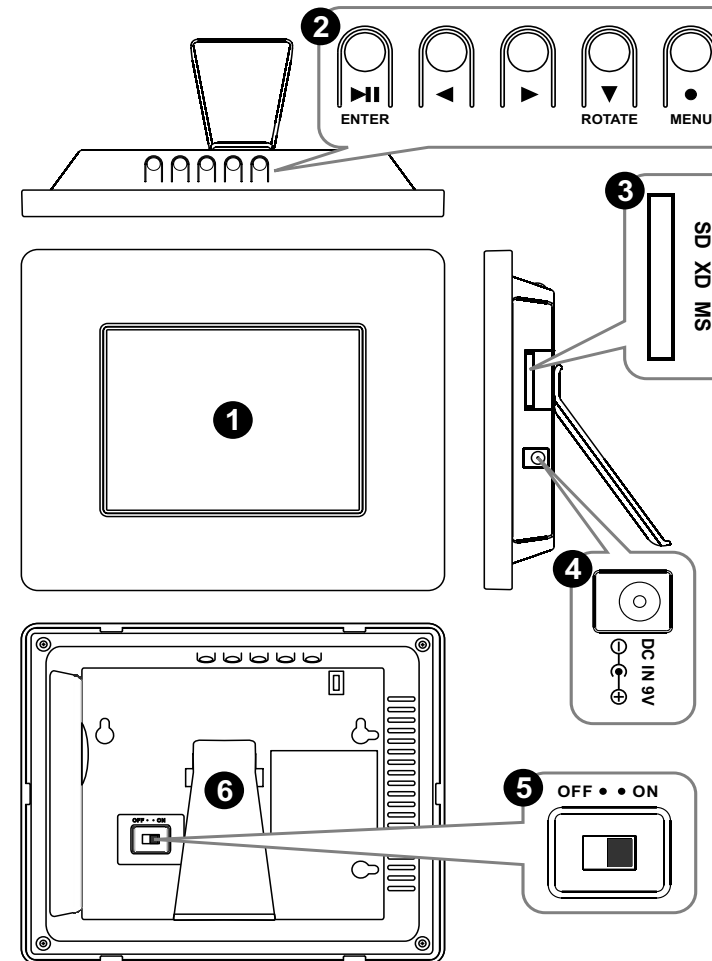

- LCD Screen
- Function Buttons

▶▶ Button
Press to start, pause and resume photo slide show playback. Press and hold to display the thumbnail menu. Use the ◀, ▶, ▼ buttons to select a photo, press the ▶▶ button to start playback.

ENTER Button
Confirm settings in the Setup Menu.

◀, ▶, ▼ Buttons
Move between selections on the Setup Menu screen.

◀ : Skip to the previous photo.

▶ : Skip to the next photo.

ROTATE Button

Rotate the photo by 90°.

Press and hold the **ROTATE** button to change the display aspect ratio (Fit Screen or Return to normal).

MENU Button

Enter and exit the Setup Menu.

- SD / xD / MS Card Slot
- DC IN 9V Jack
- OFF / ON Switch
- Removeable Stand

INSTALLATION

Using the Stand

The unit can be placed either horizontally or vertically to fit the photos on display by its stand.

- Slide the stand into the slots on the back of the unit as illustrated.
- Place the unit horizontally or vertically.

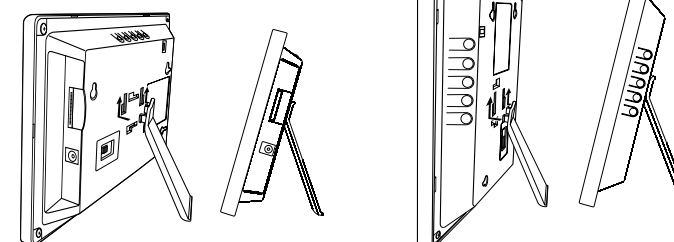

Mounting on the Wall

The unit can be mounted either horizontally or vertically on the wall by the mounting holes on the back of the unit.

Caution:

- Mounting the unit requires special skills that should only be performed by qualified personnel.
- Make sure that the wall mount is being fixed securely enough so that it meets safety standards.

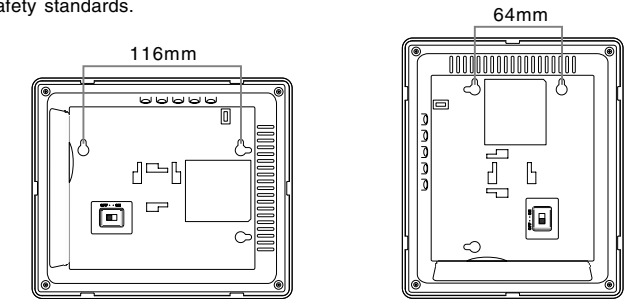

POWER SUPPLY

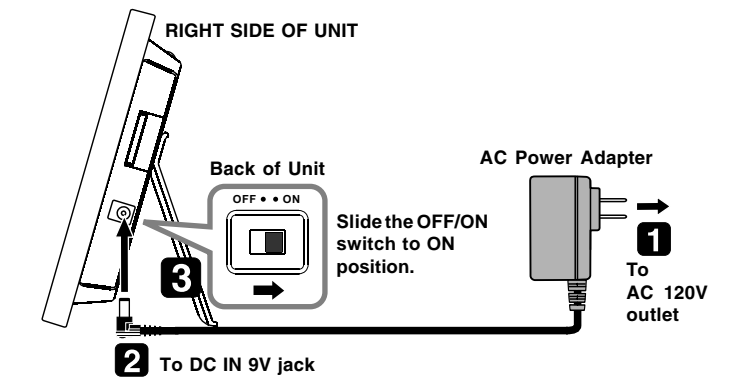

Caution:

- The AC power adapter included with this unit is for its use only. Do not use it with other equipment.
- Turn off the unit before unplugging the AC power adapter from the unit to avoid the unit being damaged.
- When the unit is not going to be used for a long time, disconnect the AC power adapter from the AC power outlet.

Important:

- Be sure to use it near the wall outlet. If a malfunction occurs, disconnect the plug from the wall outlet at once.
- When the AC power adapter is plugged in, the apparatus is not completely disconnected from the main power source, even when the unit is turned off.

Warning:

The AC power adapter is used as the disconnect device. To completely disconnect the apparatus from the main power supply, the AC power adapter should be disconnected from the AC power outlet completely.

INSERTING MEMORY CARD

Turn off the unit before inserting or removing the memory card. Do NOT insert or remove the memory card when the unit is playing files.

The unit is compatible with the following Memory Card:

- Secure Digital Card (SD)
- Memory Stick Pro (MS Pro)
- Extreme Digital (xD)

Insert any compatible memory card with the front label facing the rear of the product. Do not force the memory card into the memory card slot.

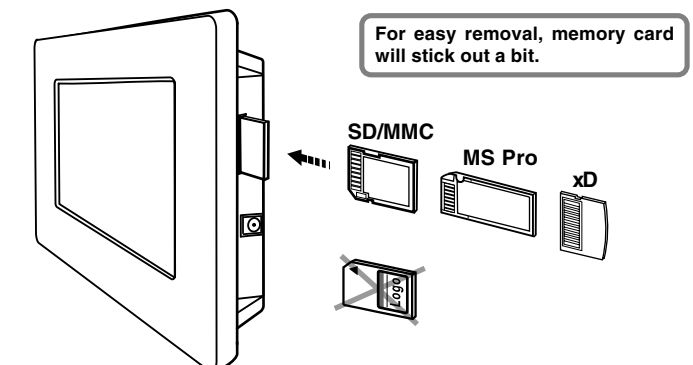

Note:

- If you cannot easily insert the memory card, you may have inserted it incorrectly. Try to turnover the card and then insert again.

VIEWING PHOTOS

1. Insert a SD, xD or MS Pro card into the card slot on the right side of the unit.
2. Slide the **OFF / ON** switch on the back of the unit to ON position, the unit will start loading and playing the photos stored on the memory card one by one.

• Press the **▶II** button to pause the playback. ("II") appears on the screen.)

• Press the **▶II** button again to resume playback. ("▶") appears on the screen.)

• Press and hold the **▶II** button to display the thumbnail menu.

In thumbnail mode, use the **◀▶**, **▼** buttons to select a photo, press the **▶II** button to start playback.

- Press the **◀▶** button to skip to the previous/next photo. ("◀▶" or "▶▶") appears on the screen.)
- Press the **ROTATE** button to rotate the photo by 90°.
- Press and hold the **ROTATE** button to change the display aspect ratio (Fit Screen or Return to normal).
- Press the **MENU** button to exit photo playback and enter the Setup Menu.

Note: Memory card should only contain Photo files in .jpg format.

PHOTO VIEWING SETUP MENU

1. Press the **MENU** button to enter Setup Menu.
2. In the Setup Menu, use the **◀▶**, **▼** and **ENTER** buttons to adjust the settings.

- Press the **▶** button to enter menu or setting.
 - Press the **▼** button to select a menu item or setting item.
 - Press the **◀** button to return to the previous menu.
 - Press the **ENTER** button to confirm setting.
3. Press **MENU** button to exit the Setup Menu.

Photo Setting

Interval Time (Slide Show Speed)

This option allows you to choose the time each photo will be displayed during slide show play.

You are able to set the interval time to: 15 Sec., 30 Sec., 60 Sec., Off, 05 Sec. or 10 Sec.

- Off: to disable slide show play. You can press the **◀▶** button to skip to the previous/next photo.

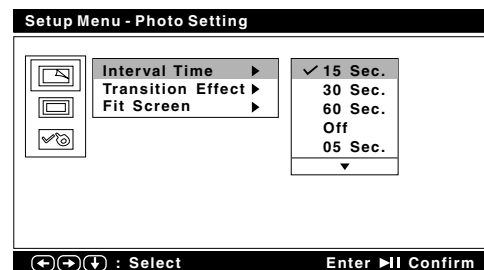

Transition Effect

This option allows you to choose the animation effect: All Effect, No Effect, Blind Vertical, Blind Horizontal, Color Ration Ver, Fade In Fade Out, Random.

- All Effect: to use all available animation effects.
- No Effect: to disable animation effect.

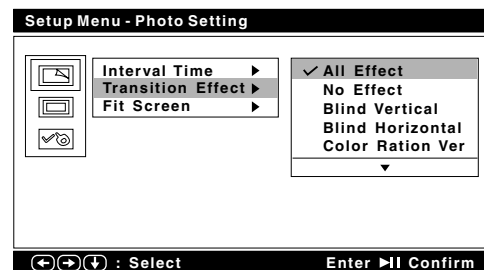

Fit Screen

This option allows you to choose how your photos fit on the display.

- Off: to display photos in its original aspect ratio.
- On: to display photos in full screen automatically.
- You can also press and hold the **ROTATE** button to turn Fit Screen on and off.

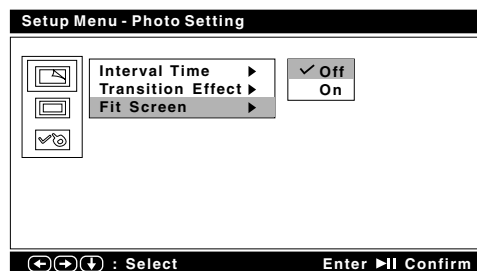

Display Setup

Brightness

Adjust the brightness of the LCD screen.

The following settings are available: 0, +1, +2, +3, +4, -1, -2, -3, -4.

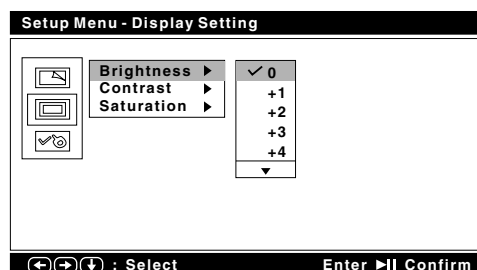

Contrast

Adjust the contrast of the LCD screen.

The following settings are available: 0, +1, +2, +3, +4, -1, -2, -3, -4.

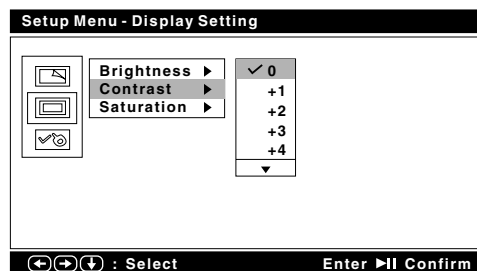

Saturation

Adjust the saturation of the LCD screen.

The following settings are available: 0, +1, +2, +3, +4, -1, -2, -3, -4.

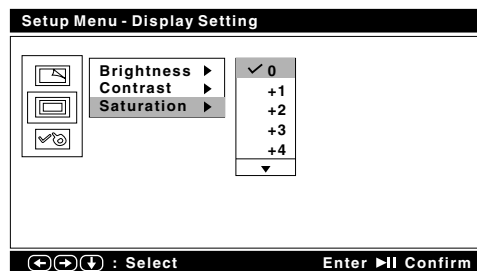

Custom Setup

Language

Choose your preferred On Screen Display language.

You are able to set the language to: English, Spanish, French, German or Italian.

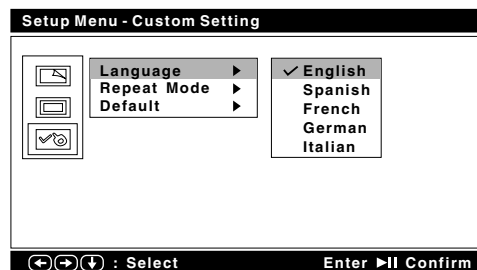

Repeat Mode

Choose your preferred repeat mode.

The following settings are available: Off, One or All.

- All: to play all photos repeatedly.
- One: to play the current photo repeatedly.
- Off: to play all photos one time, then return to thumbnail menu.

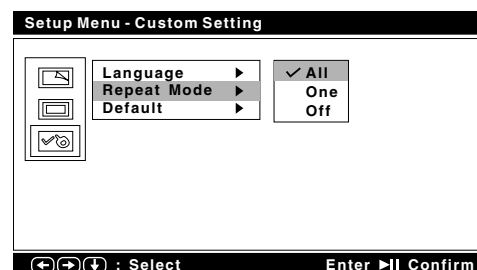

Default

Reset all the settings to the factory default.

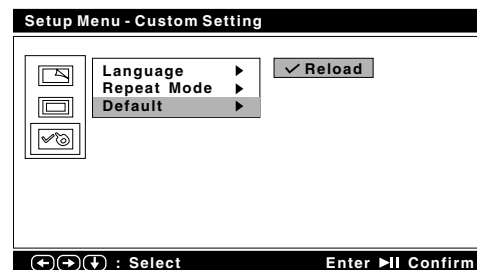

TROUBLESHOOTING GUIDE

SYMPTOM CAUSE (AND REMEDY)

SYMPTOM	CAUSE (AND REMEDY)
Screen freezes.	• Turn off the unit and unplug the AC power adapter, then reinsert the AC power adapter and turn on the unit again.
No power.	• Ensure that the AC power adapter is connected correctly.
Cannot read the memory card.	• Ensure the memory card is not damaged. • Ensure the photos are under the root directory of the memory card. • Ensure the memory card is inserted to the unit correctly. • Pull out the memory card and insert it again.
Cannot play photos.	• Ensure there are photos stored in the memory card. • The size of the photo is too large. Photo file size should not exceed 2MB.
Photo display is not correct.	• Press and hold the ROTATE button to adjust the screen aspect ratio. Many digital cameras take photos in 4:3 aspect ratio but some in 16:9 aspect ratio. Select a proper screen aspect ratio to view your photo.

MAINTENANCE

Cleaning the Unit

- Be sure to turn off the unit, disconnect the power adapter and remove the memory card before cleaning the unit.
- Wipe the unit with a dry soft cloth. If the surfaces are extremely dirty, wipe clean with a cloth that has been dipped in a weak soap-and-water solution and wrung out thoroughly, then wipe with a dry cloth.
- Never use alcohol, benzene, thinner, cleaning fluid or other chemicals. Do NOT use compressed air to remove dust.

Cleaning the LCD Screen

- Be sure to turn off the unit, disconnect the power adapter and remove the memory card before cleaning the LCD screen.
- Take good care of the LCD screen. The LCD screen is made of glass and is sensitive to abnormal force or hardware with sharp edges.
- If fingerprints or dust accumulate on the LCD screen, use a soft, non-abrasive cloth (such as a camera lens cloth) to clean the LCD screen.
- If the LCD screen is extremely dirty, and you want to use the LCD Cleaning Kit sold at various retail outlets, do NOT apply the cleaning liquid directly to the LCD screen. Moisten the cleaning cloth with the cleaning solution and wring out thoroughly, then clean the LCD screen, and wipe with a dry cloth again.

Specifications and external appearance are subject to change without notice.

LIMITED WARRANTY

VENTURER ELECTRONICS ("VENTURER") makes the following limited warranty. This limited warranty extends to the original consumer purchaser and is limited to non-commercial use of the product.

Ninety (90) Day Parts & Labor Warranty

VENTURER products purchased in the United States are warranted to be free from defects in materials or workmanship for a period of ninety (90) days from the date of their original retail purchase. If the unit fails to conform to this warranty, we will service the product using new or refurbished parts and products, at **VENTURER's** sole discretion.

During a period of ninety (90) days from the effective warranty date, Alco will provide, when needed, service labor to repair a manufacturing defect at its designated Service Center. To obtain warranty service in the United States, you must first call our **Customer Support Center at (800) 252-6123, during the hours listed in the box below.** The determination of service will be made by **VENTURER** Customer Support. **PLEASE DO NOT RETURN YOUR UNIT TO VENTURER WITHOUT PRIOR AUTHORIZATION.** New or remanufactured replacements for defective parts or products will be used for repairs by Alco at its designated Service Center for ninety (90) days from the effective warranty date. Such replacement parts or products are warranted for an additional ninety (90) days from the date of repair or replacement. The Customer will be required to ship the unit to the Service Center indicated at the time Customer Support is contacted to make the necessary repairs. The customer is responsible for all transportation charges to the service facility.

Packaging and Shipping Instruction

When you send the product to the Alco service facility you must use the original carton box and packing material or an equivalent as designated by **VENTURER.**

LIMITED WARRANTY

Your Responsibility

- (1) You must retain the original sales receipt to provide proof of purchase.
- (2) These warranties are effective only if the product is purchased and operated in the U.S.A. or Canada.
- (3) Warranties extend only to defects in material or workmanship, and do not extend to any product or parts which have been lost or discarded, or damage to product or parts caused by misuse, accident, improper operation or maintenance, or use in violation of instructions provided with the product, or to product which has been altered or modified without authorization of **VENTURER**, or to products or parts thereof which have had the serial number removed or changed.

Out of Warranty

In the event your product requires repair after the limited warranty period has expired, please contact our Customer Support Center at **1-800-252-6123** or **www.1800customersupport.com**.
Hours: Monday-Thursday: 9-7, Friday: 9-5, Saturday: 9-12 EST.
Important:
 You are responsible for any transportation, shipping or insurance relative to the return of product to our Product Returns Center.

All warranties implied by state law, including the implied warranties of merchantability and fitness for a particular purpose, are expressly limited to the duration of the limited warranties set forth above. With the exception of any warranties implied by state law as hereby limited, the foregoing warranty is exclusive and in lieu of all other warranties, guarantees, agreements and similar obligations of manufacturer or seller with respect to the repair or replacement of any parts. In no event shall **VENTURER** be liable for consequential or incidental damages.

No person, agent, distributor, dealer or company is authorized to change, modify or extend the terms of these warranties in any manner whatsoever. The time within action must be commenced to enforce any obligation of **VENTURER** arising under the warranty or under any statute, or law of the United States or any state thereof, is hereby limited to ninety (90) days from the date of purchase. This limitation does not apply to implied warranties arising under state law.

This warranty gives you specific legal rights and you may also have other rights, which may vary, from state to state. Some states do not allow limitation on how long an implied warranty lasts, when an action may be brought, or the exclusion or limitation of incidental or consequential damages, so the above provisions may not apply to you.

For more information on other products and services, please visit our web site at **www.1800customersupport.com**

Important: Also keep your "Bill of Sale" as proof of purchase.

Serial no. Invoice no.
 Date purchased Dealer name

FOR SERVICE AND REPAIR, PLEASE VISIT
www.1800customersupport.com

FOR ADDITIONAL DECORATIVE SNAP-ON FRAME COVERS, PLEASE VISIT
www.snaponframes.com

Free Manuals Download Website

<http://myh66.com>

<http://usermanuals.us>

<http://www.somanuals.com>

<http://www.4manuals.cc>

<http://www.manual-lib.com>

<http://www.404manual.com>

<http://www.luxmanual.com>

<http://aubethermostatmanual.com>

Golf course search by state

<http://golfingnear.com>

Email search by domain

<http://emailbydomain.com>

Auto manuals search

<http://auto.somanuals.com>

TV manuals search

<http://tv.somanuals.com>