

VENTURER

STB7766G

ATSC Converter Box

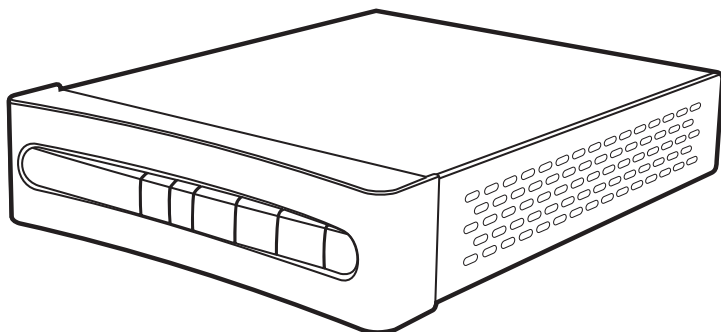

Instruction Manual

Need More Help?

DO NOT RETURN THIS PRODUCT TO THE STORE

Please visit online help at

<http://www.venturer.com>

SAFETY PRECAUTIONS

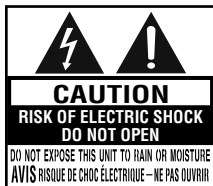

The lightning flash with an arrowhead symbol, within the equilateral triangle, is intended to alert the user to the presence of uninsulated "dangerous voltage" within the product's enclosure that may be of sufficient magnitude to cause an electric shock.



The exclamation point within the equilateral triangle is intended to alert the user to the presence of important operating and maintenance (servicing) instructions in this owner's manual.



WARNING:
TO REDUCE THE RISK OF ELECTRIC SHOCK, DO NOT REMOVE COVER (OR BACK). NO USER-SERVICEABLE PARTS INSIDE. REFER SERVICING TO QUALIFIED SERVICE PERSONNEL.

WARNING:
TO PREVENT FIRE OR SHOCK HAZARD, DO NOT EXPOSE THIS APPLIANCE TO RAIN OR MOISTURE. DO NOT PLACE OBJECTS FILLED WITH LIQUIDS ON OR NEAR THIS UNIT.



Equipment tested for compliance as a complete unit

This device complies with Part 15 of the FCC Rules. Operation is subject to the following two conditions: (1) This device may not cause harmful interference, and (2) this device must accept any interference received, including interference that may cause undesired operation.

This equipment has been tested and found to comply with the limits for a Class B digital device, pursuant to Part 15 of FCC Rules. These limits are designed to provide reasonable protection against harmful interference in a residential installation. This equipment generates, uses, and can radiate radio frequency energy and, if not installed and used in accordance with the instructions, may cause harmful interference to radio communications.

However, there is no guarantee that interference will not occur in a particular installation. If this equipment does cause harmful interference to radio or television reception, which can be determined by turning the equipment off and on, the user is encouraged to try to correct the interference by one or more of the following measures:

- Reorient or relocate the receiving antenna.
- Increase the separation between the equipment and receiver.
- Connect the equipment into an outlet on a circuit different from that to which the receiver is connected.
- Consult the dealer or an experienced radio/TV technician for help.

WARNING: Changes or modifications not expressly approved by the party responsible for compliance could void the user's authority to operate the equipment.

IMPORTANT SAFETY INSTRUCTIONS

1. Read these instructions.
2. Keep these instructions.
3. Heed all warnings.
4. Follow all instructions.
5. Do not use this apparatus near water.
6. Clean only with a dry cloth.
7. Do not block any of the ventilation openings. Install in accordance with the manufacturer's instructions.
8. Do not install near any heat sources such as radiators, heat registers, stoves, or other apparatus (including amplifiers) that produce heat.
9. Do not defeat the safety purpose of the polarized or grounding - type plug. A polarized plug has two blades with one wider than the other. A grounding type plug has two blades and a third grounding prong. The wide blade or the third prong is provided for your safety. When the provided plug does not fit into your AC power outlet, consult an electrician for replacement of the obsolete outlet.
10. Protect the power cord from being walked on or pinched particularly at plugs, convenience receptacles, and the point where they exit from the apparatus.
11. Only use attachments/accessories specified by the manufacturer.
12. Use only with a cart, stand, tripod, bracket, or table specified by the manufacturer, or sold with the apparatus. When a cart is used, use caution when moving the cart/apparatus combination to avoid injury from tip-over.
13. Unplug this apparatus during lightning storms or when unused for long periods of time.
14. Refer all servicing to qualified service personnel. Servicing is required when the apparatus has been damaged in any way, such as the power-supply cord or plug is damaged, liquid has spilled or objects have fallen into the apparatus, the apparatus has been exposed to rain or moisture, does not operate normally, or has been dropped.



**Portable Cart
Warning**

ACCESSORIES

<input type="checkbox"/> AC Adapter	x 1
<input type="checkbox"/> Remote Control	x 1
<input type="checkbox"/> AAA Batteries (for Remote Control)	x 2
<input type="checkbox"/> RF Cable	x 1

CONTENTS

Safety Precautions	1	On-Screen Menu-Option	13
Important Safety Instructions	2	Clock	13
Accessories	3	Aspect Ratio	13
Contents	3	Language	14
Remote Control	4	Audio Language	14
Quick Start Guide	5-6	Caption Select	14
Control Reference Guide	7-8	DCC View	15
Connections	9	Sleep Mode	15
Connecting a TV(Using the RF Cable)	9	On-Screen Menu-Lock	15
Connecting a TV(Using the AV Cable)	9	Lock System	15
Power Supply	10	Set Password	16
Using the AC Adapter	10	Block Channel	16
Turning on the Unit	10	TV Rating-Children	16
Dolby Digital	10	TV Rating-General	16-17
Basic Operation	11	Movie Rating	17
Searching for Channels Automatically	11	Downloadable RRT	17
Viewing the TV Channel	11	Maintenance	18
Adjusting the Volume	11	Troubleshooting Guide	18
Viewing the Information	11		
Viewing Signal	11		
On-Screen Menu-Channel	12		
Channel Scan/Add/ Edit	12		
Manual Scan	12		
Output Channel	13		

REMOTE CONTROL

- Point the remote control at the REMOTE SENSOR located on the unit.
- When there is a strong ambient light source, the performance of the infrared REMOTE SENSOR may be degraded, causing unreliable operation.
- The recommended effective distance for remote operation is about 16 feet (5 meters).

To Install Batteries

1. Open the battery door.
2. Insert two AAA batteries.

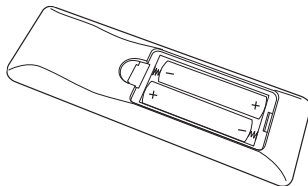
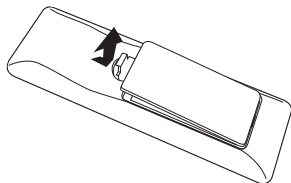

Battery Replacement

When the batteries become weak, the operating distance of the remote control is greatly reduced and you will need to replace them.



CAUTION: Danger of explosion if battery is incorrectly replaced. Replace only with the same or equivalent type.

Notes:

- If the remote control is not going to be used for a long time, remove the batteries to avoid corrosion damage caused by battery leakage.
- Do not mix old and new batteries. Do not mix ALKALINE, standard (CARBON-ZINC) or rechargeable (NICKEL-CADMIUM) batteries.
- Always remove batteries as soon as they become weak.
- Weak batteries can leak and severely damage the remote control.
- **WARNING:** Do not dispose of batteries in a fire. Batteries may explode or leak.

QUICK START GUIDE

STEP 1: CONNECTIONS

Option One: Using the RF Cable to Connect a TV

1. Connect an antenna cable to the **RF IN** terminal on the rear of the unit.
2. Use the RF cable (included) to connect the unit and TV/Monitor.
3. Use the AC adapter (included) to connect a suitable wall outlet. The supplied 9V adapter operates on AC 120V ~ 60Hz.
4. Turn on your TV and switch TV's channel selection to **Channel 4**.

Note:

- If a local TV Station happens to broadcast on Channel 4, we recommend you switch the unit's RF Output Channel to Channel 3 (and switch TV to Channel 3), following the instructions on Page 13.

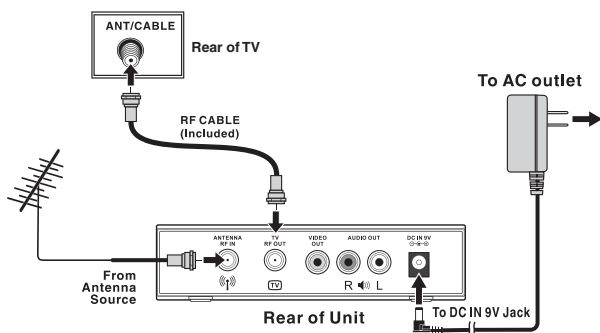

Option Two: Using the AV Cable to Connect a TV

1. Connect an antenna cable to the **RF IN** terminal on the rear of the unit.
2. Use the AV Cable (not included) to connect the unit and TV/Monitor.
3. Use the AC adapter (included) to connect a suitable wall outlet. The supplied 9V adapter operates on AC 120V ~ 60Hz.
4. Turn on your TV and follow the instructions included with it to select the "**AV IN**" function.

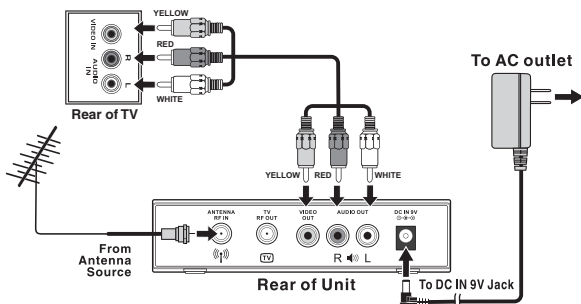

Warning: This system does not support cable TV.

QUICK START GUIDE

STEP 2: TURNING ON THE UNIT

1. While the AC adapter is connected and the unit is on standby, power will be consumed and the power indicator is RED.
2. Press the **STANDBY/ON** button to turn on the unit. The power indicator is GREEN.

STEP 3: SETTING THE OSD LANGUAGE

1. Press the **MENU** button on the remote control.
2. Use the **◀ / ▶** buttons to select the **OPTION** menu.
3. Use the **▼** button to select **Language** then press the **ENTER** button or the **▶** button.
4. Use the **▲ / ▼** buttons to select English / Español (Spanish) / Français (French).
5. Press the **EXIT** button on the remote control to exit menu.

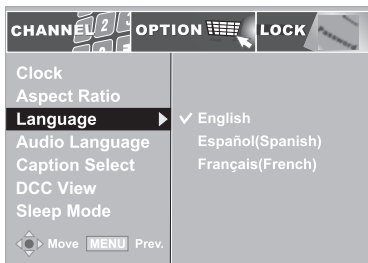

STEP 4: SEARCHING FOR CHANNELS AUTOMATICALLY

1. Press the **MENU** button on the remote control.
2. Use the **◀ / ▶** buttons to select the **CHANNEL** menu.
3. Use the **▼** button to select **Channel Scan** and press the **ENTER** button or the **▶** button to start scanning.

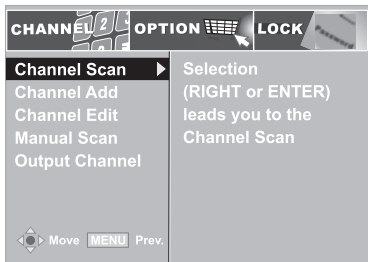

STEP 5: VIEWING THE TV CHANNEL

Press the **CH/CH+** buttons to select a channel, or press the number button on the remote to select the channel you want to watch.

- For channels 1 to 9, enter a one-digit channel number.
- For channels 10 to 69, enter the two-digit channel number.

Please read the Instruction Manual for further details on using the Converter Box.

CONTROL REFERENCE GUIDE

Remote Control

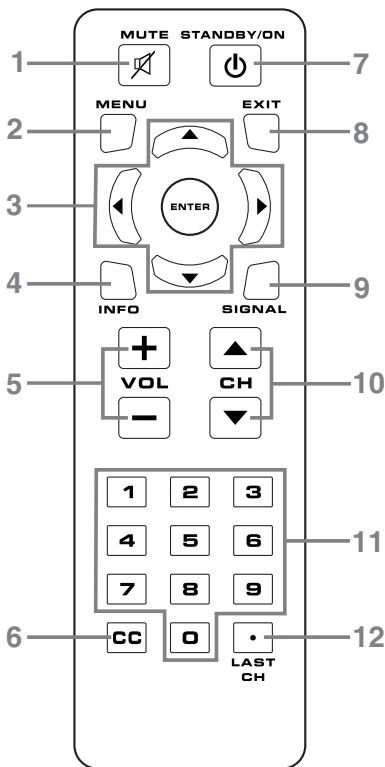

- 1) **MUTE Button**
Press to turn off the sound.
- 2) **MENU Button**
Press to display the on-screen menu or switch back to the previous menu screen.
- 3) **CURSOR (▲, ▼, ◀, ▶) Buttons**
Use to highlight selections on a menu screen and adjust certain settings.
ENTER Button
Confirm selection on a menu screen.
- 4) **INFO Button**
Press to display information on the current channel.
- 5) **VOL + / VOL - Button**
Press to increase/decrease the volume.
- 6) **CC Button**
Press to change the Closed Caption appearance. This function only works on programs broadcasted with captions.
- 7) **STANDBY/ON Button**
Press to turn ON the unit or put it in STANDBY (OFF) mode.
- 8) **EXIT Button**
Press to exit from the on-screen menu or a pop-up display.
- 9) **SIGNAL Button**
Press to display TV signal quality.
- 10) **CH ▲ / CH ▼ Buttons**
Press to select the channel upward or downward.
- 11) **NUMERIC Buttons**
Press to enter numbers or go directly to a specific channel.
- 12) **LAST CH**
Press to switch repeatedly between the last two channels displayed.
[dot] Button
Press to enter digital sub-channels with the numeric buttons (i.e. 11.3 or 12.7).

CONTROL REFERENCE GUIDE

Front View

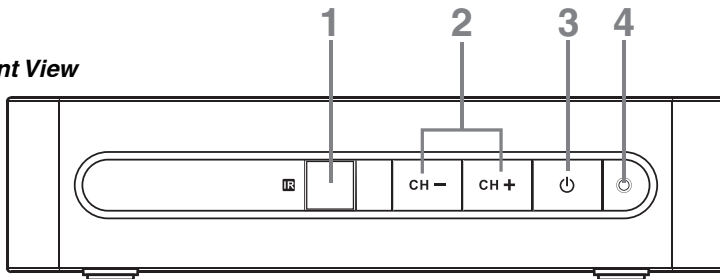

Back View

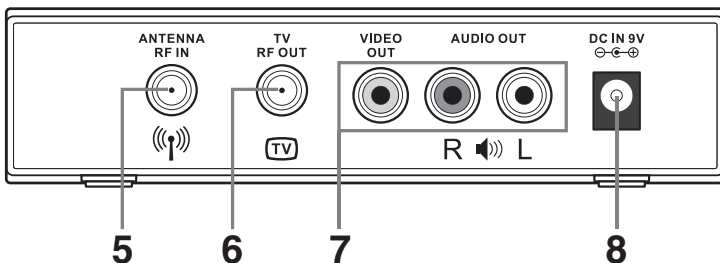

- 1) Remote Sensor**
Receives infrared signals from the remote control.
- 2) CH-/CH+ Buttons**
Press to select the channel upward or downward.
- 3) ⏻ Button**
Turns the power on or restores the unit to the standby mode.
- 4) STANDBY/ON Indicator**
Green: power on
Red: standby mode
- 5) ANTENNA RF IN Terminal**
Connect the AIR antenna.
- 6) TV RF OUT Terminal**
Use to connect your TV using a coaxial cable. Analog RF signals output from the TV RF OUT terminal.
- 7) AUDIO OUT / VIDEO OUT Jacks**
Outputs audio/video signals to a connected TV.
- 8) DC IN 9V Jack**
Connect the supplied AC adapter.

CONNECTIONS

Connecting a TV (Using the RF Cable)

1. Connect an antenna cable to the **RF IN** terminal on the rear of the unit.
2. Use the RF cable (included) to connect the unit and TV/Monitor as shown.
3. Turn on your TV and switch TV's channel selection to Channel 4.

Note:

- If a local TV Station happens to broadcast on Channel 4, we recommend you switch the unit's RF Output Channel to Channel 3 (and switch TV to Channel 3), following the instructions on Page 13.

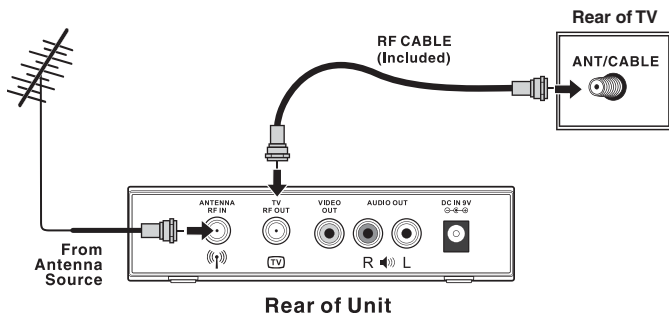

Connecting a TV (Using the AV Cable)

1. Connect an antenna cable to the **RF IN** terminal on the rear of the unit.
2. Use the AV Cable (not included) to connect the unit and TV/Monitor as shown.

Note:

Make sure to turn on your TV and follow the instructions included with it to select the "AV IN" function.

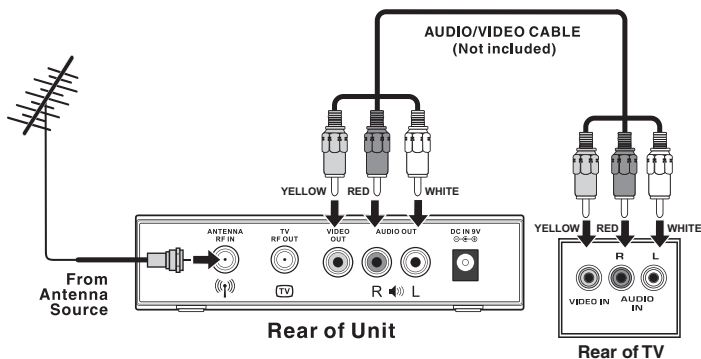

Warning: This system does not support cable TV.

POWER SUPPLY

Using the AC Adapter

The supplied 9V adapter operates on AC 120V ~ 60Hz.

While the AC adapter is connected and the unit is on standby, power will be consumed and the power indicator is RED.

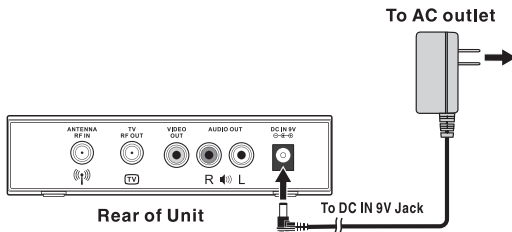

Cautions:

- The AC adapter included with this unit is for its use only. Do not use it with other equipment.
- When the unit is not going to be used for a long period of time, disconnect the AC adapter from the AC power outlet.
- When the AC adapter is plugged in, the apparatus is not completely disconnected from the main power supply, even when the power is turned off.

Turning on the Unit

Press the  STANDBY/ON button to turn on the unit. The power indicator is GREEN.

Dolby Digital

Manufactured under license from Dolby Laboratories.
“Dolby” and the double-D symbol are trademarks of Dolby Laboratories.



BASIC OPERATION

Searching for Channels Automatically

1. Press the **MENU** button on the remote control.
2. Use the ◀/▶ buttons to select the **CHANNEL** menu.
3. Use the ▼ button to select **Channel Scan** and press the **ENTER** button or the ▶ button to start scanning.

Notes:

- The unit **MUST** be connected to an antenna in order to receive digital TV signals.
- If you wish to stop scanning in the middle of the scanning process, press the **ENTER** button.

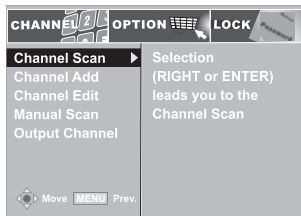

Viewing the TV Channel

Viewing a television station after searching for channels.

Press the **CH ▲ / CH ▼** buttons to select a channel, or press the number button on the remote to select the channel you want to watch.

- For channels 1 to 9, enter a one-digit channel number.
- For channels 10 to 69, enter the two-digit channel number.

Adjusting the Volume

You can control the volume using the buttons on the remote control.

VOL-/VOL+ Buttons

Use these buttons to increase or decrease the volume.

MUTE Button

This button is used to mute the sound of the unit. No audio will be heard once this button is pressed.

To cancel the mute action, press the **MUTE** button again.

Viewing the Information

You can view information for the current TV program by pressing the **INFO** button on the remote control.

The INFO shows:

- The major channel number and the minor channel number if you are viewing a digital channel
- Current time and date
- Program title and other information if available
- The current program's rating
- Broadcast format of current program
- Multilingual
- Caption

To hide INFO:

Press the **INFO** button again or press the **EXIT** button.

Viewing Signal

To view the signal quality, press the **SIGNAL** button on the remote control. A beep sound will be heard.

ON-SCREEN MENU - CHANNEL

Use the menu configuration to set detailed options for each function. Press the **MENU** button on the remote control to open the menu screen.

- To return to the previous menu press the **MENU** button on the remote control.
- To exit the menu screen press the **EXIT** button on the remote control.

Channel Scan

See “Searching for Channels Automatically” for details.

Channel Add

1. Press the **MENU** button on the remote control.
2. Use the ◀/▶ buttons to select the **CHANNEL** menu.
3. Use the ▼ button to select **Channel Add** then press the **ENTER** button or the ▶ button.

Note: Valid channels which are already stored before you use Channel Add will be skipped during the channel scan process.

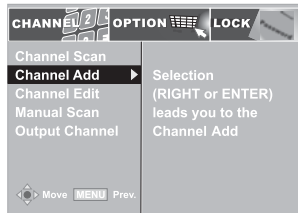

Channel Edit

1. Press the **MENU** button on the remote control.
2. Use the ◀/▶ buttons to select the **CHANNEL** menu.
3. Use the ▼ button to select **Channel Edit** then press the **ENTER** button or the ▶ button.
4. Use the ▲/▼ buttons to select the channel number then press the **ENTER** button.

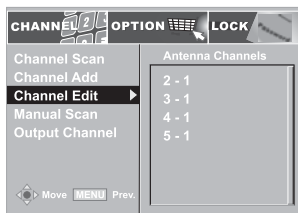

Manual Scan

In the case of Terrestrial TV with an indoor/outdoor antenna, Channel Scan may not find all existing channels because a certain channel may require the antenna to be adjusted to different orientation. You can add such a channel by entering the channel number manually.

1. Press the **MENU** button on the remote control.
2. Use the ◀/▶ buttons to select the **CHANNEL** menu.
3. Use the ▼ button to select **Manual Scan** then press the **ENTER** button or the ▶ button.
4. Use the ▲/▼ buttons to select the channel number then press the **ENTER** button.

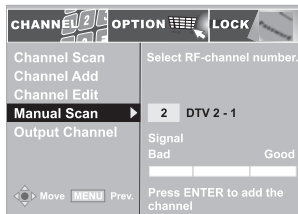

ON-SCREEN MENU - CHANNEL

Output Channel

You can select NTSC RF output channel.

1. Press the **MENU** button on the remote control.
2. Use the ◀/▶ buttons to select the **CHANNEL** menu.
3. Use the ▼ button to select **Output Channel** then press the **ENTER** button or the ▶ button.
4. Use the ▲/▼ buttons to select the channel number.

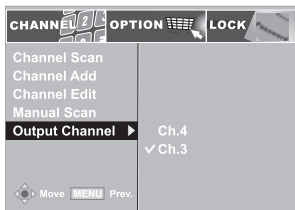

ON-SCREEN MENU - OPTION

Clock

1. Press the **MENU** button on the remote control.
2. Use the ◀/▶ buttons to select the **OPTION** menu.
3. Use the ▼ button to select **Clock** then press the **ENTER** button or the ▶ button.
4. Press the ◀/▶ buttons to select the Time Zone (Eastern/Central/Mountain/Pacific/Alaska/Hawaii/New F.land/Atlantic).

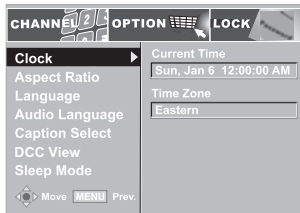

Aspect Ratio

1. Press the **MENU** button on the remote control.
2. Use the ◀/▶ buttons to select the **OPTION** menu.
3. Use the ▼ button to select **Aspect Ratio** then press the **ENTER** button or the ▶ button.
4. Use the ▲/▼ buttons to select the options (Set By Program/Letter Box/Cropped/Squeezed).

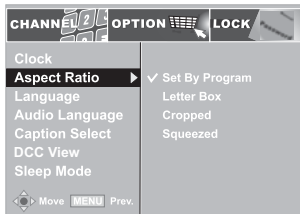

Set By Program: Displays all programs based on the aspect ratio of the program.

Letter Box: Displays all programs in 16:9 aspect ratio.

Cropped: No change on the ratio, but the picture is cropped.

Squeezed: All programs are displayed to fit on the screen.

ON-SCREEN MENU - OPTION

Language

1. Press the **MENU** button on the remote control.
2. Use the **◀/▶** buttons to select the **OPTION** menu.
3. Use the **▼** button to select **Language** then press the **ENTER** button or the **▶** button.
4. Use the **▲/▼** buttons to select English / Español (Spanish) / Français (French).

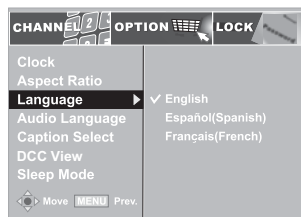

Audio Language

When you change the channel on Digital TV, you may be able to listen to the audio in an alternate language by selecting the appropriate language option. If there is no selected audio language, the primary audio signal transmitted by the TV broadcaster is selected automatically.

Note: Not all TV channels broadcast with multiple languages.

1. Press the **MENU** button on the remote control.
2. Use the **◀/▶** buttons to select the **OPTION** menu.
3. Use the **▼** button to select **Audio Language** then press the **ENTER** button or the **▶** button.
4. Use the **▲/▼** buttons to select the audio language (English / Spanish / French).



Caption Select

1. Press the **MENU** button on the remote control.
2. Use the **◀/▶** buttons to select the **OPTION** menu.
3. Use the **▼** button to select **Caption Select** then press the **ENTER** button or the **▶** button.
4. Use the **▲/▼** buttons to select the options (ACC/DCC/DCC Service). "ACC" is Analog TV Closed Caption. "DCC" is Digital TV Closed Caption.
5. Use the **◀/▶** buttons to make adjustments.

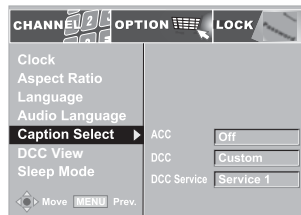

Standard: Use the default digital caption style from broadcaster.

Custom: Activate the DCC View item and set your desired font settings.

Notes:

- If DCC (Digital Closed Caption) is set to Custom, DCC View is activated.
- Caption is essential for a hearing-impaired person.
- If both ACC (Analog Closed Caption) and DCC are on service and both settings are ON, only DCC is displayed.
- ACC is available only when DCC is OFF.

ON-SCREEN MENU - OPTION

DCC View

Use this to set the character font. Only DCC (Digital Closed Caption) is set to Custom, DCC View is activated.

1. Press the **MENU** button on the remote control.
2. Use the ◀/▶ buttons to select the **OPTION** menu.
3. Use the ▼ button to select **DCC View** then press the **ENTER** button or the ▶ button.
4. Use the ▲/▼ buttons to select the options, then use the ◀/▶ buttons to make adjustments.

Notes:

- To activate DCC View, DCC on Caption Select should be set to 'Custom'.

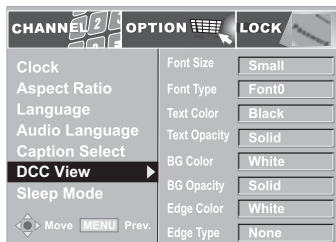

Sleep Mode (Power Save Mode)

This product is currently set to Power Save Mode (Sleep mode). It will not receive TV signal after 4 hours of inactivity.

1. Press the **MENU** button on the remote control.
2. Use the ◀/▶ buttons to select the **OPTION** menu.
3. Use the ▼ button to select **Sleep Mode** then press the **ENTER** button or the ▶ button.
4. Use the ▲/▼ buttons to select the options (Off / 1 hour / 2 hours / 4 hours / 8 hours).

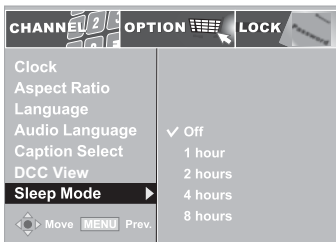

ON-SCREEN MENU - LOCK

Lock System

1. Press the **MENU** button on the remote control.
2. Use the ◀/▶ buttons to select the **LOCK** menu.
3. Use the ▼ button to position the cursor on the input field and enter password. If you have not specified the password, input the factory-default code, "0000".
4. Use the ▲/▼ buttons to select **Lock System** then press the **ENTER** button or the ▶ button.
5. Use the ▲/▼ buttons to select On/Off.

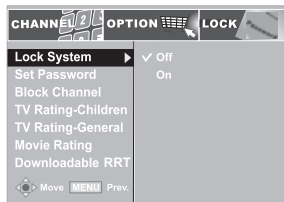
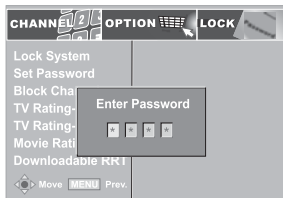

ON-SCREEN MENU - LOCK

Set Password

1. Press the **MENU** button on the remote control.
2. Use the **◀/▶** buttons to select the **LOCK** menu.
3. Use the **▲/▼** buttons to select **Set Password** then press the **ENTER** button or the **▶** button.
4. Enter values (4 digit) for new password and again to confirm password.

Notes:

- Remember your password if you have changed it.
- If you forget the password, enter "8888" to unlock parental control.

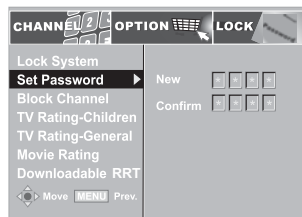

Block Channel

1. Press the **MENU** button on the remote control.
2. Use the **◀/▶** buttons to select the **LOCK** menu.
3. Use the **▲/▼** buttons to select **Block Channel** then press the **ENTER** button or the **▶** button.
4. Use the **▲/▼** buttons to select Antenna Channel then press the **ENTER** button.

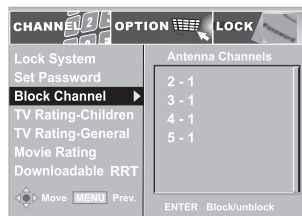

TV Rating-Children

TV Rating-Children is for classifying the age level of TV programs for children.

1. Press the **MENU** button on the remote control.
2. Use the **◀/▶** buttons to select the **LOCK** menu.
3. Use the **▲/▼** buttons to select **TV Rating-Children** then press the **ENTER** button or the **▶** button.
4. Use the **▲/▼** buttons to select **Age** or **Fantasy Violence** then press the **ENTER** button or the **▶** button.
5. Use the **▲/▼** buttons to block/unblock rating. If Blocking is set to ON, a lock icon is indicated.

- Age restriction has higher priority than the others (Fantasy Violence).

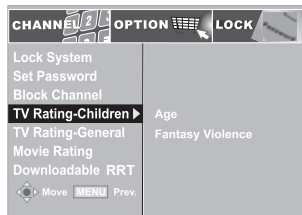

TV Rating-General

TV Rating-General is for classifying the age level of TV programs by the general criterion.

1. Press the **MENU** button on the remote control.
2. Use the **◀/▶** buttons to select the **LOCK** menu.
3. Use the **▲/▼** buttons to select **TV Rating-General** then press the **ENTER** button or the **▶** button.
4. Use the **▲/▼** buttons to select the options (**Age / Dialogue / Language / Sex / Violence**) then press the **ENTER** button or the **▶** button.
5. Use the **▲/▼** buttons to block/unblock rating. If Blocking is set to ON, a lock icon is indicated.

- Age restriction has higher priority than the others.

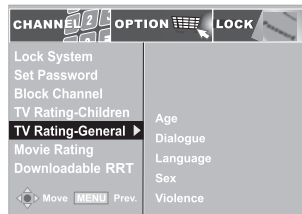

ON-SCREEN MENU - LOCK

The lock levels are equivalent to the following ratings.

TV-Y: All children.

TV-PG: Parental guidance suggested.

TV-Y7: Children 7 years and older.

TV-14: Parents strongly cautioned.

TV-G: General Audience.

TV-MA: Mature audience only.

Movie Rating

1. Press the **MENU** button on the remote control.
2. Use the ◀/▶ buttons to select the **LOCK** menu.
3. Use the ▲/▼ buttons to select **Movie Rating** then press the **ENTER** button or the ▶ button.
4. Use the ▲/▼ buttons to select the rating.

The lock levels are equivalent to the following ratings.

G : GENERAL AUDIENCES, Suitable for all ages.

R : RESTRICTED, Under 17 requires accompanying parent or adult guardian for viewing in movie theaters.

PG : PARENTAL GUIDANCE SUGGESTED - Some material may not be suitable for children.

NC-17 : No one 17 or under admitted in movie theaters.

PG-13 : PARENTS STRONGLY CAUTIONED - Some material may be inappropriate for children under 13.

X : Adults Only.

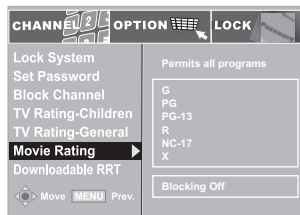

Downloadable RRT

1. Press the **MENU** button on the remote control.
2. Use the ◀/▶ buttons to select the **LOCK** menu.
3. Use the ▲/▼ buttons to select **Downloadable RRT** then press the **ENTER** button or the ▶ button.
4. Use the ▲/▼ buttons to select the Region Rating Tables or Clear Rating Table then press the **ENTER** button or the ▶ button.
5. Use the ▲/▼ buttons to select the rating.

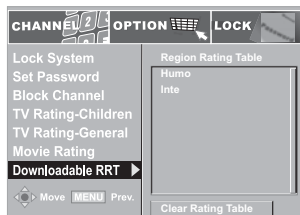

Notes:

- Region Rating Table (RRT) options are different according to the current program.
- Select Clear Rating Table to reset the RRT options.

MAINTENANCE

Cleaning the Unit

- Be sure to turn the unit off and disconnect the AC adapter before maintaining the unit.
- Wipe the unit with a dry soft cloth. If the surfaces are extremely dirty, wipe clean with a cloth that has been dipped in a weak soap-and-water solution and wrung out thoroughly. Wipe with a dry cloth.
- Never use alcohol, benzine, thinner, cleaning fluid or other chemicals. Do NOT use compressed air to remove dust.

TROUBLESHOOTING GUIDE

<i>SYMPTOM</i>	<i>CAUSE (AND REMEDY)</i>
No power.	<ul style="list-style-type: none">• Ensure the AC adapter is connected.• The unit is not turned on.
Intermittent signal, or no signal at all	<ul style="list-style-type: none">• Try to tune to another channel.• Make sure the antenna connected.• Adjust the antenna for a stronger signal.• This system does not support cable TV.
Poor sound quality, or no sound	<ul style="list-style-type: none">• Make sure you have connected your audio system correctly.• Try to tune to another channel. Sometimes broadcasters have problems with DTV audio encoding.• Make sure the MUTE function on your TV is not set.
Remote control doesn't work correctly	<ul style="list-style-type: none">• Remove any obstacles between the remote and the unit.• Use the remote near the unit.• Point the remote at the remote sensor on the unit.• Replace the batteries in the remote.

Specifications and external appearance are subject to change without notice.

LIMITED WARRANTY

VENTURER ELECTRONICS ("VENTURER") makes the following limited warranty. This limited warranty extends to the original consumer purchaser and is limited to non-commercial use of the product.

One Year Parts & Labor Warranty

VENTURER products purchased in the United States are warranted to be free from defects in materials or workmanship for a period of one year from the date of their original retail purchase. If the unit fails to conform to this warranty, we will service the product using new or refurbished parts and products, at **VENTURER's** sole discretion.

During a period of 1 year from the effective warranty date, **Venturer** will provide, when needed, service labor to repair a manufacturing defect at its designated Service Center. To obtain warranty service in the United States, you must first call our **Customer Support Center at 1-800-252-6123 during the hours listed in the box below**. The determination of service will be made by **Venturer** Customer Support. **PLEASE DO NOT RETURN YOUR UNIT TO VENTURER WITHOUT PRIOR AUTHORIZATION**. New or remanufactured replacements for defective parts or products will be used for repairs by **Venturer** at its designated Service Center for 1 year from the effective warranty date. Such replacement parts or products are warranted for an additional 1 year from the date of repair or replacement. The Customer will be required to ship the unit to the Service Center indicated at the time Customer Support is contacted to make the necessary repairs. The customer is responsible for all transportation charges to the service facility.

Packaging and Shipping Instruction

When you send the product to the **Venturer** service facility you must use the original carton box and packing material or an equivalent as designated by **VENTURER**.

LIMITED WARRANTY

YOUR RESPONSIBILITY

- (1) You must retain the original sale receipt to provide proof of purchase.
- (2) These warranties are effective only if the product is purchased and operated in the U.S.A. or Canada.
- (3) Warranties extend only to defects in material or workmanship, and do not extend to any product or parts which have been lost or discarded, or damage to product or parts caused by misuse, accident, improper operation or maintenance, or use in violation of instructions provided with the product, or to product which has been altered or modified without authorization of **Venturer**, or to products or parts thereof which have had the serial number removed or changed.

In the event your product requires repair after the limited warranty period has expired, please contact our Customer Support Center at **1-800-252-6123** or **www.venturer.com**

Hours: Monday–Thursday: 9–7, Friday: 9–5, Saturday: 9–12 EST.

IMPORTANT:

YOU ARE RESPONSIBLE FOR ANY TRANSPORTATION, SHIPPING OR INSURANCE RELATIVE TO THE RETURN OF PRODUCT TO OUR PRODUCT RETURNS CENTER.

All warranties implied by state law, including the implied warranties of merchantability and fitness for a particular purpose, are expressly limited to the duration of the limited warranties set forth above. With the exception of any warranties implied by state law as hereby limited, the foregoing warranty is exclusive and in lieu of all other warranties, guarantees, agreements and similar obligations of manufacturer or seller with respect to the repair or replacement of any parts. In no event shall **Venturer** be liable for consequential or incidental damages.

No person, agent, distributor, dealer or company is authorized to change, modify or extend the terms of these warranties in any manner whatsoever. The time within action must be commenced to enforce any obligation of **VENTURER** arising under the warranty or under any statute, or law of the United States or any state thereof, is hereby limited to 1 year from the date of purchase. This limitation does not apply to implied warranties arising under state law.

This warranty gives you specific legal rights and you may also have other rights, which may vary, from state to state. Some states do not allow limitation on how long an implied warranty lasts, when an action may be brought, or the exclusion or limitation of incidental or consequential damages, so the above provisions may not apply to you.

For more information on other products and services, please visit our website at **www.venturer.com**.

Model no. Product name

Type of set

Serial no. Invoice no.

Date purchased Dealer name

FOR SERVICE AND REPAIR, PLEASE CALL **1-800-252-6123**

Free Manuals Download Website

<http://myh66.com>

<http://usermanuals.us>

<http://www.somanuals.com>

<http://www.4manuals.cc>

<http://www.manual-lib.com>

<http://www.404manual.com>

<http://www.luxmanual.com>

<http://aubethermostatmanual.com>

Golf course search by state

<http://golfingnear.com>

Email search by domain

<http://emailbydomain.com>

Auto manuals search

<http://auto.somanuals.com>

TV manuals search

<http://tv.somanuals.com>