

TRANZ 330 Reference Manual

VeriFone Part Number 00483 - Revision D
Manual Revision 3.01



TRANZ 330 Reference Manual

VeriFone Part Number 00483, Revision D
Manual Revision Number 3.01

Published: April 1990

VeriFone™, Inc.
Technical Publications Group
100 Kahelu Avenue
Mililani, Hawaii
(808) 637-2911
Telex: 5106007959 VERIFONE

Printed in the United States of America

Copyright© 1990 VeriFone, Inc. All rights reserved.

No part of this publication may be copied, distributed, stored in a retrieval system, translated into any human or computer language, transmitted, in any form or by any means, without the prior written consent of VeriFone, Inc. VeriFone™ and TRANZ 330™ are trademarks of VeriFone, Inc.

IBM®, IBM PC® and IBM AT® are registered trademarks of International Business Machines.

Table of Contents

1. Introduction

Display Panel	1-2
Keypad	1-2
Cardreader	1-2
Telephone Jacks	1-3
Serial Port.....	1-3
PIN Pad/Bar Code Wand Port	1-3
Power Pack	1-3
Cable Routing Channels	1-3
Optional Printers.....	1-3
Slip Printer	1-3
Roll Printers	1-4
Printer 500	1-4
Optional Telephone.....	1-4
Internal Modem	1-4
Optional Bar Code Wand.....	1-4
Optional PIN Pads	1-5

2. Installation

Selecting a Location for your Terminal	2-1
Unpacking.....	2-1
Telephone Line Connection	2-2
Connecting a Standard Telephone (optional).....	2-2
Connecting the Printer 150 (optional)	2-2
Connecting the Printer 250 (optional)	2-3
Connecting the Printer 500 (optional)	2-4
Connecting the Printer 600 (optional)	2-5
Connecting the Bar Code Wand (optional)	2-5
Connecting the PIN Pad 201 (optional)	2-6
Connecting the PIN Pad 101 (optional)	2-6
Connecting the Terminal Power Pack	2-7
Routing Cords in the Cable Channels (optional)	2-7

Table of Contents

3. Downloading

TRANZ 330 Downloading	3-1
Terminal-to-Terminal Direct Download	3-1
Master/Slave Considerations	3-2
On the master terminal:	3-2
On the slave terminal:.....	3-3
On both terminals:	3-4
Direct PC Downloads	3-4
Telephone Download	3-5
Download Prompts for Empty Memory Locations	3-5
Telephone Download Procedure	3-6
BuyPass Download.....	3-7

4. How the TRANZ 330 Works

Host Transactions	4-1
Local Functions	4-2
Applications	4-2
Standard Application	4-2
Custom Applications.....	4-2
Programming a Custom Application	4-3
Programming with the Keypad.....	4-3
RAM and ROM Memory.....	4-3
Memory Locations	4-3
Terminal Parameters.....	4-4
Transaction Parameters	4-4
Multiple Transactions	4-5
Networks.....	4-5

Table of Contents

5. Basic Operation

Startup	5-1
Host Transaction Keys	5-1
Using the Cardreader	5-1
Using the Optional Bar Code Wand	5-2
Memory Dialing	5-2
Entering Alphanumeric Data From the Keypad	5-3
Using the STORE Function.....	5-4
Using the RECALL Function	5-6
Displaying Information	5-6
Adding and Changing Information.....	5-7
Using the Multiple Transaction Function.....	5-7
Using the POST Function	5-8
Resetting the Calendar/Clock	5-9
Changing the System Password.....	5-11
Programming Error	5-12
Error Condition Recovery	5-12
Error Condition Display and Override.....	5-13
Re-initialize Memory Procedure.....	5-13
Programming Error Override	5-13

6. Terminal Parameters

Entering Terminal/Location Parameters.....	6-2
Download Phone Number	6-2
Serial Number	6-3
Program Date	6-3
Message Sequence Number.....	6-3
Multiple Transaction Timeout	6-4
Scroll Length	6-4
Terminal Key Beep Flag	6-4
Dial Type Flag	6-5
Dial Speed Flag.....	6-5
Parallel Phone Available Flag	6-6
Number of Retries	6-6

Table of Contents

6. Terminal Parameters (continued)

Telephone Line Test Flag	6-6
RECALL, Set Clock, Unit-to-Unit Restriction Flag	6-7
Application ID	6-7
Idle Prompt	6-7
Auto Answer Control String.....	6-7
Memory Dial Phone Numbers	6-8
Printer Type.....	6-8
Printer 200/250 Paper Advance.....	6-8
Generic Printer Baud Rate.....	6-9
Generic Printer Data Format.....	6-9
Generic Printer Handshake.....	6-9
Bell/CCITT Mode.....	6-10
Dial-Up Line Upload/Download Speed	6-10
Auto Answer Speed	6-10
Auto Answer Processing.....	6-11
Auto Answer Packet Inactivity Timeout	6-11
PIN Pad/Bar Code Wand Serial Port Function.....	6-11
Line Recovery Time	6-12
Idle Loop Control String	6-12
Host for Card Transactions	6-12
Host for Bar Code Transactions	6-12

7. Entering Transaction Parameters

Transaction Parameters	7-1
Primary Phone Number.....	7-2
Secondary Phone Number.....	7-2
Call Center Phone Number.....	7-3
Referral Phone Number	7-3
Merchant Identification Number	7-4
Transaction Format Flag.....	7-4
Fraud Control Flag	7-5
Transaction Control String	7-6
Transaction Type Prompt.....	7-6

Table of Contents

7. (continued)

Floor Limit.....	7-6
Response Analysis Control String	7-7
Auxiliary Control String.....	7-7
Multiple Transaction Group Code	7-7
Login Strings	7-8
Soft Login	7-9

8. Maintenance and Diagnostics

Cleaning	8-1
Returning the TRANZ 330 Terminal for Service.....	8-1
Troubleshooting.....	8-1
Error Messages	8-1
Display Panel Does Not Display Correct Information	8-2
Telephone Does Not Work Properly	8-2
Printer Does Not Work	8-2
Bar Code Wand Does Not Work.....	8-2
PIN Pad Does Not Work.....	8-2
Terminal Transactions do not Work.....	8-3
Keypad does not Respond.....	8-3
TRANZ 330 Diagnostics.....	8-4
TRANZ 330 Memory Test.....	8-4
TRANZ 330 Keypad Test.....	8-4
TRANZ 330 Display Test	8-5
TRANZ 330 Display Messages Test.....	8-5
TRANZ 330 Card Reader Test	8-6
Resetting the TRANZ330 Calendar/Clock	8-6
TRANZ 330 Bar Code Wand Test	8-6
TRANZ 330 Transaction Simulation	8-7

Appendix A. Memory Locations

Functional Listing of Memory Locations	A-1
Terminal Parameters	A-1
Buffers.....	A-1

Table of Contents

Appendix A. (continued)

Miscellaneous	A-1
Login Strings and Function Key Control Strings	A-2
General Records	A-2
Idle Loop	A-2
Auto Answer	A-3
Printer Information	A-3
Host Parameters	A-3
Numeric Listing of Memory Locations	A-3

Appendix B. Features and Specifications

Microprocessor	B-1
Memory	B-1
Cardreader	B-1
Display	B-1
Miscellaneous	B-1
Communication	B-1
Modem	B-1
Restricted Memory Accessibility	B-2
Multiple Transaction Capability	B-2
Custom Security and Fraud Control	B-2
User Programmable Password	B-2
Selection of Transaction Data Formats	B-2
Power Requirements	B-2
Environmental	B-2
Dimensions and Weight	B-2
RS232 Serial Port 8-Pin DIN Connector	B-3
PIN Pad/Bar Code Serial Port 6-Pin DIN Connector	B-3
Serial Telephone Line (modem) Interface	B-3
Accessories	B-4
Direct Download Cable	B-4
Printers	B-4
Peripheral Devices	B-4
Programming Languages	B-4
Reference Manual	B-4

Table of Contents

Appendix C. Prompts and Error Messages

Appendix D. TRANZ 330 (202) Leased Line Terminal

Basic Operation.....	D-1
Entering Terminal Parameters	D-2
Poll Address.....	D-2
Keyboard ID.....	D-2
Poll Timeout Period.....	D-3
Downloading.....	D-3
Tinet Standard Leased Line Download	D-3
Tinet Cluster Leased Line Download	D-4
Host Initiated or Forced Downloads	D-5
Maintenance/Diagnostics	D-5
NAK Counter.....	D-5
Tx/Rx Status Display	D-5
Leased Line Integrity Test	D-5
Programming Considerations	D-6
Standard TRANZ 330	D-6
Cluster TRANZ 330	D-6
Protocol Considerations	D-6
Standard TRANZ 330 (202).....	D-7
Cluster TRANZ 330 (202).....	D-7
Error Messages	D-7
Memory Locations	D-8

Glossary

Index

About This Manual

This manual is designed to be used as a reference for the TRANZ 330 terminal. The manual is divided into eight sections:

- Introduction
- Installation
- Downloading
- How the Terminal Works
- Basic Operation
- Terminal Parameters
- Transaction Parameters
- Maintenance and Diagnostics
- Appendices

TRANZ 330 Manual Sections

TRANZ 330 is a powerful, compact transaction terminal which supports a Bar Code Wand or an encrypting PIN Pad and will drive the VeriFone Printer 150, 250, 500 or 600. These enhanced functions make the TRANZ 330 terminal a breakthrough POS terminal for its size and price.

Section 1, "Introduction," gives you some background information on the TRANZ 330 and includes descriptions of the terminal's hardware and optional peripheral features.

Section 2, "Installation," outlines the steps you should follow to install your terminal to the communication and power sources and to optional peripherals.

Section 3, "Downloading," covers the methods of downloading data to one or more TRANZ 330 terminals.

Section 4, "How the TRANZ 330 Works," gives you the basic concepts on the terminal's capabilities and functions, such as host transactions, local functions and terminal and transaction parameters.

Section 5, "Basic Operation," explains how to perform some of the basic TRANZ 330 operations.

Section 6, "Terminal Parameters," describes the terminal parameters and includes a worksheet to help you enter these parameters into the memory locations of the terminal.

Section 7, "Transaction Parameters," provides the transaction parameters of the TRANZ 330.

TRANZ 330 Applications

Section 8, "Maintenance and Diagnostics," includes maintenance, troubleshooting and diagnostic procedures for the TRANZ 330.

The appendices included in this manual provide supplemental information on the TRANZ 330 leased-line terminal, terminal memory locations, prompts and error messages and features and specifications.

This manual is a reference guide for installing your TRANZ 330 terminal and also describes some of the basic operations of the unit. However, the actual operations and procedures used with the TRANZ 330 depends on the application loaded into the terminal.

An application is a set of instructions stored in your terminal. All TRANZ 330 terminals are equipped with a standard application. However, your terminal may also be supplied with a custom application to perform special transactions used by your company.

To learn how your custom TRANZ 330 application fits within the daily operations of your company or financial institution, refer to your custom application's reference manual.

FCC Warning

Warning: This equipment generates, uses, and can radiate radio frequency energy. If not installed and used in accordance with the manufacturer's instructions, it may cause interference with radio and television reception.

FCC (15) Registration Number:

This equipment complies with the limits for a Class A computing device pursuant to Subpart J of Part 15 of FCC rules, which are designed to provide protection against interference when operated in a commercial environment.

Operation of this equipment in a residential area may cause interference with television or radio reception. Users should take whatever measures are required to eliminate the interference.

If this equipment causes interference, try to correct the problem by:

- Reorienting the receiving antenna.
- Relocating the terminal with respect to the receiver with which it interferes.
- Plugging the terminal into a different AC outlet, and putting the terminal and receiver on different branch circuits.

FCC Compliance:

This equipment complies with Part 68 of FCC Rules. Upon request, furnish the following information to the telephone company (telco).

- Manufacturer: VeriFone, Inc.
- Model: TRANZ 330 Terminal
- FCC registration number: B326BQ-14432-DT-E
- Ringer equivalence: 0.5A
- USOC modular telephone jack: RJ11

If the telephone company has any questions or problems, ask them to call the VeriFone Customer Support Department.

If you are located in the United States, call 800-654-1674. If you are located outside the United States, call 714-979-1870.

**Attention!
Canadian Users:**

Notice: The Canadian Department of Communications (DOC) label identifies certified equipment. This certification means the equipment meets certain telecommunications network protective, operational and safety requirements. The department does not guarantee the equipment will operate to a user's satisfaction.

Make sure your local telephone company will permit you to install this equipment. Use only the connection methods accepted by your telephone company. You should be aware, however, that compliance with the above conditions may not prevent degradation of service in some conditions.

Repairs to certified equipment should be made by an authorized Canadian maintenance facility designated by the supplier. Equipment malfunctions, or any equipment repairs and alterations made by a user, may give the telephone company cause to request the user to disconnect the equipment.

For your own protection, make sure that the electrical ground connections of the power utility, telephone lines and internal metallic water pipe system, if present, are connected together. This precaution may be particularly important in rural areas.

Caution: Do not attempt to make such connections yourself; contact the appropriate electric inspection authority or electrician.

**TRANZ 330 Terminal
Load Number:
(pending)**

The load number (LN) indicates the amount of load the terminal will add to a telephone loop. The loop may consist of any combination of devices, provided the sum of their load numbers does not exceed 100. If the sum exceeds 100, the loop may be overloaded.

An alphabetic suffix is also specified in the load number for the appropriate ringing type (A or B), if applicable. For example, LN = 38B designates a load number of 38 and a B-type ringer.

Service

Unless otherwise instructed in this reference manual, do not, under any circumstances, attempt any service, adjustments or repairs on this unit. Before returning a unit to VeriFone, call the VeriFone toll free number, 800-654-1674, and ask the service/repair department for an MRA (Material Return Authorization) number. You must have MRA number prior to returning your equipment for repair.

BABT Certification Information

Attention UK Users:

This special supplement describes parameters which, if misapplied, may invalidate BABT compliance. Carefully read this BABT Certification Supplement as it contains information that *overrides* any descriptions contained within the sections of this Reference Manual.

MODEL: TRANZ 330

REN: 0.5

Made in Taiwan

WARNING: *Interconnection directly, or by way of other apparatus, of ports marked in accordance with BS6301 cl 4.3.1(a) with ports not so marked may produce hazardous conditions in the BT network. Advice should be obtained from a competent engineer before such a connection is made.*

APPROVED for connection to telecommunications systems specified in the instructions for use subject to the conditions set out in them.

APPROVAL NUMBER S/3453/23/L/501749

This apparatus is intended only for use with the power supply included (VeriFone part number 01536-11). Other usage will invalidate any approval given to this apparatus if, as a result, it ceases to comply with BS6301:1982.

Users **MUST** use the supplied modular line cord. Obtain replacements from VeriFone (part number 01122-01).

The TRANZ 330 is suitable for connection to:

- The Public Switched Network provided by British Telecommunications plc or Kingston Communications
- PBX Extensions

The TRANZ 330 is suitable for household, office or similar general use. It is **NOT** suitable for use as an extension to a pay phone.

BABT Certification Supplement

BT lines supplied must support either loop disconnect or multi-frequency tone signalling.

The REN (Ringer Equivalent Number) of an item of telecommunications apparatus is an indication of the number of apparatus which can be connected in parallel on a direct exchange line and continue to provide an audible ringing signal. The maximum REN supported by a direct exchange line is 4, a standard telephone provided by BT has a REN of 1.

The approval of the modem for connection to the British Telecom public switched network is INVALIDATED if the apparatus is subject to any modification in any material way not authorised by BABT or is used with or connected to:

- Internal software that has not been formally accepted by BABT.
- External software or external control apparatus which causes the operation of the modem or associated call setup equipment to contravene the requirements of the Standard set out in BABT/SITS/82/005s/d.

All apparatus connected to the modem and thereby connected directly or indirectly to the British Telecom PSTN must be approved as defined in section 22(10) of the British Telecommunications Act 1984.

This apparatus has been approved for the use of the following facilities:

- Outdialling in LD and MF
- Autocalling
- Autocall initiation
- Autocall clearing
- Autoanswer

Any other usage will invalidate the approval of the apparatus if as a result it then ceases to conform with the standards against which approval was granted.

This apparatus is not to be used for making calls to the BT Emergency Service.

The apparatus user must check to see that all stored network addresses are properly programmed.

This apparatus is only approved for compatible PABXs. Consult the manufacturer or distributor for an up-to-date list of PABXs with which the apparatus is compatible. This unit has been tested and meets all requirements regarding secondary proceed indications for PABXs.

The following information describes memory locations and their associated contents that can invalidate BABT approval if set to improper values.

**Memory Location 000
Download Phone
Number**

This parameter is the phone number the terminal dials to connect to the host computer. The download phone number may contain the digits 0 thru 9, the characters * and # (when tone dialling is used) and a dash (-) as a two-second pause. Note that multiple sequential dashes are treated as a single delay. The delay is intended to allow a PABX sufficient time to return secondary proceed indication (second dial tone).

Important: This information applies to all other memory locations requiring telephone numbers. The apparatus user must check that all stored network addresses are correctly programmed.

**Memory Location 010
Dial Type Flag**

This parameter indicates the type of dialling the TRANZ 330 terminal uses. The following are valid:

Entry	Description
0	Tone Dial
1	Pulse Dial

**Memory Location 011
Dial Speed Flag**

This location must contain the following:

9, 20, 6, 15, 150

Any alteration to the above invalidates BABT approval.

**Memory Location 015
Auto Answer Delay**

This memory location sets the delay between incoming phone rings and execution of location 038 (auto answer control string).

**Memory Location 038
Auto Answer Control
String**

This location enables the TRANZ 330 terminal to respond to an incoming telephone ring and communicate with another dial-up device.

This memory location is usually empty and needs to be programmed for the auto answer control string to support communication between the TRANZ 330 and the remote dial-up device.

**Memory Location 958
Bell/CCITT Mode**

This memory location must be set to 1. Any alteration from this setting will invalidate BABT approval.

**Memory Location 966
Auto Answer
Processing**

This memory location must be set to 0 or 1. Any alteration from either of these settings will invalidate BABT approval.

BABT Certification Supplement

1. Introduction

TRANZ 330 is a powerful, compact electronic transaction terminal capable of gathering and transferring information at high speed. The terminal's versatility makes it ideal for many diverse applications including point-of-sale (POS) electronic payment transfer and authorization, time and attendance tracking, order entry, inventory and process tracking.

To perform credit authorizations and other transactions instantly and automatically, the TRANZ 330 communicates with a remote host computer via the telephone lines. Several modem options are available for communicating at different speeds and on different phone systems.

TRANZ 330 will simplify transactions and provide you with more flexibility, improved speed and greater accuracy. And, because TRANZ 330 can use a standard telephone line to access information from remote computers, you can easily install and use the terminal at any retail counter or office.

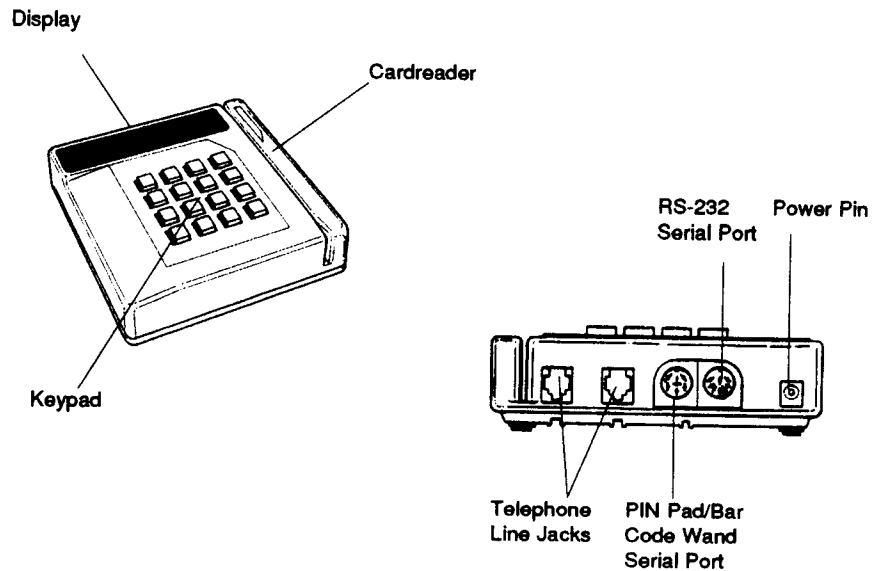

Figure 1-1 TRANZ 330 Terminal

Display Panel

The 16-character alphanumeric display panel provides you with the visual prompts and information needed to operate the TRANZ 330 terminal. This bright blue, vacuum fluorescent display is easy to read, even under poor lighting conditions. It displays fully-formed numerals, letters and punctuation symbols.

Keypad

As Figure 1-2 illustrates, the keypad has 16 keys for entering alphabetical and numeric data. The actual functions of each key will vary depending on your terminal's application. Refer to your application manual for the operations associated with each key.

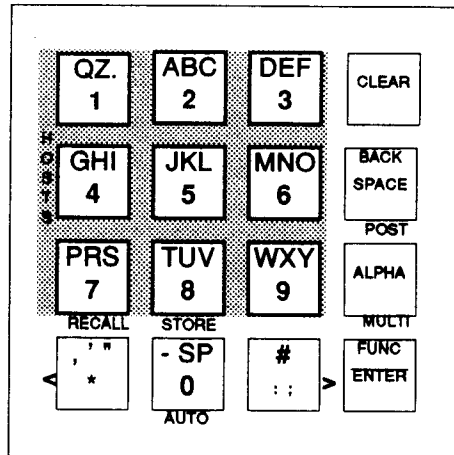

Figure 1-2 TRANZ 330 Keypad

Cardreader

TRANZ 330 features an ABA track 2 cardreader (slot on the right side) for reading the magnetic stripe data of most major credit, private and debit cards. For special applications, an optional ISO track 1 cardreader can be installed instead of the ABA track 2 cardreader. You can enter customer identification information by simply sliding a credit or debit card through the slot.

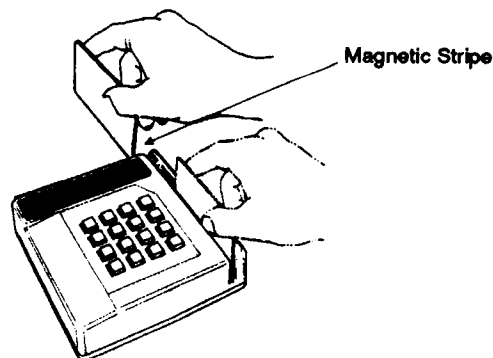

Figure 1-3 TRANZ 330 Cardreader

Place the card at the back of the cardreader slot with the magnetic stripe down and to the right. Slide the card towards you without stopping. The cardreader reads the card data and validates the account number.

Telephone Jacks TRANZ 330 has two modular telephone jacks on its rear panel. You can connect your telephone line to either jack. The second jack allows a standard telephone or another TRANZ 330 terminal to share the same telephone line.

Serial Port TRANZ 330 uses a serial port to communicate with other devices such as a printer, an IBM PC compatible computer, or even another TRANZ 330 terminal. These devices connect to the 8-pin DIN connector on the back of the TRANZ 330 terminal.

PIN Pad/Bar Code Wand Port An additional serial port is provided for a PIN (personal identification number) Pad or a bar code reader. These devices connect to the 6-pin DIN connector on the rear of the TRANZ 330 terminal.

Power Pack Each TRANZ 330 terminal is equipped with a power pack that plugs into a standard 120 volt AC outlet. The cord from the power pack plugs into the power pin on the back of the TRANZ 330 terminal.

Cable Routing Channels The telephone line and power pack cords normally hang from the rear of the TRANZ 330 terminal. However, if you need to hang the cords from the front of the terminal, you can route the cords through special channels molded underneath the TRANZ 330 case.

Optional Printers The TRANZ 330 terminal can operate with four optional VeriFone printers; the slip printer 150, the roll printers 250 and 600, and the combination Printer 500.

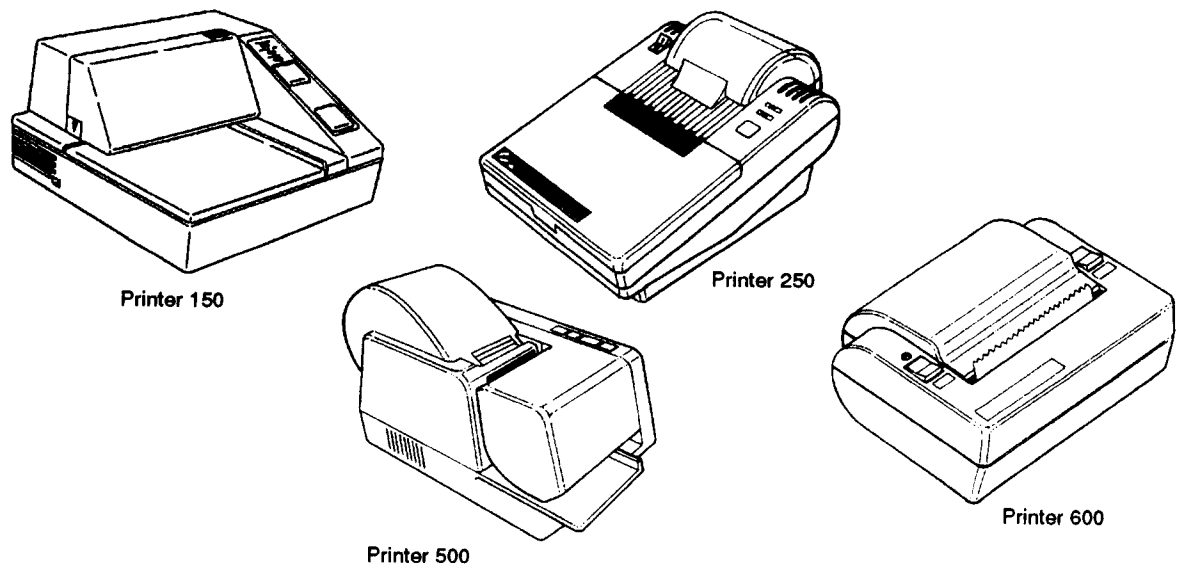

Figure 1-4 Optional Printers

Slip Printer If your TRANZ 330 terminal supports printing, the optional Printer 150 will print receipts and local reports on slip forms. This compact dot-matrix printer prints up to 26 characters per line and accepts forms as thick as five ply.

- Roll Printers** The optional Printer 250 roll printer will print receipts and local reports on rolls of continuous paper. The Printer 250 prints up to 42 characters per line, and accepts 2-ply carbonless and plain roll papers.
- The optional Printer 600 prints on thermal roll paper and features selectable character widths ranging from double width of 20 characters per line, to compressed width with 80 characters per line.
- Printer 500** The Printer 500 can print on paper slips, continuous paper rolls, or both. It features several options for loading paper, configuring print characters, and storing journals and receipts. One model of the printer connects to an optional cash drawer.
- Optional Telephone** An optional telephone is also available from VeriFone. By plugging the telephone into one of the terminal's modular jacks, both the terminal and the telephone can share the same telephone line.
- Internal Modem** A modem (modulator/demodulator), converts electronic data into tones that can be sent great distances over telephone lines. The TRANZ 330 has several internal modem options, all of which provide simple and automatic telecommunications with a host computer.
- Leased-Line Modem (standard)** The Bell 202 modem is the standard internal modem supplied with the TRANZ 330 (202) leased line terminal. It communicates over private leased telephone lines at 1200 baud.
- Bell Modem (standard)** This is the standard internal modem supplied with the TRANZ 330 terminal. The Bell 212A compatible modem communicates over public dial telephone lines. It can operate at 300 or 1200 baud. 1200 baud operation provides faster communications with the host computer.
- CCITT V.21/V.22 (Optional)** Intended for use with international telephone systems, this optional internal modem operates on public dial telephone lines. It can operate in either Bell 212A compatible mode (300 or 1200 baud) or CCITT mode to support V.21 (300 baud) and V.22 (1200 baud) communications.
- Optional Bar Code Wand** Bar codes are a series of vertical lines on a label that identify an item. The code is read by drawing a special wand across the label. The VeriFone bar code wand, shown in Figure 1-5, connects to the PIN Pad/Bar code reader port, located on the rear of the TRANZ 330.

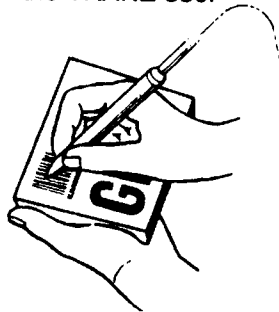
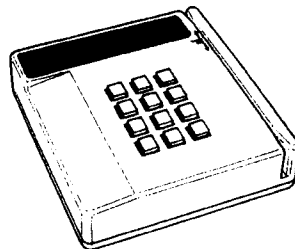

Figure 1-5. VeriFone Bar Code Wand

Optional PIN Pads

The VeriFone PIN Pad 201, shown in Figure 1-6, is a peripheral data entry device that accepts PINs (personal identification numbers) and encrypts the numbers for security purposes. PINs are entered during a retail transaction to verify that a customer is authorized to use the credit card offered. If a customer enters an incorrect PIN, the host computer will not complete the transaction.

The card reader is used to gather account information, and the display panel provides the card holder with prompts, instructions or other information.



PIN Pad 201

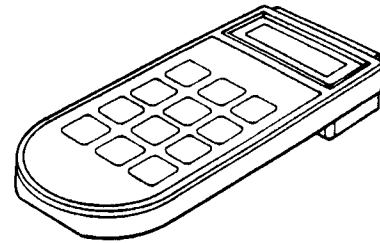

PIN Pad 101

Figure 1-6 VeriFone PIN Pads

The VeriFone PIN Pad 101 is similar in function to the PIN Pad 201 but does not feature a card reader. All PINs are entered manually via the keypad. It connects to a controller that controls all PIN Pad operations and does the actual communicating with the host computer.

The PIN Pad 101 can be wall- or countertop-mounted and removed from its mount for hand-held operations.

2. Installation

Selecting a Location for your Terminal

Select a location for your TRANZ 330 that is convenient for the operator and offers adequate ventilation and protection. In general, avoid areas with:

- excessive heat;
- oil or moisture;
- excessive dust;
- excessive electrical noise (caused by air conditioners, motors, fans, neon signs, or power tools);
- direct sunlight;
- artificial light that could reflect glare off the display panel.

Unpacking

Carefully inspect the shipping carton and its contents for shipping damage. If the TRANZ 330 is damaged, file a claim immediately with the shipping company or carrier and notify VeriFone, Inc. Do not use a damaged terminal.

1. Remove all the items from the carton. You should have:
 - The TRANZ 330 terminal;
 - A telephone line cord;
 - A power pack with a six-foot cord.

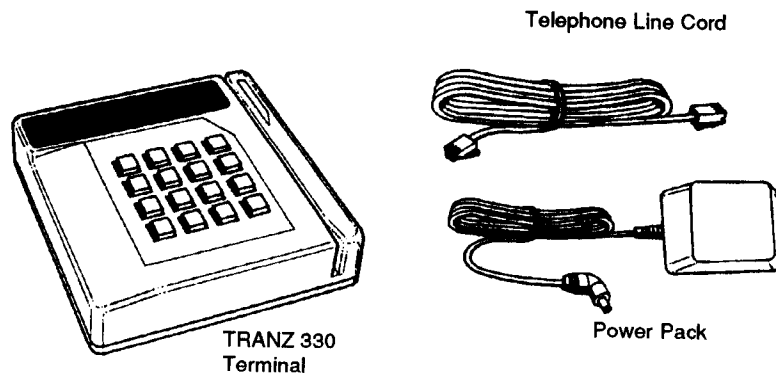

Figure 2-1 TRANZ 330 Components

2. Remove any protective plastic wrapping from the terminal and place all the components on a table or counter top.
3. Remove the plastic strip from the card reader slot. This strip protects the card reader during shipment.
4. Save the carton and packing material for repacking or moving the terminal in the future.

Telephone Line Connection

1. Connect one end of the telephone line cord to one of the two modular jacks on the rear of the terminal. Both jacks perform the same function so it doesn't matter which one you use.
2. Connect the other end of the line cord to your RJ11 type modular telephone wall jack. If you do not have a modular wall jack, obtain an adapter from your local telephone company.

Connecting a Standard Telephone (optional)

1. Connect one end of the telephone's line cord to the unused modular jack on the rear of the terminal.

Note: You must use a fully-operational telephone, not just a handset.

2. If the other end of the cord is not already connected to the telephone, connect it at this time.
3. If your telephone requires additional connections, such as a handset or power supply, refer to the instructions supplied with the telephone when connecting these components.

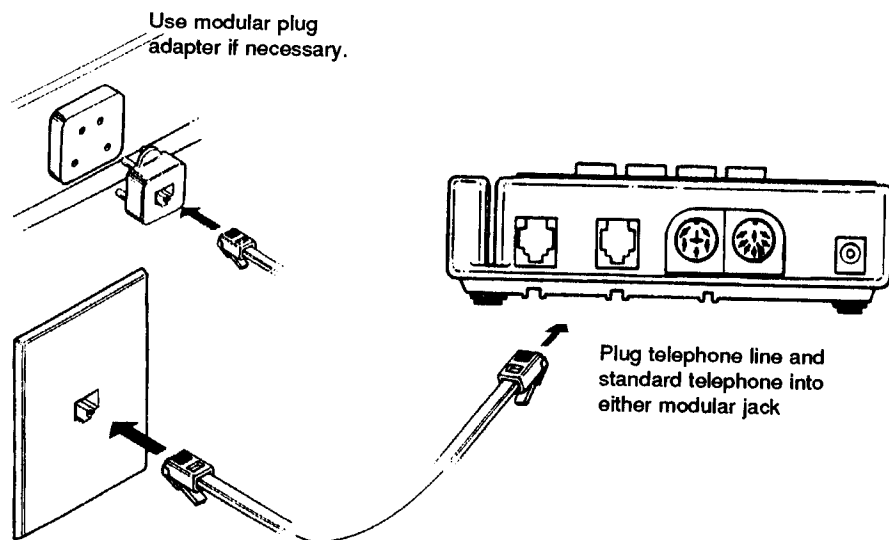

Figure 2-2. Telephone Line Connections

Connecting the Printer 150 (optional)

The VeriFone Printer 150 is a compact slip printer that is ideal for printing receipts, logs, settlement reports and other transaction data on plain paper or forms as thick as 5-ply. The following instructions are for connecting the Printer 150 to the TRANZ 330 terminal. Follow the instructions supplied with the printer for unpacking the printer, inserting paper and ink ribbons, and maintenance. The interface cable to use is VeriFone part number 10465-XX for standard mode or 10392-XX for Printer 100 emulation mode.

Warning: Before installing the Printer 150, be sure the TRANZ 330 terminal is not plugged into a power source.

1. Connect the small plug from the printer power pack to the power connector on the rear of the Printer 150.
2. Remove the ground screw from the rear of the printer. Put the screw through the ground wire lug and screw it back into the printer.
3. Plug the interface cable into the DB25 connector on the rear of the printer. Tighten the thumbscrews to secure the cable to the printer.
4. Plug the other end of the cable into your terminal's RS-232 port.
5. Plug the female connector of the AC power cord into the rear of the power pack.
6. Plug the power cord plug into an indoor, grounded 120 volt AC outlet and turn the power switch on. Do not install or operate the Printer 150 outdoors.

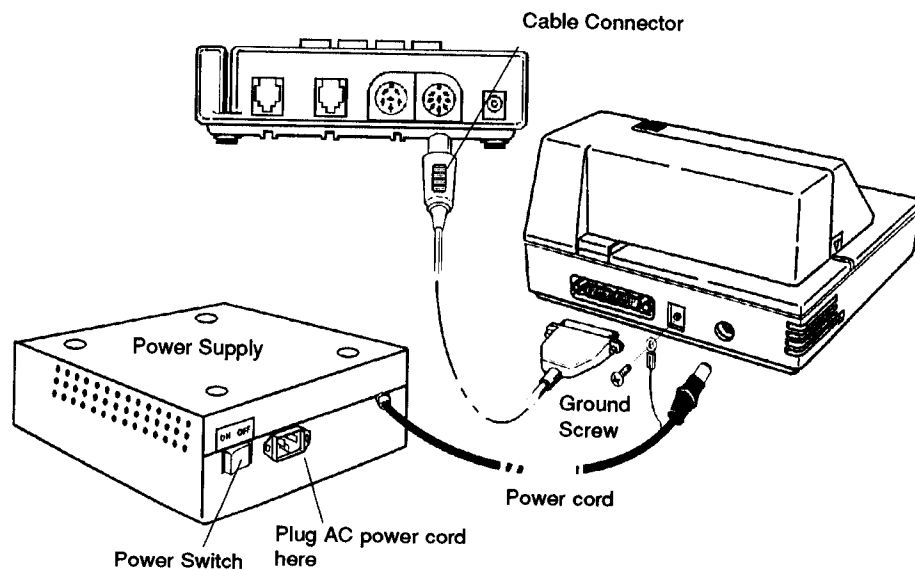

Figure 2-3. Printer 150 Connections

Connecting the Printer 250 (optional)

The VeriFone Printer 250 is a compact roll printer that is ideal for printing receipts, logs, settlement reports and other transaction data on plain roll paper or 2-ply carbonless roll paper. The following instructions are for connecting the Printer 250 to the TRANZ 330. Follow the instructions supplied with the printer for unpacking, inserting paper and ink ribbons and maintenance. The interface cable to use is VeriFone part number 10448-XX (straight connector) or 10454-XX (90-degree connector).

Warning: Before installing the Printer 250, be sure the TRANZ 330 terminal is not plugged into a power source.

1. Connect the 4-pin mini-DIN plug from the printer power pack to the power connector on the right-hand side of the Printer 250 rear panel.
2. Plug the Printer 250 power pack into an indoor, grounded 120 volt AC outlet. Do not install or operate the Printer 250 outdoors.
3. Plug the 8-pin mini-DIN connector on the printer interface cable into the communications port on the left-hand side of the Printer 250 rear panel.

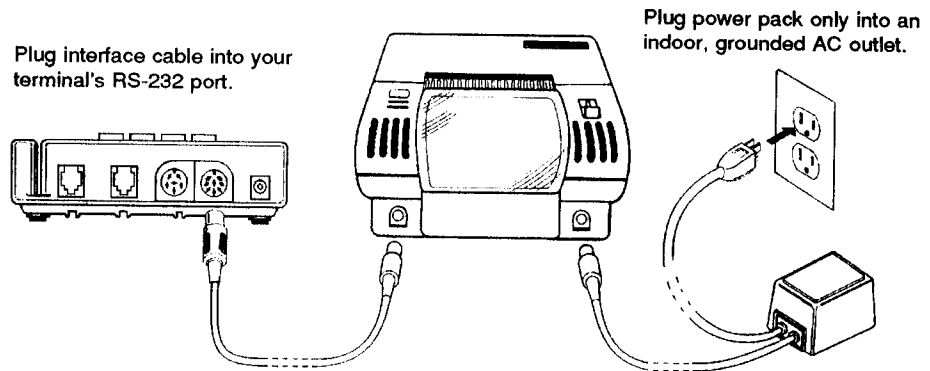

Figure 2-4 Printer 250 Connections

Connecting the Printer 500 (optional)

The VeriFone Printer 500 is a high performance dot-matrix printer for use with VeriFone transaction microcomputers and terminals. It has a connector for an optional cash drawer, several paper feed options and can print on precut paper slips, continuous paper rolls, or both.

Refer to the Printer 500 Installation Guide supplied with the printer for instructions on inserting paper, the ink ribbon cassette, and setting DIP switches. Follow these steps to connect the Printer 500 to a TRANZ 330 terminal.

1. Ensure that both terminal and printer power is turned off.
2. Insert the 8-pin mini-DIN plug on the printer interface cable into the RS-232 connector on the right side of the Printer 500 rear panel.
3. Plug the other end of the cable into the terminal's RS-232 or printer serial port.
4. Insert the 3-pin mini-DIN plug from the printer power pack into the power connector on the left side of the Printer 500 rear panel.
5. If your power pack has a separate removable AC power cord, plug the cord into the power pack.
6. Insert the male plug on the AC power cord into a grounded, indoor 120 volt AC outlet.

WARNING: Do not plug the power pack into an outdoor outlet or operate the printer outdoors.

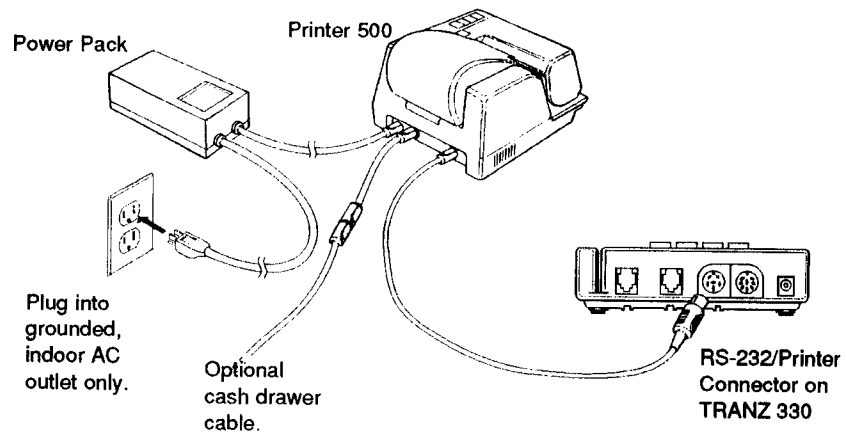

Figure 2-5. Printer 500 Connections

Connecting the Printer 600 (optional)

The VeriFone Printer 600 is a very economical thermal dot-matrix printer that can be used with VeriFone transaction microcomputers and terminals and can operate on both horizontal or vertical surfaces. Follow the Printer 600 Installation Guide instructions supplied with the printer for inserting the thermal paper roll, setting the DIP headers, and mounting the printer vertically. The following instructions are for connecting the Printer 600 to the TRANZ 330.

CAUTION: Unplug the terminal's power pack before connecting the printer.

1. Plug the 8-pin mini-DIN connector on the printer interface cable into the RS-232 connector on the left-hand side of the Printer 600 rear panel.
2. Plug the other end of the cable into your terminal's RS-232 or printer port.
3. Plug the Printer 600 power pack into an indoor, 120 volt AC outlet.
4. Plug the end of the power pack cord into the power connector on the Printer 600.

CAUTION: Do not use an outdoor outlet or operate the Printer 600 outdoors.

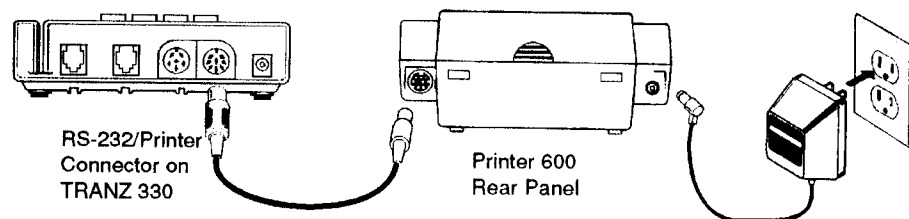

Figure 2-6. Printer 600 Connections

Connecting the Bar Code Wand (optional)

1. Connect the plug on the bar code wand to the PIN Pad/Bar Code port on the rear of the TRANZ 330 terminal, as shown in Figure 2-7.

Warning: Before connecting the bar code wand, be sure the TRANZ 330 terminal is not plugged into a power source.

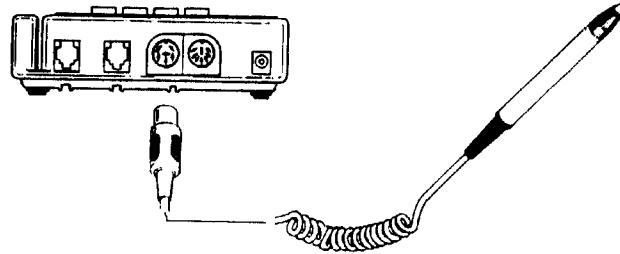

Figure 2-7. Bar Code Wand Connection

Connecting the PIN Pad 201 (optional)

1. Connect the modular plug on the PIN pad cable to the modular jack on the rear of the PIN pad.
2. Connect the 6-pin DIN plug on the other end of the cord to the PIN Pad/Bar Code port on the rear of the TRANZ 330 terminal.

Warning: Before connection the PIN Pad, be sure the TRANZ 330 terminal is not plugged into a power source.

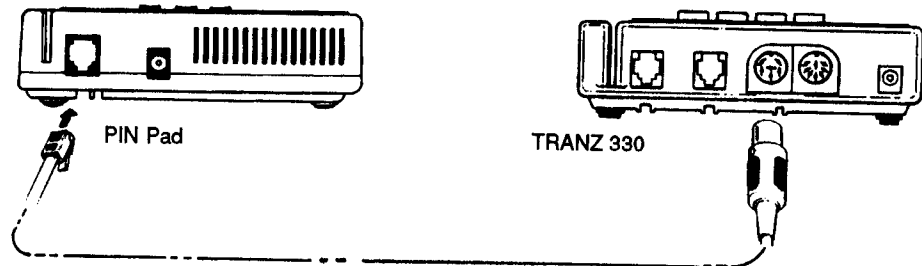

Figure 2-8 PIN Pad 201 Connections

Connecting the PIN Pad 101 (optional)

WARNING: Unplug the TRANZ 330 power pack before connecting the PIN Pad.

The PIN Pad 101 rear panel has a modular, 4-wire interface port for power and communication connection to the TRANZ 330 terminal.

1. Connect the modular plug on the PIN Pad cable to the modular jack on the rear of the PIN Pad.
2. Connect the other end of the cable to the PIN Pad port on the rear of the terminal.
3. Spread the grommet open and put it on the cord with the narrow end facing the PIN Pad.
4. Slide the grommet up the cord and push its narrow end into the modular jack. When properly installed, the grommet should fit flat against the rear of the PIN Pad.

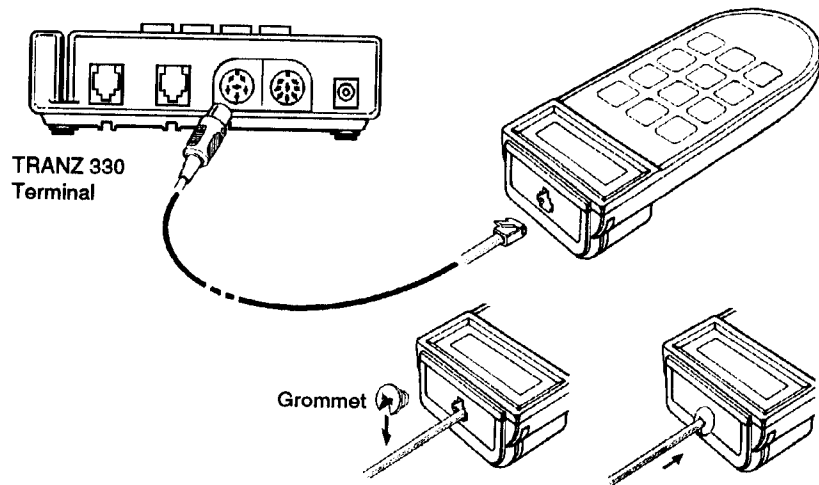

Figure 2-9. PIN Pad 101 Connections

Connecting the Terminal Power Pack

1. Attach the small plug on the power pack cord to the power pin on the rear of the terminal.
2. Plug the two-prong AC connector from the power pack into an indoor 120 volt AC outlet.

Warning: Do not plug the power pack into an outdoor outlet or operate the TRANZ 330 terminal outdoors. Disconnecting the power source during processing may cause program corruption and/or loss of data capture files.

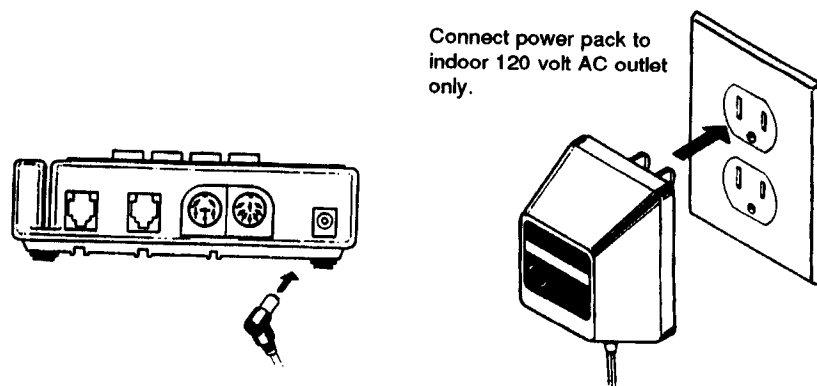

Figure 2-10. Power Pack Connections

Routing Cords in the Cable Channels (optional)

The cable routing channels, located underneath the terminal, allow you to hang the power and modular line cords from the front of the terminal instead of the rear.

1. Turn the TRANZ 330 terminal upside down and locate the cable channels. (See Figure 2-11.)
2. Insert a section of each cable into the channel closest to the cable plug. Be sure that the cords are straight and nested securely in the channels.
3. Turn the terminal right side up and place it back in its original position with the cords neatly out of the way.

Insert cords in these channels.

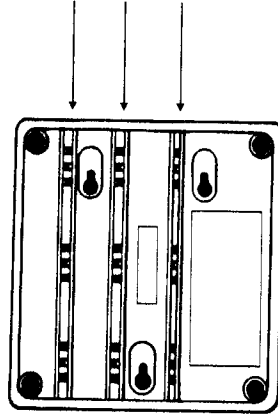

Figure 2-11 Cable Routing Channels

3. Downloading

TRANZ 330 Downloading

Before you can fully operate the TRANZ 330, its memory must contain both application code and parameter data. Application code provides the instructions the terminal needs to perform its operations and to respond to different events as they occur.

Parameter data is additional information specific to a terminal, host computer or merchant. Examples of parameter data include the terminal serial number, host computer phone number and the merchant identification number.

Because application code is usually lengthy, it should rarely be entered from the terminal's keypad. Instead, applications are transferred from a download computer or another terminal. Parameter data can be entered from the keypad, or it can be easily downloaded like application code.

Terminal-to-Terminal Direct Download

This is the fastest and simplest download method. Terminal-to-terminal downloads involve copying all the information from the memory of one terminal (master) into the memory of another terminal (slave). This results in two terminals with exactly the same information in each memory location. Because this method can transfer data at 19,200 baud (up to 64 times faster than telephone downloads), VeriFone recommends using terminal-to-terminal downloads in locations that have more than one TRANZ 330 terminal.

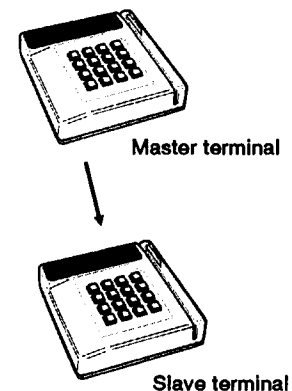

*Figure 3-1 Terminal-to-Terminal
Download*

Before using this download method, you must have a "master" terminal with all of the application code and parameter data already stored in its memory. Use telephone downloading if you need to create a master terminal. The following instructions describe how to perform a terminal-to-terminal download. You will need a download cable (VeriFone part number 00490-00) for this procedure.

Master/Slave Considerations

The TRANZ 330 sending the information is called the master terminal; the other TRANZ 330 receiving the information is called the slave terminal.

Terminal-to-terminal downloads completely replace the memory in the slave terminal. You must manually enter the data in those memory locations specific to an individual terminal.

For example, memory location 001 is reserved for a terminal's serial number. If the number is not changed, this memory location will contain the serial number of the master terminal instead of the slave terminal.

Usually only the terminal's serial number will have to be changed. However, refer to your application reference manual to see if any other memory locations are affected by the download. Use the STORE or RECALL functions as described in Section 5 to change individual memory locations.

1. Connect one end of the terminal-to-terminal download cable to the 8-pin DIN connector (printer port) on the back of the master terminal.
2. Connect the other end of the cable to the 8-pin DIN connector on the back of the slave terminal.

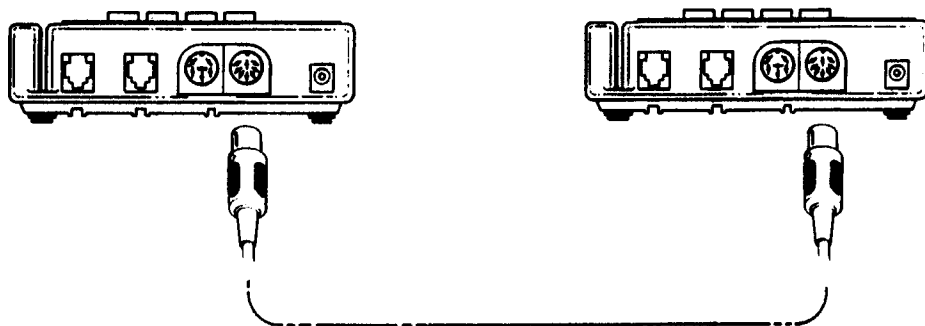

Figure 3-2 Terminal-to-Terminal Connections

3. Use the terminal's displayed prompts as a guide for the following procedure to download the application code and parameter data.

On the master terminal:

Display	Response
1. (idle prompt)	On the master terminal, press [FUNC/ENTER].

	Display	Response
	2. FUNCTION?	<p>Press [*] on the master terminal.</p> <p><i>Note: If memory location 017 contains a non-zero number, the memory will be password protected. You will be required to enter the system password before proceeding with the download. This is a feature designed to prevent unauthorized access to the data stored in the terminal.</i></p> <p><i>If memory location 017 contains a zero, the password is not required and you can proceed to step 10.</i></p>
	3. ENTER PASSWORD?	<p>Enter the system password to unlock memory information. The system password supplied with each terminal is Z66831 (press: [1] [ALPHA] [ALPHA] [6] [6] [8] [3] [1]). However, if you or the application programmer have already created a new password, enter the new password instead.</p>
	4. *****	<p>The terminal will display an asterisk for each key entered. After entering the complete password, press [FUNC/ENTER].</p>
	5. UNIT SEND	<p>The display panel will show UNIT SEND to indicate that the master terminal is ready to download to the slave terminal.</p>
On the slave terminal:	6. (idle prompt)	<p>Press the slave terminal [FUNC/ENTER] key.</p>
	7. FUNCTION?	<p>Press [#] on the slave terminal. The slave terminal will momentarily display UNIT RECEIVE indicating that it is ready to receive the information from the master terminal.</p> <p><i>Note: If memory location 017 contains a non-zero number, the memory will be password protected. You will be required to enter the system password before proceeding with the download. This is a feature designed to prevent unauthorized access to the data stored in the terminal.</i></p> <p><i>If memory location 017 contains a zero, the password is not required and you can proceed to step 10.</i></p>

TRANZ 330 Reference Manual

	Display	Response
	8. ENTER PASSWORD?	Enter the system password to unlock memory information. The system password supplied with each terminal is Z66831 (press: [1] [ALPHA] [ALPHA] [6] [6] [8] [3] [1]). However, if you or the application programmer have already created a new password, enter the new password instead.
	9. *****	The terminal will display an asterisk for each key entered. After entering the complete password, press [FUNC/ENTER].
On both terminals:	10. UNIT SENDING UNIT RECEIVING	Shortly after the UNIT RECEIVE message is displayed, the master terminal will display UNIT SENDING. The slave terminal's display will change to UNIT RECEIVING.
	11. SUCCESSFUL	When the download is complete, both terminals will display the SUCCESSFUL prompt indicating the download was a success. Press the [CLEAR] key on both terminals to display the idle prompt.

Direct PC Downloads

A direct PC download requires an IBM PC or compatible computer and ZONTALK or TCLOAD, proprietary software downloading programs developed by VeriFone.

A direct PC download uses a cable to transfer information directly from a PC to your TRANZ 330 terminal. The application code must be present on the PC. In addition, you will need the special download cable (IBM-PC version VeriFone part number 00446-05; IBM-AT version VeriFone part number 00446-04).

Refer to the ZONTALK or TCLOAD Reference Manual for specific instructions for connecting your TRANZ 330 terminal to the PC and performing a direct download.

Note: Since you cannot download parameter data with a direct PC download, you must either download this data with a telephone download, enter the data manually with the keypad using the STORE or RECALL functions as described in Section 5 or use a terminal-to-terminal direct download, described earlier in this section.

Telephone Download

If you do not have a PC running ZONTALK or TCLOAD at your location, you will have to call a remote download computer to request a download. Many TRANZ 330 terminals in the field receive application code and parameter data via telephone download.

With telephone downloading, you can choose either a full or partial download. A full download sends all application code and parameter data. A partial download sends only the data needed to upgrade the application or parameters already in a terminal. This is faster than completely replacing all of this information in your terminal. The contents of a partial download are determined by the ZONTALK software. However, if you do not have any application code, or if you are not sure if you do, request the full download.

When telephone downloading, TRANZ 330 terminals (versions 2.0 and greater) will prompt you for the correct data if there is nothing programmed in the following memory locations.

Memory

Location	Information
----------	-------------

000	Download computer's telephone number.
001	TRANZ 330 terminal serial number. This number is located on the bottom of the terminal.
019	Application ID number. Obtain this number from the person responsible for maintaining the application files in the download computer.
960	Speed selection. This memory location should contain a "2" for 1200 baud communication or a "1" for 300 baud communication. The speed selected must match the speed used by the download computer.

Download Prompts for Empty Memory Locations

The procedure for entering any of the above locations during a download is as follows:

Display	Response
1. (idle prompt)	Press [FUNC/ENTER]
2. FUNCTION?	Press [0].
2. DOWNLOAD?	Press [FUNC/ENTER]
3. DWNLD PHONE NUM? SERIAL NUM? APPLICATION ID? DNLD SPEED?	The TRANZ 330 will prompt you if any of the four memory locations are empty. Enter the phone number, serial number, application ID and download speed as necessary.

Continue with Step 4 on page 3-6.

On TRANZ 330 versions less than 2.0, you must verify the above memory locations are not empty prior to performing a telephone download. Use the RECALL function described in Section 5 to examine the data in these memory locations and to enter the correct information.

Caution: If the download computer is using ZONTALK version 2.31 or earlier and you enter the incorrect serial number or application ID, the download computer will cancel the download and clear all memory locations. If this occurs, use the RECALL or STORE function to enter the correct phone number, serial number, and application ID and try again.

Telephone Download Procedure

Display	Response
1. (idle prompt)	Press [FUNC/ENTER].
2. FUNCTION?	Press [0].
3. DOWNLOAD?	<p>If you want a complete download of application code and parameter data, press [FUNC/ENTER].</p> <p>If you want a partial download, press [*].</p>
4. DIALING	<p>Wait - the terminal is dialing the download computer.</p> <p>If the terminal displays WAITING FOR LINE, check the telephone line cord connection. If the cord is properly connected, the line may be busy. Press [CLEAR] to abandon the call, or wait until the line is free.</p>
5. WAITING FOR ANSR	The terminal is waiting for the download computer to answer.
6. COMMUNICATING	<p>Wait - The download computer is sending the requested data to your terminal.</p> <p><i>Note: If the remote download computer cannot locate your terminal's serial number in its data base, the prompt SERIAL # NOT FND will be displayed. Press [CLEAR] to cancel the download, check memory location 001 and try again. If the problem persists, contact the person responsible for maintaining the download computer.</i></p>
7. DOWNLOAD DONE	<p>The terminal successfully completed the download. Press [CLEAR] to return to the idle prompt.</p> <p>If UNSUCCESSFUL DL appears instead, the terminal was unable to complete the download. This could be due to bad telephone lines or other problems not related to the terminal.</p> <p>Press [CLEAR] and try the download procedure again. If the problem persists, contact the VeriFone Customer Hot Line.</p>

BuyPass Download

Certain TRANZ 330 terminals, Eproms 3D2AU210, 3D2CU210, and 3D2EU340 support BuyPass downloads which allow for a set of keystrokes other than what is used in ZONTALK. To access this feature, follow the instructions below:

Display	Response
1. (idle prompt)	Press [FUNC] and [0].
2. DOWNLOAD?	Press either [1] or [2]. [1] = full download [2] = partial download
3. DWNLD PHONE NUM?	Enter the download phone number.
4. MERCHANT ID?	Enter the merchant ID number.
5. DIALING WAITING FOR ANSWER COMMUNICATING DOWNLOAD DONE	Wait until the download's done.

4. How the TRANZ 330 Works

Host Transactions

This section will give you an overview of the TRANZ 330 capabilities and how its different functions work. More detailed operational information can be found in your application manual.

The TRANZ 330 operates as a basic transaction computer with pre-programmed prompts for banking applications. It is intended to communicate with a host computer, which is typically located at a financial institution or a company's data processing center. Host computers can store and process large amounts of data, including a customer's account history. By communicating with the host computer, usually over telephone lines, the TRANZ 330 puts this vast data base at the terminal operator's fingertips. The host computer notifies the terminal operator whether or not a transaction can be authorized.

The TRANZ 330 terminal can be programmed to perform up to nine different transactions with remote host computers. The specific transactions available are determined by the application program downloaded to the terminal.

A typical host transaction involves dialing the host computer, providing the host computer with information about the terminal and the customer, and receiving authorization to complete the transaction.

One transaction key is reserved for each type of transaction used by each host computer. For example, if you use three different transactions for each of three different host computers, you will need all nine transaction keys.

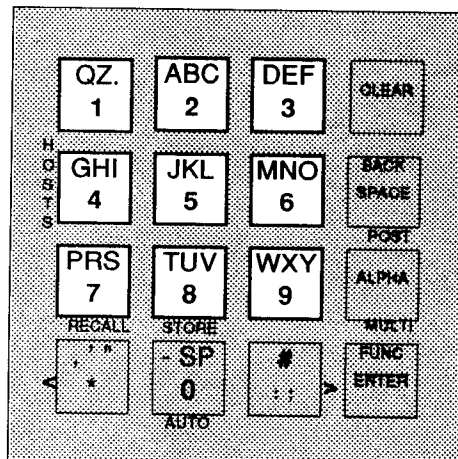

Figure 4-1 TRANZ 330 Host Keys

Local Functions

Unlike host computer transactions, local functions are performed only at the terminal and do not require communications with a host computer. In fact, most local functions can be performed, even when the phone line is disconnected or busy.

The TRANZ 330 can perform several different local functions. Some of these functions are standard for all terminals. Up to seven custom local functions (also called local transactions) can be programmed for your application and performed from the keypad. However, the actual number of local functions available to the user depends on how many were programmed into the application.

The local functions available vary with each application. However, some typical local functions may include the following. Refer to your application reference manual for information on the local functions available to you.

- calculating batch totals;
- storing user identification information;
- listing different transactions previously stored in the terminal;
- date and time calculation; and
- printing transaction data or other information.

Applications

The way a TRANZ 330 terminal operates and the procedures it follows is determined by its application (also called application program). An application is a series of instructions electronically stored (programmed) in the terminal's memory. These instructions direct the terminal to perform specific operations and to respond properly to different events as they occur.

Each TRANZ 330 terminal is supplied with the same standard application. However, to meet the specialized needs of a company, many terminals are programmed with a custom application.

Standard Application

Although each TRANZ 330 is initially programmed with a standard application, this application is only accessible on terminals that do not have a custom application already loaded into them. The standard application allows the user to access many of the services offered by several host computers. This is often sufficient for handling the needs of many companies. However, because the standard application may not meet all of the specialized needs of some companies, many TRANZ 330 terminals are programmed with a custom application.

Custom Applications

Custom applications help make the terminal work within a company's existing operations rather than forcing a company to change transaction procedures to work with a terminal.

These applications can specify how host computer transactions will be performed and how extensive security and fraud control measures will be. If other devices, such as a printer, are used with the terminal, a custom application can precisely determine the procedures and formats for entering and printing information with these devices.

Programming a Custom Application

Custom applications are created by programmers using the VeriFone Terminal Control Language (TCL). TCL programming is typically performed on an IBM PC or compatible computer. When the application is completed, it can be sent from the computer to the terminal using a process called downloading. The downloading process transfers the application to the terminal and stores it electronically in the terminal's memory. See Section 3 for downloading information.

Programming with the Keypad

The TRANZ 330 keypad can be used to quickly modify part of an application program or to update some of the data stored in the terminal's memory (such as a host computer telephone number). However, creating an entire application is always done on personal computers. These computers have more memory and more keys which make them better equipped for typing and editing application codes.

RAM and ROM Memory

Application code, parameter data and system firmware (codes permanently programmed into the terminal at the factory) all reside in the terminal's electronic memory. There are two different types of electronic memory in each TRANZ 330 terminal - Random Access Memory and Read Only Memory. Random Access Memory, or RAM, is used to store information that can be easily acquired and modified. Because this memory is readily changed, it is useful for storing custom applications, temporary data entered from the keypad or card reader, phone numbers, the date and time, and other information that may be subject to change from time to time.

Because RAM is also temporary, the built-in battery provides backup power to preserve data in RAM in the event of a power failure.

Read Only Memory, or ROM, is factory installed with each TRANZ 330 terminal. This information is permanent and cannot be changed by the user or application programmer. Because it cannot be changed, ROM is ideal for safely storing the operating system firmware which controls the different components of the terminal and allows the downloading and use of custom applications. The standard application found in all TRANZ 330 terminals is also stored in ROM.

Memory Locations

RAM memory is divided into segments called memory locations. Some memory locations are dedicated to specific functions. For example, memory location 001 is reserved for the terminal's serial number and location 004 is reserved for the current date. Other memory locations are general purpose locations which can be used for a variety of functions.

Because RAM memory locations are temporary, the information they contain can be changed at any time. However, for security reasons, these locations can be password protected to prevent unauthorized tampering.

Caution: Do not alter the information in TRANZ 330 memory locations unless you fully understand what you are changing. Your terminal will not be able to function properly unless the locations contain valid data.

Terminal Parameters

A terminal parameter is information that relates to the terminal itself. The following Table 4-1 lists the different parameters that may be used by your application. However, the actual parameters used depends on the application programmed in your terminal. Each parameter is explained in more detail in Section 6.

Table 4-1 Terminal Parameters

Memory Location	Parameter
000	Remote Download Computer Phone Number
001	Terminal Serial Number
004	Program Date
005	Message Sequence Number
006	Scroll Length
007	Multiple Transaction Timeout
009	Terminal Key Beep
010	Dial Type
011	Dial Speed Flag
012	Parallel Phone Available Flag
013	Number of Attempts
014	Telephone Line Test
017	RECALL, Set Clock and Unit-to-Unit Restriction
019	Application ID
038	Auto Answer Control String
030	Idle Prompt
950	Printer Type
951	Printer 200 Paper Advance
960	Dial-Up Line Upload/Download Speed
970	PIN Pad/Bar Code Wand Port Function
975	Line Recovery Time
981	Idle Loop Control String
985	Host # for Card Transactions
986	Host # for Bar Code Transactions

Transaction Parameters

Each transaction requires a set of parameters before the transaction can be performed on a TRANZ 330 terminal. For example, the host computer phone number must be stored in the correct memory location before the terminal can dial the host computer.

Once the necessary parameters are stored, the terminal will automatically execute the transaction when the associated transaction key is pressed.

Because the TRANZ 330 can accommodate up to nine different transactions, memory locations are reserved for nine different sets of parameters.

Table 4-2 on the next page lists the different parameters that may be required for a transaction with a host computer. However, the actual parameters used depends on the requirements of a particular transaction.

Table 4-2 Transaction Parameters

Memory Location	Parameter (X = transaction keys 1-9)
X00	Primary Phone Number
X01	Secondary Phone Number
X02	Call Center Phone Number
X03	Referral Card Phone Number
X04	Merchant (Terminal) ID
X05	Transaction Format Flag
X06	Fraud Control Flag
X07	Transaction Control String
X08	Transaction Type Prompt
X09	Floor Limit
X10	Response Analysis Control String
X11	Auxiliary Control String
X12	Multiple-Transaction Group Code
020-029	Login Strings 0 through 9

Note: Each of the nine transaction keys has its own set of parameters. For example, the merchant ID memory location for transaction key "2" is 204. For key "3," the merchant ID memory location is 304.

Multiple Transactions

TRANZ 330 can perform multiple transactions on a single dial up. Multiple transactions are performed back-to-back; when one transaction is finished, the operator starts the next one until all transactions are completed. This feature, when supported by the host computer, speeds up transactions by reducing the number of times the terminal dials up the host computer.

Networks

TRANZ 330 permits communications with several separate networks. Networks help callers reach a remote computer that cannot be easily accessed by direct telephone connection. The network receives a call from the terminal and routes the call to the desired host computer.

For example, if transaction key [3] is programmed to access a host via a network, pressing [3] would cause the terminal to dial the network's telephone number. The network would in turn route the call to the host computer.

To the user, the network is invisible. The only noticeable difference may be a slightly slower transaction speed. Eleven networks currently supported by the TRANZ 330 are:

- Tymnet
- Compuserve
- Telenet
- Geisco
- Nabanco/Western Union
- Busycomm
- Datapac (Canada)--no parity
- Autonet
- Connet
- Datapac--even parity
- Western Union

5. Basic Operation

This section describes how to perform some of the basic operations of the TRANZ 330 terminal. These operations are used with the standard application supplied with each terminal. However, because actual operations may vary in custom applications, refer to your application manual if you are not using the standard application.

Startup

The TRANZ 330 will start up automatically as soon as it is plugged into its power source. The terminal will first display "TRANZ 330" followed by the firmware version number. The terminal will then display the application ID number (if available) followed by the idle prompt. The idle prompt indicates the terminal is ready for operation.

The standard application's idle prompt is the day of the week, date, and time. For example: THU 7/23 10-18 A (Thursday, July 23, 10:18 a.m.).

Host Transaction Keys

The nine alphanumeric keys (labeled 1 through 9) are also known as the host transaction keys and perform operations requiring communication with a host computer.

1. Check the display for the idle prompt. If it is not displayed, press [CLEAR] to cancel the current operation and display the idle prompt.
2. Press the desired host transaction key to begin the transaction.
3. Follow the instructions given by the prompts on the display panel. These prompts help provide the host computer with information needed to complete the transaction.
4. When the transaction is finished, press [CLEAR] to display the idle prompt.

Note: These keys can also be used for local functions when [FUNC/ENTER] is pressed first. Refer to Section 4 for more information.

Using the Cardreader

The cardreader saves time and avoids the mistakes that can occur when manually entering information from the keypad.

1. Check the display for the idle prompt. If it is not being displayed, press [CLEAR] to end the current operation and return to the idle prompt.
2. Insert the credit or debit card into the rear of the card reader slot with the magnetic stripe facing down and to the right of the terminal. (See Figure 5-1.)

- Without stopping, slide the card briskly through the slot.
If the terminal beeps, check the position of the magnetic stripe, and slide the card through the slot again. If the beep persists, the card may be damaged. Manually enter the account number from the keypad.

- Complete the transaction following the displayed prompts.

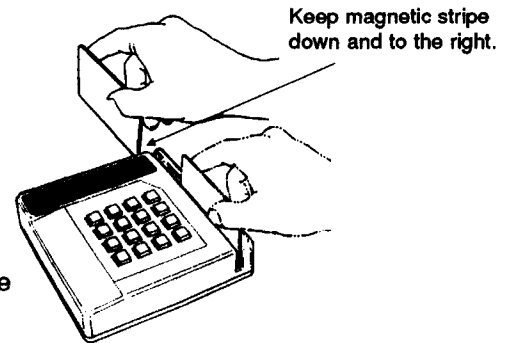

Figure 5-1 Cardreader Operation

Note: Some transactions are initiated by pressing a transaction key first and then sliding the card through the slot. If a host key is not pressed before a transaction, the terminal will use the host key as defined by memory location 985 (default is key 1). Refer to your application manual for more details.

Using the Optional Bar Code Wand

The optional bar code wand can be used with terminals without a built-in bar code reader or for bar code labels that cannot fit through the card reader.

To use the wand, simply draw the tip of the wand smoothly across the entire bar code.

Memory Dialing

The memory dial feature, also known as auto dial, is used to automatically dial phone numbers stored in the TRANZ 330 memory. To use this feature, you must have a standard telephone connected to the terminal and at least one phone number stored in the terminal's memory.

Display	Response
1. (idle prompt)	Press the [0/AUTO] key.
2. MEMORY DIALER	Enter the three-digit memory location number that contains the desired phone number. Instructions for creating memory dial phone numbers are found in Section 6 "Entering Terminal Parameters."
3. (memory location and phone number)	The terminal will show the memory location and the phone number it contains and then dial the phone number.
4. PICK UP HANDSET	Pick up the telephone handset to complete the call. To cancel a call before the connection is made, press [CLEAR].

Entering Alphanumeric Data From the Keypad

The TRANZ 330 keypad has 16 keys; twelve of these keys can be used to enter as many as 47 different alphanumeric characters. These characters are the letters A through Z, the numerals 0 through 9 and the following special characters: +* , ' " - . # : ; @ and [space].

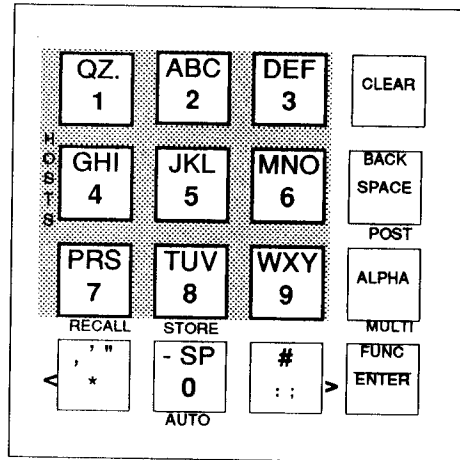

Figure 5-2 TRANZ 330 Keypad

Just as the [SHIFT] key on a typewriter selects one of two different characters assigned to a single key, the [ALPHA] key on the terminal selects the different characters available per key.

Press the key containing the character and then press the [ALPHA] key as many times as required to display the correct character.

Note: The terminal must be in a mode that allows data entry, such as the STORE or RECALL modes, before information can be entered from the keypad.

The following examples in Table 5-1 demonstrate how to enter the characters 2, A, B, and C using the [2] key and the [ALPHA] key.

Table 5-1 Entering Alphanumeric Data

Desired Character	Keys to Press
2	Press the [2] key.
A	Press the [2] key. Press the [ALPHA] key once.
B	Press the [2] key. Press the [ALPHA] key twice.
C	Press the [2] key. Press the [ALPHA] key three times.

The following table lists the different characters available from the keypad and how to access these characters.

Table 5-2 TRANZ 330 Alphanumeric Characters

Key to Press	Without Pressing [ALPHA] Key	Press [ALPHA] Key One Time	Press [ALPHA] Key Two Times	Press [ALPHA] Key Three Times
1 QZ.	1	Q	Z	.
2 ABC	2	A	B	C
3 DEF	3	D	E	F
4 GHI	4	G	H	I
5 JKL	5	J	K	L
6 MNO	6	M	N	O
7 PRS	7	P	R	S
8 TUV	8	T	U	V
9 WXY	9	W	X	Y
0 -SP	0	-	(space)	+
* ,"	*	,	'	"
# ;@	#	:	;	@

Using the STORE Function

The STORE function allows you to store data in a single memory location. If data is already stored in that location, the STORE function will replace the existing data with the new data.

To prevent unauthorized manipulation of the data stored in the terminal, the system password is required before the STORE function can be used.

The following steps describe how to use the STORE function.

Display	Response
1. (idle prompt)	Press [FUNC/ENTER].
2. FUNCTION?	Press [8/STORE].
3. PASSWORD?	Enter the system password to unlock memory. The system password supplied with each terminal is Z66831 (press: [1] [ALPHA] [ALPHA] [6] [6] [8] [3] [1]). However, if you or the application programmer have already created a new password, enter the new password instead.

Display	Response
4. *****	The terminal will display an asterisk for each key entered. After entering the complete password, press [FUNC/ENTER].
5. STORE WHAT?	Enter the three-digit memory location number (000 through 999) where you want to store the data. For example, to store the telephone number of a remote download computer, enter 000, which is the memory location for the telephone number.
6. (memory location) =	The memory location number you entered will be displayed. Now enter the data you want to store in the memory location. For this example, enter the telephone number of the remote download computer.
7. (memory location) = (data)	The memory location number plus the data you just entered will be displayed. If you make any errors, press [BACKSPACE] to erase them. Then reenter the correct data. Press [FUNC/ENTER] to complete the entry.
8. STORE WHAT?	To select the next memory location to be modified, follow steps 5 through 7. To exit the STORE function, press [CLEAR]. <i>Caution: Once the terminal's memory has been unlocked, it will remain unlocked until the unit is powered down and started up again or a host transaction key (1-9) is pressed.</i> <i>To ensure the memory is locked after using the STORE function, press one of the host transaction keys (1-9) after the idle prompt and then immediately press the [CLEAR] key. This will lock the memory so it cannot be changed until the password is entered again.</i>

Using the RECALL Function

The RECALL function displays and changes data stored in a memory location. For example, to look up the current download computer telephone number, use the RECALL function to display the contents of memory location 000.

Displaying Information

The following steps describe how to use the RECALL function to display information.

Display	Response
1. (idle prompt)	Press [FUNC/ENTER].
2. FUNCTION?	Press [7/RECALL]. <i>Note: If memory location 017 contains a non-zero number, the system password will be required before data can be displayed. This is a feature designed to prevent unauthorized access to the data stored in the terminal. If memory location 017 contains a zero, the password is not required and you can proceed to step 5.</i>
3. PASSWORD?	Enter the system password to unlock memory information. The system password supplied with each terminal is Z66831. However, if you or the application programmer have already created a new password, enter the new password instead.
4. *****	The terminal will display an asterisk for each key entered. After entering the complete password, press [FUNC/ENTER].
5. RECALL WHAT?	Enter the desired memory location number (000 to 999) of the data you wish to see. For example, to see the telephone number of a remote download computer, enter 000.
6. (memory location) = (data)	The terminal will display the number of the memory location and the data it contains. You now have the following options: <ul style="list-style-type: none">To view the data in the next memory location, press [FUNC/ENTER].To view the data in the previous memory location press [ALPHA].If the entire contents of a memory location does not fit on the display panel, use the scroll keys [*] and [#] to view the additional characters.To exit the RECALL mode, press [CLEAR].If you want to add or change the data, follow steps 7 through 9.

Adding and Changing Information

Follow these steps when using the RECALL function to change the information in a memory location.

Display	Response
7. (memory location) = (data)	If the desired memory location is not displayed, use the RECALL function to display the contents of the memory location. Press [BACKSPACE].
8. PASSWORD?	You must unlock the memory with the system password before you can change the contents of the memory location. The password is required even if you entered it previously in step 3.
9. (memory location) =	Enter the new data for the memory location.
10. (memory location) = (data)	The memory location number plus the data you just entered will be displayed. If you make any errors, press [BACKSPACE] to erase them. Then reenter the correct data. Press [FUNC/ENTER] to complete the entry.

Caution: Once the terminal's memory has been unlocked, it will remain unlocked until the unit is powered down and started up again or a host transaction key (1-9) is pressed.

To ensure the memory is locked after using the RECALL function, press one of the host transaction keys (1-9) after the idle prompt and then immediately press the [CLEAR] key. This will lock the memory so it cannot be changed until the password is entered again.

Using the Multiple Transaction Function

The multiple transaction feature enables you to perform more than one transaction during a single call to a host computer that supports this feature. As soon as one transaction is completed, the terminal stays on the line and waits for you to select the next transaction. Because numerous phone calls are eliminated, performing multiple transactions is faster than performing the transactions separately.

Before you can perform multiple transactions, the following requirements must be met.

1. The host computer must be capable of performing multiple transactions.
2. The multiple transaction timeout period must be set in memory location 007. To view the contents of memory location 007, refer to "Using the RECALL Function" in this section.
3. All of the transactions used in a multiple transaction operation must use the same host computer. A special multiple transaction group code identifies the host computer assigned to a transaction. For example, if one host computer processes the transactions initiated by keys [1], [2] and [3], all three keys would have the same transaction group code.

You can view the transaction group number in memory locations X12 (X = the host transaction key numbers 1-9). For more information on entering transaction group codes, refer to Section 7 in this manual.

After the above conditions are met, use the following procedure to perform multiple transactions.

Display	Response
1. (idle prompt)	Press the [ALPHA/MULTI] key.
2. MULTI TRANS	Press the desired host transaction key to perform the first transaction. When the transaction is completed, the final response message will remain on the display panel. Press another host transaction key to initiate the next transaction. It must use the same host computer and belong to the same transaction group as the previous transaction. Press [CLEAR] to display the idle prompt after the last transaction is completed. <i>Note: If you do not press the [CLEAR] key, the terminal will automatically end the operation when the multiple transaction timeout is reached.</i>

Using the POST Function

When using the TRANZ 330 standard application, the terminal automatically dials the selected host computer as soon as a host transaction key is pressed. This auto dial feature saves time by permitting you to enter transaction data from the keypad or cardreader while the terminal is dialing the host computer.

However, for transactions requiring a lot of data, you may prefer to enter all of the data before dialing the host computer. You can delay the data process using the POST or post-dial function as follows.

1. Press [CLEAR] to display the idle prompt.
2. Press [BACKSPACE/POST] before beginning a transaction. This invokes the post-dial feature.
3. Press the host transaction key and proceed with your transaction as you normally would. However, the terminal will not dial the host computer until all of the data is entered.
4. When the transaction is completed, the terminal returns to the normal, pre-dial mode.

Post-dialing is only enabled for one transaction at a time. You must press [BACKSPACE/POST] before beginning each transaction that you want post-dialed.

Resetting the Calendar/Clock

The Calendar/Clock in the TRANZ 330 terminal has a built-in lithium battery to maintain the correct time even when power is removed from terminal.

To reset the clock to match your time zone or daylight saving time, follow these steps:

Display	Response
1. (idle prompt)	Simultaneously press [*] and [3].
2. PASSWORD?	If memory location 017 contains a non-zero number, you will be required to enter your password. Otherwise, skip to step 4. Enter the system password to unlock the terminal's memory. The system password supplied with each terminal is Z66831 (press: [1] [ALPHA] [ALPHA] [6] [6] [8] [3] [1]). However, if you or the application programmer have already created a new password, enter the new password.
3. *****	The terminal will display an asterisk for each key entered. After entering the complete password, press [FUNC/ENTER].
4. DIAGNOSTICS	Press [ALPHA] to begin the "reset clock" function.
5. RTC CHIP TEST	The terminal will display this message for two seconds while it tests the real time clock (RTC) chip. The terminal will then prompt you through the following entries for resetting the date and time. If you make a mistake, press [BACKSPACE] and reenter the correct information. Press [FUNC/ENTER] after each entry.

Display	Response
6. DAY OF WEEK	Enter a digit identifying the current day of the week. Valid entries are: 0 = Sunday 1 = Monday 2 = Tuesday 3 = Wednesday 4 = Thursday 5 = Friday 6 = Saturday 7 = Sunday
7. YEAR = 19	Enter the last two digits for the current year. For example, enter "87" for the year 1987.
8. MONTH =	Enter a number, 1 through 12, to identify the current month. For example, enter the number "6" for June.
9. DATE =	Enter a number, 1 through 31, to identify the current date. For example, enter "14" for the date June 14.
10. HOUR =	Enter a number, 1 through 12, to identify the current hour. For example, enter "10" if the time is 10:14.
11. AM = 0 PM = 1	Enter a "0" to indicate AM or a "1" to indicate PM.
12. MINUTES =	Enter the number of minutes, from 0 to 59, currently past the hour. For example, enter "14" if the time is 10:14.
13. SECONDS =	Enter the number of seconds from 0 to 59, currently past the minute. For example, enter "23" if the time is 10:14 and 23 seconds.
14. (day of week, date and time)	The terminal will display the new date and time.

Changing the System Password

Certain operations such as STORE and RECALL, require the use of the system password to prevent unauthorized or accidental destruction of data. Each TRANZ 330 is shipped with the factory set system password "Z66831" (press: [1] [ALPHA] [ALPHA] [6] [6] [8] [3] [1]).

You may want to change this password to an unpublished number. You can change the password at any time provided you know what the current password is. The password may contain up to nine alphanumeric characters.

Caution: If you change the system password and then forget or lose the new password, there is no method you can use to determine the new password! Losing or forgetting the new password will prevent you from adding information to memory or changing any of the information already stored in memory! However, transactions that do not require use of the password may still be executed.

The VeriFone Customer Support Department can reset the password back to Z66831. This involves shipping the terminal to the VeriFone Customer Support Center and will incur a service charge.

Follow these steps to change the system password.

Display	Response
1. (idle prompt)	Press [FUNC/ENTER].
2. FUNCTION?	Press [ALPHA].
3. ENTER OLD PASSWD	Enter the old password. <i>Note: Each keystroke is displayed as a "*" (asterisk).</i> After entering the password, press the [FUNC/ENTER] key. If the password entered does not match the current system password, the terminal will display the prompt "INVALID PASSWORD"=. Press [FUNC/ENTER] and [ALPHA] to restart the procedure and enter the correct password. If the password entered matches the current system password you will be prompted for the new password.
4. ENTER NEW PASSWD	Enter the new password. <i>Note: Each keystroke is displayed as a "*" (asterisk).</i> After entering the password, press the [FUNC/ENTER] key.

Display	Response
5. ENT PASSWD AGAIN	<p>Enter the new password again. <i>Note: Each keystroke is displayed as a "*" (asterisk).</i> After entering the password, press the [FUNC/ENTER] key.</p> <p>If you incorrectly enter the password, the terminal will abort the change password routine.</p> <p>If you correctly enter the password both times, the change is successful and the terminal returns to the idle state.</p>

Programming Error

An error condition may occur when the TRANZ 330 is in any of its five modes of operation that requires access to nonvolatile RAM and a checksum error is noted.

Error Condition Recovery

Programming error recovery allows you three options:

- to specify the last type of access to nonvolatile RAM;
- to log the programming error event;
- to manually override the operating system freeze due to nonmatching memory checksums.

Note: If the manual override is performed, memory may still be corrupted. When the override option is selected, you should reload the application as soon as possible.

There are nine codes to identify the last successful memory access operation. The code, shown below in Table 5-3, shows the type of operation running at the time of the error and when the error occurred--either at the start or end of the operation.

Table 5-3 Programming Error Type Codes

Operation Type	Begin Operation	Finish Operation
Power-up	0	
Store from TCL	1	2
Dial-up download	3	4
Store from keypad	5	6
Unit-to-unit download	7	8

**Error Condition
Display and Override**

Once the error condition has been logged, the message, "PROGRAMMING ERR X" will be displayed by the TRANZ 330, where "X" is the error code. Once this message is displayed, the terminal will remain frozen until either a re-initialization of memory or an override of the programming error is performed. Both procedures are described below:

Re-initialize Memory Procedure

Display	Response
1. PROGRAMMING ERR X	Press [1] and [ENTER] simultaneously. Wait one to two seconds.
2. DAY 1/31 12=00A (time)	RAM has been reinitialized and the terminal is ready to be reprogrammed.

Programming Error Override

Display	Response
1. PROGRAMMING ERR X	Press [5] and [3] simultaneously. Wait one to two seconds.
2. (idle prompt)	Continue with normal operations.

If the override function is activated, an entry is made into the TRANZ 330 programming error log kept in memory location 999. Up to 12 error log entries can be kept in memory location 999.

The record format is MMDDYYHHC-, where:

Value	Description
MM	month
DD	day
YY	year
HH	hour in 24 hour format
C	programming error type code
-	entry separator

6. Terminal Parameters

Your TRANZ 330 terminal must be configured with terminal-specific parameters which determine how the terminal operates. Special memory locations are reserved specifically for terminal parameters. By entering the proper parameters, you will enable the terminal to work with your on-site phone system and determine how your terminal operates with the standard application software.

For example, you can determine how many characters the terminal scrolls when the scroll key is pressed, or the phone number of the download computer.

The terminal's memory is divided into 1,000 memory locations, each having a unique three-digit address or identification number such as 000, 502 and 999. Some memory locations are dedicated to specific functions. For example, memory location 001 is reserved for the terminal's serial number and location 004 is reserved for the current date. Other memory locations are general purpose locations which can store a variety of data.

The following Table 6-1 lists the Terminal/Location parameters and their dedicated memory locations.

Table 6-1 Terminal Parameters

Memory Location	Description
000	Download Phone Number
001	Serial Number
004	Program Date
005	Message Sequence Number
006	Scroll Length
007	Multiple Transaction Timeout
009	Terminal Key Beep Flag
010	Dial Type Flag
011	Dial Speed Flag
012	Parallel Phone Available Flag
013	Number of Retries
014	Telephone Line Test Flag
017	RECALL, Set Clock, Unit-to-Unit Restriction Flag
019	Application ID
030	Idle Prompt
038	Auto Answer Control String
040-099	Memory Dial Phone Numbers (General Records)
950	Printer Type
951	Printer 250 and 600 Paper Advance (No. of Line Feeds)
958	Bell/CCITT (CCITT units only)

Memory Location	Description
960	Dial-Up Line Upload/Download Speed
965	Auto answer speed
967	Auto answer packet inactivity timeout
970	PIN Pad/Bar Code Wand Serial Port Function
975	Line REcovery Time
981	Idle Loop Control String
985	Host # for Card Initiated Transactions
986	Host # for Bar Code Initiated Transactions

Entering Terminal/ Location Parameters

If you are using a standard application or if you programmed your terminal by downloading an application from another TRANZ 330 terminal, you must configure your terminal with the Terminal/Location parameters.

Use the STORE or RECALL functions as described in Section 5 for instructions on entering information into your terminal's memory locations.

Note: If you programmed your terminal with a remote IBM PC compatible download computer, these parameters may have already been entered for you. Use the RECALL function to determine if the parameters were downloaded.

To simplify configuring your terminal, fill in the Terminal Parameters Configuration Worksheet provided at the end of this section. After completing the worksheet, you can either manually enter the data from the TRANZ 330 keypad, or you can enter it at a remote computer using the VeriFone ZON-TALK program and download it to your terminal.

Download Phone Number

Memory Location: 000
Character Type: Alphanumeric
Field Length: Up to 32 characters

This parameter is the phone number the terminal dials to connect to the remote download computer. The download phone number may contain up to 32 characters including numerals 0 through 9 and a two-second pause (-).

You can enter an access code with the phone number and, if needed, separate the two by inserting the pause character between them. For example, if you enter the common outside line access code "9" followed by a dash (-) and the phone number, the terminal will dial the 9, pause two seconds, then continue dialing the phone number. Insert additional pause characters as needed for pauses longer than two seconds.

If the memory location is empty, the terminal will automatically prompt you for the download data.

Note: Do not add a dash (-) in the middle of a phone number. This will create an unnecessary delay in dialing the number. The pause character is intended for deliberate pauses between access codes and phone numbers.

Serial Number

Memory Location: 001
Character Type: Alphanumeric
Field Length: Up to 10 characters

Turn your terminal upside down and locate the serial number on the label after the characters "S/N." Write this number down on the worksheet and enter it into memory location 001. This number identifies your terminal to the download computer.

If the memory location is empty, the terminal will automatically prompt you for the download data.

Program Date

Memory Location: 004
Character Type: Numeric
Field Length: 6 characters

Write today's date on your worksheet and enter the date into memory location 004. This records the date that the parameters in the terminal were updated.

The format for this parameter is MMDDYY. For example, to enter July 23, 1987, enter "072387."

Format	Description
MM	Month
DD	Date
YY	Year

Always update this parameter in your worksheet and terminal whenever you change any of the parameters.

Message Sequence Number

Memory Location: 005
Character Type: Numeric
Field Length: 4 characters

The TRANZ 330 terminal assigns a sequence number to every VISA second generation transaction it performs.

The terminal sequentially numbers each transaction, thus identifying the order in which the transactions are performed.

The message sequence number (also called the transaction sequence number) parameter allows you to specify the number of the first transaction in the sequence. For example, if you select the number 500, the first transaction will be numbered 500, the second 501, the third 502 and so on.

Multiple Transaction Timeout

Memory Location: 007
Character Type: Numeric
Field Length: 1 character

The multiple transactions feature of the TRANZ 330 allows the terminal to perform more than one transaction on a single call to a host computer. This parameter specifies the length of time the terminal will wait between transactions before disconnecting the phone line.

If a transaction ends and a new one doesn't begin within the time specified in this parameter, the terminal will break the phone connection with the host computer. However, as long as another transaction begins within the specified time, the terminal will remain connected.

Ten different entries are available. If nothing is entered in the memory location, the multiple transaction feature is disabled.

Entry	Timeout Length
0	Multiple transactions disabled
1	20 seconds
2	40 seconds
3	60 seconds
4	80 seconds
5	100 seconds
6	120 seconds
7	140 seconds
8	160 seconds
9	90 minutes

Scroll Length

Memory Location: 006
Character Type: Numeric
Field Length: Up to 2 characters

The TRANZ 330 terminal has a 16 character display panel which is adequate for viewing most prompts. To view messages longer than 16 characters, you will need to scroll to the right or to the left. The scroll length parameter determines the number of characters that will be scrolled each time the right [*] or left [#] scroll keys are pressed. For example, if the parameter selected is "12," pressing the [*] key will scroll the display 12 characters to the right.

Terminal Key Beep Flag

Memory Location: 009
Character Type: Numeric
Field Length: 1 character

The terminal key beep flag indicates whether or not the terminal should beep when the keys are pressed. Enter a 0 if you want a beep, or enter a 1 if you don't want a beep.

Dial Type Flag

Memory Location: 010
Character Type: Numeric
Field Length: 1 character

This parameter indicates the type of dialing your TRANZ 330 terminal will use, whether tone or pulse, and also allows enhanced pulse dialing setting for Europe.

Entry	Description
0	tone dial
1	pulse dial (USA)
2	10 - n dial
3	n + 1 dial

Note: The terminal must be configured for the type of telephone transmission used by the telephone company central office in your area. Check with your phone company if you do not know which type of service you have.

Parameters 2 and 3 contain pulse dialing settings where "n" represents the telephone number digit you dial. If you dial the digit "0" with a parameter 2 setting, there will be 10 pulses. If you dial a "1", there will be 9 pulses. Parameter 3 is just the opposite, with the digit "0" having 1 pulse and the digit "9" having 10 pulses.

Dial Speed Flag

Memory Location: 011
Character Type: Numeric
Field Length: 1 character

The TRANZ 330 terminal can be programmed to dial a phone number at one of five speeds. This parameter determines the number of digits or pulses per second. If nothing is entered for the parameter, the terminal will dial a normal 10 digits per second or 10 pulses per second.

Entry	Speed
0	5 per second; very slow dial
1	7 per second; slow dial
2	10 per second; normal dial
3	15 per second; fast dial
4	20 per second; very fast dial

Note: The Canadian Department of Communications (DOC) does not permit dialing speeds greater than 10 digits or pulses per second to be used in Canada.

Parallel Phone Available Flag

Memory Location: 012
Character Type: Numeric
Field Length: 1 character

This parameter indicates if a standard telephone is connected to the same telephone line as the TRANZ 330 terminal. This flag permits the automatic dialing of the call center of the "PICK-UP CARD" phone number provided the host computer sends a RealShare or VISA second generation type message with an autodial command.

Enter a "0" if a phone is not connected. Enter a "1" if a phone is connected.

Note: The TRANZ 330 terminal will beep when either of the automatic phone numbers is dialed, indicating that the clerk should pick up the handset for instructions.

Number of Retries

Memory Location: 013
Character Type: Numeric
Field Length: 1 character

You can select the number of times the TRANZ 330 terminal will redial a telephone number for a transaction before giving up. For example, if a "5" is entered, the terminal will dial the primary phone number up to five times followed by the secondary phone number five times. The terminal won't stop dialing until the other phone is answered or if the number of attempts indicated here are made. If no entry is made for this memory location, the terminal will default to three attempts.

Telephone Line

Memory Location: 014
Character Type: Numeric
Field Length: 1 character

This parameter tests the telephone line to determine if another telephone is being used on the same line. If the test is activated and a phone is being used, the terminal will not perform the transaction until the line is free.

The line test also enables the TRANZ 330 terminal to interact with the control signals of standard key telephone systems. In a key system, the A / A1 wires on a telephone line indicate when a call is on hold. To work on a key system, the TRANZ 330 must enable A / A1 control.

There are four options for this parameter.

Entry	Description
0	Activate A / A1, do line test.
1	Activate A / A1, don't do line test.
2	Don't activate A / A1, do line test.
3	Don't activate A / A1, don't do line test.

RECALL Set CLock Unit-to-Unit Restriction Flag

Memory Location: 017
Character Type: Numeric
Field Length: 1 character

This parameter allows you to protect memory from unauthorized or accidental alteration by putting a password restriction on the RECALL, clock setting and terminal-to-terminal download functions. If you enter a non-zero number in location 017, the system password Z66831 will be required for these functions. If you enter a zero for location 017, the password will not be required.

Application ID

Memory Location: 019
Character Type: Alphanumeric
Field Length: Up to 7 characters

The application ID identifies a custom application file name to the download computer. With this ID, the download computer can select the correct application and download it to the terminal. Obtain the application ID from the person responsible for maintaining the download computer.

If the memory location is empty, the terminal will automatically prompt you for the download data.

Idle Prompt

Memory Location: 030
Character Type: Alphanumeric
Field Length: Up to 16 characters

The standard TRANZ 330 idle prompt is the date and time. However, you can change the display by entering a new prompt in memory location 030.

You can enter any message, such as "READY" or "HELLO," with up to 16 alphanumeric characters. If memory location 030 is empty, the terminal will display the default idle prompt; the date and time.

Out of Memory Control String

Memory Location: 037
Character Type: Alphanumeric
Field Length: 120 characters

This parameter can be used by the application to automatically delete old data if the TRANZ 330 detects that all available memory is already in use.

This location is usually empty and must be custom programmed for each application to utilize this feature.

Auto Answer Control String

Memory Location: 038
Character Type: Alphanumeric
Field Length: Up to 120 characters

This parameter enables the TRANZ 330 to respond to an incoming telephone ring and communicate with another dial-up device.

This memory location is usually empty and needs to be programmed for the auto answer control string to support communication between the TRANZ 330 and the remote dial-up device.

Memory Dial Phone Numbers

Memory Location: 040-099 (general records)
Character Type: Alphanumeric
Field Length: Up to 60 characters

CAUTION: Some of these memory locations may contain application program data. Refer to your application reference manual to see which of these locations are available before entering memory dial phone numbers.

For convenient memory dialing you can store frequently called telephone numbers in the memory locations reserved for general records. To use this feature, press the [0/AUTO] key after the idle prompt and then enter the memory location that contains the phone number you want to dial.

The phone number may contain up to 60 characters including the numerals 0 through 9 and a two-second pause (-) character.

You can enter an access code with the phone number and, if needed, separate the two by inserting one pause character for each two-second pause between them. For example, if you enter the common outside line access code "9" followed by a dash (-) and the phone number, the terminal will dial the 9, pause two seconds, then continue dialing the phone number.

Note: Do not add a dash (-) in the middle of a phone number. This will create an unnecessary delay in dialing the number. The pause character is intended only for use between access codes and phone numbers.

Printer Type

Memory Location: 950
Character Type: Numeric
Field Length: 1 character

This parameter allows you to specify the type of printer you have connected to the TRANZ 330 terminal. There are currently four options.

Entry	Printer Type
0	No Printer
1	Generic roll printer
2	Printer 250 or Printer 600
3	Printer 150

Printer 250 or P600 Paper Advance

Memory Location: 951
Character Type: Numeric
Field Length: 3 characters

This parameter allows you to specify the number of line feeds a Printer 250 or Printer 600 roll printer will automatically advance after printing a receipt or transaction record. The default number of line feeds is 6. However, you can enter any number from 1-255.

Generic Printer Baud Rate

Memory Location: 952
Character Type: Numeric
Field Length: 1 character

This parameter specifies the serial port baud rate if the printer type is set for generic roll printer (950=1).

Entry	Baud Rate
0	300 baud (default)
1	600 baud
2	1200 baud
3	2400 baud
4	2400 baud
5	9600 baud
6	19200 baud

Generic Printer Data Format

Memory Location: 953
Character Type: Numeric
Field Length: 1 character

This parameter specifies the data format for the serial port if the printer type is set for a generic roll printer (950=1).

Entry	Data Format
0	7 data bits, even parity, 2 stop bits (default)
1	8 data bits, no parity, 2 stop bits

Generic Printer Handshake

Memory Location: 954
Character Type: Numeric
Field Length: 1 character

This parameter determines the type of handshaking used on the serial port if the printer type is set for generic roll printer (950=1).

Entry	Handshake
0	Hardware (CTS/RTS default)
1	None

Bell/CCITT Mode

Memory Location: 958
Character Type: Numeric
Field Length: 1 character

This parameter allows you to set the optional internal modem to either Bell or CCITT mode on CCITT units only.

Entry	Mode
<empty>	Bell
0	Bell
1	CCITT

Dial-Up Line Upload/Download Speed

Memory Location: 960
Character Type: Numeric
Field Length: 1 character

This parameter is for specifying the communications speed (baud rate) used when uploading or downloading information over a public dial-up line. The baud rate you specify must match the baud rate used by the device your TRANZ 330 is communicating with.

If the memory location is empty, the terminal will automatically prompt you for the download data.

Entry	Baud Rate
<empty>	300 Baud
1	300 Baud
2	1200 Baud (available on model 212 only)

Auto Answer Speed

Memory Location: 965
Character Type: Numeric
Field Length: 1 character

This parameter is used for specifying the communications speed (baud rate) used when the host computer calls the terminal.

Entry	Baud Rate
<empty>	300 Baud
1	300 Baud
2	1200 Baud

Auto Answer Processing

Memory Location: 966
 Character Type: Numeric
 Field Length: 1 character

This parameter allows control over how the terminal will respond when it autoanswers calls from the host computer.

Entry	Process
<empty>	Go off-hook, wait 2 seconds, execute CS in 038
2	Go off-hook, wait 2 seconds, execute CS in 038
1	Go off-hook, wait 2 seconds, raise answer carrier, execute CS in 038
0	Go off-hook, wait 2 seconds, raise answer carrier, wait for ENQ, execute CS in 038

Auto Answer Packet Inactivity Timeout

Memory Location: 967
 Character Type: Numeric
 Field Length: 1 character

This parameter determines how long the terminal will remain off hook without any communications activity from the host.

Entry	Timeout Length
0	Multiple transactions disabled
1	20 seconds
2	40 seconds
3	60 seconds
4	80 seconds
5	100 seconds
6	120 seconds
7	140 seconds
8	160 seconds
9	90 minutes

PIN Pad/ Bar Code Wand Serial Port Function

Memory Location: 970
 Character Type: Numeric
 Field Length: 1 character

If you are going to use the PIN pad/bar code wand port, you must specify its function by identifying the device is connected to it. Enter the desired number from the table below. If you are not using the port, leave this location empty or enter a "0."

Entry	Function
<empty>	Nothing Connected
0	Nothing Connected
1	Bar Code Wand
2	PIN Pad

Line Recovery Time

Memory Location: 975
Character Type: Numeric
Field Length: 1 character

When the terminal attempts to dial out and determines that the line is already in use, it will wait until the line becomes available. This parameter determines how long the terminal will remain on hook once the line is available to allow the phone company enough time to disconnect the line and prepare for the next call. Acceptable values for this parameter are in the range of 1 to 255 seconds with a default value of 3 seconds.

Free Memory Reclamation Parameter

Memory Location: 977
Character Type: Numeric
Field Length: 1 character

Version 3.X and 2.35 terminals only. This parameter controls how memory is made available for re-use once the data in it has been deleted. It is usually empty and should be custom programmed for each application to utilize the various options.

Entry	Description
0	Reclaim 1 piece of free memory after every store operation.
1	Reclaim 1 piece of free memory after each transaction or function.
2	Reclaim all free memory after each transaction or function.
3	Do not reclaim free memory.

Abort Control String

Memory Location: 979
Character Type: Alphanumeric
Field Length: 60 characters

Version 3.x terminals only. This parameter can be used to provide customized processing each time the terminal powers up, or a transaction or local function is completed. This location is usually empty and must be custom programmed for each application to utilize this feature.

Idle Loop Control String

Memory Location: 981
Character Type: Alphanumeric
Field Length: Up to 120 characters

This parameter allows you to program the TRANZ 330 to perform specific tasks while the terminal is in the idle state.

For example, the terminal can be programmed to check the current time to see if it has exceeded a predetermined trigger time then automatically dial up a remote host to upload captured records.

Host for Card Transactions

Memory Location: 985
Character Type: Numeric
Field Length: 1 character

This parameter specifies which host transaction key control string will be executed when a card is swiped through the reader from the idle state. Valid entries for this parameter are 1 through 9 with the default being 1.

Host for Bar Code Transactions

Memory Location: 986
Character Type: Numeric
Field Length: 1 character

This parameter specifies which host transaction key control string will be executed when a bar code is swiped through the reader from the idle state. Valid entries for this parameter are 1 through 9 with the default being 2.

Communication Error Control String

Memory Location: 990
Character Type: Alphanumeric
Field Length: 60 characters

By default, communication errors result in the display of an error message and the termination of the transaction in progress. This parameter is used to allow the TRANZ 330 to customize the processing of communication errors.

This location is usually empty and must be custom programmed for each application to utilize this feature.

7. Entering Transaction Parameters

Transaction Parameters

The TRANZ 330 must be configured with transaction parameters to perform transactions with a host computer. These parameters are stored in the memory locations associated with the terminal's nine transaction keys. Transaction parameters contain information that relates specifically to a host computer, such as the host telephone number or your merchant ID number. The parameters also relate to the type of transaction, whether you're performing a credit card authorization or a check authorization.

If you are using the standard application with your TRANZ 330 terminal, this section provides the background you need to enter these parameters. However, if you are using a custom application, these parameters may not apply to your terminal. Refer to your custom application manual for specific transaction information.

The TRANZ 330 accepts nine sets of transaction parameters. Each set is directly associated with one of the host transaction keys numbered 1 through 9.

By pressing one of these keys, you can initiate the desired transaction with the proper parameters for the host computer. For example, when you press [2], you initiate a transaction using parameters in memory locations 200 through 212.

Table 7-1 Transaction Parameters

Memory Location	Description	(X = transaction key on keypad)
X00	Primary Phone Number	
X01	Secondary Phone Number	
X02	Call Center Phone Number	
X03	Referral Phone Number	
X04	Merchant Identification Number	
X05	Transaction Format Flag	
X06	Fraud Control Flag	
X07	Transaction Control String	
X08	Transaction Type Prompt	
X09	Floor Limit	
X10	Response Analysis Control String	
X11	Auxiliary Control String	
X12	Multiple Transaction Group Code	
020-029	Login Strings	

TRANZ 330 Reference Manual

To simplify configuring your terminal, fill in the worksheet provided at the end of this section. After completing the worksheet, you can either manually enter the data from the TRANZ 330 keypad, or enter it at a remote computer and download it to your terminal.

Primary Phone Number

Memory location: 100, 200, 300, 400, 500, 600, 700, 800, 900
Character Type: Alphanumeric
Field Length: Up to 32 characters

This is the host computer telephone number the TRANZ 330 terminal automatically dials when you press the corresponding transaction key. Unless the application directs the terminal not to call this number, this is the first number the terminal will call. The terminal accepts up to nine primary telephone numbers, one for each host transaction key. The primary phone number may contain up to 32 characters including the numerals 0 through 9 and a two-second pause (-) character.

You can enter an access code with the phone number and, if needed, separate the two by inserting the pause character between them. For example, if you enter the common outside line access code "9" followed by a dash (-) and the phone number, the terminal will dial the 9, pause two seconds, then continue dialing the phone number.

Note: Do not add a dash (-) in the middle of a phone number. This will create an unnecessary delay in dialing the number. The pause character is intended for use between access codes and phone numbers. If the phone number is for a packet switched network such as Compuserve or Tymnet, you must add an "L" followed by the network login string number (0-9). See "Login Strings" in this section for more information.

Secondary Phone Number

Memory location: 101, 201, 301, 401, 501, 601, 701, 801, 901
Character Type: Alphanumeric
Field Length: Up to 32 characters

The secondary phone number is an alternate number for the host computer. Whenever the terminal cannot contact a host computer using the primary phone number, it will dial the secondary phone number. The format for secondary phone numbers is identical to the primary phone number format.

7. Transaction Parameters

Call Center Phone Number

Memory location: 102, 202, 302, 402, 502, 602, 702, 802, 902
Character Type: Alphanumeric
Field Length: Up to 32 characters

This is the number to dial when you cannot contact the host computer, or when you need a voice authorization code for pre-authorized transactions. Dialing this number puts you in direct contact with the call center operator. The format for the call center phone numbers is identical to the format for the primary phone numbers.

Note: The terminal will dial the call center number automatically when:

- a telephone is attached to the terminal;
- the parallel phone location is set to "1".
- the terminal is trying to process a VISA second generation or a Real-Share transaction, and;
- the terminal receives instructions from the host computer to auto dial the call center number.

Referral Phone Number

Memory location: 103, 203, 303, 403, 503, 603, 703, 803, 903
Character Type: Alphanumeric
Field Length: Up to 32 characters

When processing a transaction, the terminal may display "PICK-UP CARD" or a similar prompt. This is to warn you that the card is either stolen, fraudulent, or has some other problems. You are required to follow the card provider's policy regarding such cards.

Upon receiving such a prompt, the terminal will automatically dial the referral phone number. The person answering the call will advise you on how to proceed.

Note: The terminal will only dial the referral phone number automatically when:

- a telephone is attached to the terminal,
- the parallel phone location is set to "1".
- the terminal is trying to process a VISA second generation or RealShare transaction and;
- the terminal receives instructions from the host computer to auto dial the referral number.

The format for the referral phone number is identical to the format for the primary phone number.

TRANZ 330 Reference Manual

Merchant Identification Number

Memory location: 104, 204, 304, 404, 504, 604, 704, 804, 904
Character Type: Alphanumeric
Field Length: Up to 46 characters

This parameter (also known as the terminal ID) identifies your company and terminal to the host computer. This number is supplied by the bank or independent service provider and may contain up to 46 alphanumeric characters. A separate merchant ID is provided for each host transaction key.

Transaction Format Flag

Memory location: 105, 205, 305, 405, 505, 605, 705, 805, 905
Character Type: Numeric
Field Length: Up to 3 characters

The transaction format flag, or message format flag, tells the terminal how to format data packets for communications with the host computers. For example, a message format flag "5" can tell the terminal to send a data packet using the VISA first generation protocol, placing the transaction code before the account number, without verifying the Luhn check digit.

If nothing is entered for this parameter, the terminal will default to the standard VISA first generation format. Refer to the Appendix B in the TRANZ 330 Programming Reference Manual for specific information on the various pre-programmed protocol options.

The terminal will ignore the transaction format flag if a transaction control string memory location contains a control string (locations 107, 207, 307, 407, 507, 607, 707, 807, 907).

Sixteen different flags available, numbered from 0 to 15. The following is a description of each flag. For more information on transaction (message) format flags, refer to the TCL Programmer's Manual.

Flag	Description
0	1st generation; verifying the Luhn check-digit.
1	1st generation; without verifying the Luhn check-digit.
2	2nd generation; verifying the Luhn check-digit.
3	2nd generation; without verifying the Luhn check-digit.
4	1st generation with transaction code before account number; verifying the Luhn check-digit.
5	1st generation with transaction code before account number; without verifying the Luhn check-digit.
6	2nd generation with transaction code before account number; verifying the Luhn check-digit.
7	2nd generation with transaction code before account number; without verifying the Luhn check-digit.
8	1st generation with NDC transaction code after amount; verifying the Luhn check-digit.
9	1st generation with NDC transaction code after amount; without verifying the Luhn check-digit.

7. Transaction Parameters

Flag	Description
10	2nd generation with NDC transaction code after amount; verifying the Luhn check-digit.
11	2nd generation with NDC transaction code after amount; without verifying the Luhn check-digit.
12	1st generation with transaction code after amount; verifying the Luhn check-digit.
13	1st generation with transaction code after amount; without verifying the Luhn check-digit.
14	2nd generation with transaction code after amount; verifying the Luhn check-digit.
15	2nd generation with transaction code after amount; without verifying the Luhn check-digit.

Fraud Control Flag

Memory location: 106, 206, 306, 406, 506, 606, 706, 806, 906
Character Type: Numeric
Field Length: Up to 3 characters

The fraud control flag determines the type of fraud preventive measures that will be used in a transaction. For example, a fraud control measure may require that the operator re-enter the last four digits of a card's account number. Another measure may display the account number on the display panel so the operator can compare it with the number embossed on the card.

Although this parameter may contain up to three digits, only seven single digit options are available at this time.

Value	Description
0	No fraud control used.
1	Enter last four digits of account number.
2	Display credit card information.
3	Combine 1 and 2.
4	Blue Box Emulator enabled.
5	Blue Box Emulator enabled, override enter last four digits.
6	Blue Box Emulator enabled, display card information.
7	Blue Box Emulator enabled, display card information, override enter last four digits.

Note: To the terminal operator, options 4 and 5 are identical and options 6 and 7 are identical.

Transaction Control String

Memory location: 107, 207, 307, 407, 507, 607, 707, 807, 907
Character Type: Alphanumeric
Field Length: Up to 120 characters (see text)

The transaction control string controls the interactions between the terminal and the operator for a particular type of transaction. This includes the prompts on the display panel, the information that must be entered from the keypad, and the structure of information transmitted to the host computer.

A control string, consists of TRANZ 330 terminal control language (TCL) commands. The control string memory locations are limited to 120 characters. However, if longer control strings are required, several of them can be linked together. Refer to the TCL Programmer's Manual if you want to create your own control strings.

Note: Unless a custom control string is required, this parameter can be ignored. If this memory location is empty, one of the control strings supplied with the VeriFone standard application software will be used. The standard control strings are accessed with the Transaction Format Flag (memory locations 105, 205, 305, 405, 505, 605, 705, 805, 905).

Transaction Type Prompt

Memory location: 108, 208, 308, 408, 508, 608, 708, 808, 908
Character Type: Alphanumeric
Field Length: Up to 16 characters

The transaction type prompt displays for one second, the type of transaction selected when one of the host transaction keys is pressed. For example, the prompt may be set up to read "VISA CARD" or "CHECK." You can change these prompts to reflect the type of transaction being executed.

This parameter may include up to 16 alphanumeric characters.

Floor Limit

Memory location: 109, 209, 309, 409, 509, 609, 709, 809, 909
Character Type: Numeric
Field Length: Up to 4 characters

In the case of smaller credit card purchases, you may prefer to carry the risk of non-payment rather than incur the cost of having every transaction authorized. The floor limit is a numeric value from 0000 to 9999. This value indicates the dollar amount up to which you will accept credit without requiring a host authorization. For example, if the parameter value is 0010, the terminal will display "BELOW LIMIT" and abort the transaction for sales of \$10.00 or less.

7. Transaction Parameters

Response Analysis Control String

Memory location: 110, 210, 310, 410, 510, 610, 710, 810, 910
Character Type: Alphanumeric
Field Length: Up to 120 characters (see text)

This parameter is a control string used in custom applications to analyze and act on a message received from the host computer. Like other TRANZ 330 control strings, the control string memory locations are limited to 120 characters. However, if longer control strings are required, several of them can be linked together. Refer to the TCL Programmer's Manual for more information on Response Analysis Control Strings.

Auxiliary Control String

Memory location: 111, 211, 311, 411, 511, 611, 711, 811, 911
Character Type: Alphanumeric
Field Length: Up to 120 characters (see text)

The auxiliary control string, used in custom applications, can be used for a variety of tasks such as formatting and controlling the output to the printer.

This parameter is a control string used in custom applications to analyze and act on a message received from the host computer. Like other TRANZ 330 control strings, the control string memory locations are limited to 120 characters. However, if longer control strings are required, several of them can be linked together. Refer to the TCL Programmer's Manual for more information on Auxiliary Control Strings.

Multiple Transaction Group Code

Memory location: 112, 212, 312, 412, 512, 612, 712, 812, 912
Character Type: Numeric
Field Length: 1 character

A multiple transaction group consists of different transactions that share the same host computer. By assigning a common group code to each of these transactions, you can perform a number of transactions with the same host on one phone call.

For example, when you initiate a multiple transaction operation, the terminal automatically dials the host computer for the first transaction. When the first transaction is finished, the terminal will wait for you to initiate another transaction that shares the same group number and host computer. The terminal will remain connected to the host computer after each transaction, unless no more transactions are initiated within a specific length of time (see multiple transaction timeout in Section 6).

This code is a one digit number from 1 to 9, representing the multiple transaction group. Assign the same group code number to transactions requiring communication with the same host computer.

Login Strings

Memory location: 020, 021, 022, 023, 024, 025, 026, 027, 028, 029,
Character Type: Alphanumeric
Field Length: Up to 60 characters

A login string consists of a network code, a user name, and a password. Login strings are used only when the host computer is accessed through a private network. You do not need a login string if you dial the host computer directly.

The TRANZ 330 terminal can store up to 10 different login strings and can dial eight different networks.

Login strings are activated when the terminal dials a phone number that ends with the letter "L" followed by a numeral (0-9) that corresponds to the last digit of the login string memory location. For example, "L4" at the end of a phone number specifies login string 024 and "L7" specifies login string 027.

The first component of the login string is a single digit network code. The different network codes currently available are as follows:

Code	Network
1	Tymnet
2	Compuserve
3	Telenet
4	Geisco
5	Nabanco/Western Union
6	Busycmm
7	Datapac (Canada)--no parity
8	Autonet
9	Connet
A	Datapac--even parity
B	Western Union

The second component is your network username and the third is your password to the network. The three components of the login string must be separated by dashes (Code-Username-Password).

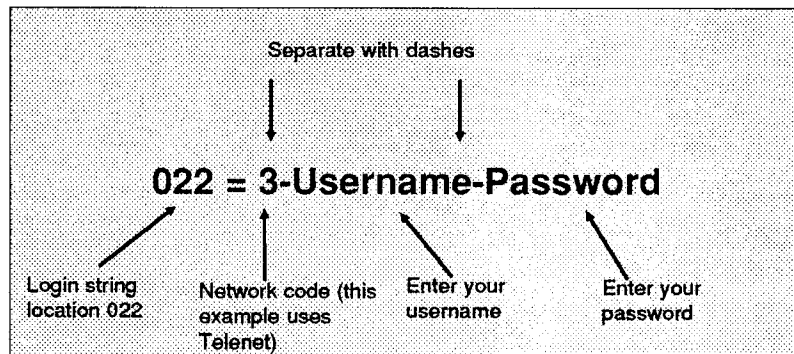

Figure 7-8 Network Login Strings

Refer to the information supplied by your network for additional information regarding your username and password.

Soft Login

Eprom versions 3.30 and greater feature a "soft" login that can be programmed at the application level. In earlier versions, the "Ln" following the phone number selects a login contained in the eprom, where "n" represents a number from 0 - 9 (referencing memory locations 020 - 029). When the terminal encounters "Ln", the operating system executes the data at that location.

If your terminal contains version 3.30 or greater and you wish to select a new login, use "Xn" following the phone number for the operating system to execute the login control string referenced in memory location "n".

Note: This memory location should be dedicated to perform a login and should return to allow normal transaction flows to occur once the login is completed.

Format in memory locations 020 - 029 remain the same except that the first parameter represents the login control string to execute rather than a login selection. Remaining parameters (user name, user password, user location and location password) separated by a hyphen, do not change.

Refer to the new +P, +X and +Y commands in the TCL Programmer's Manual, part number 00368, revision F, for information on setting soft login protocol parameters.

8. Maintenance and Diagnostics

VeriFone follows stringent quality control standards when manufacturing the TRANZ 330 and all of its other products. Each unit that leaves the factory receives numerous tests to ensure quality and reliable operation. However, should you encounter a problem in operation, read this section for possible causes and solutions.

Cleaning

Periodically clean your TRANZ 330 terminal using a cloth dampened with water and a mild soap or cleaner. Do not use harsh chemicals.

Warning: Because your terminal can be damaged by liquids, do not spray liquid cleaners directly on the terminal. Always apply the cleaner to the cloth before cleaning the TRANZ 330.

Returning the TRANZ 330 Terminal for Service

For replacement or repair of your TRANZ 330 terminal, call the toll free number given below. Be sure to mention the serial number found on the bottom of your TRANZ 330 terminal.

If you are located in the United States, call: 800-654-1674.

If you are located outside the United States, call 714-979-1870.

Unless otherwise instructed in this reference manual, do not, under any circumstances, attempt any service, adjustments or repairs on this unit.

If your equipment failure cannot be resolved, call the toll free (800-654-1674) VeriFone Customer Support Hot Line and ask for an MRA (Merchandise Return Authorization) approval number. You must have an MRA approval number before returning your equipment for repair.

Troubleshooting

These troubleshooting guidelines identify various problems and the appropriate corrective action. If you have problems operating your TRANZ 330 terminal, read these troubleshooting examples. If your problem persists, or if it is not listed here, call the VeriFone Customer Support Hot Line listed above.

Error Messages

Appendix C in this manual lists the different prompts and error messages that may appear on the display panel. If you see any of these messages, refer to Appendix C or to your application manual for an explanation of the message.

Display Panel does not Display Correct Information

If the TRANZ 330 displays incorrect information, such as an unreadable message or nothing at all, you may have a power supply problem or a defective terminal. Follow these steps to determine the cause of the problem.

1. Check all of your cable connections and verify that your telephone line is connected properly.
2. Check your AC outlet to be sure it is supplying sufficient power.
3. Run the Display Test, as described later in this section, to ensure the display components are working.
4. Substitute your power pack with another TRANZ 330 power pack. If this solves the problem, call the toll free VeriFone Customer Support Hot Line to obtain a replacement power pack.
5. Your application may not be properly loaded. Download your application and try again.
6. If the problem persists, call the toll free VeriFone Customer Support Hot Line to have your terminal repaired or replaced.

Telephone does not Work Properly

1. Check your telephone line and telephone connections.
2. Check the phone lines using another standard telephone. If the other telephone works, have your telephone repaired or replaced.
3. If using another TRANZ 330 or telephone does not work, have your phone line serviced.

Printer does not Work

1. Check that you are using the proper cable and that all the cable connections for the printer are connected to the TRANZ 330.
2. Check the AC outlet for the printer to be sure it is supplying sufficient power.
3. Use the RECALL function to ensure that memory location 950 contains the correct data for your printer type ("1" for a generic roll printer; "2" for the Printer 250 or Printer 600; "3" for a Printer 150). See Printer Type in Section 6.
4. Refer to the instructions supplied with the printer for further information.

Bar Code Wand does not Work

1. Check all your cable connections.
2. Draw the wand across a different bar code to ensure the problem is not an unreadable bar code on the label.
3. Use the RECALL function to verify that memory location 970 contains the number "1" indicating bar code wand operation.
4. Run the Bar Code test as described later in this section.

PIN Pad does not Work

1. Check all of your cable connections.
2. Try a different credit card to ensure the problem is not a defective card.
3. Use the RECALL function to verify that memory location 970 contains the number "2" indicating PIN Pad operation.
4. Call the toll free VeriFone Customer Support Hot Line for further instructions.

Terminal Transactions do not Work

1. Perform your transactions using several credit cards to ensure the problem is not a defective card. When sliding the cards through the card reader, be sure the magnetic stripe faces down and to the right of the terminal.
2. Your application may not be properly loaded. Download your application and try again.
3. Perform a manual transaction using the keypad instead of the card reader. If the transaction works, call the toll free VeriFone Customer Support Hot Line to have your terminal repaired or replaced.
4. If the manual transaction does not work, check your telephone line using another TRANZ 330 or a standard telephone.
5. If the telephone line does not work, check with the party you are trying to call to see if their system is operational and have your line checked by your telephone company.
6. If the telephone line works, call the VeriFone Customer Support Hot Line to return your terminal for service.

Keypad does not Respond

1. Check your display panel. If it displays the wrong characters or nothing at all, refer to the first item in this troubleshooting section, "Display Panel does not Display Correct Information".
2. Press several keys. If memory location 009 contains a "0," you should hear a short beep each time you press a key. If key beep works, check your application manual to be sure you are entering the correct data.
4. Run the Keypad Test as described later in this section to ensure the keypad components are working properly.
5. Your application may not be properly loaded. Download your application and try again.
6. If memory location 009 contains a "0" or is <empty> and you do not hear any beep, or if the keys do not operate as the application says they should, contact the MRA desk.

TRANZ 330 Diagnostics

The TRANZ 330 has a built-in diagnostic mode to help you perform various tests and operations using the TRANZ 330 keypad. The following instructions describe how to enter the diagnostic mode and perform the different routines available.

Display	Response																
1. (idle prompt)	Simultaneously press the [*] and [3] keys.																
2. DIAGNOSTICS	Press the key that corresponds to the function you want. The functions available are:																
	<table border="0" style="width: 100%;"> <thead> <tr> <th style="text-align: left;">Key</th> <th style="text-align: left;">Function</th> </tr> </thead> <tbody> <tr> <td>[1]</td> <td>Memory Test</td> </tr> <tr> <td>[2]</td> <td>Keypad Test</td> </tr> <tr> <td>[3]</td> <td>Display Test</td> </tr> <tr> <td>[4]</td> <td>Card Reader Test</td> </tr> <tr> <td>[ALPHA]</td> <td>Set Clock</td> </tr> <tr> <td>[BACKSPACE]</td> <td>Bar Code Test</td> </tr> <tr> <td>[CLEAR]</td> <td>Return to Idle Prompt</td> </tr> </tbody> </table>	Key	Function	[1]	Memory Test	[2]	Keypad Test	[3]	Display Test	[4]	Card Reader Test	[ALPHA]	Set Clock	[BACKSPACE]	Bar Code Test	[CLEAR]	Return to Idle Prompt
Key	Function																
[1]	Memory Test																
[2]	Keypad Test																
[3]	Display Test																
[4]	Card Reader Test																
[ALPHA]	Set Clock																
[BACKSPACE]	Bar Code Test																
[CLEAR]	Return to Idle Prompt																

TRANZ 330 Memory Test

This test checks the TRANZ 330's RAM memory.

Display	Response
1. (idle prompt)	Simultaneously press the [*] and [3] keys.
2. DIAGNOSTICS	Press the [1] key for the Memory Test function.
3. MEMORY TEST	The TRANZ 330 will run the memory test on RAM. Press and hold down [CLEAR] to return to the idle prompt.

TRANZ 330 Keypad Test

The keypad test determines if the TRANZ 330 keys are functioning properly.

Display	Response
1. (idle prompt)	Simultaneously press the [*] and [3] keys.
2. DIAGNOSTICS	Press the [2] key for the Keypad Test.
	Press any key. The number or character will appear in every character segment of the display panel.
	Pressing the [BACKSPACE], [ALPHA], or [FUNC/ENTER] keys will display the characters B, C, and D respectively.
	If none of the keys respond, the problem may be with your display panel or power pack. Perform the Display Test and check the power pack before calling the Customer Support Hot Line.

8. Maintenance and Diagnostics

Display

Response

If one or only several keys do not respond, call the VeriFone Customer Support Hot Line to have your unit repaired or replaced.

- To return to the idle prompt, press the [CLEAR] key.

TRANZ 330 Display Test

The Display Test consists of three different display patterns that verify the lights in the display panel are working.

Display

Response

1. (idle prompt)
2. DIAGNOSTICS
3. (display patterns)

Simultaneously press the [*] and [3] keys.

Press the [3] key for the Display Test function.

These three displays will appear, one after another, on the display panel.

```
*****  
,,  
0000000000000000  
*0,
```

Check the different test patterns to be sure all of the segments are lighting properly.

Be sure that the third test only displays three characters. If more characters are displayed, the display is "ghosting."

If some of the segments are not lit, or if the displays do not match what you see in this manual, call the VeriFone Customer Support Hot Line to have your unit repaired or replaced.

4. DIAGNOSTICS

When the Display Test is complete, the terminal will return to the diagnostic mode. Press [CLEAR] to return to the idle prompt.

TRANZ 330 Display Messages Test

This test displays all status and error messages and fixed prompts contained in the terminal.

Display

Response

1. (idle prompt)
2. DIAGNOSTICS
3. TZ330 3E2AU210
READY...

Press [*] and [3] simultaneously

Press [0].

Press [ENTER] to scroll forward.

Press [CLEAR] to end routine.

TRANZ 330 Card Reader Test

This test checks the operation of the Card Reader.

Display	Response
1. (idle prompt)	Simultaneously press the [*] and [3] keys.
2. DIAGNOSTICS	Press the [4] key for the Card Reader Test function.
3. WIPE CARD NOW	Place a credit card in the back of the slot with the magnetic stripe down and towards the right of the TRANZ 330 terminal. Briskly slide the card towards you without stopping.
4. (account number)	<p>The account number on the card will appear in the display panel if the test is successful.</p> <p>If the test is not successful, you will receive an error message. If you receive an error message, repeat the procedure with another card.</p> <p>If the problem persists, call the VeriFone Customer Service Hot Line.</p>

Resetting the TRANZ 330 Calendar/ Clock

This operation is described in Section 5 under the heading Resetting the Calendar/Clock.

TRANZ 330 Bar Code Wand Test

The test checks the operation of the Bar Code Wand.

Display	Response
1. (idle prompt)	Simultaneously press the [*] and [3] keys.
2. DIAGNOSTICS	Press the [BACKSPACE] key for the Bar Code Wand Test function.
3. BAR CODE TEST	Draw the bar code wand across a bar code.
4. (bar code information)	<p>If the test is successful, the display panel will show the encoded bar code information.</p> <p>If the test is not successful, you will receive an error message. If this occurs, repeat the procedure with another bar code.</p> <p>If the problem persists, call the VeriFone Customer Service Hot Line to have your unit repaired or replaced.</p> <p>Press the [CLEAR] key to return to the idle prompt.</p>

TRANZ 330 Transaction Simulation

The following two tests allow you to run demonstration transactions from the cardreader and keypad.

Cardreader Entry

Display	Response
1. (idle prompt)	Simultaneously press the [*] and [3] keys.
2. DIAGNOSTICS	Press [9].
3. ENTER ACCOUNT #	Swipe the card through the reader with its magnetic stripe facing the keyboard.
4. AMOUNT OF SALE?	Enter in the amount of sale on the keypad.
5. DIALING TRANSMITTING RECEIVING DEMO APPROVAL XXXXXX	Dialing to approval takes 25 seconds. The approval is a randomly-selected number and will remain displayed for 15 seconds. The display then returns to the idle prompt.

Keypad Entry

Display	Response
1. (idle prompt)	Simultaneously press the [*] and [3] keys.
2. DIAGNOSTICS	Press [9].
3. ENTER ACCOUNT #	Enter the account number on the keypad.
4. ENTER DATE	Enter the expiration date of the card. The number should not exceed four digits.
5. AMOUNT OF SALE?	Enter the amount of sale on the keypad.
6. DIALING TRANSMITTING RECEIVING DEMO APPROVAL XXXXXX	Dialing to approval takes 25 seconds. The approval is a randomly-selected number and will remain displayed for 15 seconds. The display then returns to the idle prompt.

Appendix A.

Memory Locations

Functional Listing of Memory Locations

The following is a functional listing of the TRANZ 330 terminal memory locations. A numeric listing of these memory locations follows.

Terminal Parameters

Memory Location	Description
000	Download Phone Number
001	Serial Number
004	Program Date
005	Transaction Sequence Number
006	Scroll Length Flag
007	Multiple Transaction Timeout
008	Reserved
009	Terminal Key Beep
010	Dial Type Flag
011	Dial Speed Flag
012	Parallel Phone Available Flag
013	Number of Attempts
014	Telephone Line Test
950	Printer Type Flag
951	Number of Line Feeds for Printer 200
958	Bell/CCITT (CCITT units only)
960	Dial-up Line Upload/Download Speed
965	Auto Answer Speed
966	Auto Answer Processing
967	Auto Answer Packet Inactivity Timeout
970	Pin Pad/Bar Code Wand Port Function
975	Line recovery Time
985	Host # for Card Initiated Transactions
986	Host # for Bar Code Initiated Transactions

Buffers

Memory Location	Description
002	Transmit Buffer
003	Receive Buffer
018	Error Statistics Buffer

TRANZ 330 Reference Manual

Miscellaneous	Memory Location	Description
	019	Application ID
	030	Idle Prompt
	037	Out of Memory Control String
	990	Communication Error Control String

Login Strings and Function Key Control Strings	Memory Location	Description
	020	Login String #0
	021	Login String #1
	022	Login String #2
	023	Login String #3
	024	Login String #4
	025	Login String #5
	026	Login String #6
	027	Login String #7
	028	Login String #8
	029	Login String #9
	031	Function Key #1
	032	Function Key #2
	033	Function Key #3
	034	Function Key #4
	035	Function Key #5
	036	Function Key #6
	039	Function Key #9

General Records	Memory Location
	040-099
	113-199
	213-299
	313-399
	413-499
	513-599
	613-699
	713-799
	813-899
	913-949

Idle Loop	Memory Location	Description
	981	Idle Loop Control String
	982	Idle Loop Phone Number
	983	Idle Loop Response Analysis Control String
	984	Idle Loop Inactivity Timeout

Auto Answer

Memory Location	Description
038	Auto Answer Control String
965	Auto Answer Speed
966	Auto Answer Processing
967	Auto Answer Packet Inactivity Timeout

Printer Information

Memory Location	Description
950	Printer Type Flag
951	Number of Roll Printer Line Feeds
952	Baud for Generic Roll Printer
953	Data Format for Generic Roll Printer
954	Handshake for Generic Roll Printer

Host Parameters

Parameter Transaction Key	Memory Location								
	#1	#2	#3	#4	#5	#6	#7	#8	#9
Primary Phone Number	100	200	300	400	500	600	700	800	900
Secondary Phone Number	101	201	301	401	501	601	701	801	901
Call Center Phone Number	102	202	302	402	502	602	702	802	902
Referral Phone Number	103	203	303	403	503	603	703	803	903
Merchant/Terminal ID	104	204	304	404	504	604	704	804	904
Message Format Flag	105	205	305	405	505	605	705	805	905
Fraud Control Flag	106	206	306	406	506	606	706	806	906
Transaction Control String	107	207	307	407	507	607	707	807	907
Transaction Type Prompt	108	208	308	408	508	608	708	808	908
Floor Limit	109	209	309	409	509	609	709	809	909
Respse Analysis Control String	110	210	310	410	510	610	710	810	910
Auxiliary Control String	111	211	311	411	511	611	711	811	911
Multiple Trans Group Code	112	212	312	412	512	612	712	812	912

Numeric Listing of Memory Locations

In addition to the memory location number and description, this numeric listing also includes the character type and the field lengths for the TRANZ 330 memory locations.

The character type indicates which characters are permitted in these memory locations. "X" represents alphanumeric characters which include the letters A through Z, the numerals 0 through 9, and special characters * , ' " - # and (space). "9" represents the numeric characters 0 through 9.

The field length indicates the maximum number of characters that can be stored in the memory location.

Sections 6 and 7 provide detailed information on the memory locations used with the TRANZ 330 standard application.

TRANZ 330 Reference Manual

Memory Location	Character Type	Field Length	Description
000	X	20	Download Phone Number
001	X	10	Serial Number
002	--	--	Transmit Buffer
003	--	--	Receive Buffer
004	9	6	Program Date
005	9	4	Message Sequence Number
006	9	2	Number of Characters to Scroll
007	9	1	Multiple Transaction Timeout
008	9	5	Reserved
009	9	1	Beeper On/Off
010	9	1	Dial Type Flag (Tone/Pulse)
011	9	1	Dial Speed Flag
012	9	1	Parallel Phone Available Flag
013	9	1	Number of Retries
014	9	1	Line Test
015	9	3	Delay Before Auto Answer
016	X	120	General Record
017	9	1	RECALL, Clock, Unit/Unit Restriction
018	9	16	Error Statistics
019	X	7	Application Identification
020	X	60	Login String #0
021	X	60	Login String #1
022	X	60	Login String #2
023	X	60	Login String #3
024	X	60	Login String #4
025	X	60	Login String #5
026	X	60	Login String #6
027	X	60	Login String #7
028	X	60	Login String #8
029	X	60	Login String #9
030	X	16	Idle Prompt
031	X	120	Function Key #1 Control String
032	X	120	Function Key #2 Control String
033	X	120	Function Key #3 Control String
034	X	120	Function Key #4 Control String
035	X	120	Function Key #5 Control String
036	X	120	Function Key #6 Control String
037	X	120	Out of Memory Control String
038	X	120	Auto Answer Control String
039	X	120	Function Key #9 Control String
040 to 099	X	120	General Records 40 to 99

*X = alphanumeric; 9 = numeric

Appendix A. Memory Locations

Memory Location	Character Type	Field Length	Description
100	X	32	Primary Phone Number
101	X	32	Secondary Phone Number
102	X	32	Call Center Phone Number
103	X	32	Referral Phone Number
104	X	46	Merchant/Terminal ID
105	9	3	Message Format Flag
106	9	3	Fraud Control Flag
107	X	120	Transaction Control String
108	X	16	Transaction Type Prompt
109	9	4	Floor Limit
110	X	120	Response Analysis Control String
111	X	120	Auxiliary Control String
112	9	1	Multi-Transaction Group Code
113 to 199	X	120	General Locations 113 to 199
200	X	32	Primary Phone Number
201	X	32	Secondary Phone Number
202	X	32	Call Center Phone Number
203	X	32	Referral Phone Number
204	X	46	Merchant/Terminal ID
205	9	3	Message Format Flag
206	9	3	Fraud Control Flag
207	X	120	Transaction Control String
208	X	16	Transaction Type Prompt
209	9	4	Floor Limit
210	X	120	Response Analysis Control String
211	X	120	Auxiliary Control String
212	9	1	Multi-Transaction Group Code
213 to 299	X	120	General Locations 213 to 299
300	X	32	Primary Phone Number
301	X	32	Secondary Phone Number
302	X	32	Call Center Phone Number
303	X	32	Referral Phone number
304	X	46	Merchant/Terminal ID
305	9	3	Message Format Flag
306	9	3	Fraud Control Flag
307	X	120	Transaction Control String
308	X	16	Transaction Type Prompt
309	9	4	Floor Limit
310	X	120	Response Analysis Control String
311	X	120	Auxiliary Control String
312	9	1	Multi-Transaction Group Code
313 to 399	X	120	General Locations 319 to 399

*X = alphanumeric; 9 = numeric

TRANZ 330 Reference Manual

Memory Location	Character Type*	Field Length	Description
400	X	32	Primary Phone Number
401	X	32	Secondary Phone Number
402	X	32	Call Center Phone Number
403	X	32	Referral Phone Number
404	X	46	Merchant/Terminal ID
405	9	3	Message Format Flag
406	9	3	Fraud Control Flag
407	X	120	Transaction Control String
408	X	16	Transaction Type Prompt
409	9	4	Floor Limit
410	X	120	Response Analysis Control String
411	X	120	Auxiliary Control String
412	9	1	Multi-Transaction Group Code
413 to 499	X	120	General Locations 413 to 499
500	X	32	Primary Phone Number
501	X	32	Secondary Phone Number
502	X	32	Call Center Phone Number
503	X	32	Referral Phone Number
504	X	46	Merchant/Terminal ID
505	9	3	Message Format Flag
506	9	3	Fraud Control Flag
507	X	120	Transaction Control String
508	X	16	Transaction Type Prompt
509	9	4	Floor Limit
510	X	120	Response Analysis Control String
511	X	120	Auxiliary Control String
512	9	1	Multi-Transaction Group Code
513 to 599	X	120	General Locations 513 to 599
600	X	32	Primary Phone Number
601	X	32	Secondary Phone Number
602	X	32	Call Center Phone Number
603	X	32	Referral Phone Number
604	X	46	Merchant/Terminal ID
605	9	3	Message Format Flag
606	9	3	Fraud Control Flag
607	X	120	Transaction Control String
608	X	16	Transaction Type Prompt
609	9	4	Floor Limit
610	X	120	Response Analysis Control String
611	X	120	Auxiliary Control String
612	9	1	Multi-Transaction Group Code
613 to 699	X	120	General Locations 613 to 699

*X = alphanumeric; 9 = numeric

Appendix A. Memory Locations

Memory Location	Character Type	Field Length	Description
700	X	32	Primary Phone Number
701	X	32	Secondary Phone Number
702	X	32	Call Center Phone Number
703	X	32	Referral Phone Number
704	X	46	Merchant/Terminal ID
705	9	3	Message Format Flag
706	9	3	Fraud Control Flag
707	X	120	Transaction Control String
708	X	16	Transaction Type Prompt
709	9	4	Floor Limit
710	X	120	Response Analysis Control String
711	X	120	Auxiliary Control String
712	9	1	Multi-Transaction Group Code
713 to 799	X	120	General Locations 713 to 799
800	X	32	Primary Phone Number
801	X	32	Secondary Phone Number
802	X	32	Call Center Phone Number
803	X	32	Referral Phone Number
804	X	46	Merchant/Terminal ID
805	9	3	Message Format Flag
806	9	3	Fraud Control Flag
807	X	120	Transaction Control String
808	X	16	Transaction Type Prompt
809	9	4	Floor Limit
810	X	120	Response Analysis Control String
811	X	120	Auxiliary Control String
812	9	1	Multi-Transaction Group Code
813 to 899	X	120	General Locations 813 to 899
900	X	32	Primary Phone Number
901	X	32	Secondary Phone Number
902	X	32	Call Center Phone Number
903	X	32	Referral Phone Number
904	X	46	Merchant/Terminal ID
905	9	3	Message Format Flag
906	9	3	Fraud Control Flag
907	X	120	Transaction Control String
908	X	16	Transaction Type Prompt
909	9	4	Floor Limit

*X = alphanumeric; 9 = numeric

TRANZ 330 Reference Manual

Memory Location	Character Type	Field Length	Description
910	X	120	Response Analysis Control String
911	X	120	Auxiliary Control String
912	9	1	Multi-Transaction Group Code
913 to 949	X	120	General Locations 913 to 949
950	X	60	Printer Type Flag
951	X	60	No. Line Feeds for Printer 250 or P600
952	X	60	Baud For Generic Roll Printer
953	X	60	Data Format For Generic Roll Printer
954	X	60	Handshake For Generic Roll Printer
955 to 957	X	60	Reserved
958	X	60	Bell/CCITT (CCITT units only)
959	X	60	Reserved
960	X	60	Dial-up Line Upload/Download Speed
961 to 964	X	60	Reserved
965	X	60	Auto Answer Speed
966	9	1	Auto Answer Processing
967	9	1	Auto Answer Packet Inactivity Timeout
968 to 969	X	60	Reserved
970	X	60	DIN 6 Peripheral
971 to 974	X	60	Reserved
975	X	60	Line Recovery Time
976	X	60	Reserved
977	9	1	Free Memory Relaimation Parameter
978	X	60	Reserved
979	X	60	Abort Control String
980	X	120	Delay Executing Idle Loop Control String
981	X	120	Idle Loop Control String
982	X	60	Idle Loop Phone Number
983	X	120	Idle Loop Response Analysis Control String
984	X	60	Idle Loop Inactivity Timeout
985	9	1	Host Number For Card Initiated Trans
986	9	1	Host Number For Bar Code Initiated Trans
987 to 989	X	60	Reserved
990	X	120	Communication Error Control String
991 to 996	X	60	Reserved
997	X	120	VeriFone Control String
998	X	60	Reserved
999	X	60	Programming Error Recovery Log

*X = alphanumeric; 9 = numeric

Appendix B.

Features and Specifications

- Microprocessor** • Z-80 CPU operating at 4 MHz.
- Memory** • 32K bytes EPROM standard
• 32K RAM
- Cardreader** • Standard American Bankers Association (ABA) track 2 magnetic cardreader--accepts all major credit cards.
• Optional ABA Track 1 cardreader.
- Display** • 16-character fluorescent alphanumeric with decimal point and comma.
- Miscellaneous** • Built-in calendar/clock chip for maintaining accurate date and time. Can be used with Printer 150 or 250 for date and time stamping of transactions, reports and receipts.
• Internal lithium battery backup power source for RAM in the event of a power failure.
• Display panel and keypad accepts alphanumeric characters including letters A through Z, numerals 0 through 9, and special characters * , ' " - . # : ; @ (space).
- Communication** • Automatic dialing in any of five speeds
• Auto-answer
• Bi-directional local communications via RS-232 port.
• Multiple terminals can share the same telephone line.
• Terminal dials either touch tone or pulse (rotary mode) and accepts 32-digit telephone numbers.
• Automatically dials host telephone and call center numbers.
- Modem** • Internal modem with modular jack.
- Model 202** • Standard TRANZ 330 (202) leased line configuration.
• 1200 baud (Bell 202 type) modem.
- Model 212** • Standard Bell 212A high-speed dial-up modem 1200 and 300 baud.
- Model CCITT V.21/V.22** • Optional internal 300/1200 baud modem for international telephone systems.

TRANZ 330 Reference Manual

- Restricted Memory Accessibility**
 - Memory can be locked by application and/or password protected to prevent accidental erasure and unauthorized tampering and reading of data.
- Multiple Transaction Capability**
 - TRANZ 330 terminal can process multiple transactions to the same host computer on a single dial-up. User selectable timeout to limit idle time between transactions.
- Custom Security and Fraud Control**
 - Built-in security and fraud controls including account number verification using Luhn check digit, displaying the magnetic stripe information for verification, and MasterCard "Blue Box" emulation for even more fraud control.
- User Programmable Password**
 - User programmable password locks memory to prevent unauthorized use of terminal.
- Selection of Transaction Data Formats**
 - TRANZ 330 includes 16 built-in transaction data formats to assist the programmer. These are industry standard formats with standard display prompts to handle many common transactions.
 - Options
 - Bar Code Wand (Code 39)
 - Encrypting PIN Pad
 - ZONTALK software for downloading application programs and maintaining terminal inventory.
 - Standard telephone
 - Slip printer
 - Roll printer
 - Custom keypad overlays
- Power Requirements**
 - Voltage: 120 volts AC, 60Hz
 - Power: 10W
- Environmental**
 - Operating Temperature: 0-40° C. 32-104° F.
 - Humidity: 0 to 90% relative humidity; no condensation.
- Dimensions and Weight**
 - Height: 1.5 in (38.10 mm)
 - Width: 5.6 in (143.10 mm)
 - Depth: 6.0 in (152.40 mm)
 - Shipping Weight: 2.2 lbs (1.0 kg)

Appendix B: Features and Specifications

RS232 Serial Port 8-Pin DIN connector

Pin	Function
1	GND - Signal Ground
2	DCD - Data Carrier Detect
3	RTS- Request To Send
4	CTS - Clear To Send
5	RXD - Receive Data
6	TXD - Transmit Data
7 & 8	No connection

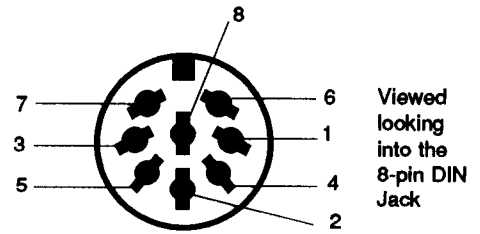

NOTE: This port driver does not support XON/XOFF protocol or more than 1.5 stop bits.

PIN Pad/Bar Code Serial Port 6-Pin DIN connector

Pin	Function
1	+5 volts (through 4.7 ohm resistor)
2	Bar code receive data
3	PIN Pad receive data (input port)
4	PIN Pad transmit data (output port)
5	GND (through 47 ohm resistor)
6	+9 v unregulated PIN Pad power

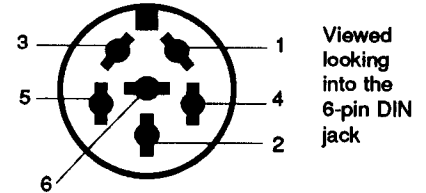

Serial Telephone Line (modem) Interface

PIN	Signal
1	(not used)
2	A
3	ring
4	Tip
5	A1
6	(not used)

DAILUP

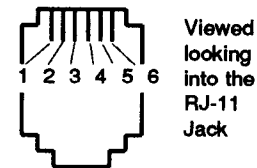

- Uses a USOC RJ11 modular telephone jack to connect to ordinary dial-up telephone line. Four conductor telephone line cord with modular plugs furnished with terminal.
- Default modem data format: 7 data bits, even parity, 1 stop bit. Serial Interface

TRANZ 330 Reference Manual

Accessories	Part Number	Description
Direct Download Cable	00446-05	TRANZ 330 to IBM PC or compatible personal computer
	00446-04	TRANZ 330 IBM AT or compatible personal computer
	00490-00	TRANZ 330 to TRANZ 330
Printers	P002-114-XX	Printer 150 Slip Printer (Grey)
	10465-XX	Cable, TRANZ 330 to Printer 150 (standard mode)
	10392-XX	Cable, TRANZ 330 to Printer 150 (P100 emulation mode)
	10580-01	Stacker 5 (for use with Printer 150)
	P002-113-00	Printer 250 Roll Printer
	10448-XX	Cable, TRANZ 330 to Printer 250 (straight terminal connector)
	10454-XX	Cable, TRANZ 330 to Printer 250 (90-degree terminal connector)
	10580-01	Stacker 5 (for use with Printer 250)
	P002-116-00	Printer 500 Slip/Roll Printer
	10488-XX	Cable, TRANZ 330 to Printer 500 (straight terminal connector)
	10454-XX	Cable, TRANZ 330 to Printer 500 (90-degree terminal connector)
	10978-00	Cash Drawer Cable Adapter
	P002-117-00	Printer 600 Roll Printer
	10448-XX	Cable, TRANZ 330, ZON Jr XL, ZON II XJ, ZON II XPe, TRANZIT XPe, TRANZIT 1200C, ZON 530/531 to Printer 600
10454-XX*	Cable, ZON Jr XL, TRANZIT 1200C, ZON 540/541 to Printer 600 (90-degree connector)	
10512	Cable, ZON, ZON II to Printer 600	
*Not for use with metal case terminals ZON 530M, ZON 531M, ZON 540M and ZON 541M. Use cable P/N 10448-XX.		
Peripheral Devices	00302-03	BarCode Wand
	P003-104-01	PIN Pad 201 (Potted 1E Grey)
	01582-00	Cable, TRANZ 330 to PIN Pad 201
Programming Languages	P006-105-00	TCL Programming (TCLOAD manual and diskette)
Reference Manual	00368	TCL Terminal control Language Programming Manual
Consumables	You can now order consumables such as paper and ribbons by telephone or FAX. To order by phone, call 800-233-0522. To order by FAX, dial 714-434-2498.	

- n the login string specifier. Valid entries are numbers 0 through 9.
- BAD LRC** The terminal displays this message during a cardreader test, when the card's Longitudinal Redundancy Character (LRC) does not match the LRC computed by the terminal.
The cardreader may have had a problem reading the card. Slide the card through the cardreader again. You may try sliding the card faster or slower. If the problem persists, call your customer help desk.
- BAD RAM** The terminal has detected a bad RAM chip.
Power-down the terminal, then power it up again. If the problem persists, call your help desk, or call the VeriFone MRA desk.
- BAD RX COMMUN** The number of NAKs (no acknowledgements) sent from the terminal has exceeded the specified number. This indicates that the terminal is not receiving information from the host computer. Check your telephone connections and call the help desk to determine if they are aware of any problems.
- BAD TX COMMUN** The number of NAKs (no acknowledgements) sent from the host has exceeded the specified number. This indicates that the host computer is not receiving information from the TRANZ 330 terminal. Check your telephone connections and call the help desk to determine if they are aware of any problems.
- BELOW MINIMUM** The amount of sale entered is less than the programmed floor limit. It is therefore considered too small to require authorization from the host.
- BIRTHDAY MMDDYY** Enter the cardholder's birth date, using two digits each for month, day and year.
- BUSY** The terminal has its busy detect enabled and detects a busy tone.
- CALLING CENTER** The terminal is dialing the call center to obtain a voice authorization.
Wait until the terminal displays the "PICK UP HANDSET" prompt. Upon receiving this prompt, pick up the telephone handset and proceed with the voice authorization.
- CANNOT CONNECT** A failure of the terminal and host 1200 baud modems to get in sync.
- CARD ENTRY ONLY** The terminal is informing you it will only accept data from the cardreader.
Slide the card through the cardreader to enter the account number and expiration date.

Appendix C. Prompts and Error Messages

CHECK	This indicates a check authorization transaction. With the standard application, this prompt appears when you press the host check transaction keys 3, 6, or 9.
COMMUNICATING	The terminal is talking to ZONTALK.
CONNECTED	The unit has detected the carrier and is waiting for an ENQ.
CREDIT CARD	This indicates a credit card transaction. With the standard application, this prompt appears when you press host credit card transaction keys 1, 4 or 7.
D.C. MEMORY ERROR	The data capture memory is invalid. Contact your bank's service center for instructions.
DEMO APP XXXXX	The terminal is informing you it is performing a demonstration transaction. Press [CLEAR] to return to the idle state.
DIALING	The terminal is dialing a telephone number. Wait for the next prompt.
DIAGNOSTICS	The terminal is in the diagnostics mode. Press one of the diagnostic keys to begin a diagnostic test, or press [CLEAR] to return to the idle prompt. See Section 8 for the different diagnostics tests available.
DIALING 2ND NUM	The terminal is dialing the host's secondary telephone number. Wait for the next prompt.
DOWNLOAD?	The terminal wants confirmation that you wish to request a download. Press [FUNC/ENTER] to confirm you want a full download, or the [*] if you want a partial download. Press [CLEAR] to abort the operation. <i>Caution: A download will replace the information already stored in your terminal.</i>
DOWNLOAD DONE	The telephone download was successful.
DWNLD CANCELED	The telephone download was canceled. And, if the download computer is using ZONTALK software version 2.31 or earlier, the terminal's memory locations will be cleared. Use the RECALL function to verify that you have the correct download telephone number (location 000), the terminal serial number (location 001), and the application ID (location 019). Reenter the information if necessary and try the download again.
<EMPTY>	The recalled memory location is empty. If you are in the RECALL mode, you can press [BACKSPACE] and enter new information in the memory location. Press [CLEAR] to return to the idle state.

ENTER ACCOUNT #	Either slide the card through the cardreader, or manually enter the account number from the terminal's keypad.
ENTER CARD	Slide the card through the cardreader.
ENTER DATE MMY	Enter the expiration date on the card using two digits each for the month and year.
ENTER ID NUMBER	This is a fixed prompt that the terminal displays to request the entry of an identification number (i.e., driver's license or checking account number). Enter the appropriate identification number.
ENTER LAST 4 NUM	This is a fraud control feature. Use the keypad to enter the last four digits of the account number embossed on the card.
ENTER NEW PASSWD	The terminal is requesting a new system password to replace the existing one. Enter a new password followed by pressing the [FUNC/EDIT].
ENTER OLD PASSWD	The terminal is checking to see if you know the current password. Enter the password and press [FUNC/EDIT].
ENTER PASSWORD	You must enter the current password before you can continue. Enter the password or press [CLEAR] to cancel your operation.
ENTER STATE CODE	Enter the code for the desired state.
ENTER TRAN CODE	Enter the code for the desired transaction.
ENT PASSWD AGAIN	The terminal is confirming the password you just entered. Enter the password a second time.
EXPIRY DATE MMY	Enter the expiration date of the customer's card, using two digits each for the month and year.
FUNCTION?	You have selected the Function Menu. Press the desired terminal function key or press [CLEAR] to return to the idle prompt.
HOST DISCONNECT	The host sent an EOT (end of text) character before the transaction was complete. Press [CLEAR] and retry the transaction. Call the VeriFone Customer Service Hot ine if problems persist.

Appendix C. Prompts and Error Messages

INVALIDMEM SIZE	This is a direct download message that signals an incompatible EPROM (firmware) version. Verify that the application you are downloading is intended for the firmware version in your terminal.
INVALID PASSWORD	The password entered in the terminal does not match the password in memory.
KEY TEST	The terminal is in the key test mode. Press any key except for [CLEAR]. The terminal will display the pressed key in all 16 characters of the display. Press [CLEAR] to abort the test.
KEYBOARD ONLY	The terminal will only accept data entered from the keypad.
LOGGING IN	The terminal is logging into a network. Wait for the next prompt.
LOST COMM W/HOST	The host has unexpectedly dropped the carrier. Check your telephone connections, then retry the transaction. If the problem persists, call the help desk to see if there's a problem with the host. If the host is okay, you may have trouble with your telephone lines.
MEMORY TEST	The terminal is performing a memory test. The terminal will display random characters as the test proceeds. Allow the test to continue, or press and hold [CLEAR] to abort the test. If a memory error is indicated, return the terminal to customer service for repair.
MEMORY DIALER	The terminal needs to know which telephone number to auto-dial. Enter the memory location containing the telephone number you want to auto-dial.
MISMATCH DIGITS	The last four digits of the manually entered account number do not match the digits secured by the cardreader. Retry the transaction. If you receive this message again, you may have a fraudulent card. Follow the fraud procedures outlined by the card provider.
MULTI TRANS	The multi-transaction feature is enabled. Press the host/transaction key for the first transaction you want to process.
NO ANSWER	The terminal does not detect a carrier tone from the host computer. Retry the transaction. If the problem persists, call the host center to see if there's a problem with the host.
NO CARRIER	The terminal auto answers and does not detect carrier within 30 seconds.

- NO COMM W/ HOST** This indicates that there is no communication with the host computer. Check your telephone connections, then retry the transaction. If the problem persists, call the help desk to see if there's a problem with the host. If the host is okay, you may have trouble with your telephone lines.
- NO <CR> FRM HOST** The terminal did not receive the expected carriage return from the network. Retry the transaction. If the problem persists, call the host center to see if there's a problem with the network.
- NO ENQ FROM HOST** The terminal did not receive the expected ENQ character from the host within the specified period.
Retry the transaction again. If the problem persists, call the host center.
- NO ETX** The terminal displays this message during a cardreader test, informing you it failed to find the END SENTINEL on the customer's card.
The cardreader may have had a problem reading the card. Slide the card through the cardreader again. You may try sliding the card faster or slower. If the problem persists, call the VeriFone MRA desk.
- NO @ FROM HOST** The terminal was trying to login to a network, but did not receive the characters it expected.
Retry the transaction. If the problem persists, call the network center to see if there's a problem with the network.
- NO =FROM HOST** The terminal was trying to login to a network, but did not receive the characters it expected.
Retry the transaction. If the problem persists, call the network center to see if there's a problem with the network.
- NO LOGIN MSG** The terminal did not receive a request to login when it was trying to access a network.
Retry the transaction. If the problem persists, call the network center to see if there's a problem with the network.
- NO LOGIN SPEC** There is an "L" in the phone number and nothing after it. Use the RECALL or STORE function to add the number of the login string you want to access after the "L" in the phone number.
- NO MERCHANT ID** The terminal is informing you it cannot execute a transaction without the appropriate merchant ID.
Use the RECALL function to view the memory location of the merchant ID for the host transaction key you are using. Ensure the ID is correct. If the location is empty, enter the merchant ID.

Appendix C. Prompts and Error Messages

NO PASSWORD	<p>The password is missing from the login string. Use the RECALL or STORE function to include a login string with the correct password.</p>
NO RESOURCE ID	<p>The resource ID is missing from the login string. Use the RECALL or STORE function to include a login string with the correct resource ID. This prompt is used only for GEISCO network logins.</p>
NO RESP FR HOST	<p>The terminal is informing you it did not receive the required response from the host. Retry the transaction.</p>
NO SERIAL NUMBER	<p>The terminal's serial number is not correctly stored in the terminal's memory. Store the terminal serial number in the memory location 001.</p>
NO STX	<p>The cardreader did not detect the START SENTINEL on the card. The cardreader may have had a problem reading the card. Slide the card through the cardreader again. You may try sliding the card faster or slower. If the problem persists, call the VeriFone Customer Service Hot Line.</p>
NO TEL NUM	<p>No telephone number was stored for the host computer. Store the host telephone number in the appropriate memory location.</p>
NO USERNAME	<p>The username is missing from the login string. Use the RECALL function to view the login string and to store the correct login string.</p>
NOT 2ND GEN RESP	<p>The terminal is informing you that it received a response packet that was not programmed for second generation packet protocol. Ensure the message format flag is set to enable second generation protocol. Call the host center to see if the host is capable of performing second generation authorizations.</p>
ON HOOK	<p>The unit is currently on hook. If you are trying to make a call with the telephone, pick up the handset.</p>
OUT OF MEMORY	<p>There is not enough memory to store the data being entered. If you want to store new information, you must either clear out some of your data capture memory or some of the data in the memory locations. Remove any data you don't absolutely need (such as memory dial phone numbers) or unused login or control strings.</p>

- PARITY ERROR** The terminal displays this message during a cardreader test, informing you it detected a parity error in the card data.
The cardreader may have had a problem reading the card. Slide the card through the cardreader again. You may try sliding the card faster or slower. If the problem persists, call the VeriFone Customer Service Hot Line.
- PASSWORD?** The terminal's memory is password protected. You must enter the password before it will allow you enter the store mode. Enter the password.
- PICK UP HANDSET** The terminal is informing you it has made the requested telephone connection. Pick up the handset.
- PLEASE TRY AGAIN** The terminal could not read the card the first time it was swiped through the cardreader.
The cardreader may have had a problem reading the card. Slide the card through the cardreader again. You may try sliding the card faster or slower. If the problem persists, call the VeriFone Customer Service Hot Line.
- POST DIAL** The user has selected the option of having the terminal post dial.
- PRIVATE CARD** This indicates a private credit card authorization transaction. With the standard application, this prompt appears when you press the host private card transaction keys 2, 5, or 8.
- PROGRAMMING
ERR X** The terminal has detected bad data in the terminal's memory and will remain frozen until either memory is re-initialized or a programming error override is performed.
- READY** The terminal is informing you it is ready to perform a transaction.
Press a key to initiate the next desired transaction.
- RECALL WHAT?** The terminal needs to know which memory location it should recall.
Enter the three digit memory location number.
- RECEIVING** The terminal is receiving information from the host computer.
Wait for the next prompt.
- REDIALING** The terminal is redialing the telephone number because it did not get an answer the first time. Wait for the next prompt.
- RESERVED** The user has recalled a reserved memory location.
Press [CLEAR].

Appendix C. Prompts and Error Messages

SERIAL # NOT FND	The download computer has no record of you terminal's serial number. Use the RECALL function to verify that this number in location 001 matches the number on your terminal. After that, if you still receive this message, contact the person responsible for maintaining the download computer and the ZON-TALK software.
STORE WHAT?	The terminal needs to know which memory location you wish to store data in. Enter a three digit memory location number.
SUCCESSFUL	The terminal has received a complete download. Press [CLEAR] to return to the idle prompt.
SWIPE CARD NOW	The terminal is waiting for you to slide the card through the cardreader. Slide the card through the cardreader.
TCK ID # OR CARD	The terminal needs the ticket or card account number. Manually enter the ticket number at the terminal's keypad, or slide the card through the cardreader.
TRANSMITTING	The terminal is transmitting information to the host computer. Wait for the next prompt.
TRANZ 330 (version number)	This is the sign-on message. The alphanumeric code to the right of "TRANZ 330" is the firmware revision number. (model 212 "TRANZ 330 3E2CU2.10"; model 103 "TRANZ 330 3E2AU2.10") Wait for the terminal to display the idle prompt.
UNIT RECEIVE	The unit is ready to receive new memory contents from a master terminal.
UNIT RECEIVING	The unit is in process of receiving new memory contents.
UNIT SEND	The unit is ready to send all its memory contents to the slave terminal.
UNIT SENDING	The unit is in process of sending its memory contents.
UNREADABLE CARD	The cardreader cannot read the card's magnetic stripe because the card is damaged. Press [CLEAR] to return to the idle prompt. Sometimes, an unreadable card can be read by sliding it from the bottom to the top, rather than from the top to the bottom. If it is still unreadable, use the keypad to enter the account number manually .

UNSUCCESSFUL DL

The attempted download was not successful.

Retry the download. If the download is still unsuccessful, call the operator at the download center.

WAITING FOR ANSWER

The terminal has dialed a number and is waiting for the line to be answered.

Wait for the next prompt.

WAITING FOR LINE

The terminal cannot dial because the telephone line is in use or is not connected to the terminal.

Ensure the telephone line is properly connected to the terminal. Check to see if the attached telephone is off-hook or in use.

Appendix D. TRANZ 330 (202) Leased Line Terminal

This appendix contains reference information specific to the Bell 202 leased line version of the TRANZ 330 transaction terminal.

Operation of the leased line TRANZ 330 is virtually identical to that of the dial up terminal with the exception of terminal communications. The dial up TRANZ 330 terminal communicates with a host computer via the public telephone network; the TRANZ 330 (202) leased line terminal connects to a private, dedicated telephone network.

Devices attached to a private telephone network are systematically polled by the network controller and must respond with either an acknowledgment of poll receipt or a packet of data that is to be transmitted to the host. The major difference between the TRANZ 330 (202) and dial up versions of the terminal is that the terminal does not go off-hook to dial the host computer telephone number in a leased line environment.

The TRANZ 330 (202) currently supports two versions of Tinet leased line communication protocols: single terminal, or standard Tinet, and multi-terminal, or cluster Tinet. Differences between these versions are outlined in this appendix.

Basic Operation

Basic operation of the TRANZ 330 (202) leased line terminal is essentially the same as that of the dial up version. However, since a private leased line telephone network is used, all operations related to dialing phone numbers are no longer available.

Specifically, all terminal memory locations assigned to telephone numbers or associated with the operation of the unit's telephone interface in the dial up version of the terminal are general or reserved locations in the TRANZ 330 (202) version. These locations include:

Memory

Location	Dial Up Description
----------	---------------------

000	Download Phone Number
010	Dial Type Flag
011	Dial Speed Flag
012	Parallel Phone Available Flag
013	Number of Call Retries
014	Line Test Flag
015	Delay Before Auto Answer
020 - 029	Login String 0 - 9

TRANZ 330 Reference Manual

Memory Location	Dial Up Description
038	Auto Answer Control String
040 - 099	Memory Dialer Dial Strings
x00	Primary Phone Number
x01	Secondary Phone Number
x02	Call Center Phone Number
x03	Referral Phone Number
958	Bell/CCITT Select Flag
960	Dial-Up Line Download Speed
965	Auto Answer Speed
966	Auto Answer Processing Flag
967	Auto Answer Inactivity Timeout

Refer to the complete listing of TRANZ 330 (202) terminal memory locations on page D-7.

All TCL commands associated with the public telephone network or setting up the Bell or CCITT modems in dial up units, including the S, +D, +K, +M commands, and some options on several other commands, including the *K command, are unavailable. Refer to the TCL Programmer's Manual for availability of specific commands.

Entering Terminal Parameters

The TRANZ 330 terminal must be configured with the proper terminal specific parameters in memory locations 020, 021 and 960 to function properly on the leased line.

Poll Address TRANZ 330 (202) Version: Standard and Cluster

Memory Location: 020
Character Type: Numeric
Field Length: Up to 3 characters

This parameter is the address assigned to the terminal or terminal cluster on the multi-drop leased line. Valid poll addresses are as follows:

Standard	Cluster
1	32 to 47
3	96 to 111
5 to 15	
32 to 47	
64 to 79	
96 to 111	

Keyboard (KBD) ID TRANZ 330 (202) Version: Cluster

Memory Location: 021
Character Type: Numeric
Field Length: 1 character

Support for terminal clustering has been added as an enhancement to the cluster version of the TRANZ 330 (202). This feature enables up to 4 terminals to share a common poll address. The Keyboard ID parameter is

used by the network controller to distinguish between multiple terminals on the cluster.

The valid range for this parameter is from 0 (or <empty>) to 3 with the default being 0 (cluster "master").

Note: Only the master terminal on the cluster provides the "NO DATA" response to poll from the controller. A terminal's data response to poll is windowed at intervals of 50 milliseconds based on its keyboard ID. For proper operation of the cluster, it is imperative that there be only one master terminal (KBD ID = 0) and that there be no duplication of keyboard IDs anywhere in the cluster.

Poll Timeout Period TRANZ 330 (202) Version: Cluster

Memory Location: 960

Character Type: Numeric

Field Length: Up to 2 characters

If the terminal does not receive a poll from the network controller within a specified period of time, it displays the message NO POLLS RCVD, indicating that either the leased line is down or the network controller or the specific terminal affected is inoperative.

The timeout period in the cluster version of the leased line TRANZ 330 can be modified by the user via the keyboard "STORE" function by storing the desired poll timeout value in location 960. The range for this parameter is from 1 to 65 seconds with 0 or <EMPTY> specifying the default poll timeout.

The default "no poll" timeout is 45 seconds for both protocol versions of the terminal .

Downloading

The TRANZ 330 (202) supports both direct (terminal-to-terminal) and leased line downloads. Direct downloading of the leased line TRANZ is identical in function and procedure to the dial up version of the terminal as described in section 3, page 3-4 of this manual.

Due to existing capabilities of the specific host processors, the leased line download protocol employed by the two different versions of the TRANZ 330 (202) differ significantly and are not compatible. Download procedures differ for each version.

Tinet Standard Leased
Line Download

The standard leased line download provides both full and partial downloads. Under this protocol, a full download is defined as a download of a DIFFERENT version of the application than that currently in the terminal. A partial download is a redownload of the application currently in the terminal. Under both download procedures all terminal memory locations are reprogrammed with updated information from the host.

Use the following procedure to initiate a download on a terminal supporting Tinet standard.

Display	Response
1. (idle prompt)	Press [FUNC/ENTER].
2. FUNCTION?	Press [0].
3. FULL/PART? F/P	Press [F] if you wish to perform a download of a different application version. Press [P] if you wish to perform a download of the current application.
4. VERSION NUMBER?	This prompt requests the input of the two digit version number of the application to be downloaded if a full download is being performed. This prompt is not displayed for partial downloads.
5. PROCESSING	Wait - the download is in progress.
6. DOWNLOAD DONE or	The terminal successfully completed the download. Press the [CLEAR] key to return to the idle prompt.
DOWNLOAD FAILED	The terminal was unable to complete the download. This could be due to a bad leased line or other problems not related to the terminal. Press [CLEAR] and try the download procedure again.

**Tinet Cluster Leased Line
Download**

Tinet cluster leased line download currently supports only partial downloads in which RAM is not cleared prior to the download process. Memory locations change contents only if the host provides new information.

Use the following procedure to initiate a download on a terminal supporting Tinet clusters.

Display	Response
1. (idle prompt)	Press [FUNC/ENTER].
2. FUNCTION?	Press [0].
3. DOWNLOAD?	Press either [FUNC/ENTER] or [*] to start the application download process.
4. DOWNLOADING	Wait - the download is in progress.
5. DOWNLOAD DONE or	The terminal successfully completed the download. Press the [CLEAR] key to return to the idle prompt.
DOWNLOAD FAILED	The terminal was unable to complete the download. This could be due to a bad leased line or other problems not related to the terminal. Press [CLEAR] and try the download procedure again.

Host Initiated or Forced Downloads

The Cluster TRANZ 330 (202) also supports host initiated or forced downloads in which the terminal receives a command from the network controller that instructs it to begin the download process automatically. If the terminal is in the idle state when this command is received, it will automatically begin the download process beginning with step 4. If the terminal is not in the idle state, for example, if it is running a local function, the download will begin with step 4 as soon as the terminal returns to the idle state.

Maintenance/Diagnostics

Enhanced diagnostic capability has been added to the cluster version of the TRANZ 330 (202) to assist in troubleshooting problems specific to leased line terminals. Refer to page 5-9 for instructions on placing the terminal in the Diagnostics Mode. The following diagnostic options are available in cluster TRANZ 330 (202) terminals:

Key	Function
[5]	Initialize NAK Counter
[6]	Display NAK Counter
[9]	Tx/Rx Status Display
[*]	Leased Line Integrity Test

NAK Counter

The NAK Counter allows you to determine the terminal's capability to conduct error free communications with the network controller by tabulating the number of NAKs that are either transmitted or received during the processing of normal transactions.

Press [5] to initialize the NAK counter from the Diagnostic Mode. The message NAK COUNT INIT will be displayed for two seconds indicating that the NAK counter has been successfully initialized to zero. The terminal then returns to the DIAGNOSTIC prompt.

Enter the Diagnostics Mode and press [6] to determine how many NAKs occurred after running several transactions on the leased line. The terminal will display NAK COUNT = xx where xx is the number of NAKs that were either transmitted or received since the NAK counter was initialized. After 2 seconds the unit returns to the DIAGNOSTICS display.

Note: The NAK counter is a one byte value and can count the number of NAKs up to 255 without cycling through 0 again.

Tx/Rx Status Display

Enter the Diagnostics Mode and press [9] to enable the Tx/Rx status display. While in this mode, a message "TX ON" will indicate that the unit is responding to poll. The message "TX OFF" shows that the terminal's Bell 202 modem is in receive mode. Press any key to return to the "DIAGNOSTICS" display.

Note: Since the master terminal in a terminal cluster is the only device which provides the "no data" response to poll, only a master terminal will show the "TX ON" message.

Leased Line Integrity Test

Press [*] from the DIAGNOSTICS display to initiate the Leased Line Integrity Test. The message "TESTING LINE" will be displayed for 5 seconds. During this period, the number of data reception errors (parity errors, data overruns, etc.) will be recorded. Following this 5 second test, either a "LINE

OK" message indicating that no data receive exceptions occurred, or the message "ERROR CNT = xx" where xx is the number of errors that occurred in the testing interval will be displayed.

After a two second delay, the terminal will return to the Diagnostics Mode.

Programming Considerations

Very little modification should be necessary to download an application from a dial up TRANZ 330 to either version of the leased line terminal other than proper configuration of the terminal itself. This task, however, will be more difficult and time consuming for applications that make extensive use of the special TCL commands associated with the telephone or Bell 103/212 modem interface .

Standard TRANZ 330 (202)

When writing an application (or converting an existing one) for execution on the standard TRANZ 330 (202), you should be aware of the following differences from dial up terminal operation:

1. The terminal prohibits execution of host transactions when it is in the NO POLLS RCVD condition.
2. The initiation of a host transaction does not begin with a <STX> in the transmit buffer. The transmit buffer is completely cleared when a transaction begins.
3. The data packet received from communications with the host and returned to the application level is stripped of its packet header (<STX>) and trailer (<ETX><LRC>).

Cluster TRANZ 330 (202)

When writing an application (or converting an existing one) for execution on the cluster TRANZ 330 (202), you should be aware of the following differences from dial up terminal operation:

1. The terminal prohibits execution of host transactions when it is in the NO POLLS RCVD condition.
2. The initiation of a host transaction does not begin with a <STX> in the transmit buffer. Instead, the transmit buffer is completely cleared when a transaction begins.
3. The data packet received from communications with the host and returned to the application level is the complete packet received including its packet header (<STX>) and trailer (<ETX><LRC>).

Protocol Consideration

The data transmitted from the terminal to the host under the Tinet protocol has the following format:

<STX><KBD><TC><SEQ>....data....<ETX><LRC>

where <STX> = Start of Text (02 hex)
 <KBD> = Keyboard ID
 <TC> = Tran code
 <SEQ> = Sequence Number
 <ETX> = End of text (03 hex)

For both versions of the TRANZ 330 (202) the <STX>, <ETX>, and <LRC> characters are provided by the operating system and these characters should not be present in the application transmit buffer when it is passed along to the EPROM communication routine.

The data transmitted from the host to the terminal is formatted as follows:

<STX><KBD><SEQ>....data....<ETX><LRC>

Standard TRANZ 330 (202)

Although the operating system automatically provides the appropriate transaction sequence number and a constant value of 40 Hex for the keyboard ID (KBD), space within the transmit packet must be reserved for these values at the application level. Also, in the Standard version, the tran code must be provided by the application. Therefore, the application transmit buffer should be of the following form for proper communication to occur:

<X><TC><X>....data....

where <X> is any single character.

For the Standard TRANZ 330 (202), the <STX>, <ETX>, and <LRC> characters are stripped from the data when it is received into the application level receive buffer.

Cluster TRANZ 330 (202)

The only data required to be in the application transmit buffer prior to communication is the data portion of the packet. The keyboard ID (KBD as defined by location 021), a constant tran code of 30 hex, and the transaction sequence number, are automatically inserted into the transmit packet by the operating system.

For data received from the host, all data received is available at the application level including the <STX>, <ETX>, and <LRC>.

Error Messages

The following error messages are either specific to the TRANZ 330 (202) terminals or have meanings other than those already documented in Appendix C.

PROCESSING	Indicates that the communications dialog has begun.
BAD TX COMM	Indicates that the transmit timeout elapsed during the transmit portion of the communications dialog or that the host responded to the message with an ENQ or some unrecognized character.
BAD RX COMM	A problem occurred during the receive portion of the communications dialog. This means that three packets with invalid LRCs were received and NAKed by the terminal.
NO RESP FRM HOST	The receive or transmit timeout elapsed without a data packet being properly transmitted or received.
REMOTE LOOPBACK	(Standard only) The communications dialog was interrupted by a Remote Loopback request message from the host.
INVALID POLL ID	The poll address in memory location 020 is invalid.
INVALID KBD ID	(Cluster only) The keyboard ID in memory location 021 is invalid.
NO POLLS RCVD	The poll timeout period has expired without receiving a network poll or select. Default = 45 seconds. User settable for cluster version (location 960).

TRANZ 330 Reference Manual

Memory Locations

In addition to memory location numbers and descriptions, this numeric listing also includes character type and field lengths for the TRANZ 330 (202) memory locations.

The field length indicates the maximum number of characters that can be stored in the memory location.

Memory Location	Character Type*	Field Length	Description
000	X	20	General Location
001	X	10	Serial Number
002	-	--	Transmit Buffer
003	-	--	Receive Buffer
004	9	6	Program Date
005	9	4	Message Sequence Number
006	9	2	Number of Characters to Scroll
007	9	1	Multiple Transaction Timeout
008	9	5	Reserved
009	9	1	Beeper On/Off
010	9	1	Reserved
011	9	1	Reserved
012	9	1	Reserved
013	9	1	Reserved
014	9	1	Reserved
015	9	3	Reserved
016	X	120	Encrypted Working/Master Key Pointer
017	9	1	RECALL, Clock, Unit-to-Unit Restriction
018	9	16	Error Statistics
019	X	7	Application Identification
020	9	3	Poll Address
021	9	1	Keyboard ID (cluster only)
022 - 029	X	60	General Locations 22 to 29
030	X	16	Idle Prompt
031	X	120	Function Key # 1 Control String
032	X	120	Function Key # 2 Control String
033	X	120	Function Key # 3 Control String
034	X	120	Function Key # 4 Control String
035	X	120	Function Key # 5 Control String
036	X	120	Function Key # 6 Control String
037	X	120	Out of Memory Control String
038	X	120	General Location
039	X	120	Function Key # 9 Control String
040 - 099	X	120	General Locations 40 to 99
100	X	20	General Location
101	X	20	General Location

*X = alphanumeric; 9 = numeric

Appendix D. Leased Line Terminal

Memory Location	Character Type*	Field Length	Description
102	X	16	General Location
103	X	16	General Location
104	X	46	Merchant/Terminal ID
105	9	3	Message Format Flag
106	9	3	Fraud Control Flag
107	X	120	Transaction Control String
108	X	16	Transaction Type Prompt
109	9	4	Floor Limit
110	X	120	Response Analysis Control String
111	X	120	Auxiliary Control STring
112	9	1	Multi-Transaction Group Code
113 - 199	X	120	General Locations 113 to 199
200	X	20	General Location
201	X	20	General Location
202	X	16	General Location
203	X	16	General Location
204	X	46	Merchant/Terminal ID
205	9	3	Message Format Flag
206	9	3	Fraud Control Flag
207	X	120	Transaction Control String
208	X	16	Transaction Type Prompt
209	9	4	Floor Limit
210	X	120	Response Analysis Control String
211	X	120	Auxiliary Control STring
212	9	1	Multi-Transaction Group Code
213 - 299	X	120	General Locations 213 to 299
300	X	20	General Location
301	X	20	General Location
302	X	16	General Location
303	X	16	General Location
304	X	46	Merchant/Terminal ID
305	9	3	Message Format Flag
306	9	3	Fraud Control Flag
307	X	120	Transaction Control String
308	X	16	Transaction Type Prompt
309	9	4	Floor Limit
310	X	120	Response Analysis Control String
311	X	120	Auxiliary Control STring
312	9	1	Multi-Transaction Group Code
313 - 399	X	120	General Locations 313 to 399
400	X	20	General Location

*X = alphanumeric; 9 = numeric

TRANZ 330 Reference Manual

Memory Location	Character Type*	Field Length	Description
401	X	20	General Location
402	X	16	General Location
403	X	16	General Location
404	X	46	Merchant/Terminal ID
405	9	3	Message Format Flag
406	9	3	Fraud Control Flag
407	X	120	Transaction Control String
408	X	16	Transaction Type Prompt
409	9	4	Floor Limit
410	X	120	Response Analysis Control String
411	X	120	Auxiliary Control String
412	9	1	Multi-Transaction Group Code
413 - 499	X	120	General Locations 413 to 499
500	X	20	General Location
501	X	20	General Location
502	X	16	General Location
503	X	16	General Location
504	X	46	Merchant/Terminal ID
505	9	3	Message Format Flag
506	9	3	Fraud Control Flag
507	X	120	Transaction Control String
508	X	16	Transaction Type Prompt
509	9	4	Floor Limit
510	X	120	Response Analysis Control String
511	X	120	Auxiliary Control STring
512	9	1	Multi-Transaction Group Code
513 - 599	X	120	General Locations 513 to 599
600	X	20	General Location
601	X	20	General Location
602	X	16	General Location
603	X	16	General Location
604	X	46	Merchant/Terminal ID
605	9	3	Message Format Flag
606	9	3	Fraud Control Flag
607	X	120	Transaction Control String
608	X	16	Transaction Type Prompt
609	9	4	Floor Limit
610	X	120	Response Analysis Control String
611	X	120	Auxiliary Control STring
612	9	1	Multi-Transaction Group Code
613 - 699	X	120	General Locations 613 to 699

*X = alphanumeric; 9 = numeric

Appendix D. Leased Line Terminal

Memory Location	Character Type*	Field Length	Description
700	X	20	General Location
701	X	20	General Location
702	X	16	General Location
703	X	16	General Location
704	X	46	Merchant/Terminal ID
705	9	3	Message Format Flag
706	9	3	Fraud Control Flag
707	X	120	Transaction Control String
708	X	16	Transaction Type Prompt
709	9	4	Floor Limit
710	X	120	Response Analysis Control String
711	X	120	Auxiliary Control STring
712	9	1	Multi-Transaction Group Code
<hr/>			
713 - 799	X	120	General Locations 713 to 799
<hr/>			
800	X	20	General Location
801	X	20	General Location
802	X	16	General Location
803	X	16	General Location
804	X	46	Merchant/Terminal ID
805	9	3	Message Format Flag
806	9	3	Fraud Control Flag
807	X	120	Transaction Control String
808	X	16	Transaction Type Prompt
809	9	4	Floor Limit
810	X	120	Response Analysis Control String
811	X	120	Auxiliary Control String
812	9	1	Multi-Transaction Group Code
813 - 899	X	120	General Locations 813 to 899
900	X	20	General Location
901	X	20	General Location
902	X	16	General Location
903	X	16	General Location
904	X	46	Merchant/Terminal ID
905	9	3	Message Format Flag
906	9	3	Fraud Control Flag
907	X	120	Transaction Control String
908	X	16	Transaction Type Prompt
909	9	4	Floor Limit
910	X	120	Response Analysis Control String
911	X	120	Auxiliary Control STring
912	9	1	Multi-Transaction Group Code
<hr/>			
913 - 949	X	120	General Locations 913 to 949

*X = alphanumeric; 9 = numeric

TRANZ 330 Reference Manual

Memory Location	Type*	Length	Description
950	9	1	Printer Type Flag 0 = No Printer 1 = Generic Roll Printer 2 = Printer 200 (Citizen) 3 = Printer 100 (Slip Printer)
951	9	3	Number of Line Feeds for P200 6=default
952	9	1	Baud Rate for Generic Printer 0 = 300 (Default) 1 = 600 2 = 1200 3 = 2400 4 = 4800 5 = 9600 6 = 19200
953	9	1	Data Format - Generic Printer 0 = 7 data, even parity, 2 stop 1 = 8 data, no parity, 2 stop
954	9	1	Handshake - Generic Roll Printer 0 = Hardware (Default) 1 = None
955 - 959	X	60	Reserved
960	9	3	Poll Time Out Value (cluster only) 1..255 Seconds Default = 45 Seconds
961 - 969	X	120	Reserved
970	9	1	DIN 6 Peripheral 0 or <empty> = Nothing Connected 1 = Bar Code Wand, 2 = PIN Pad 3 = General Communication Device
<i>Warning: If you select "2" to indicate a PIN Pad connection and a PIN Pad is not attached, there will be a delay when you press [CLEAR] because the terminal will still attempt to reset the PIN Pad three times before resuming normal processing.</i>			
971 - 979	X	60	Reserved
980	X	120	Delay Executing Idle Loop CS 0 or <empty> = Disabled
981	X	120	Idle Loop Control String
982	X	60	Reserved

*X = alphanumeric; 9 = numeric

Appendix D. Leased Line Terminal

Memory Location	Type*	Length	Description
983	X	120	Idle Loop Response Analysis CS
984	X	60	Idle Loop Inactivity Timeout
985	9	1	Host # for Card Initiated Trans
986	9	1	Host # for Bar Code Init. Trans
987 - 989	X	60	Reserved
990	X	120	Commun Error Control String
991 - 996	X	60	Reserved
997	X	120	VFI Diagnostic Control String
998	X	60	Reserved
999	X	60	Programming Error Recovery Log

*X = alphanumeric; 9 = numeric

Glossary

AC	Alternating Current--used as a primary source of power by power packs and power supplies.
Access Code	A code number dialed to gain access to a telephone line, such as the number "9" dialed to reach an outside line.
Alpha mode	A means of allowing you to use the keypad to enter alphabetic characters.
Alphanumeric	Capable of utilizing both alphabetic and numeric characters such as a terminal display or keypad or a computer keyboard.
Application	A program consisting of special codes stored in memory used to control a terminal and its operations.
Application ID Number	The number identifying which application is to be downloaded by the ZON-TALK software from an IBM PC compatible computer.
Bar Code	A series of vertical stripes on a label used to identify an item.
Baud	The signaling speed equal to the number of signal events per second. Not necessarily the same as bits per second.
Buffer	An electronic device within the terminal that allows for the temporary storage of data.
Cable Routing Channels	Grooves molded to underside of terminal for relocating cables.
Cardreader	The slot on the top of the terminal that automatically reads the magnetic stripe on the back of a credit or bank card.
Calendar/Clock Chip	An electronic component in the TRANZ 330 terminal that keeps track of the data and time.
Character	A letter, number, punctuation, figure or other symbol used in a message or in a control function.

Custom Application	An application created to meet the specialized needs of an individual company or institution.
Custom Prompts	Information on the display panel created specially for a particular company or user.
Data	Information used by the terminal that relates to a specific transaction or operation.
Debit Card	Used in many of the same transactions as a credit card except no credit is given and the holder must have funds in his or her account to immediately cover the transaction.
Diagnostics	The procedure for detecting and isolating a problem or malfunction with the TRANZ 330.
Display	The small screen on your terminal directly above the keypad; this screen displays prompts and messages to guide you through transactions.
Download	The process of transferring data from one computer or terminal to another.
EPROM	Read only memory permanently stored in the TRANZ 330 terminal. Contains the standard application and operating system.
File	A collection of logically related records.
Firmware	The basic instructions built into the TRANZ 330, stored in ROM and executed automatically.
Flag	A programmed indicator such as a character or digit used for identification.
Fraud Control	Measures taken to prevent unauthorized use of a credit or debit card.
Host	An authorization center computer used to process transactions; also called a host computer.
Host Transaction Keys	Keys 1 through 9 on the keypad. Pressing one of these keys begins the transaction assigned to that key.
Host Transactions	Transactions performed by communicating with a host computer.
Host Parameters	Parameters related specifically to transactions with a host computer.

Idle Prompt	The information shown on the display panel when the terminal is not performing any operations or transactions. Normally the date and time.
Keypad	The 16 key panel on the TRANZ 330. Used for entering data and operating the terminal.
Leased Line	A private telephone line connected directly to another line.
Local Functions	Operations performed at the terminal location only and not with a host computer. Up to seven are permitted and these are accessed by pressing the [FUNC/ENTER] key followed by the desired function key.
Login String	A code consisting of a network code, user name and password, used to log onto a network.
Luhn Check-Digit	A fraud control measure used in transactions.
Manual Transaction	Transaction using account information entered from the keypad rather automatic reading devices such as the card reader.
Memory	The storage of codes and data in the circuitry of a terminal or computer or other media such as magnetic disk or tape.
Memory Dialing	A method of automatically dialing telephone numbers stored in the terminal's memory rather than dialing by hand.
Memory Locations	The segments used to divide the TRANZ 330 terminal's memory. Identified by a three-digit location number.
Merchant ID Number	Number used by merchants to identify themselves and their terminal to host computer at their bank or financial institution. Also called terminal ID.
Messages	Words and symbols appearing on the terminal's display which tell you the kind of information required, the result of a process, an error has occurred.
Modem	Short for modulator/demodulator; a device that converts electronic data to audio signals (for transmission over telephone wires) and audio signals back to electronic data.
Multiple Transactions	The capability of performing several transactions during a single call to a host computer.
Network	A service that routes numerous transactions and data to the proper terminals and host computers.

Packet Switched Networks	Networks that divide information into packets so host computer processing time is evenly distributed among different users.
Parameters	Information stored in memory that configures the terminal for use with transactions and other operations.
Password	A confidential code used to gain access to a host computer.
PC	IBM PC or compatible personal computer used to download applications and data to the TRANZ 330 terminal.
POS Terminal	A terminal used at the point-of-sale (POS) that can process transactions and communicate transaction information with a larger remote computer.
Post Dialing	A feature that dials the host computer after all of the account and transaction information is entered into the terminal.
Power Pack	A device that converts a voltage to a different level so it can be used by a particular device.
Printer	A device used for imprinting records of a transaction on paper.
Prompt	A message appearing on the terminal's display telling you what action is required or what type of information to specify.
Pulse Dialing	A method of telephone dialing that specifies a phone number by the number of electrical pulses sent.
RAM	Random access memory used to store custom applications and temporary data entered during a transaction.
RECALL	Procedure used to display data in a memory location. RECALL can also be used to add or change data.
ROM	Read only memory permanently stored in the TRANZ 330 terminal. Contains the standard application and operating system.
Scroll	To move text across a display screen.
Serial Port	Circuitry in the TRANZ 330 terminal with an 8-pin DIN connector for communicating with download computers, other terminals, and printers.

Standard Application	The application provided with each TRANZ 330 terminal. You can override the standard application by downloading a custom application into the terminal.
Standard Password	The password supplied with each terminal. This number, "Z66831," should be changed to a confidential number.
Standard Telephone	A Bell compatible telephone. A telephone can be connected directly to the TRANZ 330 terminal for use on the same telephone line.
STORE	Procedure used to store data in a memory location.
Swipe	The action of sliding a card through the card reader.
Telephone Jack	Modular type sockets for connecting telephone line cords and handsets.
Telephone Line	The standard telephone wiring connecting you to your local or private telephone company.
Terminal	The main component in your credit card authorization system; the terminal processes requests and allows you to initiate transactions (see also POS terminal).
Terminal Control Language (TCL)	A proprietary programming language designed by VeriFone for programming the VeriFone TRANZ and XL family of terminals.
Terminal Parameters	Parameters related to a specific terminal.
Tone Dialing	A method of telephone dialing that uses different pitched tones to specify a phone number.
Track 2 Data	American Bankers Association information stored on track 2 on the credit card magnetic stripe.
Transaction Key	A software key used by the TRANZ 330 terminal to encrypt PINs (personal identification numbers) before they are sent to the host computer. The TRANZ 330 terminal first receives encrypted transaction keys from the host and decrypts them using a master key.
Transaction Data Formats	Also called message formats. Includes 16 standard formats built into the TRANZ 330 terminal commonly used to send data to the host computer.
Wand	A hand-held optical scanning device that reads bar code information.

ZONTALK A communications program for IBM PC compatible computers used to download applications from the computer to a terminal.

Index

A

- Abort control string 6-12
- ALPHA/MULTI key 5-8
- Alphanumeric data 5-3
- Application
 - custom 4-2
 - program 4-2
 - standard 4-2
- Application Code 3-1
- Application ID 6-7
- Auto answer 6-8
- Auto answer processing 6-11
- Auto answer speed 6-10
- Autonet 7-8
- Auxiliary control string 7-7

B

- Bar Code Wand 1-3 - 1-4, 2-5
 - troubleshooting 8-2
- Bar code wand test 8-6
- Baud rate 6-10
 - generic printer 6-9
- Beep 6-4
- Bell/CCITT Mode 6-10
- Busycomm 7-8

C

- Cable routing channels 1-3, 2-7
- Calendar/Clock
 - resetting 5-9
- Card reader
 - operation 5-1
- Card reader test 8-6
- Cardreader 5-1
 - ABA track 2 1-2

- ISO track 1 1-2
 - usage 1-2

- Compuserve 7-8
- Connet 7-8
- Control String
 - auxiliary 7-7
 - communication error 6-13
 - linking 7-6
 - response analysis 7-7
 - transaction 7-6

D

- Data format
 - generic printer 6-9
- Datapac 7-8
- Diagnostics
 - bar code wand test 8-6
 - card reader test 8-6
 - display test 8-5
 - memory test 8-4
- Dial speed flag 6-5
- Dial type flag 6-5
- Dial-up line
 - upload/download speed 6-10
- Direct PC download 3-4
- Display messages
 - diagnostics 8-5
- Display panel 1-2
 - troubleshooting 8-2
- Download
 - direct PC 3-4
 - full 3-5
 - master terminal 3-2
 - partial 3-5
 - phone number 6-2

Index

D

- slave terminal 3-3
- telephone 3-7
- terminal-to-terminal 3-1

E

- Error codes 5-12
- Error condition
 - display and override 5-13
- Error condition recovery 5-12
- Error messages 8-1

F

- Floor limit 7-6
- Fraud control 7-5
- Free memory reclamation 6-12
- Full download 3-5

G

- Geisco 7-8

H

- Handshake
 - generic printer 6-9
- Host
 - bar code transactions 6-13
 - card transactions 6-13
- Host transactions 4-1

I

- Idle loop 6-12
- Idle prompt 5-1, 6-7

K

- Keypad 1-2
 - diagnostics 8-4
 - entering alphanumeric data 5-3
 - programming 4-3
 - troubleshooting 8-3

L

- Line recovery time 6-12
- Local functions 4-2
- Local transactions 4-2
- Login strings 7-8
- Luhn check-digit 7-4

M

- Master terminal 3-2
- Memory
 - locked, unlocked 5-5
 - re-initialization 5-13
- Memory dial phone numbers 6-8
- Memory dialing 5-2
- Memory locations 4-3
- Memory test 8-4
- Merchant identification number 7-4
- Message format flag
 - See Transaction format flag
- Message sequence number 6-3
- Modem 1-4
 - Bell (optional) 1-4
 - CCITT V.21/V.22 300 baud 1-4
 - leased-line (standard) 1-4
- Multiple transaction
 - timeout 6-4

Index

M

Multiple transaction function 5-7
Multiple transactions 4-5

N

Nabanco/Western Union 7-8
Network
 codes 7-8
Network code 7-8
Networks 4-5

O

Options
 bar code wand 1-4, 2-5
 cable routing channels 2-7
 PIN Pad 1-5, 2-5
 telephone 1-4
Out of memory control string 6-7

P

Paper advance 6-9
Parameter data 3-1
Parameters
 entering Terminal/Location
 parameters 6-2
Partial download 3-5
Password
 changing system password 5-11
 lost 5-11
 system 3-3
Password protection 6-7
Pause character 7-2
PIN Pad 1-3, 1-5
 connection 2-5
 troubleshooting 8-2

PIN Pad/Bar Code Wand serial
port 6-11
POST function 5-8
Power pack 1-3, 2-6
Primary phone number 7-2
Printer
 Printer 250/600 paper advance 6-9
 selection 6-8
 troubleshooting 8-2
Printer 150 1-3, 2-2, 6-8
Printer 250 1-4, 2-3
Printer 250 Connections 2-4
Printer 250/600 6-8
Printer 6000 Connections 2-4
Procedure
 cable routing channels 2-7
 connect bar code wand 2-5
 connect PIN Pad 101 2-5
 connect PIN Pad 201 2-5
 connect power pack 2-6
 connect Printer 150 2-2 - 2-3
 connect Printer 250 2-3
 connect standard telephone 2-2
 connect telephone line 2-2
 unpacking terminal 2-1
Program date 6-3
Programming error recovery 5-12

R

RAM 4-3
RECALL function 5-6
 adding and changing information
5-7
 displaying information 5-6
Referral phone number 7-3

Index

R

Response analysis control string 7-7
Restriction flags
 set clock,RECALL, Unit-to-Unit 6-7
ROM 4-3

S

Scroll length 6-4
Secondary phone number 7-2
Serial number 6-3
Serial Port
 PIN Pad/Bar Code Wand select 6-11
Serial ports
 PIN Pad/Bar Code Wand 1-3
 printer 1-3
Slave terminal 3-3
STORE function 5-4
System password
 changing 5-11

T

TCL (terminal control language) 7-6
Telenet 7-8
Telephone 1-4
 dial type 6-5
 memory dial phone numbers 6-8
 memory dialing 5-2
 troubleshooting 8-2
Telephone connection 2-2
Telephone download 3-5
Telephone jacks 1-3
Terminal ID
 See Merchant identification number

Terminal parameters 4-4, 6-1
Thermal paper 2-4
Timeout
 auto answer inactivity packet 6-11
Tone/Pulse dialing 6-5
Transaction
 Auxiliary control string 7-7
 floor limit 7-6
 fraud control flag 7-5
 login strings 7-8
 merchant identification number 7-4
 parameters 7-1
 primary phone number 7-2
 referral phone number 7-3
 response analysis control string 7-7
 secondary phone number 7-2
 Transaction format flag 7-4
 transaction type 7-6
Transaction 7-6
Transaction keys 5-1
Transaction parameters 4-4, 7-1
Transaction simulation
 cardreader entry 8-7
 keypad entry 8-7
Transactions
 local 4-2
TRANZ 330
 Test Flag 6-6
 application code 3-1
 application ID 6-7
 cleaning 8-1
 diagnostics 8-4
 dial speed flag 6-5
 downloading 3-1
 idle prompt 5-1, 6-7

Index

T

- master/slave considerations 3-2
- out of memory control string 6-7
- parameter data 3-1
- returning for service 8-1
- serial number 6-3
- startup 5-1
- transaction keys 5-1
- unpacking 2-1
- Troubleshooting 8-1
- Tymnet 7-8

U

- Unpacking terminal 2-1

V

- ZONTALK 3-6
- VISA
 - first generation transactions 7-4
 - second generation transactions 6-3
- Voice authorization code 7-3

Z

- ZONTALK
 - direct PC download 3-4
 - telephone download 3-5

Free Manuals Download Website

<http://myh66.com>

<http://usermanuals.us>

<http://www.somanuals.com>

<http://www.4manuals.cc>

<http://www.manual-lib.com>

<http://www.404manual.com>

<http://www.luxmanual.com>

<http://aubethermostatmanual.com>

Golf course search by state

<http://golfingnear.com>

Email search by domain

<http://emailbydomain.com>

Auto manuals search

<http://auto.somanuals.com>

TV manuals search

<http://tv.somanuals.com>