

# Four-Line Caller ID Telephone



**NSQ412**

OWNER'S MANUAL

Download from [Www.Somanuals.com](http://www.Somanuals.com). All Manuals Search And Download.

**Qwest**<sup>®</sup>

*Spirit of Service*<sup>™</sup>

FCC INFORMATION .....	1	Redial and (Auto)Redial.....	20
IMPORTANT SAFETY INSTRUCTIONS.....	2	Prime Line Preference.....	21
INTRODUCTION.....	4	CO Line Privacy.....	21
The NSQ412 System Features.....	4	Intercom Operation.....	21
The Box Contents .....	5	Paging Operation.....	22
Key and Indicator Descriptions.....	6	Interchanging the Intercom and Page.....	22
GETTINGSTARTED.....	10	Paging All Stations.....	23
Installation Preparation.....	10	Mute Operation.....	23
Installing the Telephone on a Desk or Table.....	12	Pause Operation.....	23
Installing the Telephone on a Wall.....	13	Flash Key Operation.....	23
Basic Features.....	16	Temporary Tone Dialing.....	23
LED Illumination.....	16	Conference Operation.....	24
Ringer Status.....	17	Do Not Disturb Operation.....	24
Intercom Tone Status.....	17	The Volume Key Operation.....	24
Station Initialization.....	17	Battery Low Warning.....	24
Answering a Call.....	18	POWER FAILURE OPERATION.....	25
Making a Call.....	18	Line Status Indication.....	25
Switching Between Handset, Handsfree and Headset.....	19	Disabling Unused Lines.....	25
Call Timer Operation.....	19	Non-Square Operation.....	25
Hold Operation.....	20	ADVANCED FEATURE OPERATION.....	26
Transferring a Call to Another Station.....	20	Viewing the Directory.....	26
Release Operation.....	20	Programming the Directory.....	26

# Table of Contents

Viewing a Directory Entry.....	28	Time and Date Programming.....	40
Editing a Directory Entry.....	28	Programming the Station Number.....	41
Dialing a Directory Entry.....	29	Message Waiting Indicator Programming.....	41
Erasing a Single Directory Entry.....	29	Ringer On or Off Programming.....	42
Erasing All Public or Private Directory Entries.....	29	Ringer Type Programming.....	43
Viewing a Speed Dial Entry.....	30	Delayed Ring Programming.....	44
Editing a Speed Dial Entry.....	30	Line Usage Programming.....	44
Dialing a Speed Dial Entry.....	31	Prime Line Preference Programming.....	45
Erasing a Speed Dial Entry.....	31	Line Group Programming.....	45
CALLER ID OPERATION.....	31	Auto-Mute Programming.....	46
Setting Up the Caller ID Operation.....	32	Tone or Pulse Dial Programming.....	47
Receiving Caller ID.....	32	Flash Time Programming.....	47
Viewing the Caller ID List.....	34	Hold Reminder Programming.....	48
Erasing All Caller ID Records.....	34	New CID LED Programming.....	48
Erasing a Single Caller ID Record.....	34	Area Code Programming.....	48
Dialing a Caller ID Record.....	35	Reset All Programming.....	49
Storing a Caller ID Record.....	35	CARE AND MAINTENANCE.....	50
The Caller ID for Call Waiting Feature.....	36	RADIO FREQUENCY INTERFERENCE.....	50
MESSAGE WAITING AND NEW CID INDICATION.....	37	PROBLEMS YOU CAN SOLVE.....	50
PROGRAMMING THE STATION.....	38	LIMITED WARRANTY.....	52
Getting Started.....	38	WALL MOUNT TEMPLATE.....	53
Language Programming.....	39		

## FCC INFORMATION

This equipment complies with Part 68 and Part 15 of FCC rules. On the base of this equipment is a label that contains, along with other information, the FCC Registration Number and the Ringer Equivalence Number (REN) for this equipment. If requested, this information must be given to the Telephone Company.

The REN is useful to determine the quantity of devices that you may connect to your telephone line and still have all of those devices ring when your telephone number is called. In most but not all areas, the sum of the REN's of all devices connected to one line should not exceed five (5.0). To be certain of the number of devices you may connect to your line, as determined by the REN, you should contact your local telephone company to determine the maximum REN for your calling area.

If your equipment causes harm to the telephone network, the telephone company may discontinue your service temporarily. If possible, they will notify you in advance. But if advance notice isn't practical, you will be notified as soon as possible. You will be informed of your right to file a complaint with the FCC. Your telephone company may make changes in its facilities, equipment, operations or procedures that could affect the proper functioning of your equipment. If they do, you will be informed in advance to give you an opportunity to maintain uninterrupted telephone service.

This equipment may not be used on a coin service line provided by the Telephone Company. Connection to party lines is subject to state tariffs.

# Important Safety Instructions

Some of the following information may not apply to your particular product; however, when using telephone equipment, basic safety precautions should always be followed to reduce the risk of fire, electric shock and injury to persons, including the following:

1. Read and understand all instructions.
2. Follow all warnings and instructions marked on the product.
3. Unplug this product from the wall outlet before cleaning. Do not use liquid cleaners or aerosol cleaners. Use a damp cloth for cleaning.
4. Do not use this product near water, for example, near a bath tub, wash bowl, kitchen sink or laundry tub, in a wet basement or near a swimming pool.
5. Slots and openings in the cabinet back or bottom are provided for ventilation, to protect it from over

heating. These openings must not be blocked or covered. The openings should never be blocked by placing the product on the bed, sofa, rug, or other similar surface. This product should not be placed in a built-in installation unless proper ventilation is provided.

6. Use only the power cord and batteries indicated in this manual. Do not dispose of batteries in a fire. They may explode. Check with local codes for possible special disposal instructions.
7. Do not allow anything to rest on the power cord. Do not locate this product where the cord will be abused by persons walking on it.
8. Do not overload wall outlets and extension cords as this can result in the risk of fire or electrical shock.
9. Never push objects of any kind into the product through cabinet slots as they may touch dangerous voltage points or short out

parts that could result in a risk of fire or electric shock. Never spill liquid of any kind on the product.

10. To reduce the risk of electrical shock, do not disassemble this product, but take it to a qualified serviceman when service or repair work is required. Opening or removing covers may expose you to dangerous voltages or other risks. Incorrect reassembly can cause electric shock when the appliance is subsequently used.
11. Do not expose the telephone to extreme temperatures such as found near a hot radiator or stove, or in a car parked in the summer sun.
12. Do not place lighted candles, cigarettes, cigars, etc., on the telephone.

13. Never touch uninsulated telephone wires or terminals unless the telephone line has been disconnected at the network interface.
14. Never install or modify telephone wiring during a lightning storm. Avoid using a telephone (other than a cordless type) during an electrical storm. There may be a remote risk of electrical shock from lightning.
15. Never install telephone jacks in wet locations unless the jack is specifically designed for wet locations.
16. Use caution when installing or modifying telephone lines.
17. Do not use the phone to report a gas leak in the vicinity of the leak.
18. Unplug this product from the wall outlet and refer servicing to qualified service personnel under the following conditions.
  - A. When the power supply cord or plug is damaged or frayed.
  - B. If the product has been exposed to rain or water.
  - C. If the product does not operate normally by following the operating instructions.
  - D. If the product has been dropped or the cabinet has been damaged.
  - E. If the product exhibits a distinct change in performance.

### **SAVE THESE INSTRUCTIONS**

## The NSQ412 System Features

**CONGRATULATIONS!** You have acquired a 4-line, fully featured Caller ID telephone designed to meet the many needs of a progressive small office/home office. Telephone wiring can link up to 12 stations. Features include:

- large, illuminated 16-character by 4-line Liquid Crystal Display
- non-square operation for lines 2, 3 and 4
- programmable line groups (up to 15) including Private Line availability
- intercom calling, intercom paging and all-station paging
- multi-language format (English/Spanish)
- eight speed dial locations that each hold up to 24-digits. The speed dial locations can be programmed for

special network feature codes such as Call Forward and Auto Call Return

- redial and (Auto)Redial of up to 24-digits
- 200 name/number Directory including 50 Public locations (shared between each station) and 150 Private locations
- non-volatile EE-prom memory saves data indefinitely during a power failure
- call timer
- battery back-up for operation during a power failure. The 9V battery must be installed for basic operation when AC power is lost.
- speakerphone
- headset ready
- 3-way conference
- flash key with programmable length

- programmable distinctive ringing for each line
- auto-line, ringing line and prime line preference
- automatic line privacy
- real-time clock with AM/PM format
- call hold and transfer
- message waiting indication
- programmable delayed ring
- programmable Home and Local area codes for 7-digit, 10-digit and 11-digit dialing
- Caller ID Call Waiting Caller ID with 200 locations
- line and station status on all phones sharing lines

## The Box Contents

Carefully remove the telephone from its shipping carton. If there are any visible indications of damage to the unit or accessories, do not attempt to operate it. Call International Resources at (888) 772-5200 for help.

Check the carton carefully for the following items. You should have:



Keep the box and all packing materials for storing or shipping the NSQ412. Keep all printed literature and proof of purchase for reference. On the base unit bottom, there is a serial number. Please write it below for future reference:

NSQ 412 SERIAL NUMBER: \_\_\_\_\_

**NOTE:** The Time/Date and Station Number should be programmed before using each station.



## Key and Indicator Descriptions

The following drawings provide identification and brief descriptions of the base controls, keys and indicators.

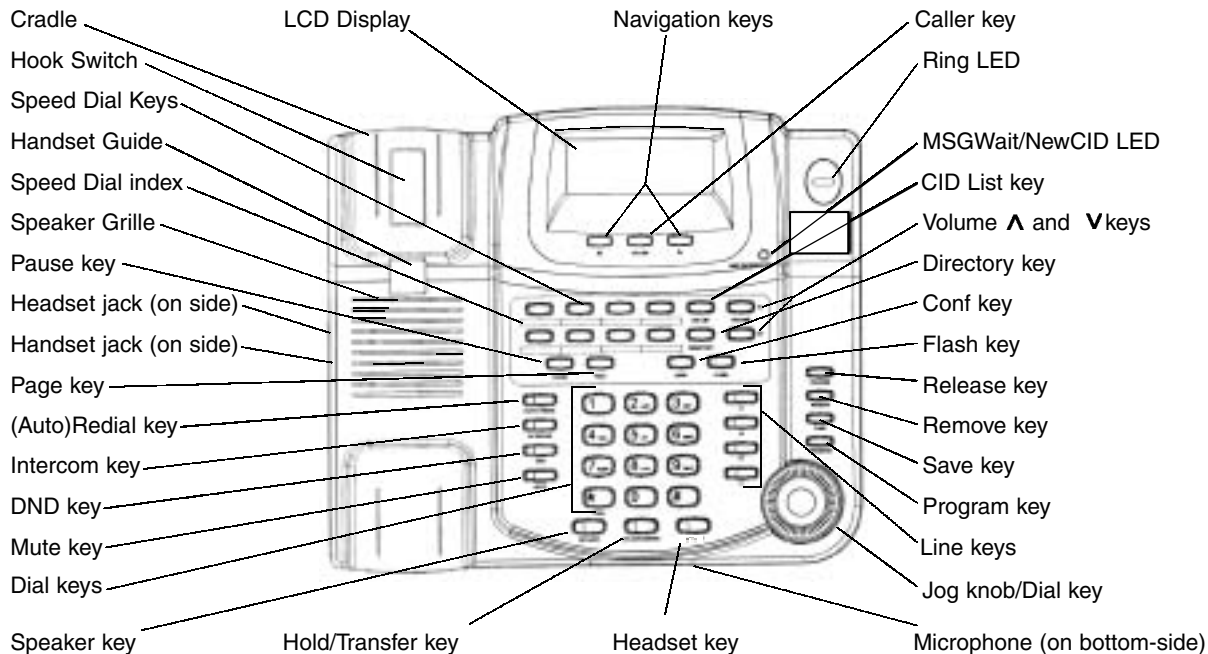

**Cradle:** The place to put the handset when not in use.

**Hook Switch:** The switch that connects a call when released and disconnects a call when depressed.

**Handset Guide:** This sits flush for desk use and provides a hook to hold the handset when wall mounted.

**Speaker Grille:** The location of the Speakerphone speaker.

**[SPD#] keys:** Eight keys used for storing often-used telephone numbers, Voicemail Navigation codes, and Network Feature codes.

**Speed Dial Index:** Removable index for identifying the contents of the Speed Dial keys.

**[PAUSE] key:** Used for inserting a 3-second pause between digits when dialing.

**[PAGE] key:** Initiates and answers page.

**Headset Jack (on side):** Used for con-

necting an optional external headset.

**Handset Jack (on side):** Used to connect the coiled handset cord.

**[(AUTO)REDIAL] key:** Redials the last number or starts the Auto-Redial process. The integrated LED will indicate the Auto-Redial status.

**[INTERCOM] key:** Initiates and answers the Intercom. The integrated LED will indicate the status.

**[DND] key:** Activates and disables the Do Not Disturb operation. The integrated LED will indicate the status.

**[MUTE] key:** Activates and disables the microphone for a private conversation in your room without affecting the incoming audio. The integrated LED will indicate the status.

**[DIAL] keys:** The 12-keys for dialing and programming telephone numbers.  
NOTE: the [\*/TONE] key temporarily changes the dial operation to Tone if the dialing is set to Pulse.

**[SPEAKER] key:** Activates and disables the Speakerphone operation. The integrated LED will indicate the status.

**LCD Display:** The Liquid Crystal Display shows the operational status of the station.

**[HOLD/TRANSFER] key:** Activates and disables the Hold and Transfer features. The integrated LED will indicate the status.

**Navigation [<] and [>] keys:** Used to move the cursor when entering data. Also enters and exits levels when programming.

**[HEADSET] key:** Activates and disables the optional headset. The integrated LED will indicate the headset status.

**[CALLER] key:** Used to show other screens when more than one line is ringing.

**Ring LED:** Flashes when the station is ringing.

**MSG Wait/New CID LED:** Will indicate when a voicemail message has been left in your telephone company voicemail box and when new Caller ID records have been received.

**[CID LIST] key:** Used to access the Caller ID records.

**[DIRECTORY] key:** Used to access the Private and Public Directories.

**[CONF] key:** Used to conference two calls with the station.

**Volume [▲] and [▼] keys:** Use to adjust the Handset, Speakerphone, Headset and Ringer volume.

**[FLASH] key:** Provides a momentary break in the telephone line for accessing special features like Call Waiting.

**[RELEASE] key:** Used to quit the current function or display.

**[REMOVE] key:** Used to delete the programming or Caller ID in the display.

**[SAVE] key:** Used to store the displayed

programming.

**[PROGRAM] key:** Used to start the programming operation.

**[LINE 1], [LINE 2], [LINE 3] and [LINE 4] keys:** Used to manually select a line. The integrated LEDs will indicate each line status.

**[JOG] knob and [DIAL] key:** Rotating the [JOG] knob changes the displayed items. Pressing the [DIAL] button will dial the telephone number shown in the display.

**Microphone (on bottom-side):** Used for the speakerphone outgoing audio.

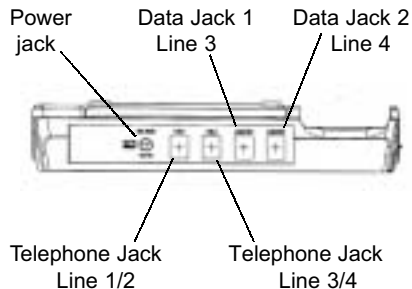

**Line Jacks:** Jack L1/L2 is used for telephone lines 1 and 2. Jack L3/L4 is used for telephone lines 3 and 4. Data jacks 1 and 2 are used to connect a fax, modem or other device through the NSQ412 to the telephone line.

**Power Jack:** The jack for connecting the a. c. power adapter to the station.

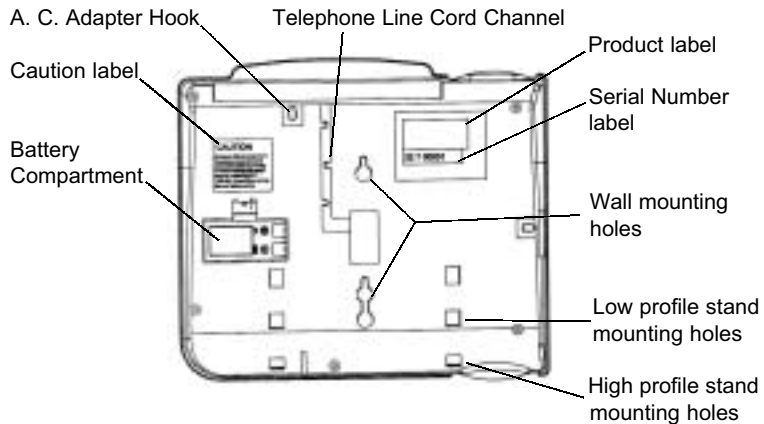

**A. C. Adapter Hook:** Secures the A. C. Adapter wire, preventing accidental removal.

**Battery Compartment:** Location for the 9-V battery that allows limited operation during a power failure.

**Telephone Line Cord Channel:**

A groove for routing the telephone line cord during wall mounting.

**Caution label:** Important warning information.

**Product Label:** Identifies the unit and provides information.

**Serial Number Label:** Identifies when the product was manufactured.

**Wall Mounting Holes:** Standard holes designed to fit Western Electric and Verizon AE style wall jacks.

**Low Profile Stand Mounting holes:** Used with the stand for a low profile desk installation.

**High Profile Stand Mounting Holes:** Used with the stand for a high profile desk installation.

## Installation Preparation

Installing the NSQ412 is easy as long as you do a little planning before starting. Locate each station within ten feet of an a. c. power outlet and seven feet of the telephone jacks. The maximum amount of telephone wire that can be between two stations is 600 feet.

**IMPORTANT:** Taking full advantage of the system features requires that the telephone number connected to Line 1 be the same on all stations. If this is not done, the Privacy, Intercom, Page and Transfer will not work properly. In addition, it is strongly recommended that no other devices operate on Line 1 besides the NSQ412 stations. Any interference on it can degrade the system performance. The system can be used on a DLS line if either: 1) Line 1 is not the DSL line; or 2) Line 1 wiring connected to all stations is behind the DSL filter port.

There are many different wiring configurations that a telephone jack can have. The station will support both a home run (the phone line is run from a connecting block to each station) and daisy chain (the phone line is run from one phone to the next) wiring configuration. Many older homes and businesses have just one telephone line on each jack. Newer homes and businesses typically have two or three lines per jack. You must identify how your telephone jacks are wired before connecting them to the NSQ412. If you cannot determine this, call your telephone service provider for assistance.

It is a good idea to document the phone wiring for each NSQ412 location. This can be done using the following work sheet. Record the telephone number for each line and the jack it is found on for each station.

Station Number	Line 1/Jack	Line 2/Jack	Line 3/Jack	Line 4/Jack
11				
12				
13				
14				
15				
16				
17				
18				
19				
20				
21				
22				

For example, stations 11, 12 and 13 will have telephone numbers 555-1111 on Line 1, and 555-2222 on Line 2. Station 11 and 12 will have 555-3333 on Line 3. Station 11 will have 555-4444 on line 4. Stations 12 and 13 will have 555-5555 on line 4. Station 13 will have 555-4444 on line 3. At station 11's location, each telephone number has a separate jack. At station 12's location, lines 1 and 2 share one jack and lines 3 and 4 share another jack. At station 13's location, lines 1 and 2 share one jack while line 3 and line 4 each have separate jacks. The work sheet would be filled out as follows:

Station Number	Line 1/Jack	Line 2/Jack	Line 3/Jack	Line 4/Jack
11	555-1111/jack 1	555-2222/jack 2	555-3333/jack 3	555-4444/jack 4
12	555-1111/jack 1	555-2222/jack 1	555-3333/jack 2	555-5555/jack 2
13	555-1111/jack 1	555-2222/jack 1	555-4444/jack 2	555-5555/jack 3

Each station has four telephone line jacks located on the base cabinet's side. The first jack is for telephone lines 1 and 2. The second jack is for telephone lines 3 and 4. Jack 3 and jack 4 are Data jacks used for connecting a modem or fax machine to the telephone network through the NSQ412.

## CAUTION!

1. Never install telephone jacks during a lightning storm.
2. Never install telephone jacks in wet locations unless the jack is specifically designed for wet locations.
3. Never touch uninsulated telephone wires or terminals unless the telephone line has been disconnected at the network interface.
4. Use caution when installing or modifying telephone lines.
5. Always disconnect all telephone lines from the wall outlet before servicing or disassembling this equipment.
6. Danger of explosion if battery is incorrectly replaced.

## Installing the Telephone on a Desk or Table

Once the telephone jack-wiring configuration is determined, proceed with

installing the telephone. **NOTE:** Do not connect the a. c. power adapter until instructed to do so.

The following instructions show how to connect four telephone lines to the NSQ412. As few as one line can be connected.

1. Carefully remove all of the telephone components from their packing.
2. Turn the unit over and remove the screw from the battery compartment using a #2 Philips screwdriver. Open the battery door by pressing the tab. Install a 9V alkaline transistor radio battery. Be sure to install the battery polarity correctly by observing the drawing on the inside of the compartment. Replace the battery door and the screw.
3. Insert one end of the coiled handset cord into the handset's jack and the other end into the base handset jack.

Low Profile

High Profile

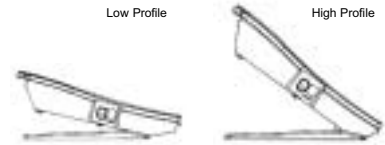

4. Attach the stand to either the low profile or high profile mounting holes. It will snap into place.
5. If telephone lines 1 and 2 are on one jack and telephone lines 3 and 4 are on another jack, see the following connection drawing. Otherwise, go to step 6.

Connect telephone jack 1 to the NSQ412 L1/L2 jack using one of the 4-conductor telephone line cords supplied with the telephone. Connect telephone jack 2 to the NSQ412 L3/L4 jack using the other 4-conductor telephone line cord supplied with the telephone.

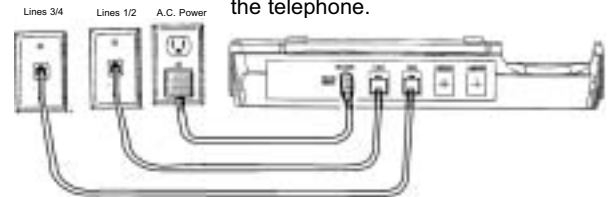

6. If telephone lines 1, 2, 3, and 4 are all on separate jacks, two adapters and extra telephone line cords are necessary (not included with the telephone). See the following connection drawing.

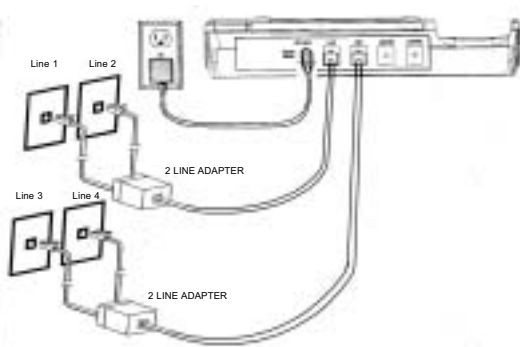

The adapters will convert two separate telephone jacks into a single one. Connect telephone line 1 into the adapter. Connect telephone line 2 into the adapter. Connect the adapter output jack into the NSQ412 L1/L2 jack using one of the 4-conductor telephone line cords supplied with the telephone. Repeat this process using the second adapter for telephone

lines 3 and 4. Connect the output of the second adapter jack to the NSQ412 L3/L4 jack using the other telephone line cord supplied with the telephone.

If your telephone wiring does not match either of the examples above or one of their variations, you may need to call your telephone service provider for assistance. They can install the necessary jacks wired in the correct configuration.

7. Once the telephone line(s) are connected to the station, plug the a. c. adapter into the NSQ412 power jack. Route the cord through the A. C. Adapter Hook, then connect the adapter to an electrical outlet. The station will initialize for about 7 seconds, then be ready for use.

The telephone has the programming set to the most common selections. **See the Quick Reference Card to begin using it immediately.** Refer to the

Programming section of this manual for customizing the station's operation and the Feature Sections for advanced operation and use.

## Installing the Telephone on a Wall

The station may be installed onto the studs of a telephone wall jack or onto 2 screws that are securely fastened to the wall. Once the telephone wall jack-wiring configuration is determined, proceed with the installation. **NOTE:** Do not connect the a. c. adapter until instructed to do so.

The following instructions show how to connect four telephone lines to the NSQ412. As few as one line can be connected.

1. Carefully remove all of the telephone components from their packing
2. Turn the unit over and remove the screw from the battery compartment using a #2 Philips screwdriver. Open the battery door by pressing the tab.



Install a 9V alkaline transistor radio battery. Be sure to install the battery polarity correctly by observing the drawing on the inside of the compartment. Replace the battery door and the screw.

3. Plug one end of the coiled handset cord into the handset's jack and the other end into the base handset jack.
4. For wall mounting, the handset must be retained securely in the cradle. The handset guide must be changed from the desk position to the wall position. To do this, pull the handset guide out and rotate it 180. It will now protrude slightly, providing a tab for the handset to rest on.



5. Connect the a. c. power adapter to the power jack on the NSQ412. Do not connect the adapter to the electrical outlet at this time. Route the adapter cord through the A. C. Adapter Hook on the station's back.

If you are installing the NSQ412 to screws, skip down to step 12.

6. If you install the NSQ412 to the mounting studs of a telephone wall jack, lines 1 and 2 must be terminated to it. Lines 3 and 4 (if used) must be terminated to a different jack.
7. Connect the short 4-conductor telephone line cord supplied with the unit to the L1/L2 jack. Route the cord through the telephone line cord channel on the station's back.
8. Hold the station close to the telephone wall jack and plug the short line cord into it. Align the wall jack studs with the wall mounting holes on the NSQ412's back.

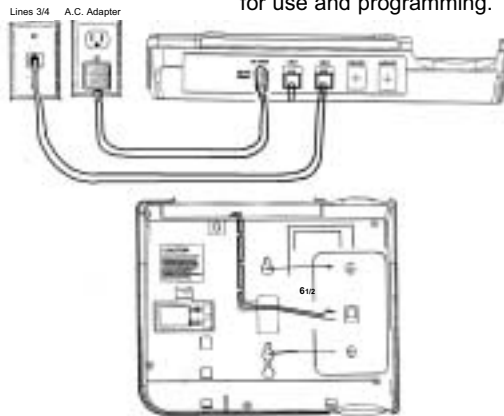

9. Push the NSQ412 onto the studs and firmly pull downward (toward the floor), locking the station onto the wall jack.
10. Connect the other telephone jack with lines 3 and 4 to the NSQ412 jack L3/L4 using one long 4-conductor telephone line cord supplied with the telephone.
11. Connect the a. c. adapter to an electrical outlet. The station will initialize for about 7 seconds, then be ready for use and programming.

12. Follow these steps if the station will be installed on screws securely fastened to the wall. If telephone lines 1 and 2 are on one jack and telephone lines 3 and 4 on another jack see the following connection drawing. Otherwise go to step 13.

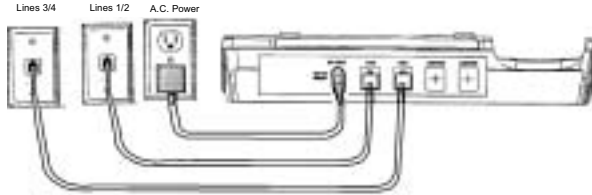

Connect telephone jack 1 to the NSQ412 L1/L2 jack using one of the 4-conductor telephone line cords supplied with the telephone. Connect telephone jack 2 to the NSQ412 L3/L4 jack using the other 4-conductor telephone line cord supplied with the telephone.

13. If telephone lines 1, 2, 3 and 4 are all on separate jacks, two adapters and extra telephone line cords are necessary (not included with the telephone). See the following connection drawing.

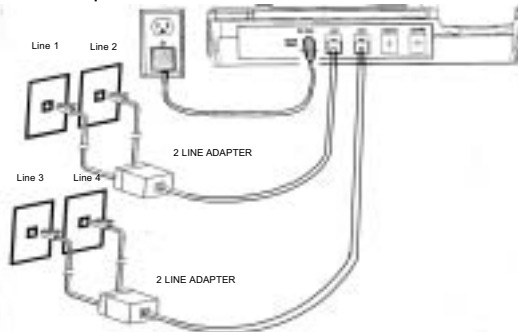

The adapters will convert two separate telephone jacks into a single one. Connect telephone line 1 into the adapter. Connect telephone line 2 into the adapter. Connect the adapter output jack into the NSQ412 L1/L2 jack using one of the 4-conductor telephone line cords supplied with the telephone. Repeat this process using the second adapter for telephone lines 3 and 4. Connect the output of the second adapter jack

to the NSQ412 L3/L4 jack using the other telephone line cord supplied with the telephone.

14. Using the supplied screw template, install the screws into the wall. Be sure to use anchors to ensure a secure mounting. Leave the screws protruding from the wall 3/16".

15. Hold the station close to the screws and align them with the wall mounting holes on the NSQ412's back. Push the station onto the screws and firmly pull downward (towards the floor), locking the station to the wall.

16. Connect the a. c. adapter to an electrical outlet. The station will initialize for about 7 seconds, then be ready for use.

The telephone has the programming set to the most common selections. **See the Quick Reference Card to begin using it immediately.** Refer to the Programming section of this manual for customizing the station's operation and the Feature Sections for advanced operation and use.

## Basic Features

### LED Illumination

The NSQ412 LEDs will indicate the station's status. The following chart identifies the different patterns that can occur during use.

LED Illumination	
LED State	Specification
dark	solid dark
lit	solid lit
fast flash	0.125S off, 0.125S on, repeatedly
slow flash	0.5S off, 0.5S on, repeatedly
wink 1	0.250S off, 1.750S on, repeatedly
wink 2	0.250S off, 0.250S on 0.250S off, 1.250S on, repeatedly
wink 3	0.250S off, 0.250S on, 0.250S off, 0.250S on, 0.250S off, 0.750S on, repeatedly

The Line LEDs will indicate status according to the following chart:

CO Line LED Operation		
Status	Using station	Other Stations
Idle	Dark	Dark
In Use	Wink 1	Solid
On Hold	Wink 2	Wink 3
Ringing	Slow	Slow
Transfer	Fast	Wink 3

The station's other LEDs will indicate status according to the following chart:

Other LED Operation	
Intercom	dark: Intercom link idle lit: Intercom link used by other station fast: Station is receiving an Intercom call wink 1: Station is using intercom
Hold	dark: No CO Line is on hold Wink 2: A CO Line is on hold
Mute	dark: The station is not muted lit: The station is muted
Speaker	dark: The handsfree is off lit: The handsfree is on
Headset	dark: The headset is not in use lit: The headset is in use
DND	dark: The DND is off lit: The DND is on
Auto Redial	dark: The auto redial function is not in use slow: Station is in the on-hook waiting cycle fast: Station is in the off-hook dialing cycle
MSG Wait/New CID	dark: No Message Waiting and no New CID records fast: Message Waiting (with/without New CID) lit: New CID record(s) only (no Message Waiting)
Oval LED	dark: No ringing fast: With incoming CO, Intercom or Transfer ring

## Ringer Status

The station's ringer will indicate the status as shown in the following chart

Ring Cadence	
CO ring	In sync with CO ring signal (it will choose one pattern if more than 1 CO Line is ringing at the same time)
Intercom ring	0.250S on, 0.250S off, 0.250S on, 1.250S off, repeatedly
Transfer ring	1S on, 1S off, repeatedly
ID Error ring	Continuously
Single Beep	0.250S on
Double Beep	0.250S on, 0.250S off, 0.250S on, 0.250S off

## Intercom Tone Status

The station's intercom tones are shown below:

Intercom Tones	
dial tone	continuous
busy tone	0.5S on, 0.5S off, repeatedly
DND tone	0.25S on, 0.25S off, repeatedly
ring back tone	1S on, 1S off, repeatedly

## Station Initialization

The telephone will perform initialization during the first seven seconds that a. c. power is applied. The LCD will display:

```
initializing..
```

During initialization, the telephone will perform self-diagnostics and determine if other system telephones are connected. It will indicate if its station number is already used by another station by continuous ringing. If the telephone has the factory default settings, the LCD will display:

```
01/01 01:00A  
EXT 11 PowerFail  
press PROG to  
setup your phone
```

"01/01 01:00A"

The default time.

"EXT 11"

The default station number.

"PowerFail"

The phone was just turned on. (This prompt will cancel if any key is pressed or the phone goes off-hook.)

"press PROG to  
setup your phone"

This is displayed if the phone is with factory default settings when the a. c. adapter is plugged in. (This prompt will be canceled if the [PROGRAM] is pressed.)

If the phone already has some programmed settings, the LCD may display like:

```
1 2 / 2 6      1 2 : 0 8 P
E X T  1 1   P o w e r f a i l
C I D : 1 0 0 / 1 9 8
```

The "PowerFail" text will be canceled if any keys are pressed. **NOTE:** Check and reset the Time and Date as necessary when the "PowerFail" text is displayed.

The idle LCD display shall be:

```
1 2 / 2 6      1 2 : 0 8 P
E X T  1 1
C I D : 1 0 0 / 1 9 8
```

## Answering a Call

To answer an incoming outside call with the handset, press the flashing [CO Line] key and pick up the handset. An alternate method is to lift the handset and the last incoming call is automatically picked up. **NOTE:** When multiple lines are ringing simultaneously, picking up the handset will cause the telephone to answer

the CO Line which has the Caller ID info in the display.

To answer an incoming outside call handsfree, press the [SPEAKER] key. **NOTE:** When multiple lines are ringing simultaneously, pressing the [SPEAKER] key will cause the telephone to answer the CO Line which has the Caller ID info in the display. An alternate method is to press the flashing [CO Line] key, provided the unit is not operating in the Headset mode.

To answer an incoming outside call using the headset, press the [HEADSET] key. **NOTE:** When multiple lines are ringing simultaneously, pressing the [HEADSET] key will cause the telephone to answer the CO Line which has the Caller ID info in the display. An alternate method is to press the flashing [CO Line] key, provided the unit is not operating in the Handsfree mode.

## Making a Call

To make an outgoing call with the handset, lift the handset. An idle CO Line will automatically be connected. The CO Line

selected will depend upon the Line Preference set in programming mode and if there are lines in use.

Dial the phone number and the LCD displays the digits one by one. The timer begins to count. For example, dial 1,2,3,4,5,6,7 and the LCD will display:

```
1 2 3 4 5 6 7 □
0 0 : 0 1
C I D : 1 0 0 / 1 9 8
```

**NOTE:** If you dial more than 15-digits, all the digits will be shifted to the left side. For example, dial 1,2,3,4,5,6,7,8,9,0,1,2,3,4,5 and the LCD will display:

```
1 2 3 4 5 6 7 8 9 0 1 2 3 4 5 □
0 0 : 0 3
C I D : 1 0 0 / 1 9 8
```

Then dial 6, the LCD will display:

```
. . 4 5 6 7 8 9 0 1 2 3 4 5 6 □
0 0 : 0 4
C I D : 1 0 0 / 1 9 8
```

To make an outgoing call handsfree, press the [SPEAKER] key. An idle CO Line will automatically be connected. The CO Line selected will depend upon the Line Preference set in programming mode and if there are lines in use. Dial the phone number and the LCD displays the digits one by one. The timer begins to count. The LCD will display the same as when making an outgoing call with the handset (see previous examples).

To make an outgoing call using the headset, press the [HEADSET] key. An idle CO Line will automatically be connected. The CO Line selected will depend upon the Line Preference set in programming mode and if there are lines in use.

**NOTE:** Pressing the [HEADSET] key without the headset plugged in will result in a double beep warning (the headset mode will not activate). Dial the phone number and the LCD displays the digits one by one. The timer begins to count. The LCD will display the same as when making an outgoing call with the handset (see previous examples).

**NOTE:** The unit will always dial Tone numbers unless the dial mode is

changed to Pulse in programming.

### **Switching Between Handset, Handsfree and Headset**

The telephone will allow switching between the handset, handsfree and headset modes. To switch from the handset to handsfree, press the [SPEAKER] key. The Speaker LED will light. The handset may be placed in the cradle, but does not have to be.

To switch from handset to headset, press the [HEADSET] key. The Headset LED will light. The handset may be placed in the cradle, but does not have to be.

To switch back to handset when it is in the cradle, lift the handset. The handsfree or headset will be disabled. To switch back to the handset when it is out of the cradle, press the [SPEAKER] key (if in handsfree mode) or the [HEADSET] key (if in headset mode). The handsfree or headset will disable.

**NOTE:** When the phone is on-hook and idle, pressing a [CO Line] key will activate the previous talking mode (hands-

free or headset). The default is handsfree mode.

### **Call Timer Operation**

The timer will automatically start to count when a CO Line is picked up. It will stop counting automatically when the CO Line is hung up. The LCD will continue to display the time for approximately 10-seconds afterwards. The LCD will display the elapsed time in minutes and seconds for the first hour (up to 59 minutes and 59 seconds), then begin counting again at 00:00. The timer will start over whenever the CO Line status is changed (such as placed on hold, or flash activated, etc.).

## Hold Operation

To place a call on hold, press the [HOLD/TRANSFER] key. The hold is automatically activated if the telephone is on a CO Line and either the [INTER-COM] or [PAGE] keys are pressed.

**NOTE:** If no digits have been dialed on an outgoing call, the CO Line will be dropped automatically. The LCD will display the text "Transfer \*" for approximately 10-seconds then return to default if no station number is entered (see Transferring a Call to Another Station below).

A double beep hold reminder tone is heard approximately every 30-seconds at the holding station (unless the hold reminder is disabled in programming mode). The hold is abandoned after 20 minutes if no telephone picks up the CO Line and the holding telephone has no other activity. The hold reminder and hold abandon timer are automatically activated with the hold feature.

The hold is released by any system telephone pressing the held [CO Line] key.

## Transferring a Call to Another Station

To transfer a CO Line to another system telephone, press the [HOLD/TRANSFER] key. The LCD will display:

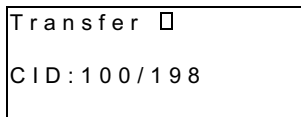

Dial the station number to receive the call. The CO Line will be transferred automatically. The transferee will hear the CO transfer ring. The transferor will activate the hold reminder (unless the hold reminder is disabled in programming mode). All system telephones can pick up the transferred CO Line. **NOTE:** The transfer feature will automatically cancel if a station number is not entered within approximately 10-seconds of pressing the [HOLD/TRANSFER] key.

## Release Operation

Pressing the [RELEASE] key will end the function that is active. If off-hook, the unit will return to on-hook and the display will return to idle. If programming, the unit will exit programming mode without mak-

ing any changes and the display will return to idle.

## Redial and (Auto)Redial

To redial the last number dialed, up to 24-digits; obtain an idle CO Line with the handset, handsfree or headset. Press the [(AUTO)REDIAL] key. The telephone will dial the number automatically. The LCD will display the same as when making an outgoing call with the handset.

The phone can automatically redial a number up to 10 times. With the telephone on-hook and in an idle state, press the [(AUTO)REDIAL] key twice within 3-seconds. The telephone will automatically pick up an idle CO Line and dial the last dialed number. The telephone will remain off-hook for 30-seconds and busy tone may be audible. If nothing is done, the telephone then goes on-hook for 30-seconds. It will continue to cycle through this process for ten times unless the user stops it.

An alternate method to start the (Auto)Redial function is to press an idle [CO Line] key followed by pressing the [(AUTO)REDIAL] key twice within 3-seconds.

Pick up the handset, or press [SPEAKER] or [HEADSET] keys to stop the (Auto)Redial function and talk with the called party. **NOTE:** Pressing any other key except the Volume [▲] and [▼] will cancel the (Auto)Redial operation.

## Prime Line Preference

The telephone's Prime Line Preference determines the priority that idle CO Lines are picked up when going off-hook from the idle state. The line preference is selected in programming mode. Line 1 is selected by default. If the preferred line is in use by another station, the next higher idle CO Line is picked up.

## CO Line Privacy

The telephone has CO Line Privacy. This feature prevents another station from picking up a CO Line that is in use. This feature automatically activates when a

CO Line is used.

CO Line privacy can be disabled by pressing the [CO Line] key used at the original station. A beep is heard when this is done. The privacy can be recovered by again pressing the in-use [CO Line] key. A double beep is heard when this is done.

**NOTE:** A non-system telephone does not have line privacy on any system station.

## Intercom Operation

To make an intercom call with the handset, press the [INTERCOM] key and pick up the handset. The LCD will display:

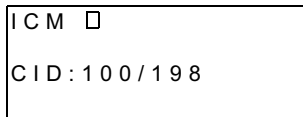

```
ICM 12
CID : 100 / 198
```

Dial the desired station number. For example, station 12 calls station 15. The LCD for station 12 will display:

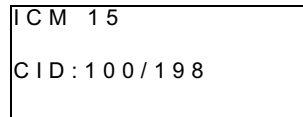

```
ICM 15
CID : 100 / 198
```

The LCD for station 15 will display:

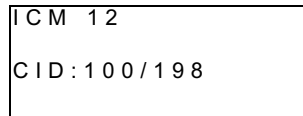

```
ICM 12
CID : 100 / 198
```

The display of the stations will return to normal after the intercom call is finished.

If the called station is idle, the calling station will get ring back tone. If the called station is busy, the calling station will get busy tone. If the called station has DND active, the calling station will get the DND tone. **NOTE:** If the called station is not entered within approximately 10-seconds after pressing the [INTERCOM] key, the intercom trunk will be automatically released.

Any station can pick up an intercom call directed to another station. To do so, press the [INTERCOM] key.



To make an intercom call in the hands-free mode, the station must be idle. Press the [INTERCOM] key. If the headset activates, press the [SPEAKER] key. Dial the desired station number. The LCD will display and the station will function the same as when making an intercom call with the handset (see previous examples).

To make an intercom call in the headset mode, the station must be idle. Press the [INTERCOM] key. If the handsfree mode activates, press the [HEADSET] key. Dial the desired station number. The LCD will display and the station will function the same as when making an intercom call with the handset (see previous examples).

To answer an intercom call in the handset mode, lift the handset. To answer an intercom call in the handsfree mode, press the [INTERCOM] key (if the headset activates, press the [SPEAKER] key). To answer an intercom call in the headset mode, press the [INTERCOM] key (if the handsfree mode activates, press the [HEADSET] key).

## Paging Operation

To page a specific station, press the [PAGE] key. The LCD will display:

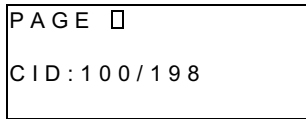

```
PAGE □  
CID: 100/198
```

Dial the desired station number. For example, station 12 pages station 15. Station 12's LCD will display:

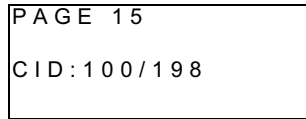

```
PAGE 15  
CID: 100/198
```

If the page call succeeds, station 15's LCD will display:

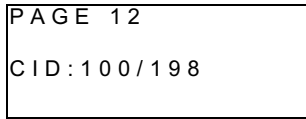

```
PAGE 12  
CID: 100/198
```

A station that receives a page will emit a single beep. It will then enter handsfree mode and the paging station's audio will be heard. If the Auto-Mute is enabled in programming mode at the paged station, the Mute LED will be on and the paging

party will not hear sounds in the room. If the Mute LED is not on, the paging party can hear sounds in the room. To speak with the paging station by handsfree when Auto-Mute is enabled, press the [MUTE] key. To speak with the paging station by handset, pick-up the handset. To speak with the paging station by headset, press the [HEADSET] key.

## Interchanging the Intercom and Page

An intercom call can be changed to a page call while in process. Pressing the [PAGE] key does this.

A single station page can be changed to an intercom call. Pressing the [INTERCOM] key does this.

## Paging All Stations

A station can page all the stations simultaneously. Press the [PAGE] key followed by the [\*] key. The paging station's LCD will display:

```
PAGE ALL
CID: 100/198
```

The paged stations will emit a single beep. The LCD of all stations that accept the page will display:

```
PAGE ALL BY 12
CID: 100/198
```

The message can then be announced to all idle stations. Any station can answer an all-station page. Pressing the [PAGE] key at a paged station does this.

## Mute Operation

Press the [MUTE] key to temporarily remove the outgoing audio to the calling party. Pressing the [MUTE] key again deactivates the feature. The integrated

LED will illuminate when the mute feature is active. The mute status remains the same when switching between the handset, handsfree and headset.

## Pause Operation

Pressing the [PAUSE] key will automatically insert a 3-second waiting period in the dialing sequence. Multiple pauses can be used for a longer waiting time. A pause may be stored in Speed Dial (it will count as one digit in memory for each pause used). The audio can be heard during the pause, so the call progress can be monitored.

## Flash Key Operation

Pressing the [FLASH] key will cause the telephone to open the telephone line for a programmed amount of time. The flash time can be set in programming from 100mS to 1200mS, in 100mS increments. The flash may be stored in the Directory and Speed Dial locations (it will count as one digit in memory for each one used). It will not be stored in the Last Number Redial when manually dialed. It will be stored in the Last Number Redial

when dialed from the Directory or Speed Dial.

The flash key should be used to access telephone special features such as call waiting and 3 way calling.

## Temporary Tone Dialing

The telephone dialing can be temporarily changed to tone when the default dialing is set to pulse in programming mode. Press the [\*/TONE] key when tone service is needed. A 1.5-second pause will be inserted between the last pulse digit and the first tone digit. The tone dialing will continue until the telephone is hung up or the [FLASH] key is pressed (then the dial mode reverts back to pulse).

## Conference Operation

The Conference allows a station to establish a 3-party conversation. Conference may occur between two stations and a single CO Line or between one station and two CO Lines. To have a conference call, put the CO Line on hold. Make a second call either by intercom or a CO Line. Press the [CONF] key after the second person answers. All three people will be connected together. End the conference call by hanging up or pressing the [RELEASE] key (the phone goes to idle).

## Do Not Disturb Operation

The telephone has Do Not Disturb (DND). A station with DND enabled will not ring (it will display Caller ID info and the LEDs will function). Press the [DND] key to activate. The DND LED will illuminate and the LCD will display:

```
1 2 / 2 6           1 2 : 0 8 P
D N D   1 2
C I D : 1 0 0 / 1 9 8
```

Press the [DND] key again to cancel the

function. The LCD display will return to the idle state.

## The Volume Key Operation

Pressing the Volume [▲] and [▼] keys while the telephone is on-hook will adjust the ringer volume. There are 4-levels. A warning beep will sound when the loudness is at minimum or maximum. The default loudness is set to level-3. The ringer volume is the same for all lines (it cannot be set differently for any line). The ringer for each line can be disabled in programming mode.

Pressing the Volume [▲] and [▼] keys while off-hook in handsfree mode will set the handsfree volume. There are 8-levels. A warning beep will sound when the loudness is at minimum or maximum. The volume will remain at the user-adjusted setting after the phone goes on-hook. The default loudness is set to level-4. The handsfree volume is the same for all lines (it cannot be set differently for any line).

Pressing the Volume [▲] and [▼] keys while off-hook with the handset will set

the receiver volume. There are 4-levels. A warning beep will sound when the loudness is at the minimum or maximum. The volume will remain at the user-adjusted setting after the phone goes on-hook. The default loudness is set to level-1.

Pressing the Volume [▲] and [▼] keys while off-hook with the headset will set the headset volume. There are 4-levels. A warning beep will sound when the loudness is at the minimum or maximum. The volume will remain at the user-adjusted setting after the phone goes on-hook. The default loudness is level-1.

## Battery Low Warning

The telephone will indicate when the battery is low (or missing). The LCD will display:

```
1 2 / 2 6           1 2 : 0 8 P
E X T   1 2
C I D : 1 0 0 / 1 9 8   B A T T
```

## POWER FAILURE OPERATION

The NSQ412 will operate during a power failure as long as the 9V battery is installed and in good condition. Many of the station's advanced features are turned off when operating only on the battery. This is to prolong use. The following features will operate from only battery power:

- a. the clock
- b. basic telephone operation (incoming and outgoing calls) on all 4 CO Lines in handset and headset mode (no speakerphone)
- c. the LCD display and Line LEDs

If talking on the speakerphone and a power failure occurs, the call will remain connected. Pick up the handset to continue the conversation. A call that is on hold will be dropped.

The phone will reinitialize when the a. c. power is restored. This is normal. The station will wait until it is idle before the initialization will occur.

All other features will not operate.

**NOTE: The telephone will not operate during an electric power failure if the battery is dead or missing.**

## Line Status Indication

The telephone will detect the status for non-system devices that may be connected to the CO Lines (single line phone, fax, modem, etc.). When a non-system device goes off-hook, the station CO Line LED will illuminate. After the non-system device goes on-hook, the station CO Line LED will turn off. **NOTE:** When a non-system device goes off-hook, any one of the system telephones can pick up the call by pressing the [CO Line] key. Once a system phone picks up the call, the privacy feature is activated and no other system telephone can listen to the call.

## Disabling Unused Lines

The station can disable access to CO Line functions that are not being used at it. This is done in programming mode. The [CO Line] key and CO Line LED are disabled for any line that is programmed to Off.

## Non-Square Operation

The telephone's wiring configuration is non-square for CO Lines 2, 3 and 4. This means that Lines 2, 3 and 4 do not have to share the same telephone numbers for every station. Any station can have its own private line(s) or, the line(s) can be shared between some of the phones. Groups can be set up in programming to allow transferring, conferencing and Line Status indications to work on shared lines. By default, Line 2 belongs to Group 2, Line 3 to Group 3 and Line 4 to Group 4.

For example, if telephone number 555-3333 is used on Line 3 on stations 11 and 12 and 555-4444 is used on Line 3 on stations 13 and 14, the Line Group should be changed from 2 to 5 on stations 13 and 14. When this is done and station 11 is off-hook on Line 3, station 12 will show Line 3 is in use, but stations 13 and 14 will not. Station 11 can transfer the Line 3 call to station 12 (which is in the same group), but cannot to stations 13 and 14 (because they are in a different group).

Refer back to the worksheet prepared in the Getting Started section for help in determining which lines may need to have the Group number changed.

Remember: Line 1 must be common on all stations, but each telephone number on the remaining lines should be either Private or have the same Group number as all of the other stations that share it.

## ADVANCED FEATURE OPERATION

### Viewing the Directory

To view the Directories, press the [DIRECTORY] key. The LCD will display:

```
DIRECTORY
<>:select
  Public/Private
```

Press the NAVIGATION [<] or NAVIGATION [>] key to select the Public or Private Directory. The LCD will display:

```
Public DIR
<>:select
  Public/Private
```

or

```
Private DIR
<>:select
  Public/Private
```

If the directories are full, the LCD will display:

```
Public DIR FULL
<>:select
  Public/Private
```

or

```
Private DIR FULL
<>:select
  Public/Private
```

To exit the Directory mode, press the [RELEASE] key.

### Programming the Directory

To save information into the Directories, press the [DIRECTORY] key. The LCD will display:

```
DIRECTORY
<>:select
  Public/Private
```

Press the [SAVE] key. The unit will enter the mode to save a name. The LCD will display:

```
□(Enter name)
SAVE:save?
```

Press the [SAVE] key if no name is to be entered. Otherwise, repeatedly press the dial keypad that has the letters or symbols, until the display shows the character needed. Press the NAVIGATION [>] key to move to the next space or to add a blank space. Press the NAVIGATION [<] key to move backward (erasing a space). The following table shows what each dial key can program:

1=, - ' & . () 1	2=ABC2	3=DEF3
4=GHI4	5=JKL5	6=MNO6
7=PQRS7	8=TUV8	9=WXYZ9
* = *	0 = 0	# = #

For example, the LCD will display the name "Paul":

```
PAUL □
```

Press the [SAVE] key to store the text and begin the number storing process:

```
PAUL  
□ ( Enter number )  
SAVE : save ?
```

Use the dial keypad to enter the phone number. To enter the number from the Last Number Redial location, press the [REDIAL] key. For example, the LCD will display the number "555-1212":

```
PAUL  
5 5 5 1 2 1 2 □  
SAVE : save ?
```

While entering numbers, the [REMOVE] key can be pressed to store a special function for automatically hanging up the CO Line after dialing the number. For example, storing the network feature code "\*\*73" for Cancel Call Forward, fol-

lowed by the [REMOVE] key will be displayed as:

```
CANCEL CALL FWD  
* 7 3 R  
SAVE : save ?
```

This programming will cause the phone to dial "\*\*73" and then the phone will hang up.

Press the [SAVE] key to complete programming the number. The LCD will display:

```
Save to Public ?  
< > : select  
SAVE : save ?
```

Press the NAVIGATION [>] key to select the Private Directory. The LCD will display:

```
Save to Private ?  
< > : select  
SAVE : save ?
```

Press the NAVIGATION [>] key to select the Speed Dial mode. The LCD will display:

```
Save to SPD# ?  
< > : select  
SPD# : save ?
```

After choosing the Public Directory or Private Directory or SPD#, press the [SAVE] key to complete the programming process. If the SPD# is selected, press the [SPD#] key to complete the programming process. The LCD will display:

```
Save to Public ?  
< > : select  
Saved !
```

or

```
Save to Private ?  
< > : select  
Saved !
```

or

```
Save to SPD# ?  
< > : select  
Saved !
```

## Viewing a Directory Entry

**NOTE:** A new station's Public Directory will be updated from the other phones. The time to complete the update will vary.

To view information in a Directory, press the [DIRECTORY] key. The LCD will display:

```
DIRECTORY
< > : select
Public/Private
```

Press the NAVIGATION [<] or NAVIGATION [>] key to select the directory for viewing. The LCD will display:

```
Public DIR
< > : select
Public/Private
```

or

```
Private DIR
< > : select
Public/Private
```

Rotate the [JOG] knob to scroll to the item for viewing.

Or

repeatedly press the dial keypad that has the letters or symbols, until the display shows the letter or symbol for viewing.

For example, rotate the [JOG] knob clockwise. The LCD will display:

```
AARON
1 2 3 4 5 6 7
* : EDIT
```

Then press the "J". The LCD will display:

```
JIM
5 5 5 1 2 3 4
* : EDIT
```

However, if there were no entries for "J", the LCD will display:

```
No Entries
for "J"
```

Rotate the [JOG] knob clockwise to find the next item. For example, the LCD will display:

```
KEVIN
5 5 5 5 1 5 1
* : EDIT
```

Rotate the [JOG] knob counter clockwise to move to the previous entry. For example, the LCD will display:

```
IRENE
5 5 5 9 8 7 6
* : EDIT
```

## Editing a Directory Entry

To edit a number previously stored in a Directory, view the entry. For example, the LCD will display:

```
AARON
1 2 3 4 5 6 7
* : EDIT
```

Press the [\*] key and begin to edit the name. The LCD will display:

```
AARON □
1 2 3 4 5 6 7
SAVE : save ?
```

Press the [SAVE] key when done editing the name and begin to edit the number.

**NOTE:** To enter a number from the Last Number Redial, the old number must first be completely erased using the NAVIGATION [<] key (then press the [REDIAL] key). The LCD will display:

```
P E T E
1 2 3 4 5 6 7 □
S A V E : s a v e ?
```

Press the [SAVE] key to store the info. See the Programming the Directory section above for the instructions to complete the storing process.

## Dialing a Directory Entry

To dial a number from the Directory, view the entry. For example, the LCD will display:

```
A A R O N
1 2 3 4 5 6 7
* : E D I T
```

Press the Center of the [JOG] knob. The telephone will go off-hook on an available CO Line in the previous mode (handsfree

or headset) and dial the number.

or

Pick up the handset. The telephone will go off-hook on an available CO Line and dial the number.

or

To select a desired CO Line and dial, while viewing the Directory entry, press the desired [CO Line] key.

In all cases, the LCD will display:

```
1 2 3 4 5 6 7 □
0 0 : 0 1
C I D : 1 0 0 / 1 9 8
```

## Erasing a Single Directory Entry

To erase an entry from the Directory, view the Directory entry to be erased. Press the [REMOVE] key. The LCD will display:

```
A A R O N
1 2 3 4 5 6 7
R E M O V E : r e m o v e ?
```

Press the [REMOVE] key again within 3-seconds. The entry will be erased and the LCD will display:

```
( e m p t y )
R e m o v e d !
```

## Erasing All Public or Private Directory Entries

To erase all entries from the Public or Private Directory, press the [DIRECTORY] key. The LCD will display:

```
D I R E C T O R Y
< > : s e l e c t
P u b l i c / P r i v a t e
```

Press the NAVIGATION [>] or NAVIGATION [<] key to select the directory for viewing. The LCD will display:

```
P u b l i c D I R
< > : s e l e c t
P u b l i c / P r i v a t e
```

or



```
Private DIR
<>:select
Public/Private
```

Press the [REMOVE] key. The LCD will display:

```
Public DIR
REMOVE:all?
```

or

```
Private DIR
REMOVE:all?
```

Press the [REMOVE] key again within 3-seconds. All the entries in the selected Directory will be erased. The LCD will display:

```
(empty)
All Removed!
```

Any change to the Public Directory of a station will automatically cause the Public Directory of each station to be updated.

Also, all directories may be updated when a new station is added to the system.

### Viewing a Speed Dial Entry

To view the information in a Speed Dial, press the [SPD#] key. The LCD will display:

```
AARON
1 2 3 4 5 6 7
*:EDIT
```

or, if empty:

```
(empty)
*:EDIT
```

### Editing a Speed Dial Entry

To edit the information in a Speed Dial, press the [SPD#] key. The LCD will display:

```
AARON
1 2 3 4 5 6 7
*:EDIT
```

or, if empty:

```
(empty)
*:EDIT
```

Press the [\*] key and start editing the name. The LCD will display:

```
AARON □
1 2 3 4 5 6 7
SAVE:save?
```

or, if empty:

```
□ (Enter name)
SAVE:save?
```

Press the [SAVE] key to keep the name and start editing the number. For example, the LCD will display:

```
TERRY
2 3 4 5 6 7 8 □
SAVE:save?
```

or, if empty:

```
T E R R Y
□ ( E n t e r n u m b e r )

S A V E : s a v e ?
```

Press the [SAVE] key when finished entering the number. Press the [SPD#] key to complete the edit process and save the information in the Speed Dial key. The LCD will display:

```
S a v e t o S P D # ?

< > : s e l e c t
S a v e d !
```

## Dialing a Speed Dial Entry

To dial a Speed Dial key, press the [SPD#]. The display will show the information. For example, the LCD will display:

```
A A R O N
1 2 3 4 5 6 7

* : E D I T
```

Press the Center of the [JOG] knob. The telephone will go off-hook on an available CO Line in the previous mode (handsfree

or headset) and dial the number.  
or  
Pick up the handset. The telephone will go off-hook on an available CO Line and dial the number.  
or  
To select a desired CO Line and dial, while viewing the entry, press the desired [CO Line] key.

In all cases, the LCD will display:

```
1 2 3 4 5 6 7 □
0 0 : 0 1
C I D : 1 0 0 / 1 9 8
```

## Erasing a Speed Dial Entry

To erase the information in a Speed Dial location, press the [SPD#]. The display will show the information. For example, the LCD will display:

```
A A R O N
1 2 3 4 5 6 7

* : E D I T
```

Press the [REMOVE] key to start the delete process. The LCD will display:

```
A A R O N
1 2 3 4 5 6 7

R E M O V E : r e m o v e ?
```

Press the [REMOVE] key again within 3-seconds to delete the item. The LCD will display:

```
( e m p t y )

R e m o v e d !
```

## CALLER ID OPERATION

When a telephone call is received, the NSQ412's display can show the calling person's name and the calling number. You must have Caller ID with name and number delivery as well as Call Waiting with Caller ID service to take full advantage of the Caller ID features. The telephone does not provide these features, you must order them beforehand from your local telephone company. Check with your local phone company to confirm that both of these services are available in your area.

If you have only Caller ID service, you will not receive or display Call Waiting Caller ID information.

## Setting Up the Caller ID Operation

Different telephone companies offer different dialing plans, which may or may not require the user to dial a "1" when dialing toll calls. Some areas require 7-digit dialing for local calls while other areas require 10-digits.

The NSQ412 can be programmed to work in all of these areas. Each station provides one programmable home area code and five programmable local area codes. These programmable area codes will determine how a Caller ID number is displayed, stored and dialed. When the calling number originates from the area code that matches the one programmed into the Home Area Code, the LCD will display and dial only the local, 7-digit calling number. For example:

1 2 / 2 6	1 2 : 0 8 P
L 1	
J A N E D O E	
5 5 5 3 3 3 3	

When the calling number originates from the area code that matches one programmed into a Local Area Code, the LCD will display and dial the regional, 10-digit number (area code + local 7-digit number). For example:

1 2 / 2 6	1 2 : 0 8 P
L 3	
J O H N S M I T H	
8 1 2 5 5 2 2 2 2	

When the calling number does not originate from any of the programmed area codes, the LCD will display the actual number when the calling number is less than 10-digits long. For example:

1 2 / 2 6	1 2 : 0 8 P
L 2	
P A U L S H O R T	
2 1 3 0	

**See the section Area Code Programming to set up the station for proper Caller ID display.**

## Receiving Caller ID

When received during ringing, the Caller ID info will appear in the display. For example, the LCD will display:

1 2 / 2 6	1 2 : 0 8 P
L 2	
J O H N S M I T H	
5 5 5 2 2 2 2	

"12/26 12:08P"	The current time.
"L2"	The CO Line which received the call.
"JOHN SMITH"	The caller's name.
"5552222"	The caller's phone number.

The display will return to its previous display under the following conditions:

- In 4 - 6 seconds after ringing stops from the caller hanging up.
- The call is answered by another system phone.
- The phone that answers the call ends the call.

When ringing occurs on two or more lines at the same time, the display will show the latest Caller ID information received. For example, L3 begins to ring, followed by L1 and then L2. As the Caller ID data is received on each line, it is displayed until the next one is received. For example, L3 rings and the LCD will display:

```

1 2 / 2 6      1 2 : 0 8 P
L 3
J O H N   S M I T H
5 5 5 2 2 2 2

```

Then L1 begins ringing and the LCD will display:

```

1 2 / 2 6      1 2 : 0 8 P
L 1
J A N E   D O E
5 5 5 3 3 3 3

```

Then L2 begins ringing and the LCD will display:

```

1 2 / 2 6      1 2 : 0 9 P
L 2
J I M   J O N E S
5 5 5 4 4 4 4

```

The Caller ID information from the other lines can be viewed by pressing the [CALLER] key. The display will then show the next higher ringing line. If there are no higher lines ringing, the display will go to the general display. Following the general display, the lowest ringing line will be displayed.

Using the example shown above, pressing the [CALLER] key after L2 begins to

ring will cause the display to show the L3 info.

```

1 2 / 2 6      1 2 : 0 8 P
L 3
J O H N   S M I T H
5 5 5 2 2 2 2

```

Pressing the [CALLER] key again shows the general display:

```

1 2 / 2 6      1 2 : 0 9 P
E X T  1 2
C I D : 1 0 3 / 2 0 0

```

Pressing the [CALLER] key again shows L1 info:

```

1 2 / 2 6      1 2 : 0 8 P
L 1
J A N E   D O E
5 5 5 3 3 3 3

```

Pressing the [CALLER] key again shows L2 info:

```

1 2 / 2 6      1 2 : 0 9 P
L 2
J I M   J O N E S
5 5 5 4 4 4 4

```

There are other possible displays that depend upon the Caller ID info. They

include:

**Display**

- Private Name
- Private Number
- Unknown Name
- Unknown Number
- Unknown Caller
- No CID displayed

**Meaning**

- The calling party has blocked the name information
- The calling party has blocked the number information
- The phone company is unable to provide the caller's name
- The phone company is unable to provide the caller's number
- The call information is out of area
- No data was received or the data was bad

**NOTE 1:** When multiple CO Lines are ringing at the same time, going off-hook will cause the telephone to answer the CO Line that has the Caller ID information shown in the LCD display.

**NOTE 2:** The display may not show the Caller ID information if the call is answered before the second ring.

The Caller ID data is received from the telephone office between the first and second ring.

The MSG Wait/New CID LED will illuminate continuously when an unviewed Caller ID record is in the Caller List (the Voicemail operation of this LED has priority over the Caller List operation). After all new records in the Caller List have been viewed, the MSG Wait/New CID LED will turn off. **NOTE:** The MSG Wait/New CID LED can be disabled for the Caller List indication in programming. This does not affect the message waiting indication.

### Viewing the Caller ID List

To review the Caller List, press the [CID LIST] key while the station is idle. The LCD will display the summary information. For example, the LCD will display:

```
CID LIST
198 Calls
115 New
```

Rotate the [JOG] knob counter clockwise to view the latest caller information or clockwise to view the oldest caller information.

For example, the LCD will display:

```
12/26      12:19P
CL#001 NEW   L3
JIM JONES
5554444
```

12/26 12:19P: The time when the call was received.  
CL#001: The record number in the CID database.  
NEW: This is new CID data (not viewed before).  
L3: The CO Line which the call was received on.  
JIM JONES: The caller's name.  
5554444 The caller's telephone number.

While viewing a call record, rotating the [JOG] knob counter clockwise will display the information from the previous call. Rotating the [JOG] knob clockwise will display the information of the next newer call. Repeatedly rotating the [JOG] knob will guide the user through the list forward and backward.

### Erasing All Caller ID Records

To remove all the records in the Caller

List, press the [CID LIST] key when the station is idle. The LCD will display the CID summary information. Press the [REMOVE] key to begin the delete process. The LCD will display:

```
CID LIST
REMOVE: all?
```

Press the [REMOVE] key again within 3-seconds to confirm the removal. The LCD will display:

```
(empty)
All Removed!
```

After approximately 5-seconds, the LCD will return to the CID summary screen.

### Erasing a Single Caller ID Record

To remove a single record from the Caller List, display the record to delete. For example, the LCD will display:

```
12/27      02:33P
CL#174      L2
BOB JONES
5557777
```

Press the [REMOVE] key to begin deleting the record. The LCD will display:

```
1 2 / 2 7      0 2 : 3 3 P
CL # 1 7 4      L 2
BOB JONES
REMOVE : r e m o v e ?
```

Press the [REMOVE] key again within 3-seconds to confirm the deletion. The LCD will display:

```
CL # 1 7 4

R e m o v e d !
```

After approximately 5-seconds, the LCD will return to the CID Summary screen.

## Dialing a Caller ID Record

To dial a telephone number from the Caller's List, display the record to be called. Press the Center of the [JOG] knob. The telephone will go off-hook on an available CO Line in the previous mode (handsfree or headset) and dial the number.

or  
Pick up the handset. The telephone will go off-hook on an available CO Line and

dial the number.

or

To select a desired CO Line and dial, while viewing the entry, press the desired [CO Line] key.

In all cases for example, the LCD will display:

```
1 2 3 4 5 6 7 □
0 0 : 0 1
CID : 1 0 0 / 1 9 8
```

**NOTE:** Be sure to read the section Area Code Programming to make sure the CID number is stored and dialed in the correct format (7-digit, 10 digit or 11-digit dialing). When the calling number does not originate from any of the programmed area codes, the LCD will dial a 1 + the entire number when the calling number is 10-digits or longer.

## Storing a Caller ID Record

To save a record from the Caller's List into the Directory or a Speed Dial location, display the record to be saved. For example, the LCD will display:

```
0 3 / 2 5      0 3 : 4 2 P
CL # 1 3 2      L 1
SALLY PETERS
5 5 5 6 7 6 7
```

Press the [RELEASE] key to quit the Caller's List. Press the [DIRECTORY] key. The LCD will display:

```
DIRECTORY

< > : s e l e c t
      P u b l i c / P r i v a t e
```

Press the [SAVE] key to start to enter the name. The LCD will display:

```
□ ( E n t e r n a m e )

S A V E : s a v e ?
```

Press the [CID LIST] to copy the Caller ID name and number from the Caller List to the display. For example, the LCD will display:

```
SALLY PETERS □
5 5 5 6 7 6 7

S A V E : s a v e ?
```

The NAVIGATION [<] and [>] keys can be used to edit the name. Press the [SAVE] key to confirm the name and begin to edit the phone number. The LCD will display:

```
SALLY PETERS
5 5 5 6 7 6 7 □
SAVE : s a v e ?
```

The NAVIGATION [<] and [>] keys can be used to edit the number. Press the [SAVE] key to confirm the number and start the process for saving to a Directory or Speed Dial location. Follow the instructions in the Programming the Directory section to complete this process.

### The Caller ID for Call Waiting Feature

Each telephone can display Caller ID for Call Waiting calls (Type 2 Caller ID). The Call Waiting Caller ID will be displayed for 20-seconds, then the LCD will return to the previous display. For example, the LCD will display:

```
□
L2 (CallWaiting)
MARK QUARK
5 5 5 8 6 7 5
```

## MESSAGE WAITING AND NEW CID INDICATION

The MSG WAIT/NEW CID LED will illuminate steady when new, unviewed Caller ID entries have been received. If you have a voicemail service with your local telephone company, the indicator will flash to alert you to check for new voicemail messages.

The NSQ412's message waiting detection will recognize the presence of new Voicemail left in a telephone company's mailbox (subscribed to by the user). This is done by detecting stutter dial tone and also by detecting a FSK Visual Message Waiting Indicator On signal, both of which are provided by the telephone company. The display of each station will show each line that has detected the presence of a voicemail. For example, the LCD will display:

12/26	12:08P
EXT 12	MSGW-134
CID: 100/198	

"12/26 12:08P" The current time.  
"EXT 12" The station number of this phone is 12.  
"CID: 100/198" 100 new Caller ID messages, and 198 total Caller ID messages.  
"MSGW-134" CO lines 1, 3 and 4 have messages waiting.

The telephone will recognize when new voicemails no longer exist. This is accomplished by detecting the absence of stutter dial tone (continuous dial tone) and also by detecting a FSK Visual Message Waiting Indicator Off signal, both of which are provided by the telephone company. The display shall remove the message waiting indication for each line, which no longer has a voicemail. When no voicemails are on any line, the MSG WAIT/NEW CID LED shall cease to flash.

If you are in an area where an FSK is not available:

1. The system will check your line for stutter dial tone every time you hang up or each time a call goes unanswered.

The station will indicate a message is waiting when there is stutter dial tone.

2. You may experience some delay in seeing the message waiting indication turn off when no new messages are in the voicemail box. This is due to regulatory operation requirements and does not indicate a problem with the station.

**NOTE:** The message indicators may not be activated or deactivated under certain conditions. For example, when you retrieve messages from an outside phone (not your own telephone number), they may not be canceled when you return home. If you experience this, pick up the handset for several seconds and hang up. The message indicators will go out in a short time.

The message indicators can be reset to on or off for each line or all lines in programming mode.



## Getting Started

The following list explains each item that can be set during programming. **NOTE:** An asterisk next to a setting indicates the item's default setting.

Item Name	Setting	Function
LANGUAGE	English*/Spanish	Language setting
TIME/DATE	01/01 01:00A*	Calendar setting
EXTENSION NO	11*,12,13,....,21,22	Extension number
MSGW ON/OFF	On*/Off*	Turn on/off Message Waiting indicators
RINGER ON/OFF	On*/Off	Ring On/Off setting
RINGER TYPE	Type 1*,2,3,4	Select different ring frequency
DELAY RING	Off*,2,4,6,....,30 sec	Delayed ring duration setting
LINE USAGE	On*/Off	Line usage setting
PRIME LINE	Line 1*, 2, 3,4	Select auto-pickup line when off-hook
LINE GROUP	Line group 2, 3,....,15 or private-line 2* for CO Line 2 3* for CO Line 3 4* for CO Line 4	The non-square line setting for the CO Line 2, CO Line 3 or CO Line 4
AUTO-MUTE	On*/Off	Auto-mute setting while being paged by someone
TONE/PULSE	Tone*/Pulse	Dial type setting
FLASH TIME	100mS - 1200mS, 600mS*	Flash time duration setting
HOLD REMINDER	On*/Off	Turn on/off hold reminder
NEW CID LED	On*/Off	Turn on/off New CID LED function
AREA CODES	1 - 3 digits, Empty*	1 home/5 local area codes
RESET ALL	(default values)	Restore all settings to default

The following list explains the keys that are used during programming:

Keys to use	Programming function
[PROGRAM]	Enter the programming operation
[JOG] knob	Scroll among the programming items or values
NAVIGATION [<]	Return to the previous programming level or perform a back-space while editing
NAVIGATION [>]	Enter the next lower programming level
[REMOVE]	Remove the current setting and return to the default value
[SAVE]	Save the current setting
[RELEASE]	Quit the programming operation

Press the [PROGRAM] key while the extension is idle to start the programming mode. The LCD will display:

```
PROGRAM
Turn Dial
```

Rotate the [JOG] knob repeatedly until the display shows the programming item to be set. Follow the display prompts to select the setting needed. A single beep is heard if programming succeeds. A double beep is heard if programming fails.

If no key is pressed in approximately twenty seconds, the programming operation will be automatically canceled.

NOTE: Programming will automatically disable after 120 seconds while setting the Time/Date. Any programming changes not entered with the [SAVE] key will be lost.

## Language Programming

The LCD prompts can display in English or Spanish. To program the Language, enter the programming mode and turn the [JOG] knob until the display shows LANGUAGE. The LCD will display:

```
LANGUAGE
Turn Dial
>: enter
```

Press the NAVIGATION [>] key to enter the Language setup mode. Rotate the [JOG] knob to select English or Spanish. The LCD will display:

```
LANGUAGE
= English
Turn Dial
SAVE: save?
```

or

```
LANGUAGE
= Spanish
Turn Dial
SAVE: save ?
```

Press the [SAVE] key to confirm the setting. The LCD will display:

```
LANGUAGE
= Spanish
Programmed!
```

After approximately five seconds, the display will return to the highest level of the current setting.

## Time and Date Programming

The station will display the date and time. A real time clock keeps it current. They must be set in programming. To program the Time/Date, enter the programming mode and turn the [JOG] knob until the display shows TIME/DATE. The LCD will display:

```
TIME / DATE
Turn Dial
>: enter
```

Press the NAVIGATION [>] key to begin selecting the month. Rotate the [JOG] knob to select the month. The LCD will display:

```
MONTH
01 / 01    01:00 A
Turn Dial
SAVE: save ?
```

:

```
MONTH
12 / 01    01:00 A
Turn Dial
SAVE: save ?
```

Press the [SAVE] key to store the month setting. The unit will then enter the date mode. Rotate the [JOG] knob to select the day. The LCD will display:

```
DATE
12 / 01    01:00 A
Turn Dial
SAVE: save ?
```

:

```
DATE
12 / 31    01:00 A
Turn Dial
SAVE: save ?
```

**NOTE:** The unit will not display illegal days (for example, February 30 or April 31). Press the [SAVE] key to store the date setting. The unit will then enter the hour mode. Rotate the [JOG] knob to select the hour. The LCD will display:

```
HOOR
12 / 31    01:00 A
Turn Dial
SAVE: save ?
```

:

```
HOOR
12 / 31    12:00 A
Turn Dial
SAVE: save ?
```

Press the [SAVE] key to store the HOUR setting. The unit will then enter the minutes mode. Rotate the [JOG] knob to select the minutes. The LCD will display:

```
MINUTES
12 / 31    12:00 A
Turn Dial
SAVE: save ?
```

:

```
MINUTES
1 2 / 3 1      1 2 : 5 9 A
Turn Dial
SAVE : save ?
```

Press the [SAVE] key to store the minutes setting. The unit will then enter the AM/PM mode. Rotate the [JOG] knob to select the AM/PM. The LCD will display:

```
AM / PM
1 2 / 3 1      1 2 : 5 9 A
Turn Dial
SAVE : save ?
```

or

```
AM / PM
1 2 / 3 1      1 2 : 5 9 P
Turn Dial
SAVE : save ?
```

Press the [SAVE] key to store the AM/PM setting. The LCD will display:

```
AM / PM
1 2 / 3 1      1 2 : 5 9 P
Programmed!
```

After approximately five seconds, the display will return to the highest level of the current setting.

## Programming the Station Number

Each station must have a different station number. If two stations have the same number, one will continuously emit a ring tone after initializing. To program the Extension Number, enter the programming mode and turn the [JOG] knob until the display shows EXTENSION NO. The LCD will display:

```
EXTENSION NO
Turn Dial
> : enter
```

Press the NAVIGATION [>] key to begin selecting the Extension Number. **NOTE:** The default extension number is 11. Rotate the [JOG] knob to select the extension number. The LCD will display:

```
EXTENSION NO
= 1 1
Turn Dial
SAVE : save ?
```

:

```
EXTENSION NO
= 2 2
Turn Dial
SAVE : save ?
```

Press the [SAVE] key to accept the setting. The LCD will display:

```
EXTENSION NO
= 2 2
Programmed!
```

After approximately five seconds, the display will return to the highest level of the current setting.

## Message Waiting Indicator Programming

The MSGW Waiting indicators may be manually turned on or off. To program the MSGW indicators for CO Lines, enter the programming mode and turn the [JOG] knob until the display shows MSGW ON/OFF. The LCD will display:

```
MSGW ON/OFF
Turn Dial
> : enter
```

Press the NAVIGATION [>] key to begin to change the setting. Rotate the [JOG] knob to select the CO Line. The LCD will display:

```
L1 MSGW ON/OFF
Turn Dial
>: enter
```

:

```
L4 MSGW ON/OFF
Turn Dial
>: enter
```

or

```
ALL MSGW ON/OFF
Turn Dial
>: enter
```

(MSGW indicators for all CO Lines will be turned on or off)

Press the NAVIGATION [>] key to select which CO Line(s) to change. Rotate the [JOG] knob to select On/Off. For example, the LCD will display:

```
L3 MSGW ON/OFF
= On
Turn Dial
SAVE: save?
```

or

```
L3 MSGW ON/OFF
= Off
Turn Dial
SAVE: save?
```

Press the [SAVE] key to confirm the setting. For example, the LCD will display:

```
L3 MSGW ON/OFF
= Off

Programmed!
```

After approximately five seconds, the display will return to the highest level of the current setting. **NOTE:** When a new voice mail message is received the VMWI light will flash automatically. Turning the VMWI light on/off does not disable the Voice Mail feature and the phone's ability to detect the FSK or Stutter Dial Tone provided by your telephone company.

### Ringer On or Off Programming

The ringer may be turned off or on for

any of the lines. To program the Ringers for each CO Line, enter the programming mode and turn the [JOG] knob until the display shows RINGER ON/OFF. The LCD will display:

```
RINGER ON/OFF
Turn Dial
>: enter
```

Press the NAVIGATION [>] key to begin the Ringer On/Off programming. Rotate the [JOG] knob to change the CO Line number. The LCD will display:

```
L1 RINGER ON/OFF
Turn Dial
>: enter
```

:

```
L4 RINGER ON/OFF
Turn Dial
>: enter
```

or

```
ALLRINGER ON/OFF
Turn Dial
SAVE: save?
```

Press the NAVIGATION [>] key to select which CO Line(s) to change. Rotate the [JOG] knob to select On/Off. For example, the LCD will display:

```
L3 RINGER ON/OFF
= On
Turn Dial
SAVE: save ?
```

or

```
L3 RINGER ON/OFF
= Off
Turn Dial
SAVE: save ?
```

Press the [SAVE] key to confirm the setting. The LCD will display:

```
L3 RINGER ON/OFF
= Off
Programmed!
```

After approximately five seconds, the display will return to the highest level of the current setting.

## Ringer Type Programming

The ringer sound may be set to one of four different types for each line. To pro-

gram the Ringer Type for each CO Line, enter the programming mode and turn the [JOG] knob until the display shows RINGER TYPE. The LCD will display:

```
RINGER TYPE
Turn Dial
>: enter
```

Press the NAVIGATION [>] key to begin programming the Ringer Type. Rotate the [JOG] knob to change the CO Line number. The LCD will display:

```
L1 RINGER TYPE
Turn Dial
>: enter
```

```
:
```

```
L4 RINGER TYPE
Turn Dial
>: enter
```

Press the NAVIGATION [>] key to select which CO Line to change. You will hear the ringer sound currently shown in the display. Rotate the [JOG] knob to select the Ringer Type. For example, the LCD will display:

```
L3 RINGER TYPE
= Type 1
Turn Dial
SAVE: save ?
```

```
:
```

```
L3 RINGER TYPE
= Type 4
Turn Dial
SAVE: save ?
```

Press the [SAVE] key to confirm the ringer type. For example, the LCD will display:

```
L3 RINGER TYPE
= Type 2
Programmed!
```

After approximately five seconds, the display will return to the highest level of the current setting.

## Delayed Ring Programming

A station may be set to delay the phone from ringing from 2 to 30 seconds after a call comes in. This feature will function on all telephone lines connected to the station when active. To program the Delayed Ring, enter the programming mode and turn the [JOG] knob until the display shows DELAY RING. The LCD will display:

```
DELAY RING
Turn Dial
>: enter
```

Press the NAVIGATION [>] key to begin programming the Delayed Ring. Rotate the [JOG] knob to change the delay time. The LCD will display:

```
DELAY RING
= Off
Turn Dial
SAVE: save ?
```

or

```
DELAY RING
= 02 sec
Turn Dial
SAVE: save ?
```

:

```
DELAY RING
= 30 sec
Turn Dial
SAVE: save ?
```

Press the [SAVE] key to confirm the selection. For example, the LCD will display:

```
DELAY RING
= 16 sec

Programmed!
```

After approximately five seconds, the display will return to the highest level of the current setting.

## Line Usage Programming

Each of the lines can be disabled. This will turn off the [CO Line] key and LED. Use this for any lines on the station that are not wired to a telephone number. To program the Line Usage, enter the programming mode and turn the [JOG] knob until the display shows LINE USAGE. The LCD will display:

```
LINE USAGE
Turn Dial
>: enter
```

Press the NAVIGATION [>] key to begin programming the Line Usage. Rotate the [JOG] knob to change the CO Line number. The LCD will display:

```
L1 USAGE
Turn Dial
>: enter
```

:

```
L4 USAGE
Turn Dial
>: enter
```

Press the NAVIGATION [>] key to select the CO Line. Rotate the [JOG] knob to change the Line Usage. For example, the LCD will display:

```
L3 USAGE
= On
Turn Dial
SAVE: save ?
```

or

```
L 3  U S A G E
=   O f f
T u r n   D i a l
S A V E : s a v e ?
```

Press the [SAVE] to confirm the setting. The LCD will display:

```
L 3  U S A G E
=   O f f
Programmed!
```

After approximately five seconds, the display will return to the highest level of the current setting.

## Prime Line Preference Programming

The Prime Line is the one that has the highest priority to go off-hook when the station is idle and you lift the handset, press the [SPEAKER] or [HEADSET] keys. To program the Prime Line Preference, enter the programming mode and turn the [JOG] knob until the display shows PRIME LINE. The LCD will display:

```
P R I M E   L I N E
T u r n   D i a l
> :   e n t e r
```

Press the NAVIGATION [>] key to begin to select the Prime Line. Rotate the [JOG] knob to change the selection. For example, the LCD will display:

```
P R I M E   L I N E
=   L 1
T u r n   D i a l
S A V E : s a v e ?
```

:

```
P R I M E   L I N E
=   L 4
T u r n   D i a l
S A V E : s a v e ?
```

Press the [SAVE] key to confirm the selection. For example, the LCD will display:

```
P R I M E   L I N E
=   L 3
Programmed!
```

After approximately five seconds, the display will return to the highest level of the

current setting.

## Line Group Programming

This setting allows lines 2, 3 and 4 to have different telephone numbers for different stations (non-square). Stations sharing the same telephone numbers on a line need to be programmed as part of the same group. To program the Line Group, enter the programming mode and turn the [JOG] knob until the display shows LINE GROUP. The LCD will display:

```
L I N E   G R O U P
T u r n   D i a l
> :   e n t e r
```

Press the NAVIGATION [>] key to begin programming the Line Group. Rotate the [JOG] knob to change the CO Line. The LCD will display:

```
L 2   G R O U P
T u r n   D i a l
> :   e n t e r
```

:



```
L 4 G R O U P
Turn Dial
> : e n t e r
```

Press the NAVIGATION [>] key to select the CO Line. Rotate the [JOG] knob to change the Line Group. The LCD will display:

```
L 4 G R O U P
= L 0 4
Turn Dial
SAVE : s a v e ?
```

:

```
L 4 G R O U P
= L 1 5
Turn Dial
SAVE : s a v e ?
```

or

```
L 4 G R O U P
= P R V
Turn Dial
SAVE : s a v e ?
```

**NOTE:** Two different lines on the same station cannot belong to the same Group. That selection will not be avail-

able during programming.

Press the [SAVE] key to confirm the selection. For example, the LCD will display:

```
L 4 G R O U P
= L 1 2
Programmed!
```

After approximately five seconds, the display will return to the highest level of the current setting.

### Auto-Mute Programming

The Auto-Mute feature determines whether a paged station's microphone is automatically enabled or disabled. To program the Auto-Mute, enter the programming mode and turn the [JOG] knob until the display shows AUTO-MUTE. The LCD will display:

```
A U T O - M U T E
Turn Dial
> : e n t e r
```

Press the NAVIGATION [>] key to begin programming the Auto-Mute. Rotate the

[JOG] knob to change the selection. The LCD will display:

```
A U T O - M U T E
= O n
Turn Dial
SAVE : s a v e ?
```

or

```
A U T O - M U T E
= O f f
Turn Dial
SAVE : s a v e ?
```

Press the [SAVE] key to confirm the setting. The LCD will display:

```
A U T O - M U T E
= O f f
Programmed!
```

After approximately five seconds, the display will return to the highest level of the current setting.

## Tone or Pulse Dial Programming

The station can be set to dial in Tone or Pulse. To program the Tone/Pulse dial, enter the programming mode and turn the [JOG] knob until the display shows TONE/PULSE. The LCD will display:

```
TONE/PULSE
= Pulse
Turn Dial
>: enter
```

Press the NAVIGATION [>] key to begin programming the Tone/Pulse dialing. Rotate the [JOG] knob to change the selection. The LCD will display:

```
TONE/PULSE
= Tone
Turn Dial
SAVE: save?
```

or

```
TONE/PULSE
= Pulse
Turn Dial
SAVE: save?
```

Press the [SAVE] key to confirm the selection. The LCD will display:

```
TONE/PULSE
= Pulse
Programmed!
```

After approximately five seconds, the display will return to the highest level of the current setting.

## Flash Time Programming

The amount of time the station opens the telephone line when the [FLASH] key is pressed can be changed. To program the Flash Time, enter the programming mode and turn the [JOG] knob until the display shows FLASH TIME. The LCD will display:

```
FLASH TIME
Turn Dial
>: enter
```

Press the NAVIGATION [>] key to begin programming the Flash Time. Rotate the [JOG] knob to change the selection. The LCD will display:

```
FLASH TIME
= 0.1 sec
Turn Dial
SAVE: save?
```

:

```
FLASH TIME
= 1.2 sec
Turn Dial
SAVE: save?
```

Press the [SAVE] key to confirm the setting. The LCD will display:

```
FLASH TIME
= 1.2 sec
Programmed!
```

After approximately five seconds, the display will return to the highest level of the current setting.

## Hold Reminder Programming

The station will emit a reminder tone every 30 seconds when it put a line on hold. This can be disabled. To program the Hold Reminder, enter the programming mode and turn the [JOG] knob until the display shows HOLD REMINDER.

The LCD will display:

```
HOLD REMINDER
Turn Dial
> : enter
```

Press the NAVIGATION [>] key to begin programming the Hold Reminder. Rotate the [JOG] knob to change the selection. The LCD will display:

```
HOLD REMINDER
= On
Turn Dial
SAVE : save ?
```

or

```
HOLD REMINDER
= Off
Turn Dial
SAVE : save ?
```

Press the [SAVE] key to confirm the

selection. The LCD will display:

```
HOLD REMINDER
= Off

Programmed!
```

After approximately five seconds, the display will return to the highest level of the current setting.

## New CID LED Programming

The New CID LED feature can be disabled or enabled. To program the New CID LED, enter the programming mode and turn the [JOG] knob until the display shows NEW CID LED. The LCD will display:

```
NEW CID LED
Turn Dial
> : enter
```

Press the NAVIGATION [>] key to begin programming the New CID LED. Rotate the [JOG] knob to change the selection. The LCD will display:

```
NEW CID LED
= On
Turn Dial
SAVE : save ?
```

or

```
NEW CID LED
= Off
Turn Dial
SAVE : save ?
```

Press the [SAVE] key to confirm the setting. The LCD will display:

```
NEW CID LED
= Off

Programmed!
```

After approximately five seconds, the display will return to the highest level of the current setting.

## Area Code Programming

There is one location for a Home Area Code. The station uses it to remove the area code from the Caller ID number displayed in the LCD. It usually is programmed with the area code that phone is located in.

There are five locations for Local Area Codes. Programming a Local Area Code will cause the Caller ID number to display and dial a call in a 10-digit format. Program each area code that you can make 10-digit calls to. To program the Area Codes, enter the programming mode and turn the [JOG] knob until the display shows AREA CODES. The LCD will display:

```
AREA CODES
Turn Dial
> : enter
```

Press the NAVIGATION [>] key to begin programming the Area Codes. Rotate the [JOG] knob to select the type of area code. The LCD will display:

```
Home Area Code
= (empty)
Turn Dial
> : enter
```

then

```
Loc. Area Code 1
= (empty)
Turn Dial
> : enter
```

```
:
Loc. Area Code 5
= (empty)
Turn Dial
> : enter
```

**NOTE:** In the above examples, no area codes are programmed. Numbers would replace the text "(empty)" if a location were previously programmed.

Press the NAVIGATION [>] key to begin programming one of the area codes. Enter the three digits using the keypad. For example the LCD will display:

```
Loc. Area Code 2
= 123 □
(Enter digits)
SAVE: save?
```

Use the NAVIGATION [<] key to move the cursor left or erase a number. Press the [Save] key to confirm the selection.

```
Loc. Area Code 2
= 123
Programmed!
```

After approximately five seconds, the display will return to the highest level of the

current setting. Repeat the above steps to program additional area codes.

## Reset All Programming

This feature returns all programming to the factory default settings. It erases the Caller ID records, Directory and Speed Dial programming at the station. **NOTE:** The Public Directory will be temporarily erased, but will regain its programming shortly after the reset is complete. To perform the Reset All function, enter the programming mode and turn the [JOG] knob until the display shows RESET ALL. The LCD will display:

```
RESET ALL
Turn Dial
> : enter
```

Press the NAVIGATION [>] key to begin the Reset All process. The LCD will display:

```
RESET ALL?
REMOVE: reset all
```

Press the [REMOVE] key within 3-seconds to confirm the Rests All function. The LCD will display:

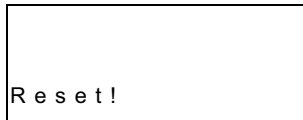

## CARE AND MAINTENANCE

Place your phone in a location where its cords will be out of the way and where it is not likely to be knocked to the floor.

To clean, use a soft cloth, dampened in mild detergent. Never use abrasives or solvents and never spray cleaners directly onto the telephone.

## RADIO FREQUENCY INTERFERENCE

**WARNING!** This equipment generates, uses and can radiate radio frequency energy and if not connected and operated in accordance with the Owner's Manual, may cause interference to radio communications. It has been tested and

found to comply with the limits for a Class A computing device pursuant to Subpart J of Part 15 of the FCC Rules which are designed to provide reasonable protection against such interference when operated in a commercial environment. Operation of this equipment in a residential area is likely to cause interference in which case the user at his own expense will be required to take whatever measures may be required to correct the interference.

## PROBLEMS YOU CAN SOLVE

### STATION IS RINGING CONTINUOUSLY

Make sure the station number is different than the other stations being used.

### CANNOT DISPLAY THE CALLER ID RECORDS

Make sure the station is on-hook and idle.

### ARE INTERCOM, LINE STATUS, AUTO-ANSWER, PRIVACY, OR AUTO-LINE SELECTION INOPERABLE?

1. Check if Lines 1 and 2 are cross-wired in the wall jack.

2. See if you may have installed your 2-line adapter incorrectly.
3. Be sure all NSQ412 stations in the system are connected to Line 1 and disconnect all non-system telephones from Line 1.
4. Check the station programmable codes.
5. Be sure the length of cable between stations does not exceed 600 feet.
6. Check that all phone lines are correctly connected to each station (every Line 1 is connected to the appropriate CO line, every Line 2 is connected to the appropriate CO line, and so on).
7. Remove all RFI filters from the system wiring, you may also need to contact your telephone company to have any RFI filters removed from the company side of the connection.

### IS YOUR TELEPHONE INOPERABLE?

1. Check all connections to be sure they are securely in place.
2. Reinitialize the telephone by momentarily unplugging the a. c. adapter.
3. Make sure the a. c. adapter has power at the wall outlet.

### **CAN'T HEAR THE RING SIGNAL ON ALL LINES**

1. Check the ringer volume controls.
2. Check the status of DND (Do Not Disturb).
3. Check to see if the Delayed Ring is set to a time instead of Off.
4. Check ringer programming to make sure the ringers are turned on.

### **CAN'T HEAR THE RING SIGNAL ON ONE LINE ONLY**

1. If this occurs on one station only, check the volume control setting on the station.
2. If all phones are affected, check the line connections.
3. Check ringer programming to make sure the ringers are turned on.

### **WHILE ON A CALL, DO YOU HEAR ANOTHER CALL ON THE LINE OR ARE YOU EXPERIENCING RADIO FREQUENCY INTERFERENCE?**

1. Make sure all wiring is twisted pair, including modular cords on non-system devices.
2. Check the wiring for bad connections.

### **CAN'T HEAR WHEN USING THE SPEAKERPHONE**

1. Adjust the speaker volume control.
2. Move the station to a quieter location.

### **REACHING THE WRONG NUMBER IN SPEED DIALING?**

1. Check that you are accessing the correct location.
2. Check that the number in the location is correct.

### **NO CALLER ID DISPLAYED**

1. Make sure that you have subscribed to Caller ID and Call Waiting Caller ID from your telephone company.
2. Make sure the phone rings twice before answering the call.

### **SPEED DIALING OR DIRECTORY DIALING OR CALLER ID DIALING DOES NOT WORK CORRECTLY**

Make sure the Area Code Programming is set up correctly.

### **ONLY BASIC TELEPHONE FEATURES OPERATE**

Check the a. c. adapter for correct operation and power.

### **CANNOT CONFERENCE TWO LINES**

Make sure you are connected to one call and have the other on hold before pressing the [CONF] key.

### **HANDSET FALLS OUT OF THE CRADLE ON THE WALL**

Make sure the handset hanger is in the wall mounting position.

### **CANNOT TRANSFER A CALL TO ANOTHER STATION**

1. Make sure that the other station has the same telephone line connected to it.
2. Make sure Line 1 is common on all stations.

### **CANNOT MAKE AN INTERCOM CALL OR PAGE**

1. Make sure the intercom path is not busy.
2. Make sure Line 1 is common on all stations.

### **(AUTO)REDIAL STOPS WORKING UNEXPECTEDLY**

1. Make sure that the line the call was placed on is not in use.
2. Using any feature beside the volume controls will cancel (Auto)Redial.

## LIMITED WARRANTY

This unit is warranted to the original purchaser to be free from defects in materials and workmanship under normal installation, use and service for a period of one (1) year from the date of purchase as shown on the purchaser's receipt.

The obligation of International Resources, Inc. under this warranty shall be limited to repair or replacement (at our option), during the warranty period, of any part which proves defective in material or workmanship under normal installation, use and service, provided the product is returned to International Resources, Inc. (address below) or to one of our authorized Service Centers, **TRANSPORTATION CHARGES PRE-PAID.** Products returned to us or to an authorized Service Center must be accompanied by a copy of the purchase receipt. In the absence of such purchase receipt, the warranty period shall be one (1) year from the date of manufacture.

This warranty shall be invalid if the product is damaged as a result of defacement, misuse, abuse, neglect, accident,

destruction or alteration of the serial number, improper electrical voltages or currents, repair, alteration or maintenance by any person or party other than our own service facility or an authorized Service Center, or any use violative of instructions furnished by us.

This warranty is also rendered invalid if this product is removed from the country in which it was purchased. If is used in a country in which it is not registered for use, and/or if it is used in a country for which it was not designed. Due to variations in telephone systems and communications laws, this product may be illegal for use in some countries. International Resources, Inc. assumes no responsibility for damages or penalties incurred resulting from the use of this product in a manner or location other than that for which it is intended.

This one-year warranty is in lieu of all other expressed warranties, obligations, or liabilities, **ANY IMPLIED WARRANTIES, OBLIGATIONS, OR LIABILITIES, INCLUDING BUT NOT LIMITED TO THE IMPLIED WARRANTIES OF MERCHANTABILITY AND FITNESS**

**FOR A PARTICULAR PURPOSE, SHALL BE LIMITED IN DURATION TO THE ONE-YEAR DURATION OF THIS WRITTEN LIMITED WARRANTY.** Some states do not allow limitations on how long an implied warranty lasts, so the above limitations may not apply to you.

**IN NO EVENT SHALL WE BE LIABLE FOR ANY SPECIAL, INCIDENTAL OR CONSEQUENTIAL DAMAGES FOR BREACH OF THIS OR ANY OTHER WARRANTY, EXPRESSED OR IMPLIED, WHATSOEVER.**

Some states do not allow the exclusion or limitation of special, incidental or consequential damages, so the above limitation or exclusion may not apply to you.

This warranty gives you specific legal rights, and you may also have other rights which vary from state to state.

**INTERNATIONAL RESOURCES, INC.**  
9325 Uptown Drive, Suite 900  
Indianapolis, IN 46256



**PLACE THIS TEMPLATE ON THE WALL**

THE LOCATION OF THE SCREWS IS INDICATED  
BY THE CENTERS OF THE CROSSED LINES.

FASTEN THE SCREWS LEAVING 3/16" OF THE SCREW  
EXTENDING FROM THE WALL

101 MM

**REMOVE THIS PAGE**







## Free Manuals Download Website

<http://myh66.com>

<http://usermanuals.us>

<http://www.somanuals.com>

<http://www.4manuals.cc>

<http://www.manual-lib.com>

<http://www.404manual.com>

<http://www.luxmanual.com>

<http://aubethermostatmanual.com>

Golf course search by state

<http://golfingnear.com>

Email search by domain

<http://emailbydomain.com>

Auto manuals search

<http://auto.somanuals.com>

TV manuals search

<http://tv.somanuals.com>