

INDOOR UNIT

SERVICE MANUAL

No. OBH501

**Wireless type
Models**

**MSZ-D30NA
MSZ-D36NA
MSY-D30NA
MSY-D36NA**

**Outdoor unit service manual
MUZ-D•NA Series (OBH502)
MUY-D•NA Series (OBH502)**

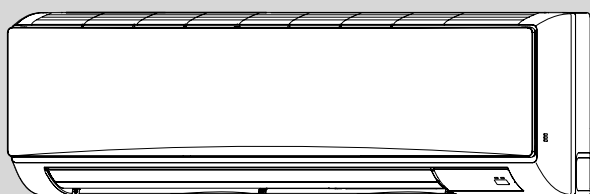

CONTENTS

1. TECHNICAL CHANGES.....	3
2. PART NAMES AND FUNCTIONS.....	4
3. SPECIFICATION.....	5
4. OUTLINES AND DIMENSIONS	7
5. WIRING DIAGRAM.....	8
6. REFRIGERANT SYSTEM DIAGRAM	9
7. SERVICE FUNCTIONS	10
8. MICROPROCESSOR CONTROL	12
9. TROUBLESHOOTING.....	19
10. DISASSEMBLY INSTRUCTIONS.....	31

PARTS CATALOG (OBB501)

NOTE:

RoHS compliant products have <G> mark on the spec name plate.

Mr. SLIM™

MSZ-D30NA
MSZ-D36NA
MSY-D30NA
MSY-D36NA

1. New model

2

PART NAMES AND FUNCTIONS

MSZ-D30NA
MSZ-D36NA
MSY-D30NA
MSY-D36NA

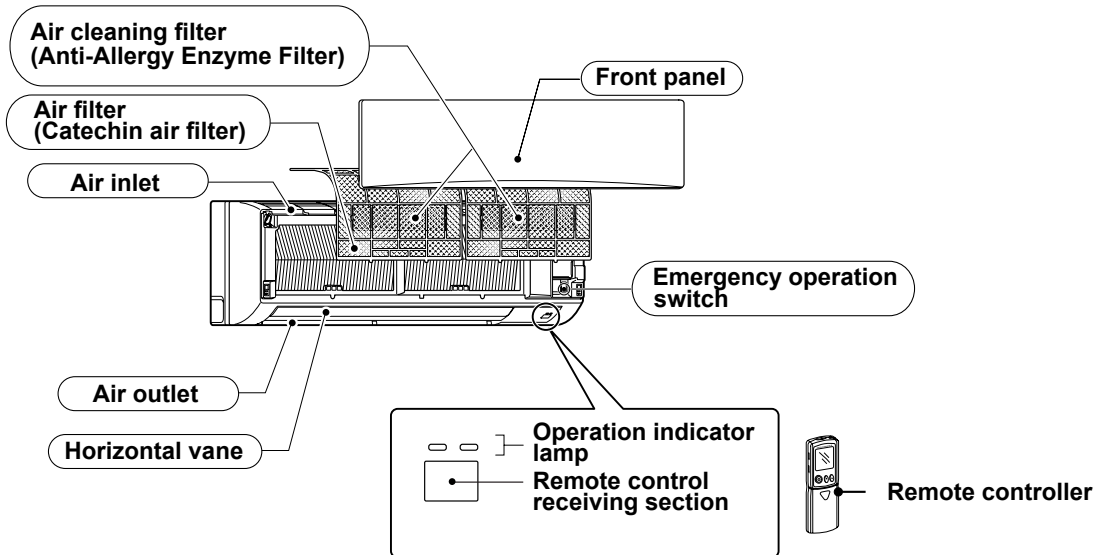

ACCESSORIES

	MSZ-D30NA MSZ-D36NA MSY-D30NA MSY-D36NA
① Installation plate	1
② Installation plate screw 4 × 25 mm	7
③ Remote controller holder	1
④ Screw for ③ × 3.5 × 1.6 mm (Black)	2
⑤ Battery (AAA) for remote controller	2
⑥ Wireless remote controller	1
⑦ Felt tape (Used for left or left-rear piping)	2
⑧ L-Joint pipe	1
⑨ Conduit plate	1
⑩ Air cleaning filter	2

3

SPECIFICATION

Model			MSZ-D30NA	MSY-D30NA	MSZ-D36NA	MSY-D36NA
External finish			White			
Power supply		V, phase, Hz	208 / 230 , 1 , 60			
Max. fuse size (time delay)/ Disconnect switch		A	15			
Min. circuit ampacity		A	1.0			
Fan motor		F.L.A	0.76			
Airflow Low-Med.-High	HEAT Dry	CFM	445-639-848	—	445-639-848	—
	COOL Dry (Wet)	CFM	389(350)-639(576)-848(763)		389(350)-639(576)-848(763)	
Moisture removal		pt./h	9.9		11.3	11.9
Sound level Low-Med.-High	Cooling	dB(A)	32-42-49	32-42-49	32-42-49	32-42-49
	Heating	dB(A)	34-42-49	—	34-42-49	—
Cond. drain connection O.D.		in.	5/8			
Dimensions	W	in.	46-1/16			
	D	in.	11-5/8			
	H	in.	14-3/8			
Weight		lb.	40			
Remote controller			Wireless type			
Control voltage (by built-in transformer)			12-24 VDC			

NOTE : Test conditions are based on ARI 210/240.

3-1. OPERATING RANGE

(1) POWER SUPPLY

	Rated voltage	Guaranteed Voltage
Indoor unit	208/230 V 1 phase 60 Hz	Min.187 V 208 V 230 V Max.253 V ----- ----- ----- ----- -----

(2) OPERATION

Mode	Condition	Intake air temperature (°F)			
		Indoor		Outdoor	
		DB	WB	DB	WB
Cooling	Standard temperature	80	67	95	—
	Maximum temperature	90	73	115	—
	Minimum temperature	67	57	14	—
	Maximum humidity	78 %		—	
Heating	Standard temperature	70	60	47	43
	Maximum temperature	80	67	75	65
	Minimum temperature	70	60	14	13

3-2. OUTLET AIR SPEED AND COVERAGE RANGE

Model	Mode	Function	Airflow (CFM)	Air speed (ft./sec.)	Coverage range (ft.)
MSZ-D30NA MSZ-D36NA	HEAT	Dry	848	23.6	45.0
MSZ-D30NA MSZ-D36NA MSY-D30NA MSY-D36NA	COOL	Dry	848	23.6	45.0
		Wet	763	21.3	40.7

- The air coverage range is the figure up to the position where the air speed is 1 ft./sec., when air is blown out horizontally from the unit properly at the High speed position. The coverage range should be used only as a general guideline since it varies according to the size of the room and furniture arranged inside the room.

4

OUTLINES AND DIMENSIONS

MSZ-D30NA
MSZ-D36NA
MSY-D30NA
MSY-D36NA

Unit : inch

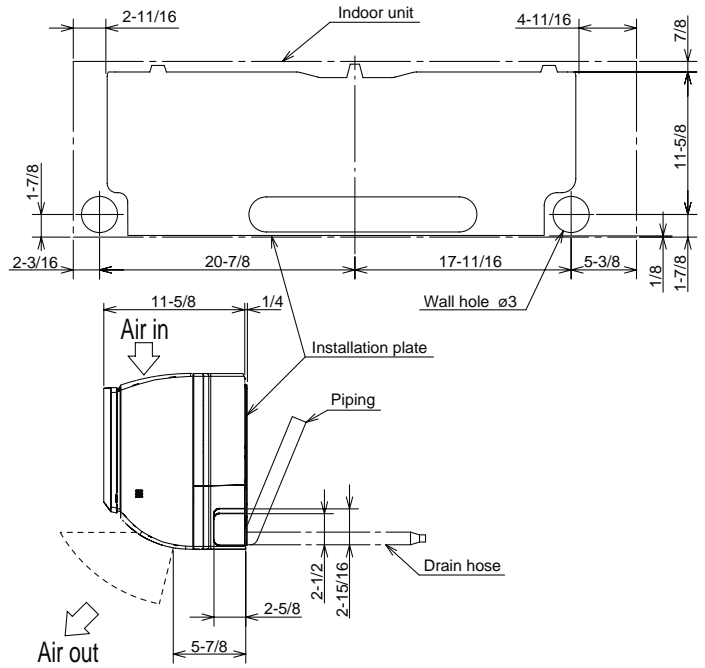
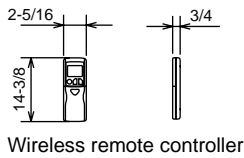
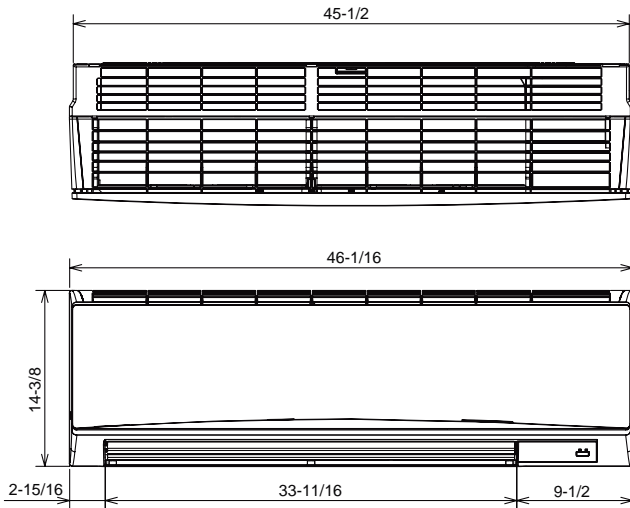

	Piping	Insulation
Liquid line	$\phi 3/8$ 19-11/16 (Flared connection $\phi 3/8$)	$\phi 1-1/4$ O.D $\phi 9/16$ I.D
Gas line	$\phi 5/8$ 16-7/8 (Joint connection $\phi 5/8$)	$\phi 1-15/16$ O.D $\phi 1-1/4$ I.D
Joint	$\phi 5/8$ (Flared connection $\phi 5/8$)	$\phi 1-15/16$ O.D $\phi 1-1/4$ I.D
Drain hose	Insulation $\phi 1-1/8$ Connected part $\phi 9/16$ O.D	

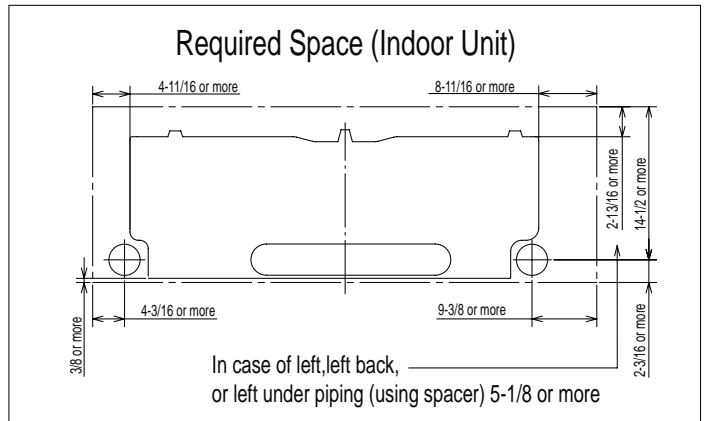

5

WIRING DIAGRAM

MSZ-D30NA
MSZ-D36NA
MSY-D30NA
MSY-D36NA

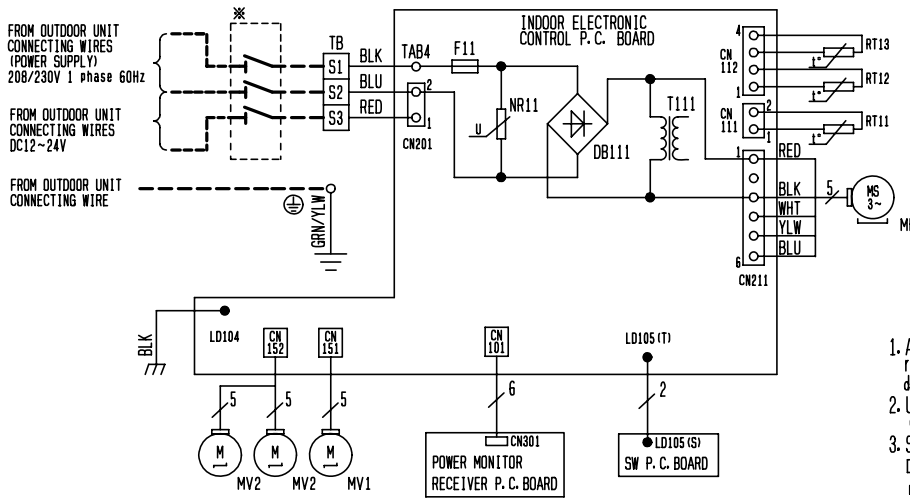

SYMBOL	NAME	SYMBOL	NAME
DB111	DIODE STACK	RT11	ROOM TEMP. THERMISTOR
F11	FUSE (T3-15A/250V)	RT12	COIL TEMP. THERMISTOR (MAIN)
MF	FAN MOTOR	RT13	COIL TEMP. THERMISTOR (SUB)
MV1	VANE MOTOR (HORIZONTAL)	T111	TRANSFORMER
MV2	VANE MOTOR (VERTICAL)	TB	TERMINAL BLOCK
NR11	VARISTOR		

1. About the outdoor side electric wiring refer to the outdoor unit electric wiring diagram for servicing.
2. Use copper conductors only. (For field wiring)
3. Symbols below indicate.
 : Terminal block
 : Connector

※ A disconnect should be required by local code.

6

REFRIGERANT SYSTEM DIAGRAM

MSZ-D30NA
 MSZ-D36NA
 MSY-D30NA
 MSY-D36NA

Unit:inch

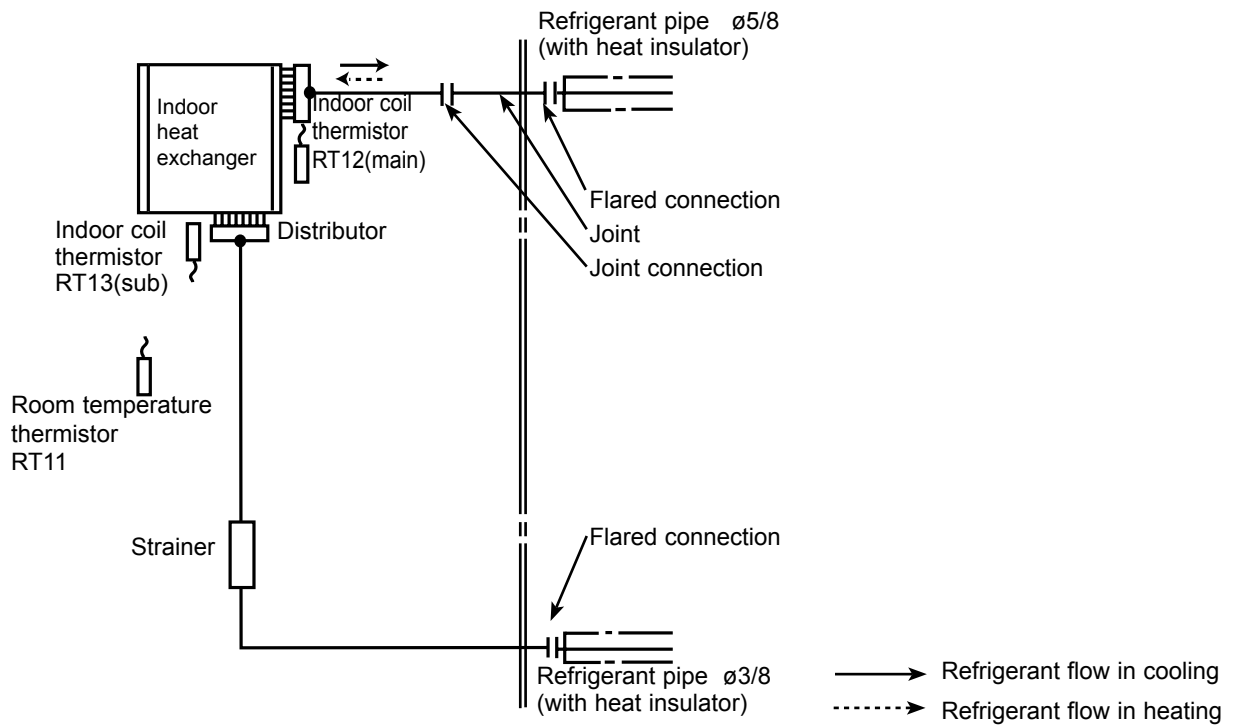

MSZ-D30NA**MSZ-D36NA****MSY-D30NA****MSY-D36NA****7-1. TIMER SHORT MODE**

For service, set time can be shortened by short circuit of JPG and JPS the indoor electronic control P.C. board.

The time will be shortened as follows. (Refer to 9-7.)

Set time : 1-minute → 1-second

Set time : 3-minute → 3-second (It takes 3 minutes for the compressor to start operation. However, the starting time is shortened by short circuit-of JPG and JPS.)

7-2. P.C. BOARD MODIFICATION FOR INDIVIDUAL OPERATION

A maximum of 4 indoor units with wireless remote controllers can be used in a room.

In this case, to operate each indoor unit individually by each remote controller, P.C. boards of remote controller must be modified according to the number of the indoor unit.

How to modify the remote controller P.C. board

Remove batteries before modification.

The board has a print as shown below :

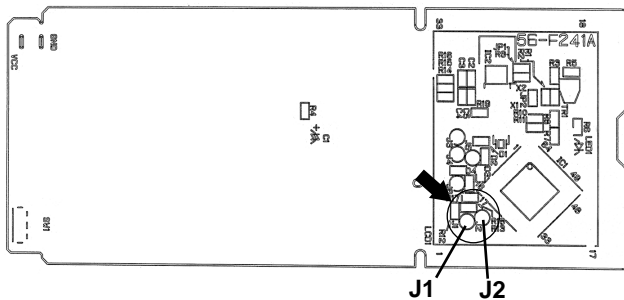

NOTE : For modification, take out the batteries and press the OPERATE/STOP (ON/OFF) button twice or 3 times at first. After finish modification, put back the batteries then press the RESET button.

The P.C. board has the print "J1" and "J2". Solder "J1" and "J2" according to the number of indoor unit as shown in Table 1. After modification, press the RESET button.

Table 1

	1 unit operation	2 units operation	3 units operation	4 units operation
No. 1 unit	No modification	Same as at left	Same as at left	Same as at left
No. 2 unit	—	Solder J1	Same as at left	Same as at left
No. 3 unit	—	—	Solder J2	Same as at left
No. 4 unit	—	—	—	Solder both J1 and J2

How to set the remote controller exclusively for particular indoor unit

After you turn the breaker ON, the first remote controller that sends the signal to the indoor unit will be regarded as the remote controller for the indoor unit.

The indoor unit will only accept the signal from the remote controller that has been assigned to the indoor unit once they are set.

The setting will be cancelled if the breaker has turned off, or the power supply has shut down.

Please conduct the above setting once again after the power has restored.

7-3. AUTO RESTART FUNCTION

When the indoor unit is controlled with the remote controller, the operation mode, the set temperature, and the fan speed are memorized by the indoor electronic control P.C. board. The "AUTO RESTART FUNCTION" sets to work the moment power has restored after power failure. Then, the unit will restart automatically.

Operation

- ① If the main power has been cut, the operation settings remain.
- ② After the power is restored, the unit restarts automatically according to the memory.
(However, it takes at least 3 minutes for the compressor to start running.)

How to release "AUTO RESTART FUNCTION"

- ① Turn off the main power of the unit.
- ② Solder the Jumper wire JR07 on the indoor electronic control P.C. board. (Refer to 9-7.)

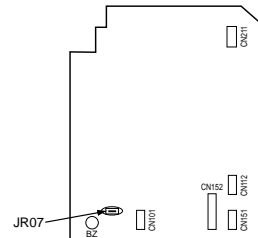

NOTE:

- The operation settings are memorized when 10 seconds have passed after the indoor unit was operated with the remote controller.
- If main power is turned OFF or a power failure occurs while AUTO START/STOP timer is active, the timer setting is cancelled.
- If the unit has been off with the remote controller before power failure, the auto restart function does not work as the power button of the remote controller is off.
- To prevent breaker off due to the rush of starting current, systematize other home appliance not to turn on at the same time.
- When some air conditioners are connected to the same supply system, if they are operated before power failure, the starting current of all the compressors may flow simultaneously at restart. Therefore, the special counter-measures are required to prevent the main voltage-drop or the rush of the starting current by adding to the system that allows the units to start one by one.

MSZ-D30NA
MSZ-D36NA
MSY-D30NA
MSY-D36NA

WIRELESS REMOTE CONTROLLER

※ These pictures show **MSZ** type.

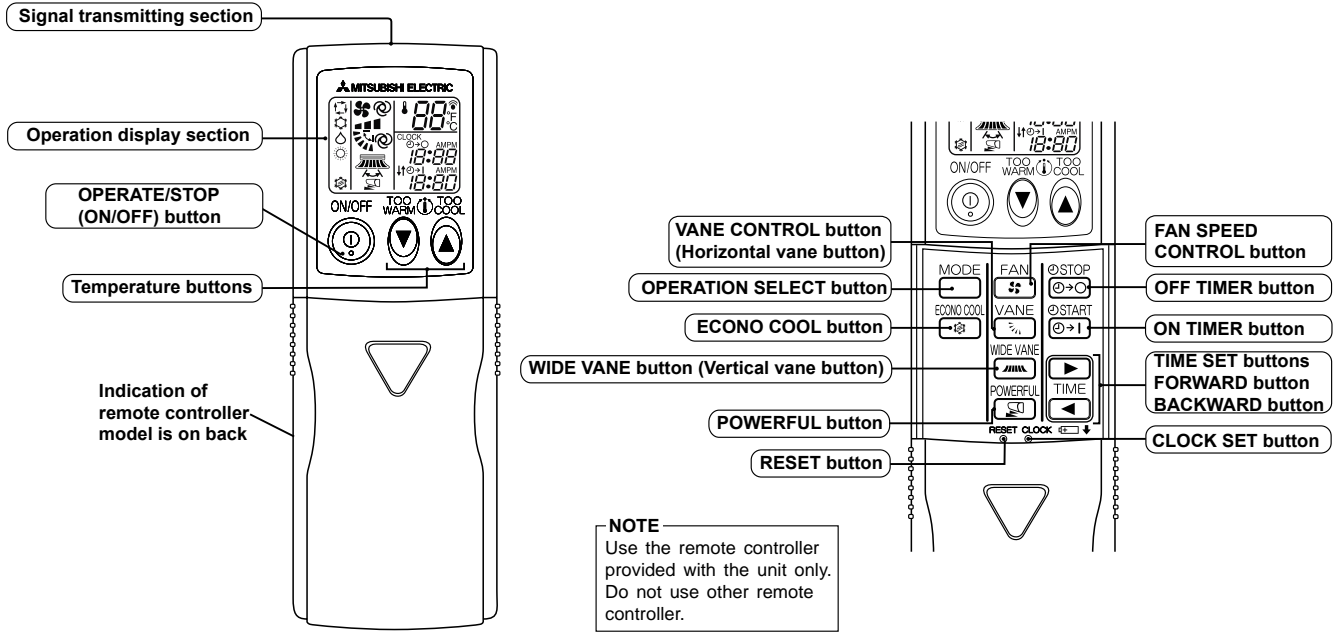

NOTE: Last setting will be stored after the unit is turned OFF with the remote controller. Indoor unit receives the signal of the remote controller with beeps.

INDOOR UNIT DISPLAY SECTION

Operation Indicator lamp

The operation indicator at the right side of the indoor unit indicates the operation state.

•The following indication applies regardless of shape of shape of the indication.

Indication	Operation state	Room temperature
● ●	The unit is operating to reach the set temperature	About 4 °F (2 °C) or more away from set temperature
● ◐	The room temperature is approaching the set temperature	About 2 °F (1 °C) to 4 °F (2 °C) from set temperature

- Lighted
- ◐ Blinking
- Not lighted

8-1. COOL (❄) OPERATION

- (1) Press OPERATE/STOP (ON/OFF) button.
OPERATION INDICATOR lamp of the indoor unit turns on with a beep tone.
- (2) Select COOL mode with OPERATION SELECT button.
- (3) Press TEMPERATURE buttons (TOO WARM or TOO COOL button) to select the desired temperature.
The setting range is 61 ~ 88 °F (16 ~ 31 °C).

1. Coil frost prevention

When the temperature of indoor heat exchanger becomes too low, the coil frost prevention mode works.
The indoor fan operates at the set speed and the compressor stops. This mode continues until the temperature of indoor heat exchanger rises.

2. Low outside temperature operation

When the outside temperature is lower, low outside temperature operation starts, and the outdoor fan slows or stops.

8-2. DRY (☀) OPERATION

- (1) Press OPERATE/STOP (ON/OFF) button.
OPERATION INDICATOR lamp of the indoor unit turns on with a beep tone.
- (2) Select DRY mode with OPERATION SELECT button.
- (3) The set temperature is determined from the initial room temperature.

1. Coil frost prevention

Coil frost prevention is as same as COOL mode. (8-1.1.)

2. Low outside temperature operation

Low outside temperature operation is as same as COOL mode. (8-1.2.)

8-3. HEAT (🔥) OPERATION (MSZ)

- (1) Press OPERATE/STOP (ON/OFF) button.
OPERATION INDICATOR lamp of the indoor unit turns on with a beep tone.
- (2) Select HEAT mode with OPERATION SELECT button.
- (3) Press TEMPERATURE buttons (TOO WARM or TOO COOL button) to select the desired temperature.
The setting range is 61 ~ 88 °F (16 ~ 31 °C).

1. Cold air prevention control

When the compressor is not operating or is starting, and the temperature of indoor heat exchanger and/or the room temperature is low or when defrosting is being done, the indoor fan will stop or rotate in Very Low speed.

2. High pressure protection

The compressor operational frequency is controlled by the temperature of the indoor heat exchanger to prevent the condensing pressure from increasing excessively.

When the temperature of indoor heat exchanger becomes too high, the high pressure protection works.

The indoor fan operates following the cold air prevention control. This mode continues until the temperature of indoor heat exchanger falls.

3. Defrosting

Defrosting starts when the temperature of outdoor heat exchanger becomes too low.

The compressor stops once, the indoor/outdoor fans stop, the 4-way valve reverses and the compressor re-starts.

This mode continues until the temperature of outdoor heat exchanger rises or the fixed time passes.

8-4. FAN(🌀) OPERATION (MSY)

- (1) Press OPERATE/STOP (ON/OFF) button.
OPERATION INDICATOR lamp of the indoor unit turns ON with a beep tone.
- (2) Select FAN mode with OPERATION SELECT button.
- (3) Select the desired fan speed. When AUTO, it becomes Low.
Only indoor fan operates. Outdoor unit does not operate.

8-5. "I FEEL CONTROL" (🏠) OPERATION (MSY)

- (1) Press OPERATE/STOP (ON/OFF) button on the remote controller. OPERATION INDICATOR lamp of the indoor unit turns on with a beep tone.
- (2) Select "I FEEL CONTROL" mode with OPERATION SELECT button.
- (3) The operation mode is determined by the room temperature at start-up of the operation.

Initial room temperature	Mode
77 °F (25 °C) or more	COOL mode of "I FEEL CONTROL"
more than 55 °F (13 °C), less than 77 °F (25 °C)	DRY mode of "I FEEL CONTROL"

- Once the mode is fixed, the mode does not change by room temperature afterwards.
- Under the ON TIMER (⌚) operation, mode is determined according to the room temperature at the set time the operation starts.

(4) The initial set temperature is decided by the initial room temperature.

Model	Initial room temperature	Initial set temperature	
COOL mode of "I FEEL CONTROL"	79 °F (26 °C) or more	75°F (24 °C)	*1
	77 °F (25 °C) to 79 °F (26 °C)	Initial room temperature minus 4 °F (2 °C)	
DRY mode of "I FEEL CONTROL"	more than 55 °F (13 °C), less than 77 °F (25 °C)	Initial room temperature minus 4 °F (2 °C)	

*1 When the system is restarted with the remote controller, the system operates with the previous set temperature regardless of room temperature at restart.

The set temperature is calculated by the previous set temperature.

(5) TEMPERATURE buttons

In "I FEEL CONTROL" () mode, set temperature is decided by the microprocessor based on the room temperature. In addition, set temperature can be controlled by TOO WARM or TOO COOL buttons when you feel too cool or too warm.

Each time the TOO WARM or TOO COOL button is pressed, the indoor unit receives the signal and emits a beep tone.

• **Fuzzy control**

When the TOO COOL or TOO WARM button is pressed, the microprocessor changes the set temperature, considering the room temperature, the frequency of pressing TOO COOL or TOO WARM button and the user's preference to heat or cool. So this is called "Fuzzy control", and works only in "I FEEL CONTROL" mode.

In DRY mode of "I FEEL CONTROL", the set temperature doesn't change.

TOO COOL



... To raise the set temperature 2 ~ 4 °F (1 ~ 2 °C)

TOO WARM



... To lower the set temperature 2 ~ 4 °F (1 ~ 2 °C)

8-6. AUTO CHANGE OVER ... AUTO MODE OPERATION (MSZ)

Once desired temperature is set, unit operation is switched automatically between COOL and HEAT operation.

Mode selection

(1) Initial mode

When unit starts the operation with AUTO operation from off;

- If the room temperature is higher than the set temperature, operation starts in COOL mode.
- If the room temperature is equal to or lower than the set temperature, operation starts in HEAT mode.

(2) Mode change

COOL mode changes to HEAT mode when about 15 minutes have passed with the room temperature 4 °F (2 °C) below the set temperature.

HEAT mode changes to COOL mode when about 15 minutes have passed with the room temperature 4 °F (2 °C) above the set temperature.

8-7. AUTO VANE OPERATION

1. Horizontal vane

(1) Vane motor drive

These models are equipped with a stepping motor for the horizontal vane. The rotating direction, speed, and angle of the motor are controlled by pulse signals (approx. 12 V) transmitted from indoor microprocessor.

(2) The horizontal vane angle and mode change as follows by pressing VANE CONTROL button.

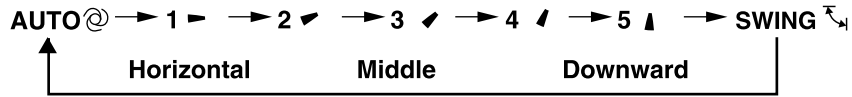

(3) Positioning

To confirm the standard position, the vane moves until it touches the vane stopper. Then the vane is set to the selected angle.

(a) The operation starts or finishes (including timer operation).

(b) The test run starts.

(4) VANE AUTO (⊙) mode

The microprocessor automatically determines the horizontal vane angle and operation to make the optimum room temperature distribution.

COOL and DRY operation

FAN operation (**MSY**)

Vane angle is fixed to Angle 1.

HEAT operation (**MSZ**)

Vane angle is fixed to Angle 4.

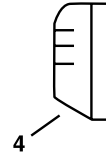
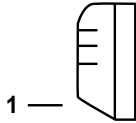

(5) STOP (operation OFF) and ON TIMER standby

In the following cases, the horizontal vane returns to the closed position.

(a) OPERATE/STOP (ON/OFF) button is pressed (POWER OFF).

(b) The operation is stopped by the emergency operation.

(c) ON TIMER is ON standby.

(6) Dew prevention

During COOL or DRY operation with the vane angle at Angle 4 ~ 5 when the compressor cumulative operation time exceeds 1 hour, the vane angle automatically changes to Angle 1 for dew prevention.

(7) SWING (↻) mode

By selecting SWING mode with VANE CONTROL button, the horizontal vane swings vertically.

(8) Cold air prevention in HEAT operation (**MSZ**)

The horizontal vane position is set to Upward.

(9) ECONO COOL (⚙) operation (ECONOmical operation)

When ECONO COOL button is pressed in COOL mode, set temperature is automatically set 3.6 °F (2 °C) higher.

Also the horizontal vane swings in various cycle.

SWING operation makes you feel cooler than set temperature. So, even though the set temperature is higher, the air conditioner can keep comfort. As a result, energy can be saved.

ECONO COOL operation is cancelled when ECONO COOL button is pressed once again, when the VANE CONTROL or POWERFUL button is pressed, or operation mode is changed.

(10) POWERFUL (⚡) operation.

The air conditioner automatically adjusts the fan speed and the set temperature, and operates the POWERFUL mode.

The POWERFUL mode is cancelled automatically 15 minutes after operation starts, or when POWERFUL button is pressed once again within 15 minutes after operation starts.

The operation mode returns to the mode prior to POWERFUL operation. POWERFUL mode also is cancelled, when the ECONO COOL or FAN SPEED SELECT button is pressed within 15 minutes after operation starts, or operation mode is changed.

2. Vertical vane

(1) Vane motor drive

These models are equipped with a stepping motor for the vertical vane. The rotating direction, speed, and angle of the motor are controlled by pulse signals (approx. 12 V) transmitted from microprocessor.

(2) The vertical vane angle and mode change as follows by pressing WIDE VANE button.

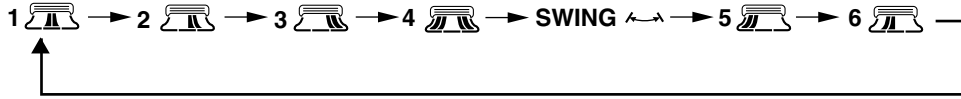

(3) Positioning

The vane is once pressed to the vane stopper to confirm the standard position and then set to the desired angle. Confirming of standard position is performed in the following cases.

- (a) OPERATE/STOP (ON/OFF) button is pressed (POWER ON/OFF).
- (b) SWING is started or finished.
- (c) The power supply turns ON.

(4) SWING MODE (↔)

By selecting SWING mode with WIDE VANE button, the vertical vane swings horizontally. The remote controller displays "↔".

(5) WIDE MODE (⚡)

By selecting WIDE mode with WIDE VANE button, indoor fan speed becomes faster than setting fan speed on the remote controller (⚡). The remote controller displays "⚡".

NOTE : The position of vane angle 3, angle 4 and angle 5 are different in COOL operation and HEAT operation.

- ※ Indoor fan speed becomes faster than setting fan speed on the remote controller even when ⚡ or ⚡ is selected.

8-8. TIMER OPERATION

1. How to set the time



(1) Check that the current time is set correctly.

NOTE : Timer operation will not work without setting the current time. Initially "0:00" blinks at the current time display of TIME MONITOR, so set the current time correctly with CLOCK SET button.

How to set the current time

(a) Press the CLOCK set button.

(b) Press the TIME SET buttons ( and ) to set the current time.

- Each time FORWARD button () is pressed, the set time increases by 1 minute, and each time BACKWARD button () is pressed, the set time decreases by 1 minute.

- Pressing those buttons longer, the set time increases / decreases by 10 minutes.

(c) Press the CLOCK set button.

(2) Press OPERATE/STOP (ON/OFF) button to start the air conditioner.

(3) Set the time of timer.



ON timer setting



(a) Press ON TIMER button () during operation.

(b) Set the time of the timer using TIME SET buttons ( and ) . ※

OFF timer setting

(a) Press OFF TIMER button () during operation.

(b) Set the time of the timer using TIME SET buttons ( and ) . ※

- ※ Each time FORWARD button () is pressed, the set time increases by 10 minutes; each time BACKWARD button () is pressed, the set time decreases by 10 minutes.

2. To release the timer

To release ON timer, press ON TIMER button ().

To release OFF timer, press OFF TIMER button ().

TIMER is cancelled and the display of set time disappears.

PROGRAM TIMER

• OFF timer and ON timer can be used in combination. The timer of the set time that is reached first will operate first.

• "↓" and "↑" display shows the order of OFF timer and ON timer operation.

(Example 1) The current time is 8:00 PM.

The unit turns off at 11:00 PM, and on at 6:00 AM.

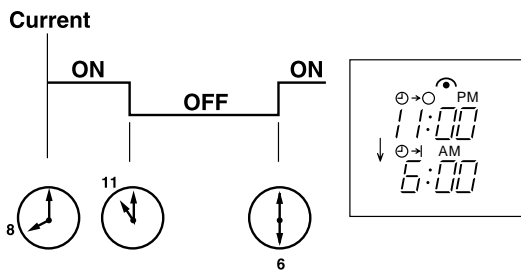

(Example 2) The current time is 11:00 AM.

The unit turns on at 5:00 PM, and off at 9:00 PM.

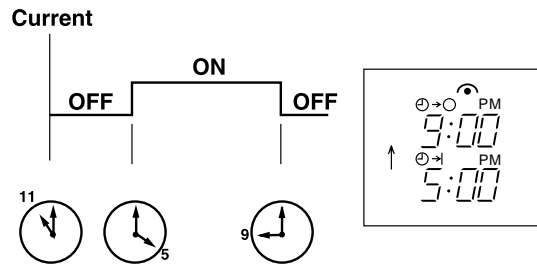

NOTE : If the main power is turned OFF or a power failure occurs while ON/OFF timer is active, the timer setting is cancelled. As these models are equipped with an auto restart function, the air conditioner starts operating with timer cancelled when power is restored.

8-9. EMERGENCY/TEST OPERATION

In case of test run operation or emergency operation, use EMERGENCY OPERATION switch on the front of the indoor unit. Emergency operation is available when the remote controller is missing, has failed or the batteries of the remote controller run down. The unit will start and OPERATION INDICATOR lamp will light.

The first 30 minutes of operation is the test run operation. This operation is for servicing. The Indoor fan speed runs at High speed and the system is in continuous operation (with thermostat ON).

After 30 minutes of test run operation the system shifts to EMERGENCY COOL / HEAT MODE with a set temperature of 75 °F (24 °C). The fan speed shifts to Med.

All protective operations such as the coil frost prevention works even in emergency operation.

In the test run or emergency operation, the horizontal vane operates in VANE AUTO () mode.

Emergency operation continues until EMERGENCY OPERATION switch is pressed once or twice or the unit receives any signal from the remote controller. In case of latter normal operation will start.

NOTE : Do not press EMERGENCY OPERATION switch during normal operation.

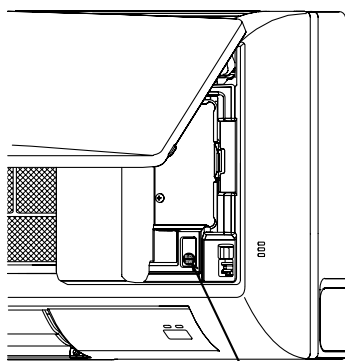

EMERGENCY OPERATION switch



Operation mode	COOL	HEAT (MUZ)
Set temperature	75 °F (24 °C)	75 °F (24 °C)
Fan speed	Med.	Med.
Horizontal vane	Auto	Auto

The operation mode is indicated by the Operation Indicator lamp as following

Operation Indicator lamp

(MSZ type)

EMERGENCY COOL  



EMERGENCY HEAT  



STOP  





(MSY type)

EMERGENCY COOL  



STOP  



 Lighted
 Not lighted

8-10. 3-MINUTE TIME DELAY OPERATION

When the system turns OFF, compressor will not restart for 3 minutes as 3-minute time delay function operates to protect compressor from overload.

8-11. CHANGING TEMPERATURE INDICATION (°F /°C)

- The preset unit is °F.
- °F→°C : Press RESET button while the temperature buttons are pressed.
- °C→°F : Press RESET button or remove the batteries .

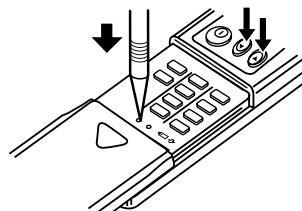

Press RESET button gently using a thin stick.

MSZ-D30NA**MSZ-D36NA****MSY-D30NA****MSY-D36NA****9-1. CAUTIONS ON TROUBLESHOOTING****1. Before troubleshooting, check the following**

- 1) Check the power supply voltage.
- 2) Check the indoor/outdoor connecting wire for miswiring.

2. Take care of the following during servicing

- 1) Before servicing the air conditioner, be sure to turn off the unit first with the remote controller, and then after confirming the horizontal vane is closed, turn off the breaker and / or disconnect the power plug.
- 2) Be sure to turn OFF the power supply before removing the front panel, the cabinet, the top panel, and the electronic control P.C. board.
- 3) When removing the electronic control P.C. board, hold the edge of the board with care NOT to apply stress on the components.
- 4) When connecting or disconnecting the connectors, hold the housing of the connector. DO NOT pull the lead wires.

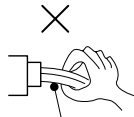
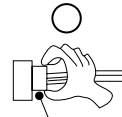
**Lead wiring****Housing point****3. Troubleshooting procedure**

- 1) First, check if the OPERATION INDICATOR lamp on the indoor unit is flashing on and off to indicate an abnormality. To make sure, check how many times the abnormality indication is flashing on and off before starting service work.
- 2) Before servicing check that the connector and terminal are connected properly.
- 3) If the electronic control P.C. board is supposed to be defective, check the copper foil pattern for disconnection and the components for bursting and discoloration.
- 4) When troubleshooting, refer to 9-2., 9-3. and 9-4.

4. How to replace batteries

Weak batteries may cause the remote controller malfunction.

In this case, replace the batteries to operate the remote controller normally.

- ① Remove the front lid and insert batteries. Then reattach the front lid.

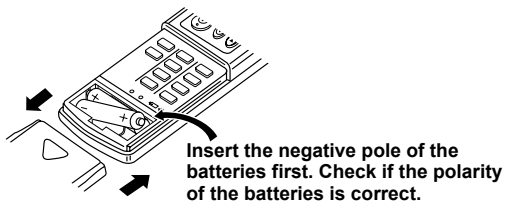

- ② Press RESET button with tip end of ball point pen or the like, and then use the remote controller.

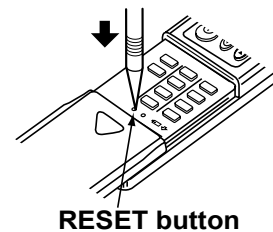

NOTE : 1. If RESET button is not pressed, the remote controller may not operate correctly.

2. This remote controller has a circuit to automatically reset the microcomputer when batteries are replaced. This function is equipped to prevent the microcomputer from malfunctioning due to the voltage drop caused by the battery replacement.

9-2. FAILURE MODE RECALL FUNCTION

Outline of the function

This air conditioner can memorize the abnormal condition which has occurred once.

Even though LED indication listed on the troubleshooting check table (9-4.) disappears, the memorized failure details can be recalled.

This mode is very useful when the unit needs to be repaired for the abnormality which doesn't recur.

1. Flow chart of failure mode recall function for the indoor/outdoor unit

Operational procedure

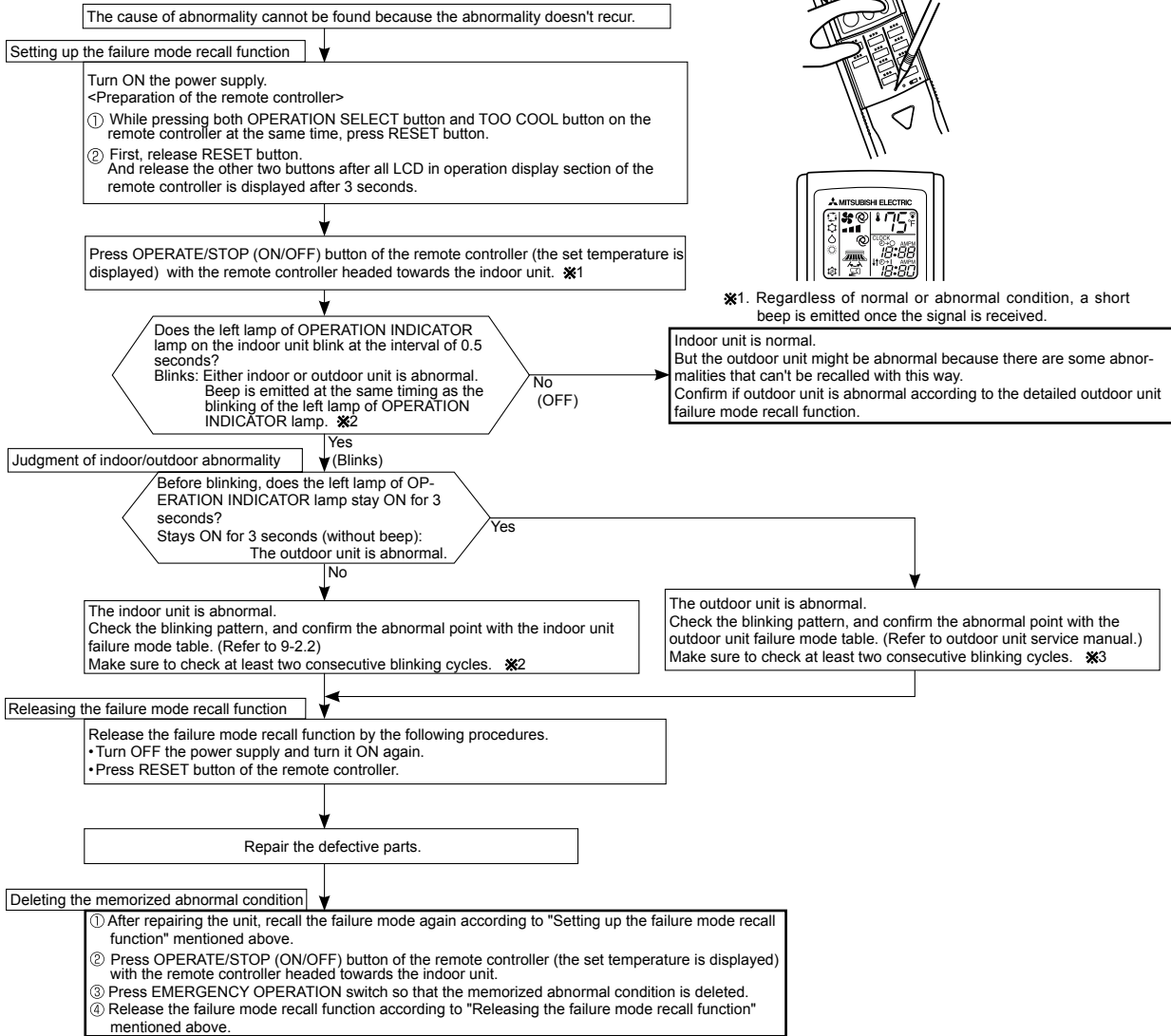

NOTE: 1. Make sure to release the failure mode recall function once it's set up, otherwise the unit cannot operate properly.
 2. If the abnormal condition is not deleted from the memory, the last abnormal condition is kept memorized.

※2. Blinking pattern when the indoor unit is abnormal:

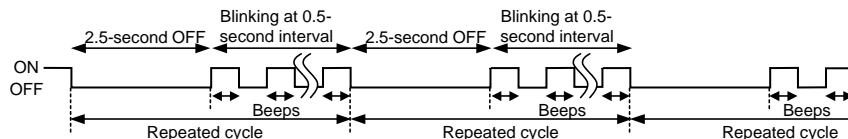

※3. Blinking pattern when the outdoor unit is abnormal:

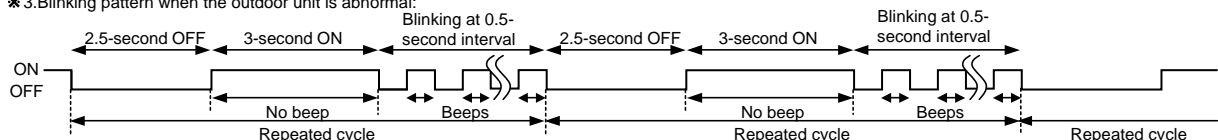

2. Indoor unit failure mode table

Left lamp of OPERATION INDICATOR lamp	Abnormal point (Failure mode)	Condition	Correspondence
Not lighted	Normal	—	—
1-time flash every 0.5-second	Room temperature thermistor	The room temperature thermistor short or open circuit is detected every 8 seconds during operation.	Refer to the characteristics of the room temperature thermistor (9-7.).
2-time flash 2.5-second OFF	Indoor coil thermistor	The indoor coil thermistor short or open circuit is detected every 8 seconds during operation.	Refer to the characteristics of the main indoor coil thermistor, the sub indoor coil thermistor (9-7.).
3-time flash 2.5-second OFF	Serial signal	The serial signal from outdoor unit is not received for a maximum of 6 minutes.	Refer to 9-6.Ⓓ "How to check miswiring and serial signal error".
11-time flash 2.5-second OFF	Indoor fan motor	The rotational frequency feedback signal is not emit during the 12 seconds the indoor fan operation.	Refer to 9-6.Ⓐ "Check of indoor fan motor".
12-time flash 2.5-second OFF	Indoor control system	It cannot properly read data in the nonvolatile memory of the indoor electronic control P.C. board.	Replace the indoor electronic control P.C. board.

NOTE : Blinking patterns of this mode differ from the ones of Troubleshooting check table (9-4.).

9-3. INSTRUCTION OF TROUBLESHOOTING

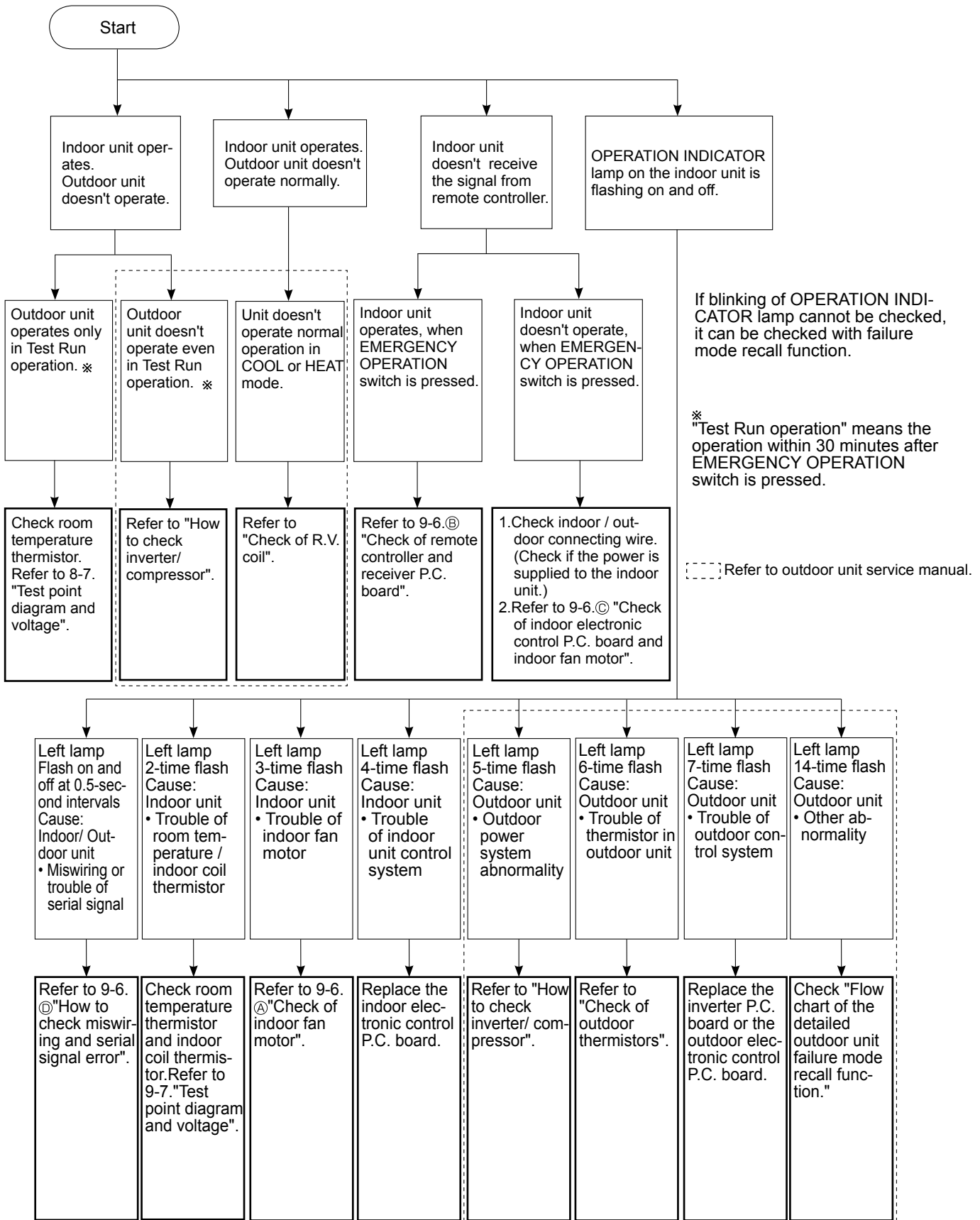

9-4. TROUBLESHOOTING CHECK TABLE

Before taking measures, make sure that the symptom reappears for accurate troubleshooting.
 When the indoor unit has started operation and the following detection method has detected an abnormality (the first detection after the power ON), the indoor electronic control P.C. board turns OFF the indoor fan motor with OPERATION INDICATOR lamp flashing.

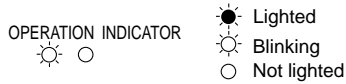

No.	Abnormal point	Operation indicator lamp	Symptom	Condition	Correspondence
1	Miswiring or serial signal	Left lamp flashes. 0.5-second ON 0.5-second OFF	Indoor unit and outdoor unit do not operate.	The serial signal from the outdoor unit is not received for a maximum of 6 minutes.	• Refer to 9-6.Ⓒ "How to check miswiring and serial signal error".
2	Indoor coil thermistor Room temperature thermistor	Left lamp flashes. 2-time flash 2.5-second OFF	Indoor unit and outdoor unit do not operate.	The indoor coil or the room temperature thermistor is short or open circuit.	• Refer to 9-7.the characteristics of indoor coil thermistor, and the room temperature thermistor.
3	Indoor fan motor	Left lamp flashes. 3-time flash 2.5-second OFF	Indoor unit and outdoor unit do not operate.	The rotational frequency feedback signal is not emitted during the indoor fan operation.	• Refer to 9-6.Ⓐ "Check of indoor fan motor".
4	Indoor control system	Left lamp flashes. 4-time flash 2.5-second OFF	Indoor unit and outdoor unit do not operate.	It cannot properly read data in the nonvolatile memory of the indoor electronic control P.C. board.	• Replace the indoor electronic control P.C. board.
5	Outdoor power system	Left lamp flashes. 5-time flash 2.5-second OFF	Indoor unit and outdoor unit do not operate.	It consecutively occurs 3 times that the compressor stops for overcurrent protection or start-up failure protection within 1 minute after start-up.	• Refer to "How to check of inverter/compressor". Refer to outdoor unit service manual. • Check the stop valve.
6	Outdoor thermistors	Left lamp flashes. 6-time flash 2.5-second OFF	Indoor unit and outdoor unit do not operate.	The outdoor thermistors short or open circuit during the compressor operation.	• Refer to "Check of outdoor thermistor". Refer to outdoor unit service manual.
7	Outdoor control system	Left lamp flashes. 7-time flash 2.5-second OFF	Indoor unit and outdoor unit do not operate.	It cannot properly read data in the nonvolatile memory of the inverter P.C. board or the outdoor electronic control P.C. board.	• Replace the inverter P.C. board or the outdoor electronic control P.C. board. Refer to outdoor unit service manual.
8	Other abnormality	Left lamp flashes. 14-time flash 2.5-second OFF	Indoor unit and outdoor unit do not operate.	An abnormality other than above mentioned is detected.	• Confirm the abnormality in detail using the failure mode recall function for outdoor unit.

9-5. TROUBLE CRITERION OF MAIN PARTS

MSZ-D30NA

MSZ-D36NA

MSY-D30NA

MSY-D36NA

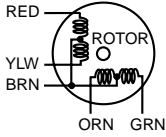
Part name	Check method and criterion	Figure							
Room temperature thermistor(RT11) Indoor coil thermistor (RT12(MAIN), RT13(SUB))	Measure the resistance with a tester. Refer to 9-7. "Test point diagram and voltage", "Indoor electronic control P.C. board", the chart of thermistor.								
Indoor fan motor(MF)	Check 9-6. ㉠.								
Horizontal vane motor (MV1) Vertical vane motor (MV2)	Measure the resistance between the terminals with a tester. (Part temperature 50 ~ 86 °F) Horizontal vane motor (MV1) <table border="1" data-bbox="387 778 845 846"> <tr> <td>Color of the lead wire</td> <td>Normal</td> </tr> <tr> <td>BRN - other one</td> <td>240 ~ 260 Ω</td> </tr> </table> Vertical vane motor (MV2) <table border="1" data-bbox="387 885 845 953"> <tr> <td>Color of the lead wire</td> <td>Normal</td> </tr> <tr> <td>BRN - other one</td> <td>282 ~ 306 Ω</td> </tr> </table>		Color of the lead wire	Normal	BRN - other one	240 ~ 260 Ω	Color of the lead wire	Normal	BRN - other one
Color of the lead wire	Normal								
BRN - other one	240 ~ 260 Ω								
Color of the lead wire	Normal								
BRN - other one	282 ~ 306 Ω								

9-6. TROUBLESHOOTING FLOW

**OPERATION INDICATOR lamp flashes 3-time.
Indoor fan does not operate.**

A Check of indoor fan motor

The indoor fan motor error has occurred, and the indoor fan doesn't operate.

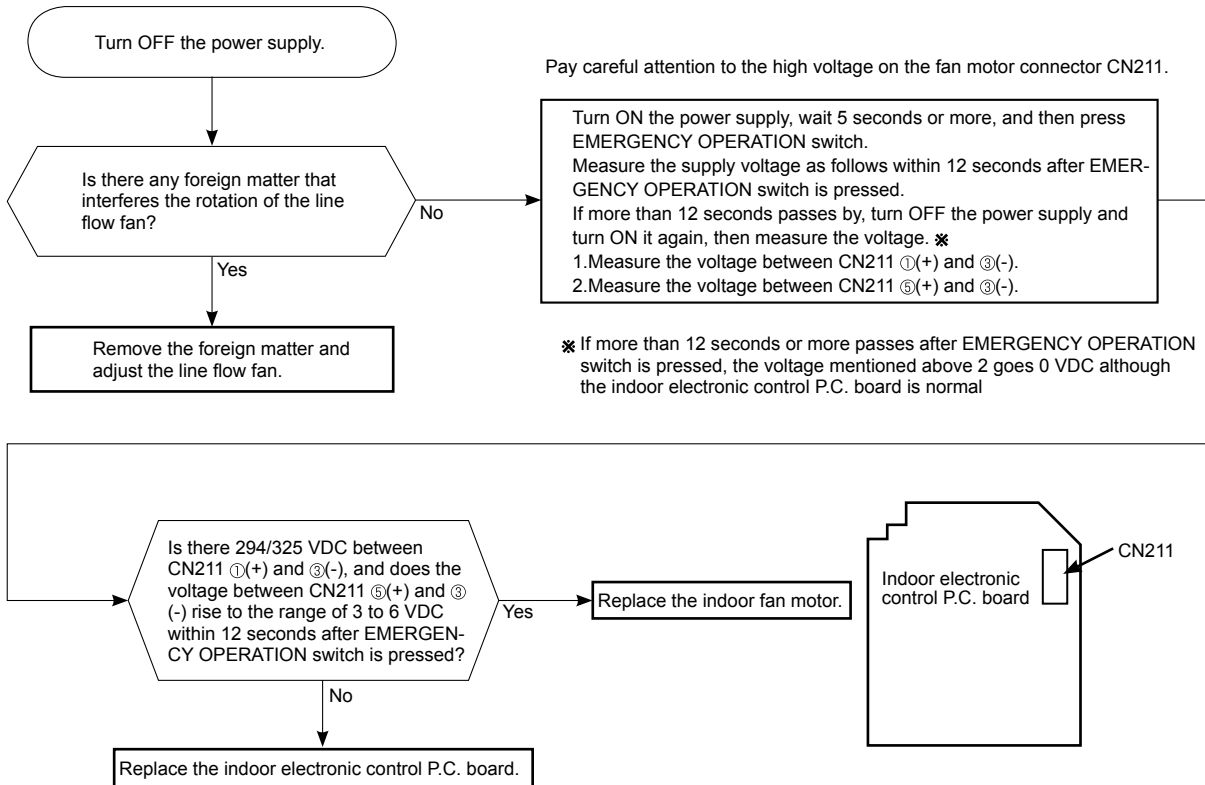

The indoor fan motor error has occurred, and the indoor fan repeats "12-second ON and 30-second OFF" 3 times, and then stops.

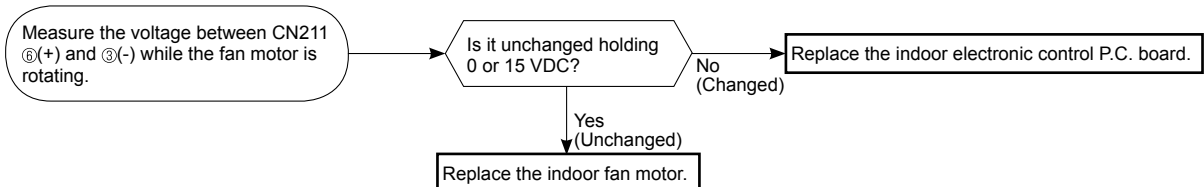

Indoor unit operates by pressing EMERGENCY OPERATION switch, but does not operate with the remote controller.

B Check of remote controller and receiver P.C. board

※Check if the remote controller is exclusive for this air conditioner.

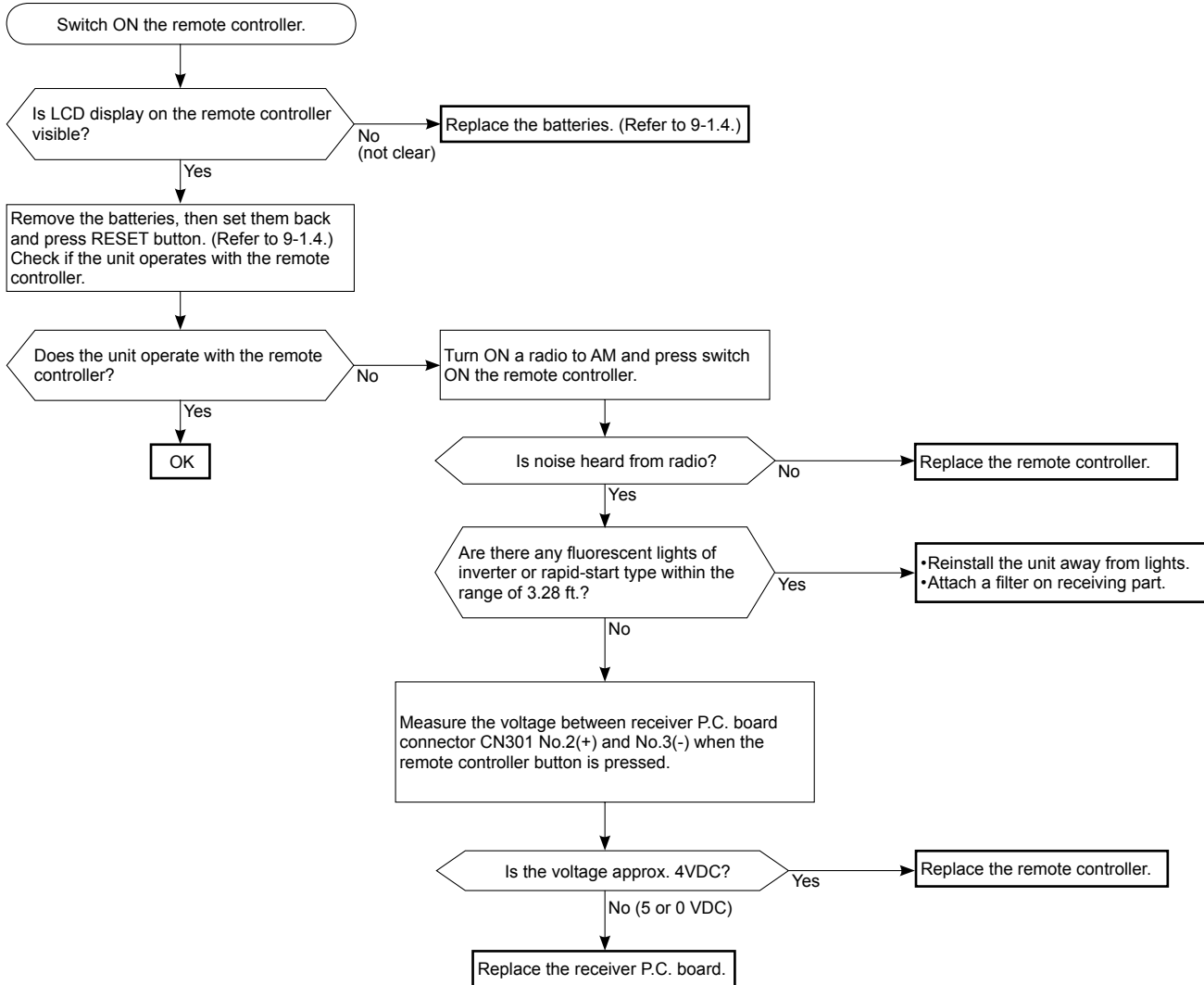

The unit does not operate with the remote controller.
 Also, OPERATION INDICATOR lamp does not light up by pressing EMERGENCY OPERATION switch.

© Check of indoor electronic control P.C. board and indoor fan motor

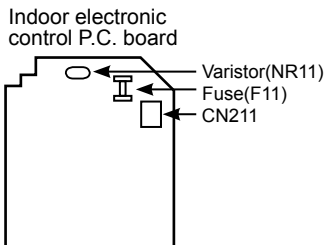
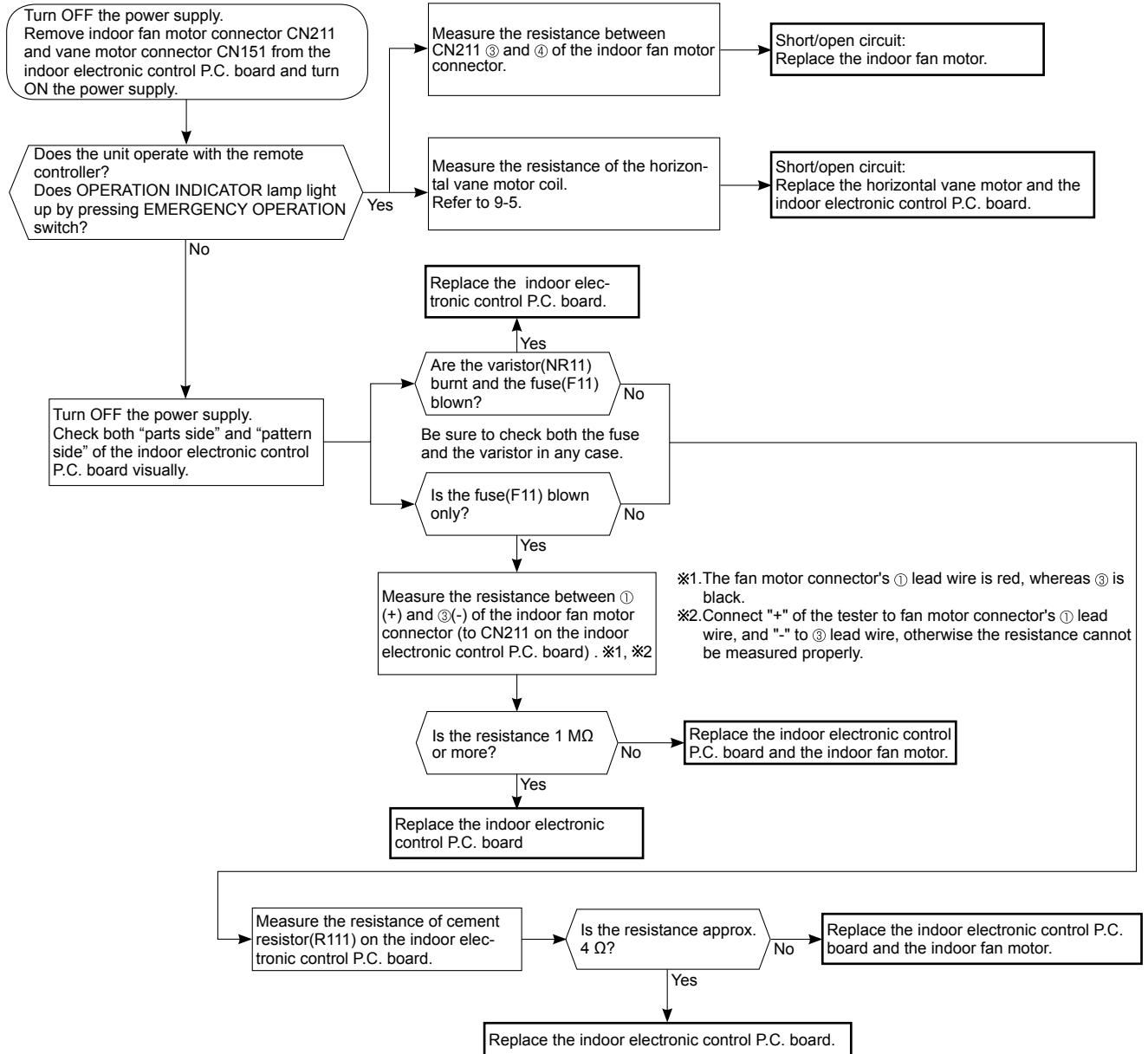

- Unit cannot operate neither by the remote controller nor by EMERGENCY OPERATION switch. Indoor unit does not operate.
- OPERATION INDICATOR lamp flashes ON and OFF every 0.5-second. Outdoor unit does not operate.

D How to check miswiring and serial signal error

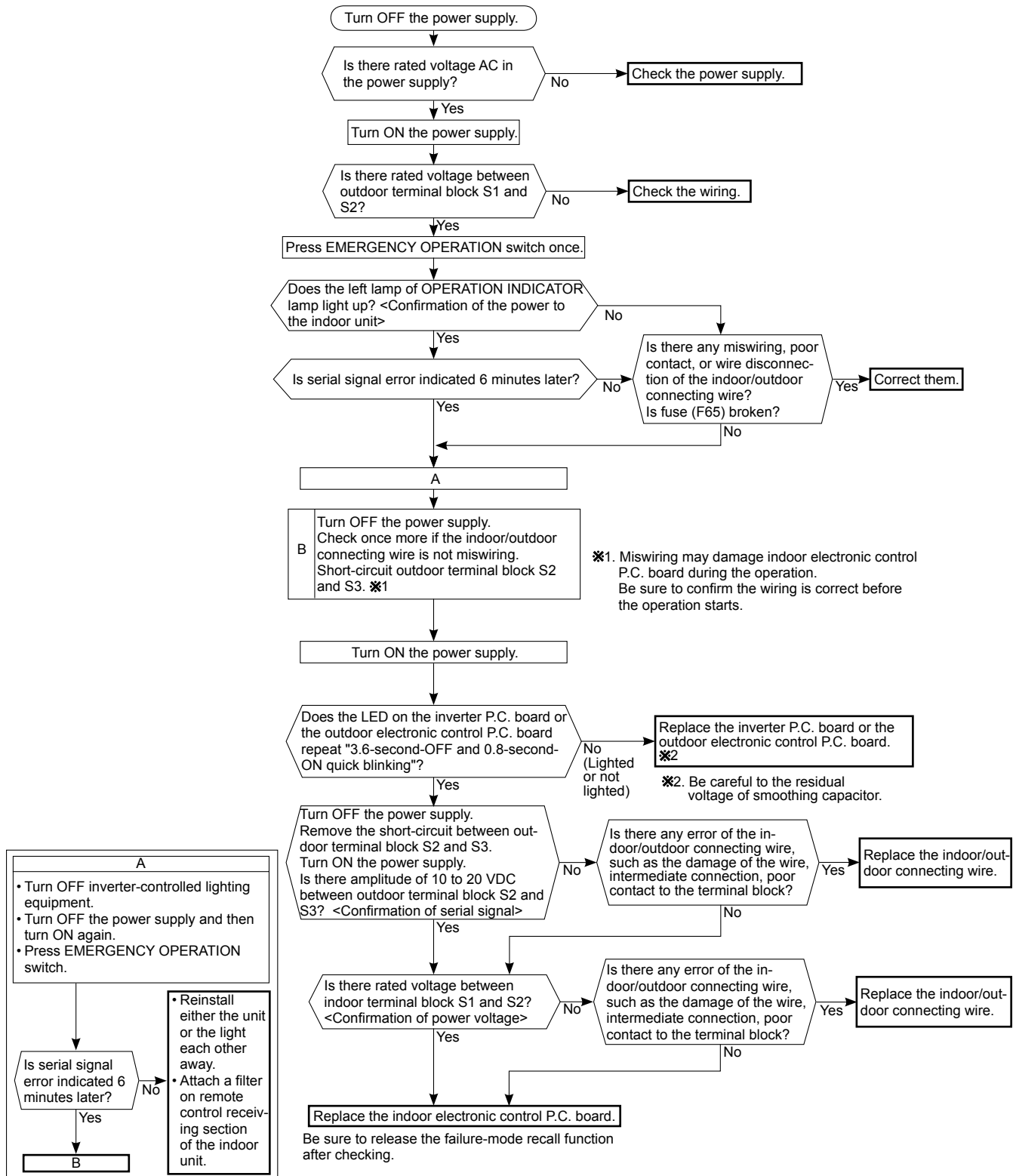

E Electromagnetic noise enters into TV sets or radios

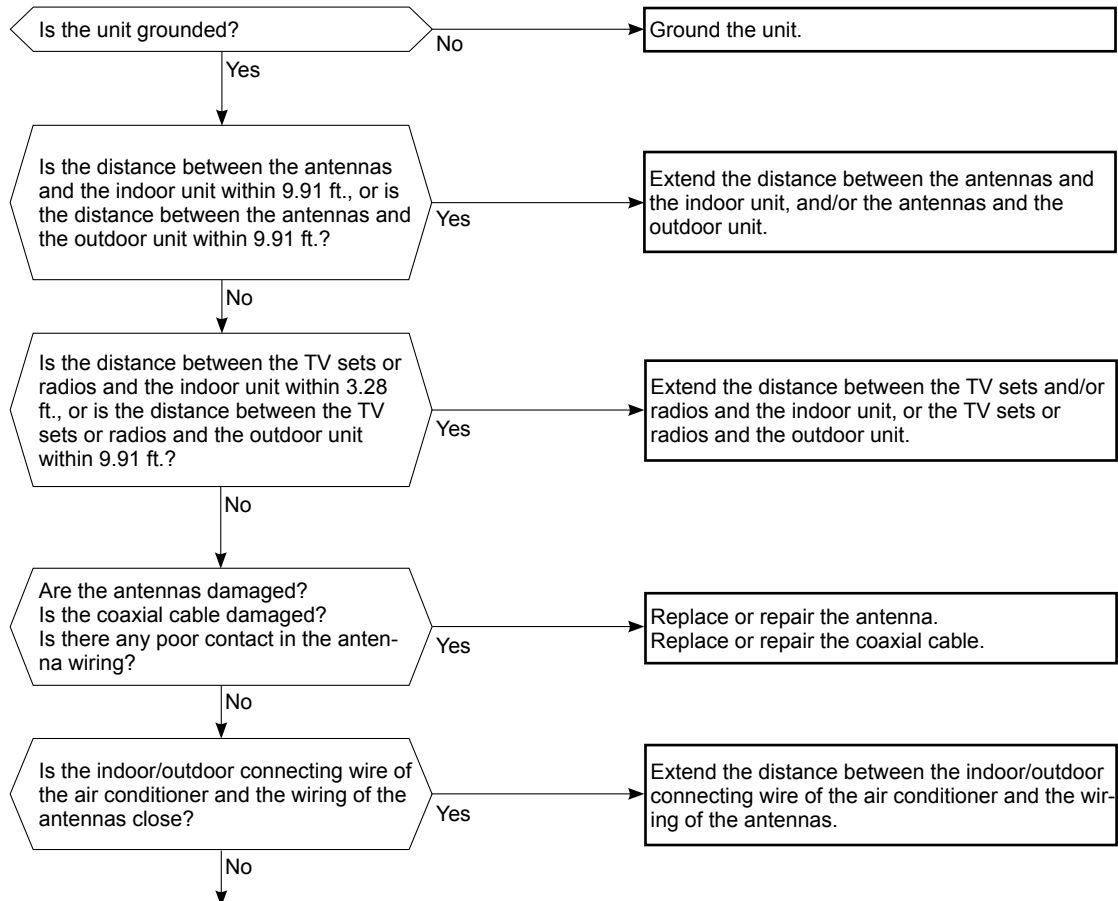

Even if all of the above conditions are fulfilled, the electromagnetic noise may enter, depending on the electric field strength or the installation condition (combination of specific conditions such as antennas or wiring). Check the followings before asking for service.

1. Devices affected by the electromagnetic noise
TV sets, radios (FM/AM broadcast, shortwave)
2. Channel, frequency, broadcast station affected by the electromagnetic noise
3. Channel, frequency, broadcast station unaffected by the electromagnetic noise
4. Layout of ;
indoor/outdoor unit of the air conditioner, indoor/outdoor wiring, grounding wire, antennas, wiring from antennas, receiver
5. Electric field intensity of the broadcast station affected by the electromagnetic noise
6. Presence or absence of amplifier such as booster
7. Operation condition of air conditioner when the electromagnetic noise enters in
 - 1) Turn OFF the power supply once, and then turn ON the power supply. In this situation, check for the electromagnetic noise.
 - 2) Within 3 minutes after turning ON the power supply, press OPERATE/STOP (ON/OFF) button on the remote controller for power ON, and check for the electromagnetic noise.
 - 3) After a short time (3 minutes later after turning ON), the outdoor unit starts running. During operation, check for the electromagnetic noise.
 - 4) Press OPERATE/STOP (ON/OFF) button on the remote controller for power OFF, when the outdoor unit stops but the indoor/outdoor communication still runs on. In this situation, check for the electromagnetic noise.

9-7. TEST POINT DIAGRAM AND VOLTAGE
MSZ-D30NA MSZ-D36NA MSY-D30NA MSY-D36NA
Indoor electronic control P.C. board

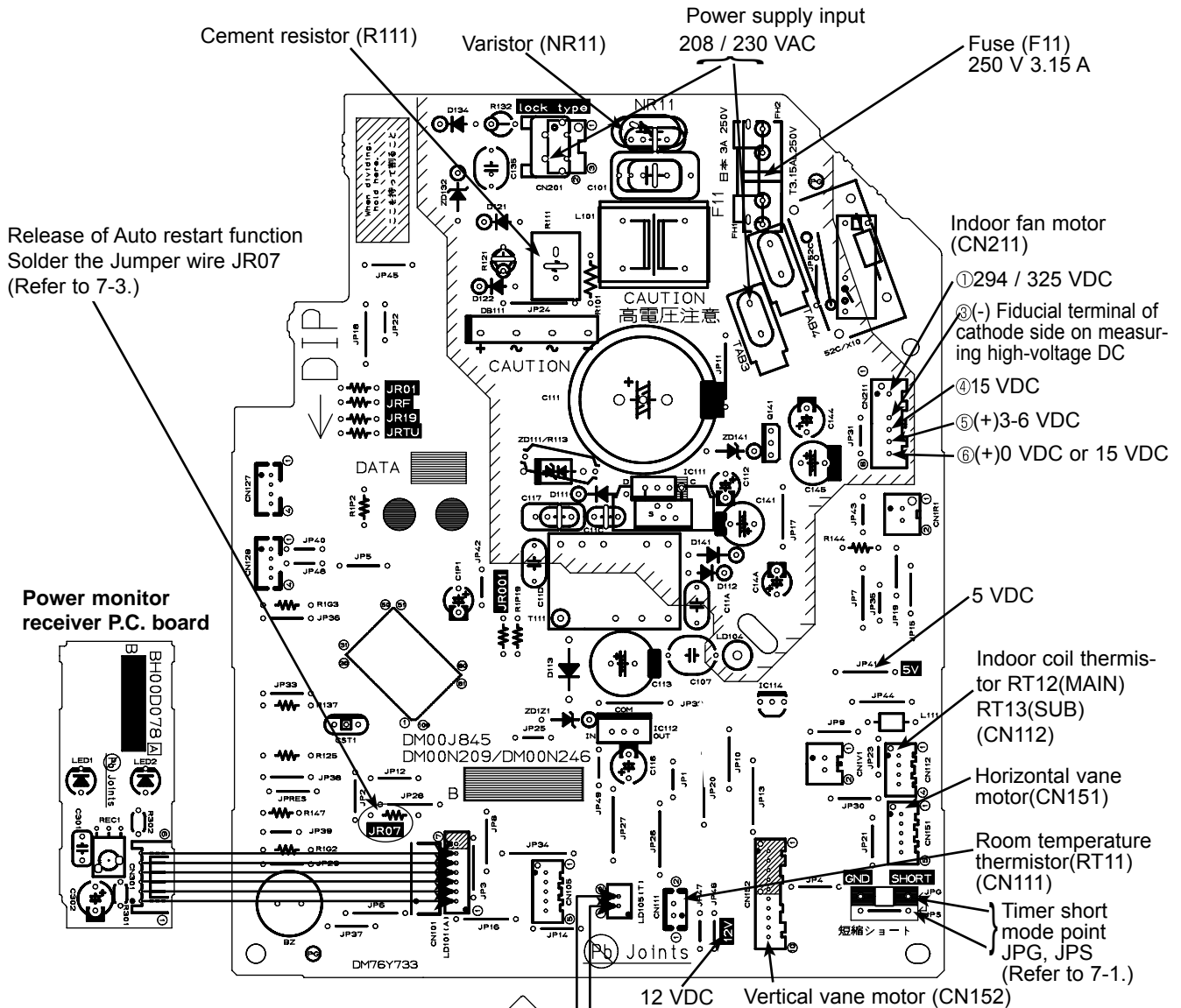

- Indoor fan motor (CN211)
- ① 294 / 325 VDC
- ② (-) Fiducial terminal of cathode side on measuring high-voltage DC
- ④ 15 VDC
- ⑤ (+) 3-6 VDC
- ⑥ (+) 0 VDC or 15 VDC

**Indoor coil thermistor [RT12 (MAIN), RT13 (SUB)]
 Room temperature thermistor (RT11)**

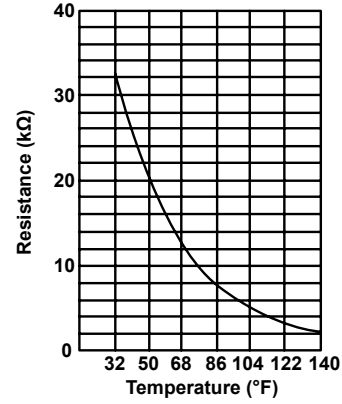

<"Terminal with locking mechanism" Detaching points>

The terminal which has the locking mechanism can be detached as shown below.
There are two types (Refer to (1) and (2)) of the terminal with locking mechanism.
The terminal without locking mechanism can be detached by pulling it out.
Check the shape of the terminal before detaching.

(1) Slide the sleeve and check if there is a locking lever or not.

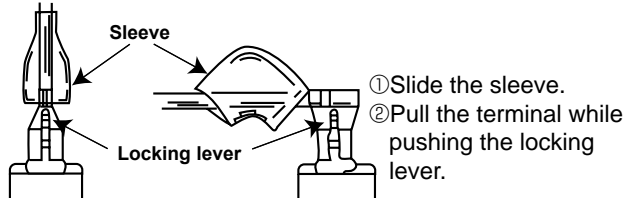

(2) The terminal with this connector has the locking mechanism.

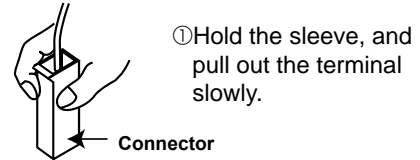

10-1. MSZ-D30NA MSZ-D36NA MSY-D30NA MSY-D36NA

OPERATING PROCEDURE	PHOTOS
<p>1. Removing the panel</p> <ol style="list-style-type: none"> (1) Press and unlock the knobs on both sides of the front panel and lift the front panel until it is level, and then pull the hinges forward to remove the front panel. (2) Remove the screw caps of the panel. Remove the screws of the panel. (3) Hold the lower part of both ends on the panel and pull it slightly toward you, and then remove the panel by pushing it upward. (4) Remove the screw of the corner box. Remove the corner box. 	<p>Photo 1</p> <p>Front panel</p> <p>Screws</p> <p>Screw of the corner box</p>
<p>2. Removing the electrical box, the electronic control P.C. board, the power monitor receiver P.C. board and the SW P.C. board</p> <ol style="list-style-type: none"> (1) Remove the panel and corner box. (Refer to 1.) (2) Remove the screw of the electrical cover. Remove the electrical cover. (3) Remove the screw of the V.A. clamp. (4) Remove the V.A. clamp, then remove the indoor/outdoor connecting wire. (5) Disconnect TAB of the ground wire connected to the indoor heat exchanger. (6) Remove the screw of the electrical side cover. Remove the electrical side cover. (7) Disconnect all the connectors, TAB and TAB4 on the indoor electronic control P.C. board. (8) Remove the screw on lower side of the electrical box. (See photo 3) Remove the electrical box. (9) Remove the indoor electronic control P.C. board. (10) Remove the SW holder from the electrical box. (11) Open the SW holder and pull out the SW P.C. board. (12) Remove the power monitor receiver holder from the electrical box. (13) Open the power monitor receiver holder and pull out the power monitor receiver P.C. board. 	<p>Photo 2</p> <p>Water cut</p> <p>Ground wire to indoor heat exchanger</p> <p>Screw of electrical side cover</p> <p>Screw of electrical cover</p> <p>Screw of V.A. clamp</p> <p>SW holder</p> <p>Power monitor receiver holder</p>

OPERATING PROCEDURE

3. Removing the nozzle assembly

- (1) Remove the panel and the corner box. (Refer to 1.)
- (2) Remove the electrical cover. (Refer to 2.)
- (3) Remove the electrical side cover, disconnect the vane motor connector.
- (4) Pull out the drain hose from the nozzle assembly, and remove the nozzle assembly.

4. Removing the vertical vane motor

- (1) Remove the nozzle assembly. (Refer to 3.)
- (2) Remove the crank of the vertical vane motor unit from the vertical vane.
- (3) Remove the screw of the vertical vane motor unit, and pull the vertical vane motor unit.
- (4) Remove the screws of the vertical vane motor unit cover.
- (5) Remove the crank of the vertical vane motor unit from the shaft of the vertical vane motor.
- (6) Remove the vertical vane motor from the vertical vane motor unit.
- (7) Disconnect the connector of vertical vane motor from the vertical vane motor.

5. Removing the horizontal vane motor

- (1) Remove the nozzle assembly. (Refer to 3.)
- (2) Remove the screws of the horizontal vane motor unit, and pull out the horizontal vane motor unit.
- (3) Disconnect the connector from the horizontal vane motor.
- (4) Remove the screws of the horizontal vane motor.
- (5) Remove the horizontal vane motor.

PHOTOS

Photo 3

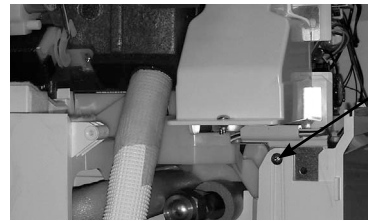

Screw of electrical box

Photo 4

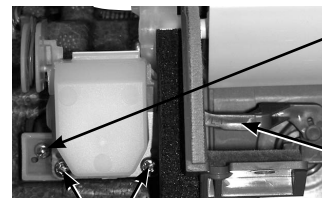

Screws of the vertical vane motor unit

Crank of the vertical vane motor unit

Screws of the vertical vane motor unit cover

Photo 5

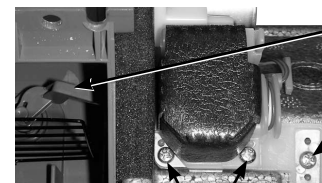

Crank of the vertical vane motor unit

Screws of the vertical vane motor unit

Screws of the vertical vane motor unit cover

Photo 6



Screws of the horizontal vane motor

Screws of the horizontal vane motor unit

OPERATING PROCEDURE

6. Removing the line flow fan and the indoor fan motor

- (1) Remove the panel and the corner box. (Refer to 1.)
- (2) Remove the electrical box. (Refer to 2.)
- (3) Remove the nozzle assembly. (Refer to 3.)
- (4) Remove the water cover.
- (5) Loosen the screw of the line flow fan.
- (6) Remove the screws of the motor bed.
- (7) Remove the lead wire of the indoor coil thermistor from the hooks of the motor bed.
- (8) Remove the motor band and the motor bed together with indoor fan motor. (Be careful not to drop the indoor fan motor because it is heavy.)
- (9) Remove the screw of the motor band, and remove the motor band then pull out the indoor fan motor.
- (10) Remove the screws of the left side of the heat exchanger.
- (11) Lift the left side of the heat exchanger.
- (12) Remove the line flow fan to the lower-left.

Photo 9

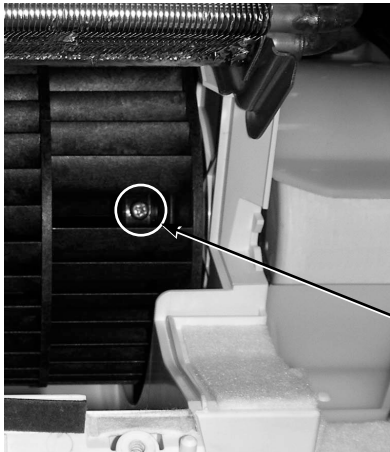

Screw of the line flow fan

PHOTOS

Photo 7

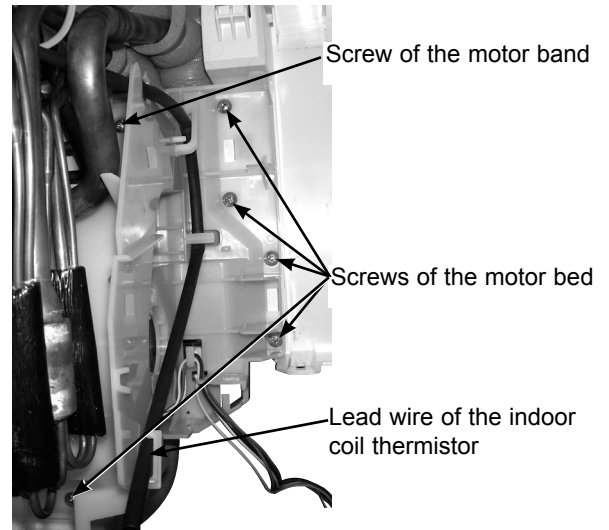
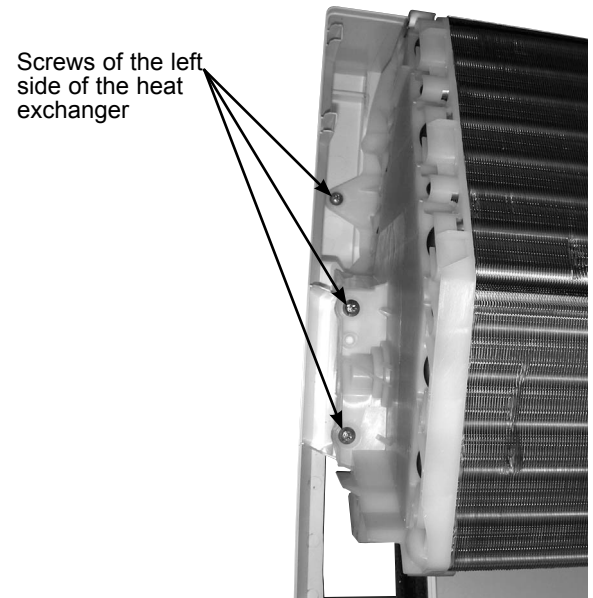

Photo 8



Screws of the left side of the heat exchanger

Mr. SLIM™

 **MITSUBISHI ELECTRIC CORPORATION**
HEAD OFFICE: TOKYO BLDG., 2-7-3, MARUNOUCHI, CHIYODA-KU, TOKYO 100-8310, JAPAN

© Copyright 2008 MITSUBISHI ELECTRIC ENGINEERING CO.,LTD
Distributed in Feb. 2008. No. OBH501 7
Made in Japan

New publication, effective Feb. 2008
Specifications subject to change without notice.

Free Manuals Download Website

<http://myh66.com>

<http://usermanuals.us>

<http://www.somanuals.com>

<http://www.4manuals.cc>

<http://www.manual-lib.com>

<http://www.404manual.com>

<http://www.luxmanual.com>

<http://aubethermostatmanual.com>

Golf course search by state

<http://golfingnear.com>

Email search by domain

<http://emailbydomain.com>

Auto manuals search

<http://auto.somanuals.com>

TV manuals search

<http://tv.somanuals.com>