

Vermont[®] Owner's Manual

READ AND SAVE THESE INSTRUCTIONS!

Safety and the proper operation of your Casablanca fan both require a thorough knowledge of the product and proper installation; therefore, before attempting to install and operate your Casablanca fan, read this owner's manual completely and carefully. Retain this manual for future reference.

Caution: To avoid possible electrical shock, make certain that electricity is turned off at the circuit breaker or fuse box before attempting any installation procedure.

CONTENTS

INTRODUCTION	5
Before You Start	5
Safe Use	5
MOUNTING RECOMMENDATIONS	6
General Guidelines	6
Getting Started	6
CEILING MEDALLION PREPARATION AND INSTALLATION	7
Ceiling Medallion Bracket Installation	7
MOTOR INSTALLATION	8
Motor Housing Installation	10
BLADE PREPARATION AND INSTALLATION	12
LIGHT FIXTURE INSTALLATION	13
VERSA•TOUCH2 [®] CONTROL INSTALLATION	16
Control Bracket Installation	16
Remote Operation	17
Changing Transmitter Frequency Setting	18
TROUBLESHOOTING TIPS	19
CARE RECOMMENDATIONS	20
PRODUCT SPECIFICATIONS	21



PLEASE INSPECT ALL PACKAGING PRIOR TO DISCARDING!

Your Casablanca fan was crafted with pride and care and inspected thoroughly prior to shipment. Before you begin to assemble and install your Casablanca fan, remove all parts from the carton and check them against the Parts Guide in this manual.

Make sure all parts are included in the box using the Parts Guide on the following pages.

If there are missing or broken parts:

Call 1-888-227-2178 Monday through Friday, 7 a.m. to 4 p.m. PST. Your request will be handled immediately. Replacement parts will be sent to you via Federal Express.

Proper Parts Handling

Do not remove lightbulbs from their packaging until you are ready to install them.

Before discarding packaging materials, be certain that all parts have been removed.

Use a clean, dry paintbrush to remove small Styrofoam pieces that may remain after unpacking.

Do not brush Styrofoam into wiring cavities.

The blades in each pack are matched for equal weight to assure smooth fan operation. If more than one fan is being installed, do not mix blades from different cartons.

When cleaning, painting, or working near your fan, be cautious of the fan and blades.

Always turn power to the ceiling fan OFF before replacing lightbulbs or working on your fan.

Never insert anything into the path of the fan blades while the fan is in operation.

Never install a fan over a pool or spa.

Never operate a fan that has been damaged in any way.

Install the fan according to the instructions in this manual.

If the fan does not work:

Refer to the Troubleshooting Tips in this Owner's Manual.

Call Technical Support at 1-888-227-2178.

Contact your local Authorized Service Center.







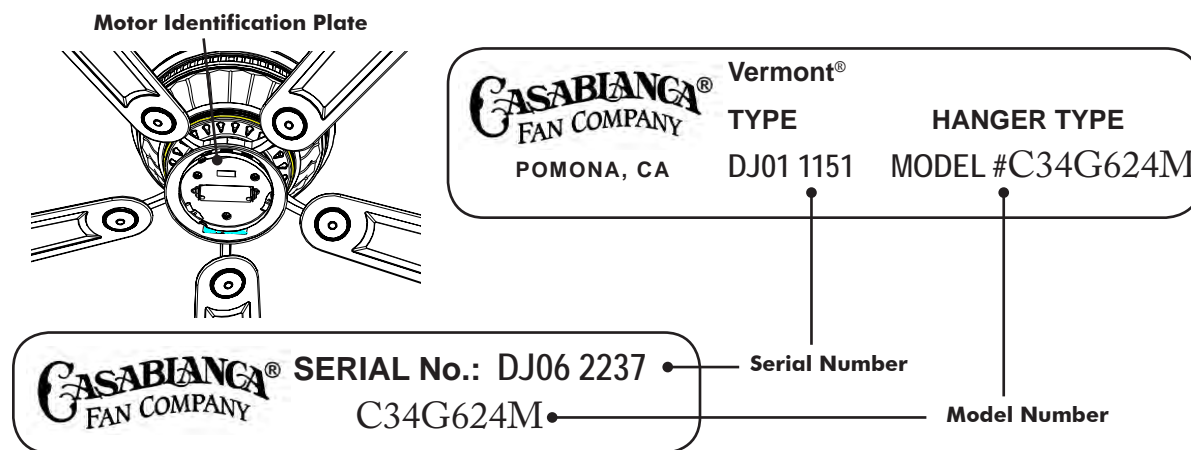







Our Web site at www.casablancafanco.com contains additional information on Casablanca products, troubleshooting, and Authorized Dealer or Service Centers. Please do not return this product to the store.









RECORD MODEL AND SERIAL NUMBERS BEFORE INSTALLATION!

Please take a moment to locate the model number and serial number from your fan (see below) and record this information on the Warranty page inside the front cover of your Owner's Manual if it does not appear there already. These numbers are found on the motor identification plate affixed to the fan motor in the location shown below:



Parts Guide

Item #	Description	Picture (not to scale)	Quantity
1.	Motor Housing		1
2.	Ceiling Mounting Bracket		1
3.	Motor Assembly		1
4.	Phillips Screwdriver		1
5.	Screw Pack (A): 1 1/2" x 8-32" Roundhead screws and Washers		2 EA
6.	Screw Pack (A): 1 1/2" Wood Screws and Washers		2 EA
7.	Screw Pack (A): 3" Wood screws and Washers		2 EA
8.	Screw Pack (A): Wire Nuts (4),		4
9.	Screw Pack (B): Hole Plugs		4
10.	Screw Pack (B): Motor Housing Mounting Screws		2
11.	Blades		5
12.	Blade Irons		5
13.	Blade Medallions		5
14.	Screw Pack (C): Blade Screws		21
15.	Screw Pack (D): Blade Iron Screws		11

Item #	Description	Picture (not to scale)	Quantity
16.	Light Kit		1
17.	Socket Plate		1
18.	Screw Pack (E): Switch Housing Plate Screws		3
19.	Screw Pack (E): Socket Plate Screws		3
20.	Halogen Lightbulb, 100W		1
21.	Lightbulb Shield		1
22.	Glass Shade		1
23	W-72 Control, Bracket, Battery, and Mounting Hardware		1



INTRODUCTION BEFORE YOU START

- **CAUTION: RISK OF ELECTRICAL SHOCK!** Installation is to be in accordance with the National Electrical Code, ANSI/NFPA 70-1999, and local codes. If you are unfamiliar with the wiring codes, you should use a qualified electrician. To avoid overheating and possible damage to other equipment, do not install control to a receptacle, fluorescent light fixture, motor-operated appliance, or transformer-supplied appliance.
- This fan is designed to be installed on an existing electrical outlet box. The outlet box must be UL Listed for ceiling fan installations. If it is not, a new box must be installed.
- This ceiling fan requires a grounded electrical supply of 120 VAC, 60 Hz and a minimum 15 amp circuit. The maximum current requirement for the fan with light fixture is 2.17 amps. The fan uses about .71 amp or 85 watts. Maximum light current is about .83 amps or 100 watts of lighting.
- Where wire nuts are employed, be sure all bare wires are within the connectors.
- **WARNING:** Do not bend the blade brackets when installing the brackets, balancing the blades, or cleaning the fan. Do not insert foreign objects in between the rotating fan blades.

Unpacking

Before assembling and installing your ceiling fan, remove all parts from the shipping cartons and check them against the parts listed in the Parts Guide. Before discarding packaging materials, be certain that all parts have been removed.

**For best performance and for your warranty to be valid,
use only genuine Casablanca blades, light fixtures, and accessories.**

SAFE USE

- The blades in each pack are matched for equal weight to assure smooth fan operation. If more than one fan is being installed, be careful not to mix blades from different cartons.
- Inspect the contents of your carton for possible shipping or handling damage. If parts are missing or damaged, call 1-888-227-2178.
- It is always a good idea to have an assistant to help with the installation.
- When cleaning, painting, or working near your fan, be very careful of the fan and blades. Always turn the power OFF to the ceiling fan before working on it or replacing lightbulbs.
- Never insert anything into the path of the fan blades while the fan is in operation.
- Never install a fan over a pool or spa.
- Never operate a fan that has been damaged in any way. For assistance in obtaining service, call Casablanca Fan Company at 1-888-227-2178 or contact your local authorized Casablanca dealer.

Fuse Box
(Remove fuse for the circuit you will be working on)

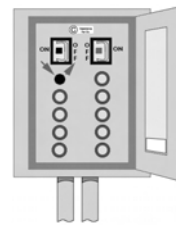

Circuit Breaker
(Trip breaker for the circuit you will be working on)

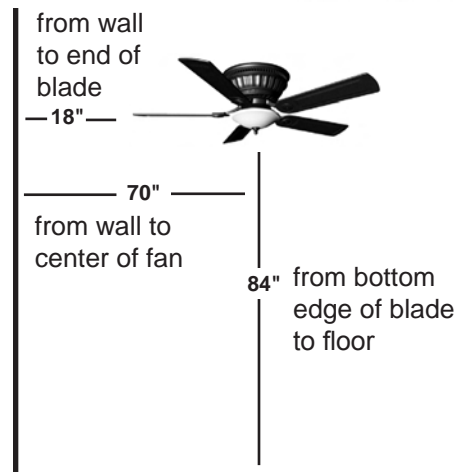
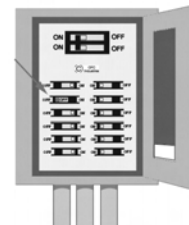

Dimensions indicated are the minimum allowable for proper installation.

MOUNTING RECOMMENDATIONS

GENERAL GUIDELINES

Before mounting your Casablanca fan, read the following helpful recommendations. The location of the fan, air circulation, and fan size are all important factors to consider before installation.

Location

Ceiling fans have practical uses in almost every room in your home. We suggest you follow these mounting recommendations as you decide where to install your Casablanca fan.

- This fan is not suitable for installation on a sloped ceiling.
- For safety reasons, the fan blades must be a minimum of 7' above the floor.
- Do not locate the fan in a doorway or above a swinging door.
- In any installation, the tips of the blades must be at least 18" from the wall in order to provide sufficient clearance for the blades.
- In bedrooms, fans work best when mounted above the foot of the bed.
- Over pool tables, be sure to provide plenty of clearance to avoid damage from pool cues.
- In kitchens be sure to allow for open cupboard doors to clear the fan blades.
- Do not install a fan close to, or over, a pool or spa. High humidity combined with corrosive gases will destroy the finish and warp the blades.

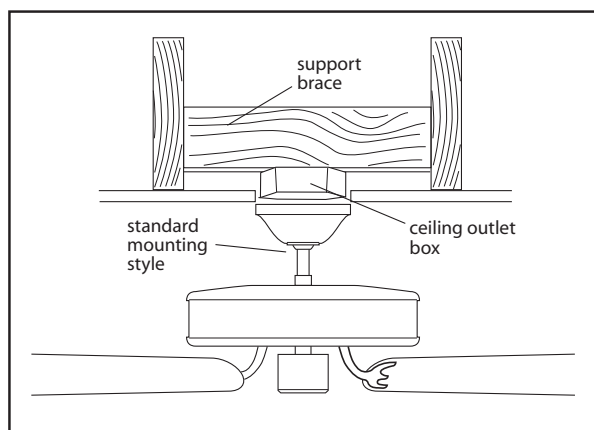
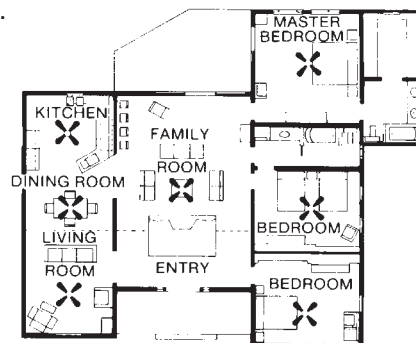

Fan Size

Variable fan speed capability permits the use of a full-size 52" fan even in smaller rooms. For very large rooms, two fans may be needed.

GETTING STARTED

Using Existing Ceiling Fixture Outlet Box

After turning the power OFF at its source (either circuit breaker or fuse box), lower the old fixture and disconnect the wiring. Check the ceiling fixture outlet box to be sure that it is marked "Approved for Ceiling Fan Mounting." If it is not, a new box must be installed.

Installing a New Ceiling Fixture Outlet Box

If you do not have an existing fixture located where you wish to place your Casablanca fan, an approved ceiling fixture outlet box must be installed and wired.

WARNING!

To reduce the risk of fire, electrical shock, or personal injury, mount to outlet box marked "Acceptable Fan Support of 22.7 kg (50 lbs.) or less" using the mounting hardware provided with the outlet box.



CEILING BRACKET PREPARATION AND INSTALLATION

CEILING BRACKET HARDWARE (not to scale)



Ceiling Mounting Bracket



Motor Assembly



Screw Pack A:
1 1/2" x 8-32"
Roundhead screws (2),
washers (2),



Phillips
Screwdriver



Screw Pack A:
1 1/2" Wood Screws (2),
washers (2),



Screw Pack A:
Wire Nuts (4),



Screw Pack A:
3" Wood screws (2)
washers (2),

CEILING BRACKET BRACKET INSTALLATION

Step 1. Route the outlet box wires through the center hole of the ceiling bracket. Attach the ceiling bracket to the outlet box with the mounting hardware included with the outlet box, ensuring that the outlet box wires are not pinched by the washers or between the mounting bracket and the ceiling.

CAUTION:
To reduce the risk of personal injury, use only the mounting hardware provided with the approved outlet box to install the ceiling bracket.

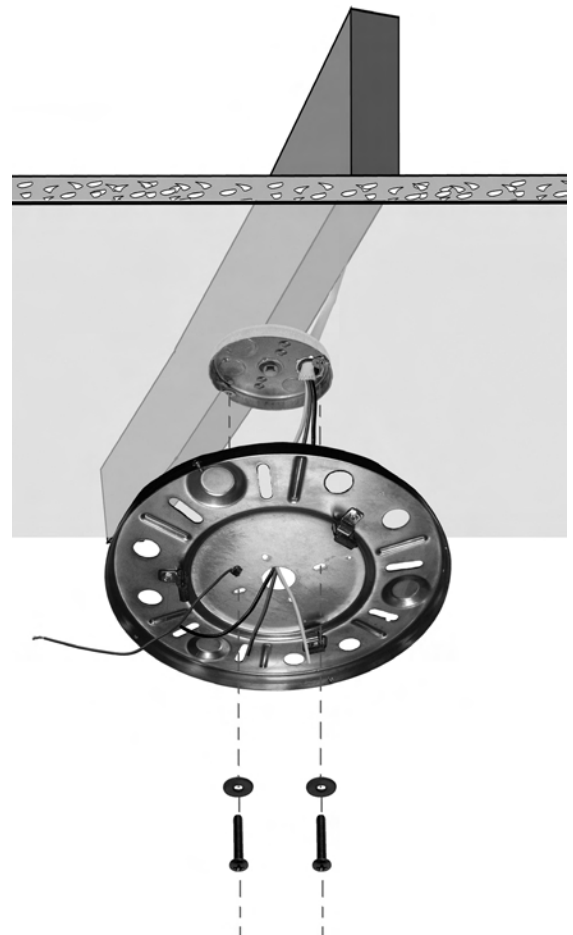

MOTOR INSTALLATION

Step 2a. Attach one of the hooks on the outside of the motor onto one of the loops hanging from the ceiling bracket as shown in Figure #1.

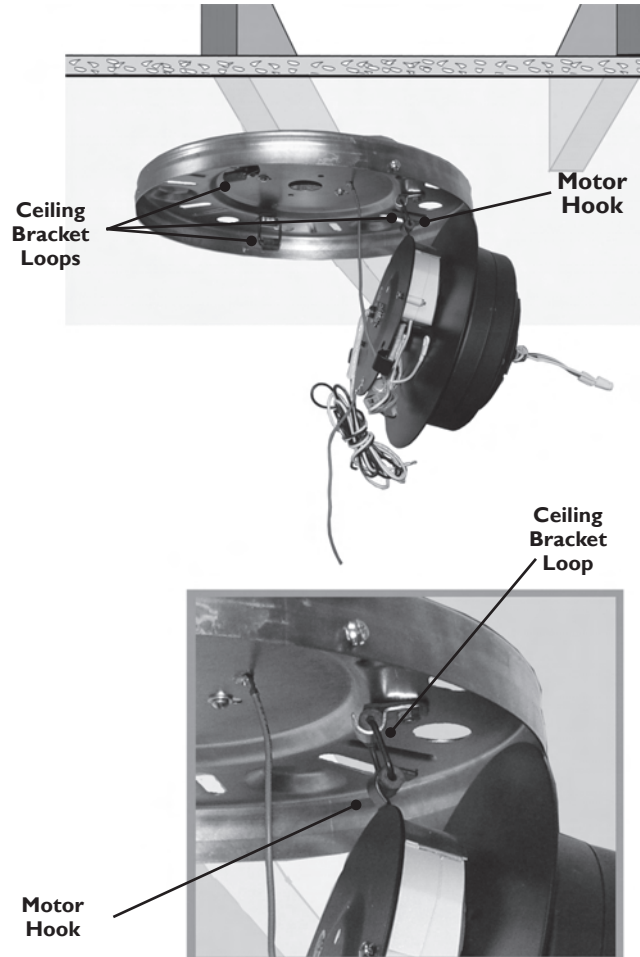

Figure #1

Step 2b. Trim excess motor wires to six inches and attach the fan wires to the ceiling bracket wiring by placing the bare end of the wires side by side and then securing with a wire nut. Test that the connection is secure by pulling on the wire nut. Connect in this order:

- GREEN leads from ceiling bracket and motor to GROUND conductor of power source. Secure with wire nut as shown in Figure #2.
- WHITE wire from fan to white NEUTRAL wire in ceiling bracket to the WHITE NEUTRAL conductor wire from the power source. Secure with wire nut as shown in Figure #2.
- BLACK wire from fan to BLACK wire in ceiling bracket to the BLACK conductor wire from the power source. Secure with wire nut as shown in Figure #2.

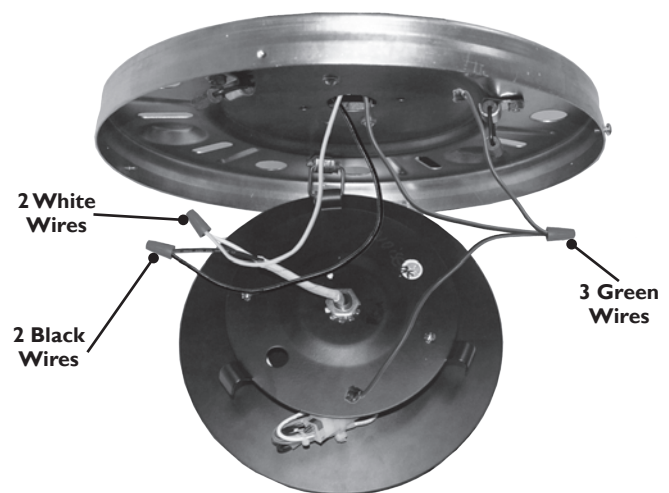

Figure #2



Step 2c. Lift up on the motor, attach the second hook on the outside of the motor onto one of the other loops hanging from the ceiling bracket as shown in Figure #3.

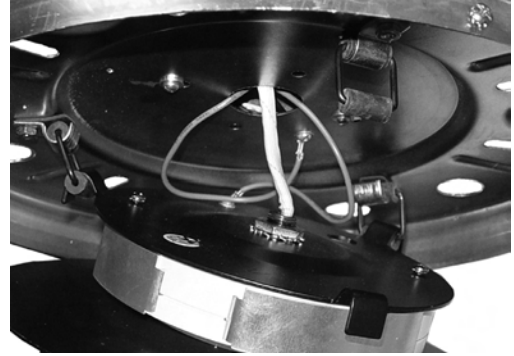

Figure #3

Step 2d. After making the wire connections, the wires should be tucked in to the outlet box as shown in Figure #4. The wires should be spread apart, with the three grounded conductor wires being placed on one side of the outlet box and the power conductor wires being placed onto the other side of the outlet box separating the connections.

NOTE: If the color of your ceiling wires differs from that described, consult an electrician.



Figure #4

Step 2e. Lift up on the motor again and place the third motor hook located on the side. Hang the hook onto the last hanger loop on the ceiling bracket as shown in Figure #5.



Figure #5

MOTOR HOUSING INSTALLATION

CEILING BRACKET HARDWARE (not to scale)



Motor Housing



Screw Pack (B)
Motor Housing Mounting
Screws (2)



Screw Pack (B)
Hole Plugs (4)

Step 3a. Locate and loosen the two motor housing mounting screws that are located on the side of the ceiling mounting bracket as shown in Figure #1.

Step 3b. Install the motor housing by aligning the two slots on the inside of the motor housing with the heads of the two mounting screws that are mounted on each side of the ceiling mounting bracket as shown in Figure #2. Then rotate the motor housing counter clockwise until the heads of the two screws on the ceiling mounting bracket lock together, attaching the motor cover to the ceiling plate as shown in Figure #3.

NOTE: When aligning the screws, center the motor housing so that there is an even amount of space all around the motor.

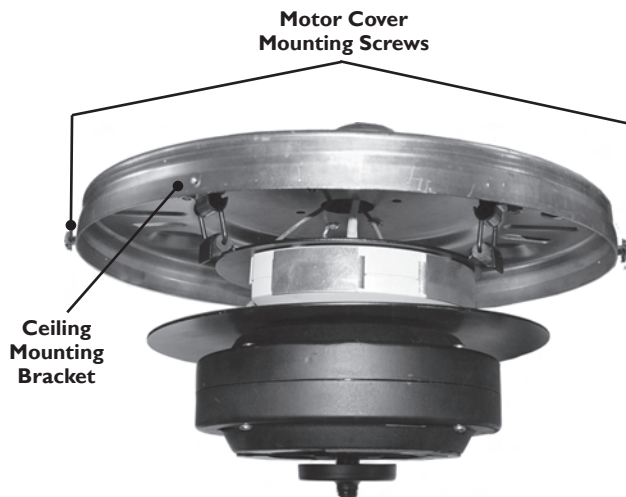

Figure #1

Motor Cover
Mounting Screws

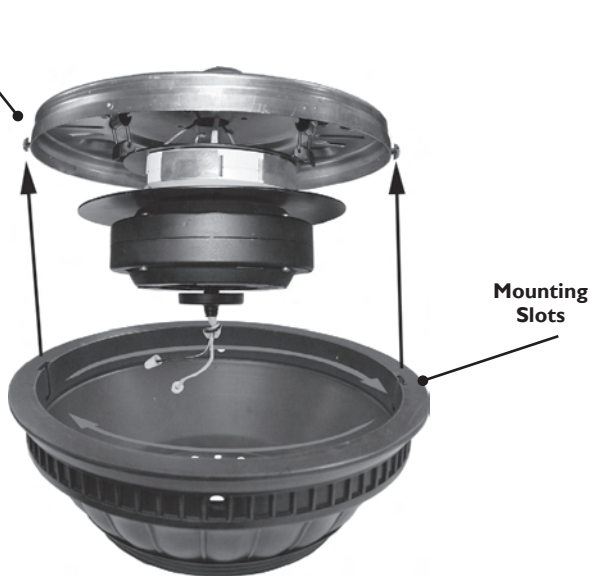

Figure #2



Figure #3



Step 3c. Install the last two of the four motor housing mounting screws holding the motor cover to the ceiling mounting plate as shown in Figure 4. Tighten all four screws until hand tight.



Figure #4

Step 3d. Insert the four hole plugs as shown in Figure #5 covering the heads of the screws. The plugs inserted should look like Figure #6.



Figure #5



Figure #6

BLADE PREPARATION AND INSTALLATION

BLADE HARDWARE (not to scale)



Blades (5)



Blade Irons (5)



Blade Medallions (5)



**Screw Pack C
Blade Screws (21)**



**Screw Pack D
Blade Iron Screws (11)**

Step 4a. Attach blade to bladeholder by first pressing the blade badge onto the blade (Pack C), then attaching the bladeholder using the four blade screws provided as shown in Figure #1. Using the provided screwdriver, tighten securely by hand only. Repeat for each blade assembly.

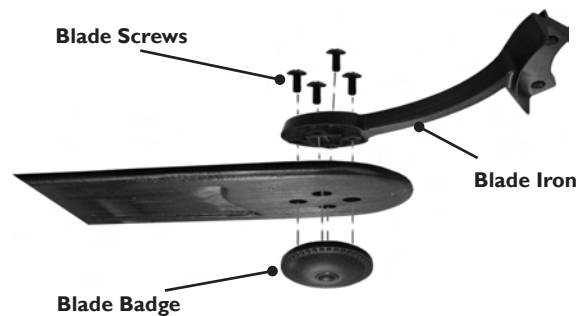

Figure #1

Step 4b. Attach each blade/bladeholder assembly to the motor by threading two blade iron screws (Pack D) through the matching holes in the blade iron and the motor as shown in Figure #2. Using the Phillips screwdriver, tighten the screws loosely. After all five blade assemblies have been installed, tighten the screws with the screwdriver as shown in Figure #3.

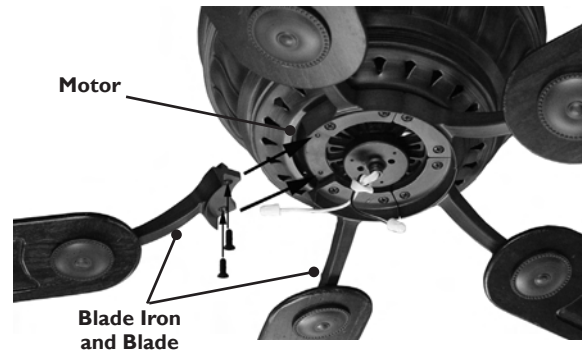

Figure #2



Figure #3



LIGHT FIXTURE INSTALLATION

LIGHT FIXTURE HARDWARE (not to scale)



Light Kit



Pack E
Socket Plate
Screws (3)



Pack E
Switch Housing Plate
Screws (3)



Socket Plate



Lightbulb Shield



Halogen Lightbulb



Glass Shade

Step 5a. Locate the three switch housing plate screws in pack E. Screw in part way two of the three screws in the switch housing plate as shown in Figure #1.

Step 5b. Hold the light kit up to the motor. Feed the wires through the center hole and align the two switch housing screws with the keyholes. Twist the switch housing clockwise as shown in Figures # 2.

Step 5c. Insert the third screw and tighten screws with the provided screw driver attaching the light kit to the switch housing plate as shown in Figure #3.

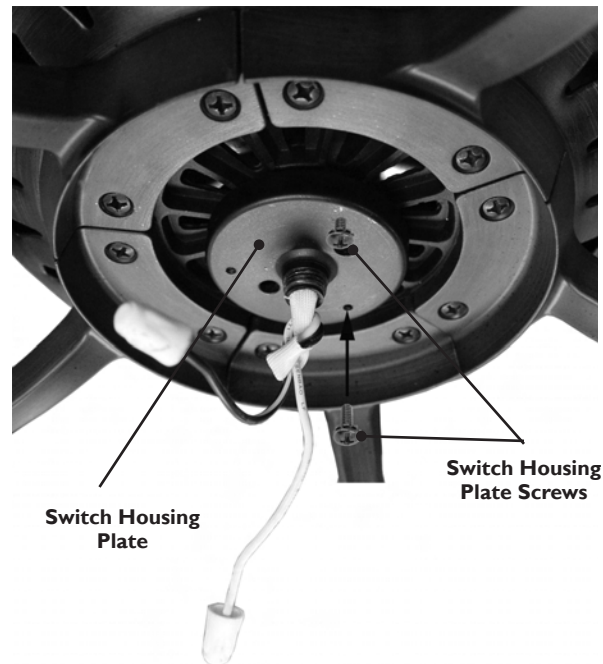

Figure #1



Figure #2

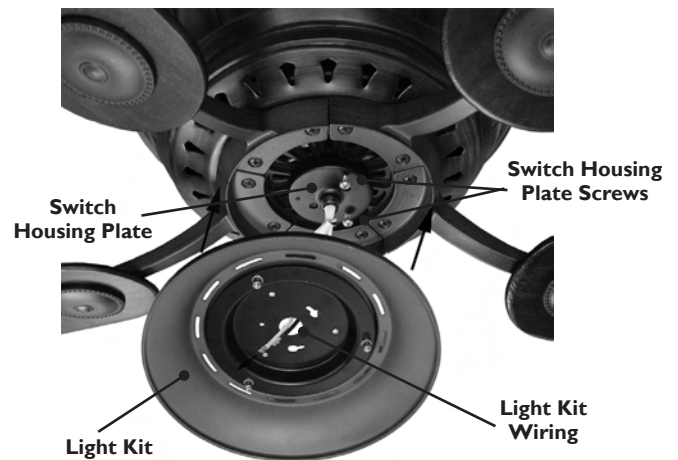

Figure #3

Step 5d. Remove the ceramic wire nuts from the wires and set aside for use in the next two steps.

- Attach the WHITE wire on the socket plate to the WHITE wire coming from the bottom of the motor. Secure with a ceramic wire nut.
- Attach the WHITE wire on the socket plate to the BLACK wire with white stripe coming from the bottom of the motor. Secure with a ceramic wire nut.

Step 5e. Carefully tuck in the wires so they do not get pinched. Align the three holes on the socket plate with the screw holes on the switch housing. Insert three socket plate screws (Pack E) and tighten until secure using the screwdriver as shown in Figure #1.

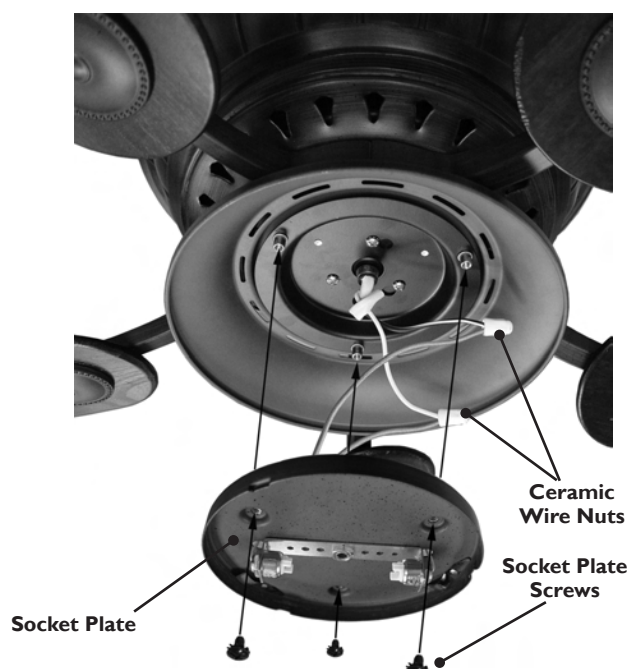

Figure #1

GLASS INSTALLATION

Install Halogen Bulb

Step 6a. Insert one end of the halogen bulb into the socket. Push the end of the socket, then insert the other side of the halogen bulb into the socket. as shown in Figure #2.

Step 6b. Install the glass shield by pushing it into place with the clips on the light socket as shown in Figure #3.

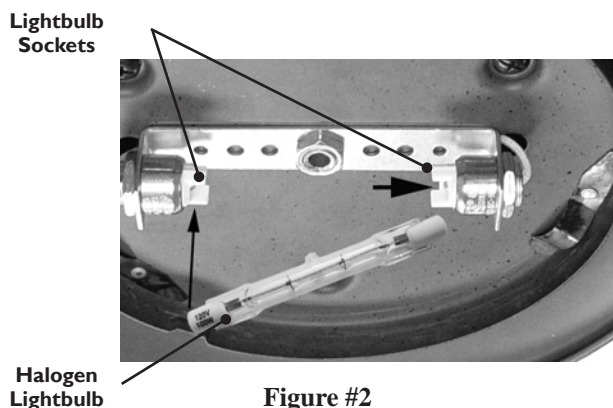

Figure #2

CAUTION:

The halogen bulb is very delicate and should not be handled with bare hands. After removing it from the box, grasp it gently by the plastic covering or a soft cloth.

NOTE: In compliance with US Federal Energy Regulations, this ceiling fan contains a device that restricts the light fixture to a maximum of 190 watts. Exceeding that limit or the marked limit on this product may result in a fire hazard or improper operation.

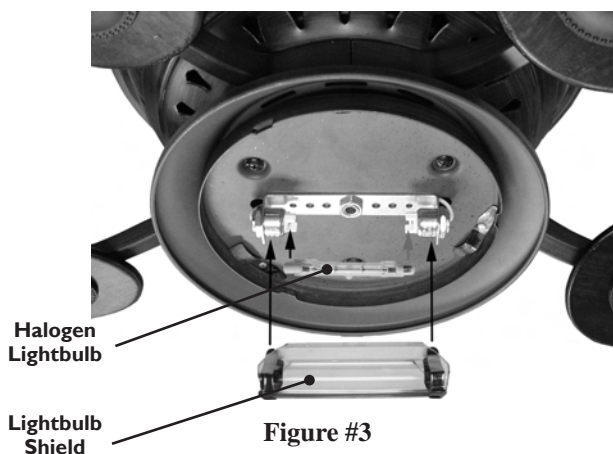

Figure #3



Step 7a. Position the indentations in the outer rim of the glass shade so that they line up with the tabs on the inside surface of the fan light fixture rim.

Step 7b. Carefully lift the glass shade up inside the light fixture as far as it will go. Rotate the shade in a clockwise direction until it is held tightly in place by the three tabs as shown in Figure #1.



Figure #1



Figure #2



VERSA•TOUCH2®

VERSA•TOUCH2® CONTROL INSTALLATION

VERSA•TOUCH2® HARDWARE (not to scale)



W-72 Control



W-72 Control Holder



12v Battery



Drywall Anchor
6-32 (2)



Wood Screw
1" (2)



Screw
6-32 X 3/8" (2)



Screw
6-32 X 1" (2)

CONTROL BRACKET INSTALLATION

SAFETY FIRST: To reduce the risk of electrical shock, this fan must be installed with an isolating wall control/switch. **CAUTION!** Do not use with wall dimmer.

WARNING: To reduce the risk of fire or electric shock, do not use this fan with any solid state speed control device. Use only the control provided with this fan.

Step 8. Follow instructions for the type of transmitter control bracket you will be using.

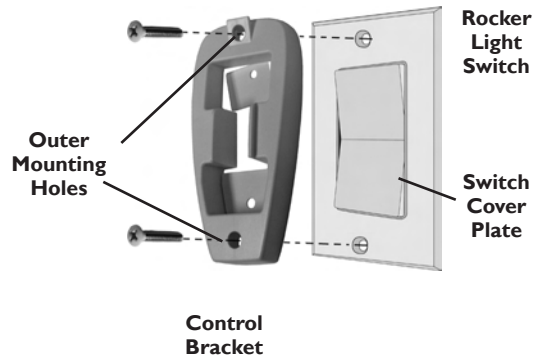
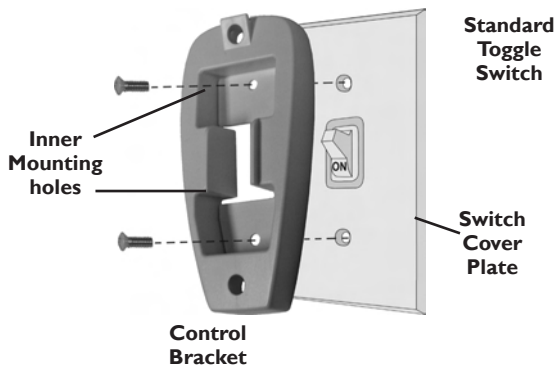

Standard Light Switch

Step A. Remove the two screws holding the switch cover plate. Do not remove the cover plate.

Step B. Orient the control bracket as shown and line up the two inner mounting holes with those on the switch.

Step C. Insert and tighten the screws using the provided screwdriver.

Rocker Light Switch

Step A. Break off the two tabs by pushing outward.

Step B. Remove the two screws holding the switch cover plate. Do not remove the cover plate.

Step C. Orient the control bracket as shown and line up the two inner mounting holes with those on the switch.

Step D. Insert and tighten the screws using the provided screwdriver.

Wall Installation

Step A. Locate a 2x4 wall stud in a convenient location.

Step B. Orient the control bracket as shown over the 2x4 stud.

Step C. Insert the 1" wood screws in either the inner or outer mounting holes and tighten using the provided screwdriver.

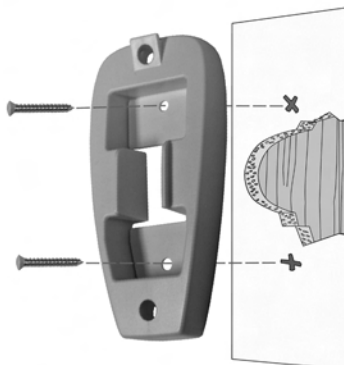

NOTE: The wall anchors and 6-32 x 1" screws may be used in situations where mounting to a stud is not possible. Use the inner mounting holes. After securing the anchor, discard the anchor's pointed screws and use the 6-32 decor ovalhead screws supplied.

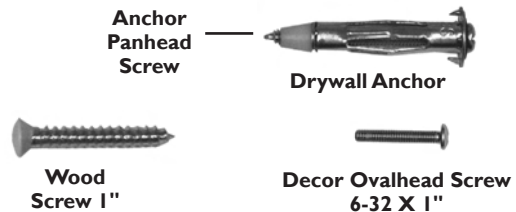



REMOTE OPERATION

Fan Control

To start the fan. Press the selected speed button to run the fan at the desired speed.

LOW=Low speed MED=Medium speed HIGH=High speed

To turn off the fan, press the FAN OFF button.

Airflow Direction

To reverse the airflow, press the REVERSE button. REVERSE operates at any speed whether the fan is on or off. The fan returns to its set speed after reversing.

Light Control

Turn the light on or off independently from the fan by pressing the LIGHT button. If you press the button for more than 0.7 seconds, it becomes a dimmer. The light varies from "bright" to "dim" over approximately 8 seconds. If you continue to hold the LIGHT button, this sequence will reverse when the light reaches its brightest or dimmest level. Release the button when the desired level is reached.

Memory Feature

The last light function and fan speed will resume when power is turned back on.

Auto Resume

Quick (pressing less than 0.7 seconds) on/off operation of the LIGHT button maintains the desired brightness level set previously.

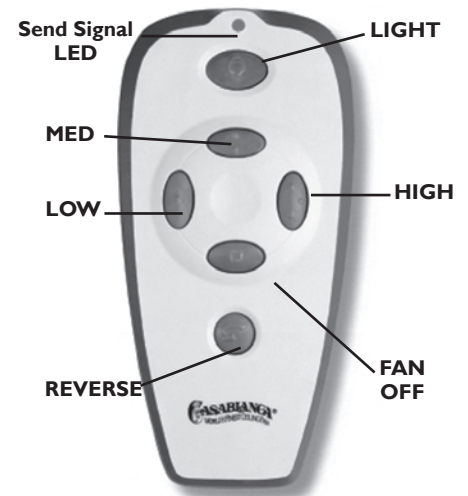

BATTERY INSTALLATION

Remove Battery Door

Turn control on its front. Twist a coin or use your finger to unsnap the door **A**. Lift door away from control **B**.

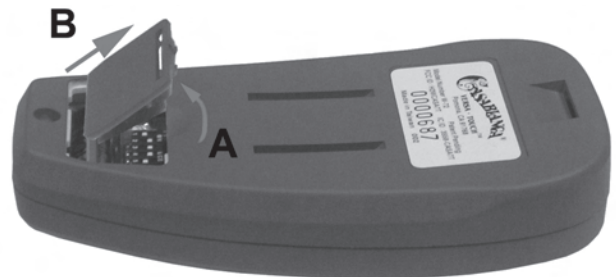

Install Battery

Press battery into control aligned as shown. Observe proper polarity. Replace the battery door.



12V BATTERY

CHANGING TRANSMITTER FREQUENCY SETTING

Note: All fans leave the factory set to "00000."

You will only have to change the dip switch settings in the remote if you are using more than one fan in the same area and want to control them separately.

Step 1. At the circuit breaker or fuse box, turn the power off for the fan you want to change.

Step 2. Open the battery door of the Versa•Touch control and remove the batteries.

Step 3. Change the dip switch settings, assuring that they are different from the previously installed Versa•Touch fan.

Step 4. Re-install the batteries and the battery door on the control.

Step 5. At the circuit breaker or fuse box, turn the power back on for the fan whose frequency you are changing.

Step 6. Within 20 seconds of restoring power, push the HIGH, MED, and LOW buttons (in that order).

Note: You may want to label your controls to assure you do not mix them up.

If the fan is not functioning after installation:

Step 1. Check to make sure that batteries are installed correctly in the control.

Step 2. Turn the power off to the fan (from the circuit breaker) for at least 5 seconds.

Step 3. Turn the power back on (at the circuit breaker) and push the HIGH, MED, and LOW buttons—in that order—within 20 seconds.

Step 4. The fan should now function properly.



Versa•Touch 2
Control
(back)

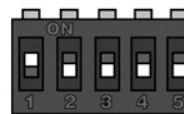

Dip Switch
Set to "10000"

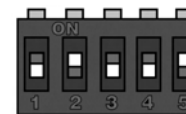

Dip Switch
Set to "01001"

WARNING!

Do not turn the power off at the circuit breaker, then back on, for the previously installed Versa•Touch2 fan(s), as you may inadvertently change the frequency settings for it as well.

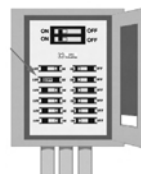

Circuit Breaker
or Fuse Box



Press in this order to set new frequency:

1. HIGH 2. MED 3. LOW



TROUBLESHOOTING TIPS

Please refer to this troubleshooting guide before requesting service or contacting your dealer for assistance.

PROBLEM	POSSIBLE REMEDIES
Fan will not start	<ul style="list-style-type: none"> • Check the main circuit fuses, circuit breakers, and wall switch position. Check all wire connections. Make sure the power is turned off during this inspection. • The 9-pin connector is not making good contact. Check the 9-pin connector in the receiver mounted in the switch housing. • The battery is weak. Install a fresh battery. • The fan receiver is defective. Replace fan receiver. • Check the frequency setting: Turn the power off at the circuit breaker, only for the fan that is not functioning. Check that the jumper switches match in both the receiver and the transmitter.
Fan wobbles or shakes excessively	<ul style="list-style-type: none"> • Be sure the canopy pin is set properly into the slot on the ball. • Check that the bladeholders have not been bent during installation and the blades are balanced. • The hanger bracket and/or ceiling outlet are attached too loosely. Make sure the hanger bracket is attached tightly to the ceiling outlet box and the downrod assembly is secured firmly. • The downrod is attached to downrod base too loosely. Make sure all the screws are securely tightened.
Fan is noisy during operation	<ul style="list-style-type: none"> • Check and tighten the light fixture retaining screws, glass shade screws, and/or lightbulb(s). • Tighten the canopy screws and mounting plate assembly. Make sure the wire nuts inside the canopy and switch housing are not touching the metal parts and that they have not fallen off the wire splices. Tighten as necessary. • Tighten the blade holders to the flywheel (or direct drive motor) and the blades to the bladeholder screws. • Make sure all screws in the motor housing are snug but not overly tight.
Fan does not run on low speed	<ul style="list-style-type: none"> • If fan is new, it may need to be "broken in." Run at high speed for several days.
Battery life is short	<ul style="list-style-type: none"> • Replace with alkaline batteries.
Light works, but fan does not work	<ul style="list-style-type: none"> • The fan wires are not connected properly.
Fan and light run only on full speed	<ul style="list-style-type: none"> • The fan receiver is defective. Replace fan receiver.
Fan is missing one speed	<ul style="list-style-type: none"> • The fan receiver is defective. Replace fan receiver.
Fan does not change speed, but light works	<ul style="list-style-type: none"> • The fan receiver is defective. Replace fan receiver.
Reverse does not work	<ul style="list-style-type: none"> • The fan receiver is defective. Replace fan receiver.
Fan starts working by itself	<ul style="list-style-type: none"> • There is frequency interference.
Fan operates only when transmitter is close	<ul style="list-style-type: none"> • Check that antenna wire is not touching metal plate.
Fan works, but light does not dim	<ul style="list-style-type: none"> • The fan receiver is defective. Replace fan receiver.
Fan works, but light does not work	<ul style="list-style-type: none"> • The fan receiver is defective. Replace fan receiver. • The light socket is broken. Replace socket. • A lightbulb is defective. Replace lightbulb.

In compliance with US Federal Energy Regulations, this ceiling fan contains a device that restricts the light kit to a maximum of 190 watts. Exceeding that limit or the marked limit on this product may result in a fire hazard or improper operation.

CARE RECOMMENDATIONS

Fan Finishes

- For cleaning, a soft brush or lint-free cloth should be used to prevent scratching the finish.
- A vacuum cleaner brush nozzle can remove heavier dust.
- Surface smudges or an accumulation of dirt and dust can be removed easily by using a mild detergent and slightly dampened soft cloth. An antistatic agent may be used, but never use abrasive cleaning agents as these will damage the finish.

Blades

- Wood-finish blades should be cleaned with a furniture polishing cloth. Occasionally, a light coat of furniture polish may be applied for added protection and beauty.
- For painted and high-gloss blades, surface smudges or an accumulation of dirt and dust can be removed easily by using a mild detergent and slightly dampened soft cloth. An antistatic agent may be used, but never use abrasive cleaning agents as these will damage the finish.

No Need for Lubrication

- Never lubricate this fan! The precision motor at the heart of your Casablanca fan features sealed bearings that are lubricated for life.
- Do not attempt to oil the motor.

Changing Lightbulbs

- Be sure to turn the power to OFF at the wall switch or circuit breaker before changing lightbulbs.
- Replace bulbs with the same type as you removed from the light fixture.
- The maximum wattage rating for this fan's light kit is 100 watts. **Note: In compliance with US Federal Energy Regulations, this ceiling fan contains a device that restricts the light kit to a maximum of 190 watts. Exceeding that limit or the marked limit on this product may result in a fire hazard or improper operation.**

For questions or to locate the nearest Casablanca Authorized Service Center call toll free: 1-888-227-2178
or visit us on the web at: www.casablancafanco.com

This device complies with Part 15 of the FCC rules. Operation is subject to the following two conditions:

1. This device may not cause harmful interference.
2. This device must accept any interference received, including interference that may cause undesired operation.

This equipment has been tested and found to comply with the limits for a class B digital device, pursuant to Part 15 of the FCC rules. These limits are designed to provide reasonable protection against harmful interference in a residential installation. This equipment generates, uses, and can radiate radio frequency energy and, if not installed and used in accordance with the instructions, may cause harmful interference to radio communication. However, there is no guarantee that the interference will not occur in a particular installation. If this equipment does cause harmful interference to radio or television reception, which can be determined by turning the equipment off and on, the user is encouraged to try to correct the interference by one or more of the following measures:

- Reorient or relocate the receiving antenna.
- Increase the separation between the equipment and receiver.
- Connect the equipment into an outlet on a circuit different from that to which the receiver is connected.
- Consult the dealer or an experienced radio/TV technician for help.

NOTE: Any changes or modifications to the transmitter or receiver not expressly approved by Casablanca Fan Company may void one's authority to operate this remote control.



PRODUCT SPECIFICATIONS

Model Name: Vermont®
Model Number: C34GxxM

Dimensions: A = 9.7"
B = 13.7"
C = N/A"
D = N/A"
E = 15.4"

NOTE: Dimension B includes light fixture and glass.

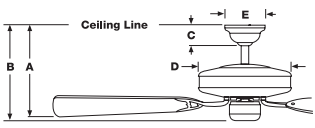

Weight: 35 lbs.

Motor: 188 x 20mm Direct Drive™
Blade Span: 54"
Blade Iron Pitch: 15°
No. of Blades: 5
Technology: Versa•Touch2® W-72
Lightbulb Type: (1) 100w Halogen

Airflow: 4,405 cfm
Electricity Use*: 83 watts
Airflow Efficiency: 53 cfm/watt

* Performance data is for fan only. No lighting wattage is included.

Free Manuals Download Website

<http://myh66.com>

<http://usermanuals.us>

<http://www.somanuals.com>

<http://www.4manuals.cc>

<http://www.manual-lib.com>

<http://www.404manual.com>

<http://www.luxmanual.com>

<http://aubethermostatmanual.com>

Golf course search by state

<http://golfingnear.com>

Email search by domain

<http://emailbydomain.com>

Auto manuals search

<http://auto.somanuals.com>

TV manuals search

<http://tv.somanuals.com>