

Vestax
CD MIXING CONSOLE
CDX-16

OWNER'S MANUAL

VESTAX CORPORATION

1-18-6 Wakabayashi, Setagaya-Ku, Tokyo JAPAN 154-0023
Phone:03-3412-7011 Fax:03-3412-7013
<http://www.vestax.com>

VESTAX EUROPE

Unit 5 Riverway Industrial Park, Alton Hampshire GU34 2QL ENGLAND
Phone:04120-83000 Fax:04120-80040
<http://www.vestax.co.uk>

CONGRATULATIONS !

Thank you for purchasing the Vestax CDX-16 CD Mixing Console. We suggest that you read through this owner's manual thoroughly so that you may enjoy the full use of this product safely and in the knowledge of all its special features and suitable applications.

CONTENTS

CAUTION	2
IMPORTANT SAFEGUARDS	4
FEATURES	5
BEFORE USE	6
FUNCTION	6
CD SECTION	7
MIXER SECTION	11
FRONT PANEL	11
REAR PANEL	12
CONNECTION EXAMPLE	12
GETTING THE MOST OUT OF THE CDX-16	13
SPECIFICATIONS	14



CAUTION

RISK OF ELECTRIC SHOCK DO NOT OPEN



CAUTION : TO REDUCE THE RISK OF ELECTRIC SHOCK
DO NOT REMOVE COVER (OR BACK)
NO USER-SERVICEABLE PARTS INSIDE
REFER SERVICING TO QUALIFIED SERVICE PERSONNEL



The lightning flash with arrowhead symbol, within an equilateral triangle, is intended to alert the user to the presence of uninsulated "dangerous voltage" within the product's enclosure that may be of sufficient magnitude to constitute a risk of electric shock to persons.



The exclamation point within an equilateral triangle is intended to alert the user to the presence of important operating and maintenance (servicing) instructions in the literature accompanying the appliance.

TO REDUCE THE RISK OF FIRE OR ELECTRIC SHOCK, DO NOT EXPOSE THIS APPLIANCE TO RAIN OR MOISTURE.

CAUTION : TO PREVENT ELECTRIC SHOCK, MATCH BLADE OF PLUG TO WIDE SLOT, FULLY INSERT

ATTENTION : POUR EVITER LES CHOCs ELECTRIQUES, INTRODUIRE LA LAME LA PLUS LARGE DE LA FICHE DANS LA BORNE CORRESPONDANTE DE LA PRISE ET POUSSER JUSQU' AU FOND

NOTE

This equipment has been tested and found to comply with the limits for a Class B digital device, pursuant to Part 15 of the FCC Rules. These limits are designed to provide reasonable protection against harmful interference in a residential installation. This equipment generates, uses and can radiate radio frequency energy and, if not installed and used in accordance with the Instructions, may cause harmful interference to radio communications. However, there is no guarantee that interference will not occur in a particular installation. If this equipment does cause harmful interference to radio or television reception, which can be determined by turning the equipment off and on, the user is encouraged to try to correct the interference by one or more of the following measures.

Reorient or relocate the receiving antenna.

Increase the separation between the equipment and receiver.

Connect the equipment into an outlet on a circuit different from that to which the receiver is connected.

Consult the dealer or an experienced radio/TV technician for help.

NOTE

Changes or modifications may cause this unit to fail to comply with Part 15 of the FCC Rules and may void the user's authority to operate the equipment.

This Class B digital apparatus meets all requirements of the Canadian Interference-Causing Equipment Regulations.

Cet appareil numérique de la Classe B respecte toutes les exigences du Règlement sur le matériel brouilleur du Canada.

IMPORTANT

This apparatus is fitted with an approved moulded 13 Amp plug. To change a fuse in this type of plug proceed as follows:

1. Remove fuse cover and fuse.
2. Fix new fuse which should be a BS1362 5A. A.S.T.A. or BSI approved type.
3. Refit the fuse cover.

If the fitted plug is not suitable for your socket outlets, it should be cut off and an appropriate plug fitted in its place. If the mains plug contains a fuse, this should have a value of 5A. If a plug without a fuse is used, the fuse at the distribution board should not be greater than 5A.

NOTE

The severed plug must be destroyed to avoid a possible shock hazard it be inserted into a 13A socket elsewhere.

HOW TO CONNECT A PLUG

The wires in the mains lead are coloured in accordance with the following code:

BLUE-"NEUTRAL"("N")

BROWN-"LIVE"("L")

1. The BLUE wire must be connected to the terminal which is marked with the letter "N" or coloured BLACK.
2. The BROWN wire must be connected to the terminal which is marked with the letter "L" or coloured RED.
3. Do not connect either wires to the earth terminal in the plug which is marked by the letter "E" or by the safety earth symbol or coloured green or green-and-yellow.

Before replacing the plug cover, make certain that the cord grip is clamped over the sheath of the lead-not simply over the two wires.

**CLASS 1 LASER PRODUCT
LUOKAN 1 LASERLÄITE KLASS 1
LASERAPPARAT**

IMPORTANT SAFEGUARDS

READ BEFORE OPERATING EQUIPMENT

This product was designed and manufactured to meet strict quality and safety standards. There are, however, some installation and operation precautions which you should be particularly aware of.

1. Read instructions-All the safety and operating instructions should be read before the appliance is operated.
2. Retain instructions-The safety and operating instructions should be retained for future reference.
3. Heed Warnings-All warnings on the appliance and in the operating instructions should be adhered to.
4. Follow Instructions-All operating and use instructions should be followed.
5. Cleaning-Unplug this product from the wall outlet before cleaning. Do not use liquid cleaners or aerosol cleaners. Use a damp cloth for cleaning.
6. Attachments-Do not use attachments not recommended by the product manufacturer as they may cause hazards.
7. Water and Moisture-Do not use this product near water-for example, near a bath tub, wash bowl, kitchen sink, or laundry tub, in a wet basement, or near a swimming pool, and the like.
8. Accessories-Do not place this product on an unstable cart, stand, tripod, or table. The product may fall, causing serious injury to a child or adult, and serious damage to the appliance. Use only with a cart, stand, tripod, bracket, or table recommended by the manufacturer, or sold with product. Any mounting of the appliance should follow the manufacturer's instructions, and should use a mounting accessory recommended by the manufacturer.
9. Ventilation-Slots and openings in the cabinet are provided for ventilation and to ensure reliable operation of the product and to protect it from overheating, and these openings must not be blocked or covered. The openings should never be blocked by placing the product on a bed, sofa, rug, or other similar surface. This product should never be placed near or over a radiator or heat register. This product should not be placed in a built-in installation such as a bookcase or rack unless proper ventilation is provided or the manufacturer's instructions have been adhered to.
10. Power sources-This product should be operated only from the type of power source indicated on the marking label. If you are not sure of the type of power supply to your home, consult your appliance dealer or local power company.
11. Grounding or Polarization-This product is equipped with a polarized alternating-current line plug (a plug having one blade wider than the other). This plug will fit into the power outlet only one way. This is a safety feature. If you are unable to insert the plug fully into the outlet, try reversing the plug. If this should still fail to fit, contact your electrician to replace your obsolete outlet. Do not defeat the safety purpose of the polarized plug.
12. Power-Cord Protection-Power supply cords should be routed so that they are not likely to be walked on or pinched by items placed upon or against them, paying particular attention to cords at plugs, convenience receptacles, and the point where they exit from the appliance.
13. Protective Attachment Plug-The appliance is equipped with an attachment plug having overload protection. This is a safety feature. See Instruction Manual for replacement or resetting of protective device. If replacement of the plug is required, be sure the service technician has used a replacement plug specified by the manufacturer that has the same overload protection as the original plug.
14. Lightning-For added protection for this product during lightning storm, or when it is left unattended and unused for long periods of time, unplug it from the wall outlet. This will prevent damage to the product due to lightning and power-line surges.
15. Overloading-Do not overload wall outlets and extension cords as this can result in a risk of fire or electric shock.
16. Object and Liquid Entry-Never push objects of any kind into this product through openings as they may touch dangerous voltage points or short-out parts that could result in a fire or electric shock. Never spill liquid of any kind on the product.

17. Servicing-Do not attempt to service product yourself as opening or removing covers may expose you to dangerous voltage or other hazards. Refer all servicing to qualified personnel.
18. Damage Requiring Service-Unplug this product from the wall outlet and refer servicing to qualified service personnel under the following conditions:
 - a. When the power-supply cord or plug is damaged.
 - b. If liquid has been spilled or objects have fallen into the product.
 - c. If the product has been exposed to rain or water.
 - d. If the product does not operate normally by following the operating instructions. Adjust only those controls that are covered by the operating instructions as an improper adjustment of other controls may result in damage and will often require extensive work by a qualified technician to restore the product to its normal operation.
 - e. If the product has been dropped or cabinet has been damaged.
 - f. When the product exhibits a distinct change in performance-this indicates need for service.
19. Replacement Parts-When replacement parts are required, be sure the service technician has used replacement parts specified by the manufacturer or have the same characteristics as the original parts. Unauthorized substitutions may result in fire, electric shock or other hazards.
20. Safety Check-Upon completion of any service or repairs to product, ask the service technician to perform safety checks to determine that the product is in proper operating condition.
21. Carts and Stands-The appliance should be used only with a cart stand that is recommended by manufacturer.
22. An appliance and cart combination should be moved with care. Quick stops, excessive force, and uneven surfaces may cause the appliance and cart combination to overturn.



FEATURES

Dual Top loading CD player. For quick loading of CDs top loading systems offer unparalleled ease. Further, the opaque plastic cover allows you to visualize the current playing status of the unit unlike front-loading players.

Inbuilt mixer. The CDX-16's inbuilt mixer allows you to mix CD, phono, and line sources without the connection of an external mixing console. To choose the input source or CD which will be mixed, simply switch to the desired input using the input assign switch.

Pitch Control. The playing pitch of either CD can be adjusted with the use of the pitch control fader or the pitch may be bent with the pitch bend joystick. The pitch range can be set to two levels, +/-8 or +/-16. Pitch range is most useful when attempting to best match the playing pitch of one track with another for smooth beat mixing.

Joystick. The two (2) joysticks on the CDX-16 allow users to quickly scan the CD, search easily for a known track and to pitch bend the track playing. Pitch bend allows you to adjust to pitch momentarily in order to fine tune your mix.

Auto Smoothing. Between each track on any CD is usually a few seconds of no signal. The CDX-16 incorporates technology that eliminates this "blankness" with the result being a smooth blend from the previous track to the current track playing.

Anti Skip & Anti Jump. The buffer memory on the CDX-16 is sufficient to eliminate any skipping from vibrations or pressure. The suspension system also prevents low frequency sounds from causing similar skips or jumps whilst the CD is playing.

Cue Point. This function allows you to set a cue point on a given CD and to access this point quickly and easily.

Standby Mode. If the CD is left unattended or on pause mode for an extended period (approximately 10 minutes) the unit will go into sleep/auto standby mode. This feature has been included to promote the life of each mechanism as constant playing will wear down the quality of the laser and reduce the amount of enjoyment that you may have with the CDX-16.

BEFORE USE

Using CDs.

A conventional CD consists of two (2) sides. Typically one side bears a label stating the name of the CD and artist whilst the front side, rainbow like in its color, contains the information that makes this technology work. There are approximately six (6) million data items stored on any one given CD front surface. Please make sure to load the CD into the playing mechanism correctly, so that the front side (rainbow) is unable to be seen once the lid is closed.

Unlike conventional analog turntables, CD technology uses a fine laser beam instead of a stylus to read the contents of the disc. As a result of there being little physical contact, a CD will take infinitely longer to degrade. Repeated use of a CD, even playing over the same track again and again will likely have very little effect on the audible quality of the discs data.

However, the front surface of a CD is brittle and may be scratched or damaged if you are careless in its handling. Thus, please take care to load you CDs correctly and ensure that you store them in a safe place. Furthermore, avoid leaving CDs in direct sunlight or in close proximity to a heating device or hot object, in the rain or in water, or on surfaces that have excessive moisture or surface dirt/grime. Also take care when cleaning any CD by using a recommended or special purpose cleaning cloth, cleaning spray or product and always wipe in the direction illustrated below.

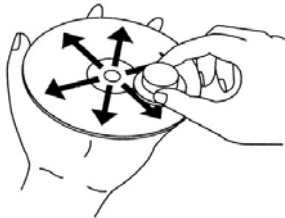

Wipe from the inside out.

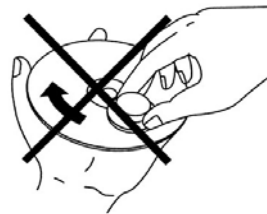

Do not wipe in a circular fashion.

Never use record cleaner designed for conventional analog disks, this will degrade the CD disc surface.

Always store disc properly in the case.

Warning

- Please do not inhibit access to this unit's main switch by operating it in a confined area.
- Do not expose to water, moist environments or operate this device in an area likely to be effected by liquid spillage or dripping.

FUNCTIONS

TOP

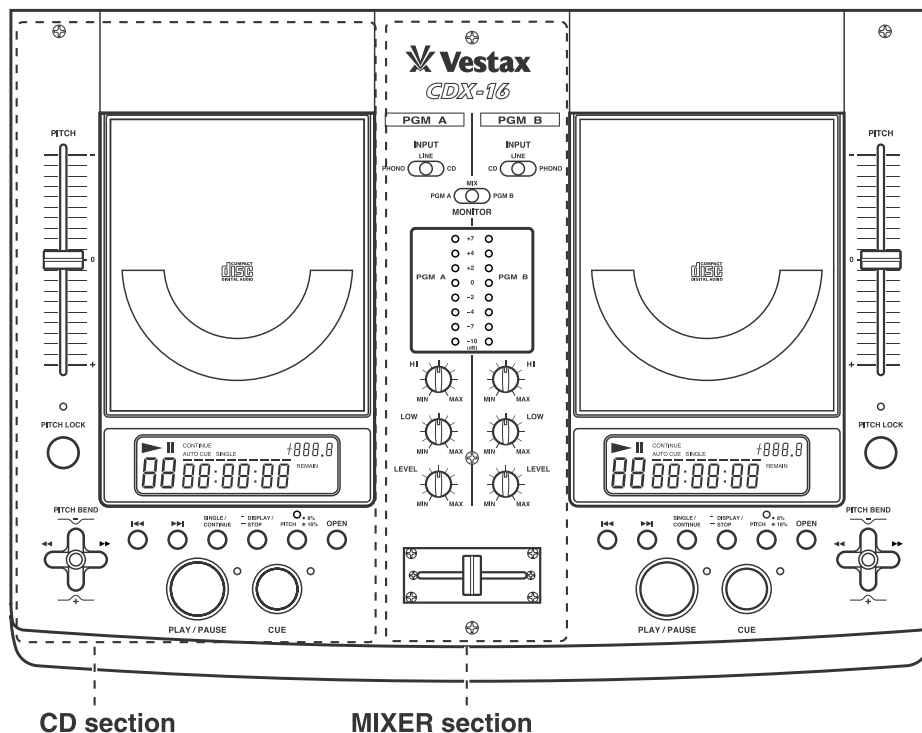

CD section

MIXER section

CD SECTION

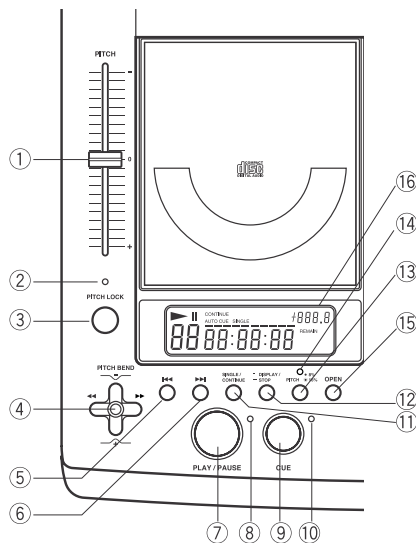

PITCH CONTROL FADER

Used to adjust the playing pitch (speed) by up to +/- 8%, +/- 16%. As this fader is 100mm in length you are able to make both major and subtle adjustments in the playing pitch of any given CD sound source. Typically, this fader is used to make subtle adjustments that allow for beat matching/mixing that results in you ultimately being able to move from one track to another without an audible difference.

PITCH LOCK INDICATOR

When the light is on Pitch Lock is active. When the light is off Pitch Lock is inactive.

PITCH LOCK ON/OFF SWITCH

When selected, and the light is on, the pitch of the CD playing will be set to a pitch neutral position regardless of the pre-set pitch level or how the pitch control fader is adjusted. When Pitch Lock is set to off, the pitch control fader is active.

STICK CONTROLLER

[1] Pitch Bend

By pressing the stick towards the rear panel (up) of the console you are able to make a momentary negative (-) adjustment in the pitch. The opposite movement (down) will result in a positive (+) adjustment in the pitch. The joystick will automatically spring back to a neutral position and any pitch adjustments will hence stop. You can use this feature to give the track a little push or a little pull or you can use it to create some interesting effects.

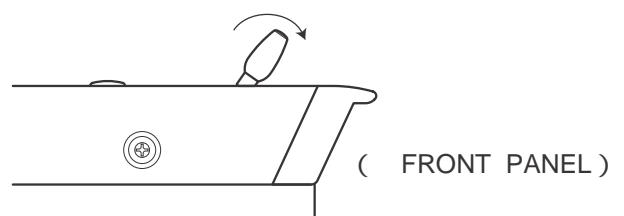

stick up The pitch (speed) decreases by up to -20%

stick down The pitch (speed) increases by up to +20%

[2] Scan Function

Whilst the CD is in play mode pressing the joystick to the left will scan the CD in reverse whilst pressing the joystick to the right will scan forward. This speed setting is dependent on the angle of the joystick. The flatter the angle the faster the scan speed and vice versa. The scan function is easily used to find an approximate starting point on a track

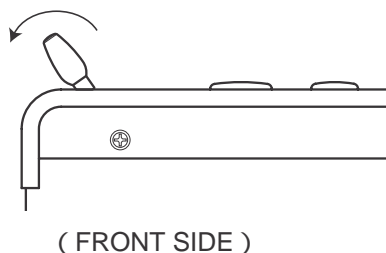

stick left Scans backward.

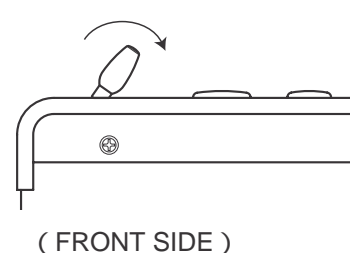

stick right Scans forward.

[3] Search Function

Whilst pause is activated, the joystick when moved from left to right will do so in 1-75 frame units for the purpose of aiding track or point search. This is especially useful when recalling an exact start point far from the start or end point or a particular track.

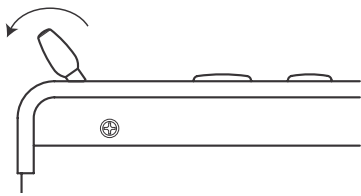

stick left Scans backward.

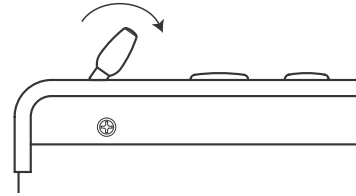

stick right Scans forward.

The information (data) on a CD is written at approximately 75 frames per second.

PREVIOUS BUTTON

Used for skipping backwards to the starting point of the current track (when pressed once). If pressed twice, the return point is the starting point of the previous track. The number of times this button is pressed (after the first time) corresponds to the number of tracks back the starting point returns to.

NEXT BUTTON

Used for skipping forward to the starting point of the next track. The number of times pressed determines the number of tracks skipped ahead.

PLAY/PAUSE BUTTON

Press this button to play a given track on the CD or to pause at any point on any track. Whilst in pause mode, the CD will continue to spin but the point at which you pressed pause will be the starting point for when you choose to push play.

PLAY/PAUSE INDICATOR

This light indicates whether or not the unit is in play or in pause mode. When the light is on, the CD is in play mode. If the indicator light is flashing then the CD is in pause mode.

CUE BUTTON

The last pause point is always memorized and can be cued up by pressing the cue button. This function is useful for instant cueing as the same position (pause point) can be recalled and played back with one easy action.

A Cue Point will be lost when,

The unit is turned off.

The CD is played or the pause point is shifted. The new cue point will always be the point at which pause was last set.

The stop button is pressed.

The applicable CD is ejected.

(A) Using the Cue function.

To set a cue point is simple and easy. Once you have found the section or point, which you want to cue press the pause button. To check if your cue point is OK, hold down the cue button and the track will play past this point. Release the cue button and the initial point from which you just played will be recalled. When it comes time to play from the cue point first press the cue button to make sure that the point is recalled and set and then press the play/pause button. Please note that unless you press pause again, the cue point will remain at the first point set.

CUE INDICATOR

When the cue point is set the LED will be on.

SINGLE / CONTINUE BUTTON

This button is used to switch between single play, single repeat and all repeat modes.

When the unit is first switched on this mode will be set to OFF, meaning that at the end of the CD's final track the CD will stop. Press the single/continue button once and the AUTO CUE SINGLE mode will be selected. Set to this mode the current track will be repeated until it is stopped. Press the single/continue button twice (once more) and the CONTINUE mode will be selected. In this mode the entire CD will be repeated upon the conclusion of the final track until it is stopped.

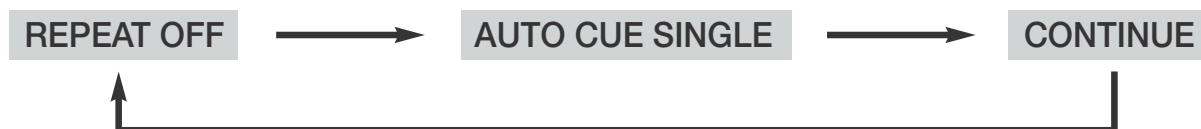

DISPLAY / STOP BUTTON

When pressed the time indicated on the display will change to display;

Single remain (time remaining until conclusion of the current track).

Single elapse (time elapsed on the current track).

Total remain (time remaining until the conclusion of the final track of the CD).

***If the Display / Stop button is held for more than three (3) seconds the player will go into sleep mode. This is especially useful in preventing the premature degradation of the units laser. The unit will automatically go into sleep mode after approximately 10 minutes of inactive use.

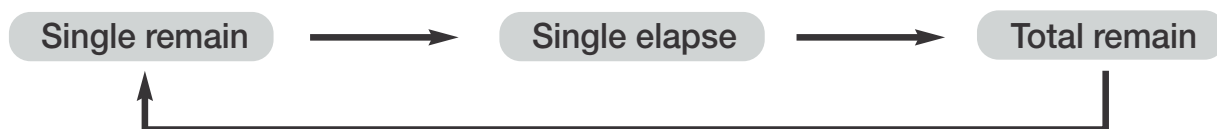

PITCH RANGE ASSIGN SWITCH

This switch changes the pitch range from +/- 8% to +/- 16%.

PITCH RANGE INDICATOR

Indicates the current pitch range selection.

OPEN BUTTON

Used to open the unit for easy access to the CD. As an inbuilt safety mechanism for top loading drives, a CD can not be ejected until the mechanism has been stopped.

DISPLAY

[1] Indication of motion status

Display	Status
Open	The top loading CD tray is open.
Read	The CD mechanism is reading the TOC data from the CD.
No Disc	The CD tray is closed and there is no disc or the disc has a reading error.
Sleep	The CD mechanism/motor has been stopped.

[2] DISPLAY

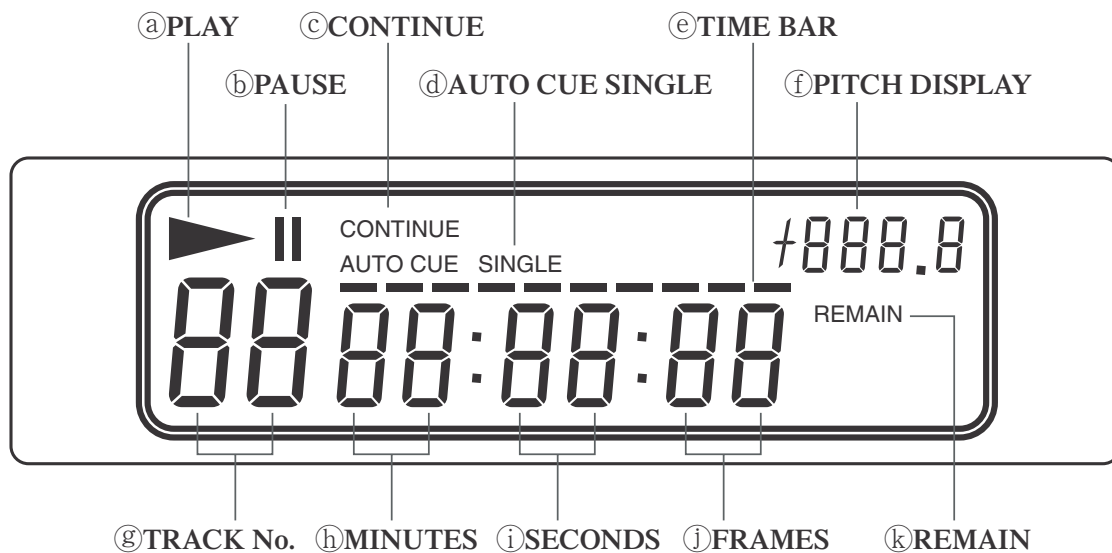

(a) PLAY	The CD is in play mode.
(b) PAUSE	The CD is in pause mode.
(c) CONTINUE	The entire CD will be repeated upon the conclusion of the final track.
(d) AUTO CUE SINGLE	The current track will be repeated.
(e) TIME BAR	This bar indicates the time remaining or elapsed (depending on the display mode setting).
(f) PITCH DISPLAY	Displays the current pitch setting.
(g) TRACK No.	Current track number playing or on pause.
(h) MINUTES	Shows minute(s) respective to the display mode setting.
(i) SECONDS	Shows second(s) respective to the display mode setting.
(j) FRAMES	Shows the frame(s) respective to the display mode setting.
(k) REMAIN	Displays the current setting for the Display/Stop button.

MIXER SECTION

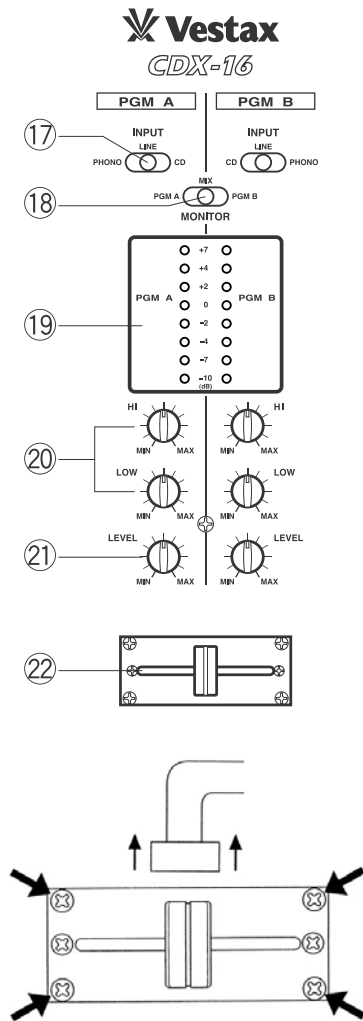

INPUT SELECT SWITCH

Used to select the input source (Phono, Line, CD) sent to the designated PGM (A,B).

MONITOR SELECT SWITCH

Used to select the signal for monitoring (headphone). Selection is made irrespective of the position of the crossfader and can be set to either PGM A, B or to Mix. The selected PGM monitor signal can be heard through the left (side) headphone whilst the main output signal is heard in the right headphone. When set to MIX the master signal can be monitored through both headphones in stereo.

INPUT LEVEL METER

This LED indicates the current level of each input signal for both PGM A and PGM B.

PGM EQ VOLUME

Used to adjust the EQ, Hi (high) Lo (low) frequencies for each PGM.

21 PGM VOLUME LEVEL

Used to control and adjust the input level of each PGM.

22 CROSS FADER

With the cross fader to the left, the output signal is PGM A. Therefore, when the cross fader is to the right the output signal is PGM B. As the cross fader is moved from one side to the other there is a blend of the respective signals. This is such that when the fader is in the neutral (center) position both signals can be heard. The cross fader on the CDX-16 is user replaceable. When the cross fader is worn out the fader may be easily removed and subsequently replaced with the optional replacement fader CF-R3 Likewise, preventative maintenance & cleaning of the fader may be accomplished through such easy removal.

To replace the crossfader please follow the below instructions carefully.

- (i) Carefully remove the four (4) screws that fix the crossfader to the faceplate.
- (ii) Gently remove the crossfader, making sure to disconnect all cables carefully.
- (iii) Replace the crossfader unit, making sure to carefully connect all cables to their proper points.
- (iv) Affix the crossfader unit to the faceplate with the previously removed four (4) screws.

FRONT PANEL

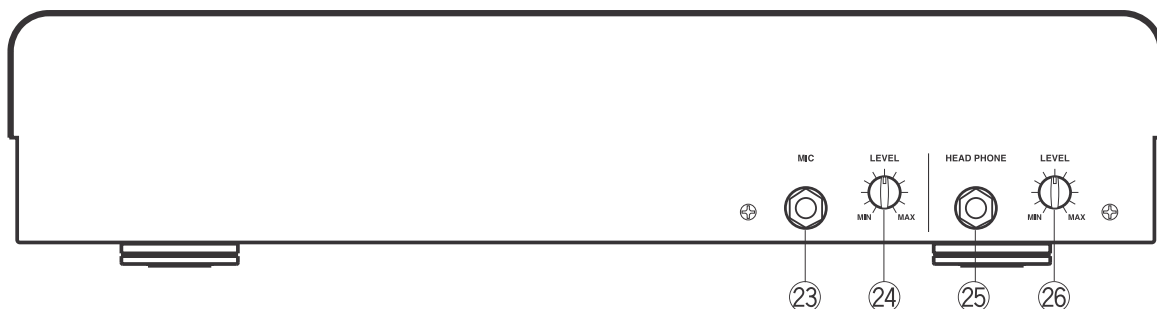

23 MIC INPUT JACK

Input jack for MIC.

24 MIC VOLUME LEVEL

Used to control and adjust the level of the MIC input.

25 HEADPHONE JACK

Input jack for MIC.

26 MONITOR VOLUME LEVEL

Used to control and adjust the volume level of the monitor (headphones).

REAR PANEL

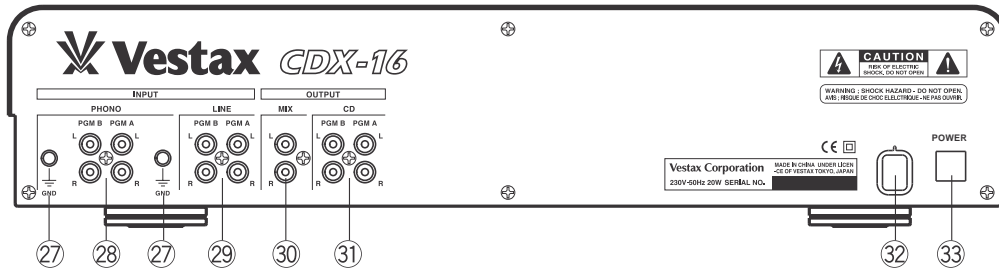

27 GROUND (GND) TERMINAL

Connection of this terminal to the grounding out lead of a turntable will reduce unnecessary hum and noise.

28 PHONO INPUT JACK

Used to connect a turntable (MM moving magnet type) to the CDX-16 unit. The signal from the turntable is sent to the PGM channels when the phono input is selected.

29 LINE INPUT JACK

CD, MD, DAT, TAPE or other like playing equipment (-10dB - 0dB play levels) may be connected through the line jacks. The respective signal is then sent through to either PGM when the line input is selected.

30 MIX OUTPUT JACK

Used for the connection to a power amplifier.

31 CD OUTPUT JACK

Each connection allows the output signal of each CD player to be sent to an external unit. None of the mixer features will affect the output signal when this connection is used.

32 AC POWER CORD

33 POWER ON/OFF SWITCH

Please check that the volume level of a connected power amplifier is at its minimum position prior to turning the CDX-16 unit either on or off.

CONNECTION EXAMPLE

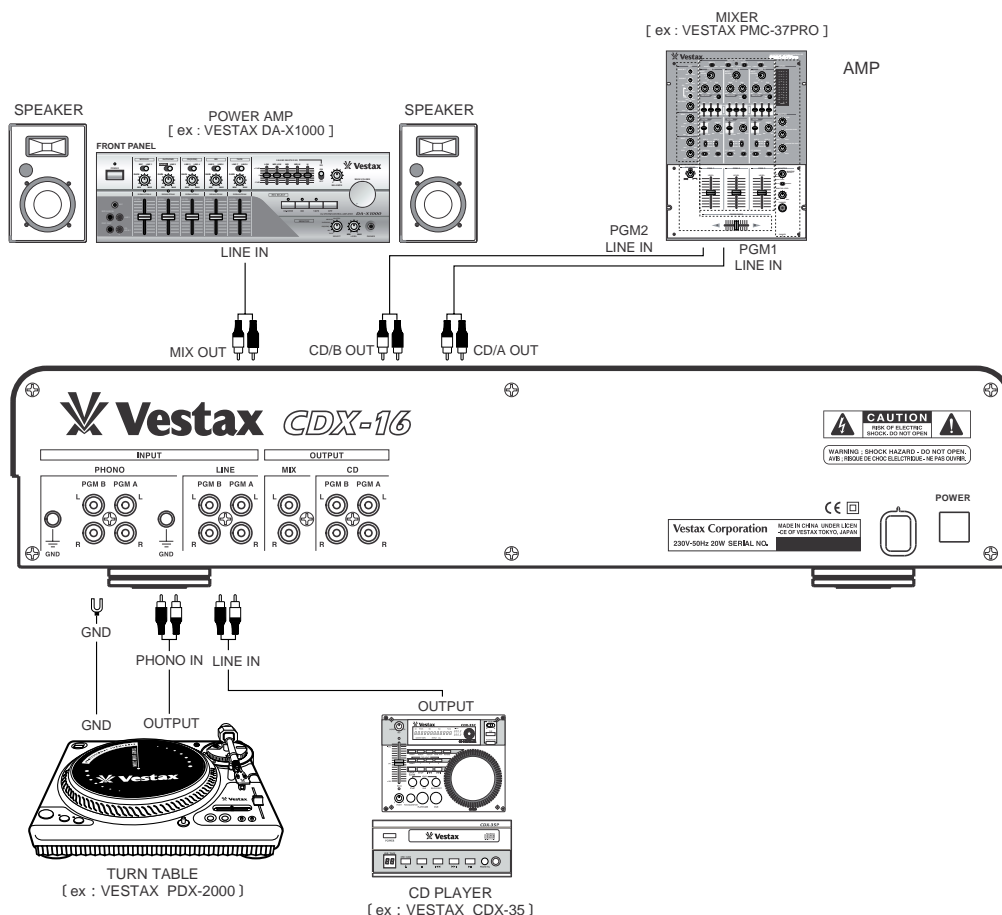

GETTING THE MOST OUT OF THE CDX-16

1. Switch your CDX-16 on, you'll find the on/off switch on the left side of the rear panel.
2. Open the CD tray(s) and put in your CD. Make sure that the CD has been placed flat and in the tray with the front side facing the mechanism (so that you can see the label side through the tray's window. Close the tray
3. Press the PLAY button.
4. The CD will now be playing and you will be able to fully control the CD's status through all the various controls. For example if you want to skip ahead to track number 5 and to cue up to start at 01.30.00, use the NEXT button to first get you to track number 5. Set the CD to PAUSE and then use the joystick controller to search ahead to the 01.30.00 mark. Press the PLAY button to start playing from that point. Alternatively, once you have gotten to track number 5 simply use the joystick to scan through to approximately 01.25.00 and then release the joystick. If you press the PAUSE button at precisely 01.30.00 you will have set yourself a CUE point that you can recall at anytime, regardless of the tracks playing status. From this CUE point simply press the PLAY button to continue.
5. Now that you have mastered the playing functions you may wish to turn your attention to improving your DJ mixing skills. With both CD units active you can easily mix between either CD 1 or CD 2. Depending on your monitoring setting is what you will hear. Please play around with this feature until you have confidently become accustomed to cuing you tracks up with another playing. To mix between the CDs playing is simple with the crossfader. Of course, with great input options you can also cue up an external source.
6. When you have finished your session be sure to turn your CDX-16 off in order to prevent unnecessary degradation to your CD mechanisms. To do this just hold down the STOP button for longer than three seconds. Please check that you have stopped both CD1 and CD2 before turning your CDX-16 off at the power switch.

SPECIFICATIONS

Total Power requirement	115V/230V AC, 35W
Weight	6.8kg
Dimensions (W × H × D)	441 × 321 × 126 (mm)

CD SECTION

Quantization	16bit liner
Sampling Frequency	44.1kHz
Digital Filter	8 times over sampling
Shock Proof Memory	16Mbit, 10sec
Error Correcting System	CIRC
Harmonic Distortion	Less than 0.03%
Frequency response	20Hz ~ 20kHz ± 2dB
Signal To Noise Ratio	More than 85dB
Channel Separation	More than 80dB
CD OUT	2Vrms
Mechanism Mount	Magnetic chucking top mount CD mechanism

MIXER SECTION

Frequency Response	20Hz ~ 20kHz ± 2dB (MIX OUT)
Cross Talk	60dB
Signal To Noise Ratio	75dB
Headphone Level	1.4Vrms (32ohm Load)



Free Manuals Download Website

<http://myh66.com>

<http://usermanuals.us>

<http://www.somanuals.com>

<http://www.4manuals.cc>

<http://www.manual-lib.com>

<http://www.404manual.com>

<http://www.luxmanual.com>

<http://aubethermostatmanual.com>

Golf course search by state

<http://golfingnear.com>

Email search by domain

<http://emailbydomain.com>

Auto manuals search

<http://auto.somanuals.com>

TV manuals search

<http://tv.somanuals.com>