



Professional Mixing Controller

PMC-05Pro III

OWNER'S MANUAL

Vestax Corporation

1-18-6 Wakabayashi, Setagaya-ku, Tokyo 154-0023 Japan
Phone 03-3412-7011 Fax 03-3412-7013
Web : www.vestax.com

Vestax (Europe) Ltd.

Unit 5 Riverway Industrial Park Alton Hampshire GU34 2QL England, U.K.
Phone (0)1420-83000 Fax (0)1420-80040
Web : www.vestax.co.uk

Vestax Europe Technical Support

Rheinstr.213 D-53332 Bornheim Germany
Phone 49(0)2222-95-23-72 Fax 49(0)2222-95-23-74

CONGRATULATIONS!

Thank you for your purchasing the VESTAX PMC-05ProIII, Professional Mixing Controller. We suggest that you read through this owner's manual thoroughly so that you may enjoy the full use of this product safely and in the knowledge of all its special features and suitable applications.

CONTENTS

C A U T I O N	2
IMPORTANT SAFEGUARDS	3
F E A T U R E S	4
F U N C T I O N	5
T O P P A N E L	5
F R O N T P A N E L	7
R E A R P A N E L	7
HOW TO CHANGE THE FADER UNIT	8
C O N N E C T I O N	10
S P E C I F I C A T I O N S	11

	CAUTION RISK OF ELECTRIC SHOCK DO NOT OPEN	
CAUTION : TO REDUCE THE RISK OF ELECTRIC SHOCK DO NOT REMOVE COVER (OR BACK) NO USER-SERVICEABLE PARTS INSIDE REFER SERVICING TO QUALIFIED SERVICE PERSONNEL		



The lightning flash with arrowhead symbol , within an equilateral triangle , is intended to alert the user to the presence of uninsulated " dangerous voltage " within the product's enclosure that may be of sufficient magnitude to constitute a risk of electric shock to persons .



The exclamation point within an equilateral triangle is intended to alert the user to the presence of important operating and maintenance (servicing) instructions in the literature accompanying the appliance .

TO REDUCE THE RISK OF FIRE OR ELECTRIC SHOCK , DO NOT EXPOSE THIS APPLIANCE TO RAIN OR MOISTURE .

IMPORTANT SAFEGUARDS

READ BEFORE OPERATING EQUIPMENT

This product was designed and manufactured to meet strict quality and safety standards. There are, however, some installation and operation precautions which you should be particularly aware of.

1. Read instructions-All the safety and operating instructions should be read before the appliance is operated.
2. Retain instructions-The safety and operating instructions should be retained for future reference.
3. Heed Warnings-All warnings on the appliance and in the operating instructions should be adhered to.
4. Follow Instructions-All operating and use instructions should be followed.
5. Cleaning-Do not use liquid cleaners or aerosol cleaners. Use a damp cloth for cleaning.
6. Attachments-Do not use attachments not recommended by the product manufacturer as they may cause hazards.
7. Water and Moisture-Do not use this product near water-for example, near a bath tub, wash bowl, kitchen sink, or laundry tub, in a wet basement, or near a swimming pool, and the like.
8. Accessories-Do not place this product on an unstable cart, stand, tripod, or table. The product may fall, causing serious injury to a child or adult, and serious damage to the appliance. Use only with a cart, stand, tripod, bracket, or table recommended by the manufacturer, or sold with product. Any mounting of the appliance should follow the manufacturer's instructions, and should use a mounting accessory recommended by the manufacturer.
9. This product should never be placed near or over a radiator or heat register. This product should not be placed in a built-in installation such as a bookcase or rack unless proper ventilation is provided or the manufacturer's instructions have been adhered to.
10. Power sources-This product should be operated only from the type of power source indicated on the marking label. If you are not sure of the type of power supply to your home, consult your appliance dealer or local power company.
11. Lightning-For added protection for this product during lightning storm, or when it is left unattended and unused for long periods of time, unplug it from the wall outlet. This will prevent damage to the product due to lightning and power-line surges.
12. Overloading-Do not overload wall outlets and extension cords as this can result in a risk of fire or electric shock.
13. Object and Liquid Entry-Never push objects of any kind into this product through openings as they may touch dangerous voltage points or short-out parts that could result in a fire or electric shock. Never spill liquid of any kind on the product.
14. Servicing-Do not attempt to service product yourself as opening or removing covers may expose you to dangerous voltage or other hazards. Refer all servicing to qualified personnel.
15. Damage Requiring Service-Unplug this product from the wall outlet and refer servicing to qualified service personnel under the following conditions:
 - a. When the power-supply cord or plug is damaged.
 - b. If liquid has been spilled or objects have fallen into the product.
 - c. If the product has been exposed to rain or water.
 - d. If the product does not operate normally by following the operating instructions. Adjust only those controls that are covered by the operating instructions as an improper adjustment of other, controls may result in damage and will often require extensive work by a qualified technician to restore the product to its normal operation.
 - e. If the product has been dropped or cabinet has been damaged.
 - f. When the product exhibits a distinct change in performance-this indicates need for service.

16. Replacement Parts-When replacement parts are required, be sure the service technician has used replacement parts specified by the manufacturer or have the same characteristics as the original parts. Unauthorized substitutions may result in fire, electric shock or other hazards.
17. Safety Check-Upon completion of any service or repairs to product, ask the service technician to perform safety checks to determine that the product is in proper operating condition.
18. Carts and Stands-The appliance should be used only with a cart stand that is recommended by manufacturer.
19. An appliance and cart combination should be moved with care. Quick stops, excessive force, and uneven surfaces may cause the appliance and cart combination to overturn.



NEW FEATURES & FEATURES THAT VESTAX MADE STANDARD

NEW

- Effects routing. 1 x Effects Send and 1 x Effects Receive means that you can hook up an external effects unit for use during play. The volume of your send and receive signal is easily controlled through 2 x volume knobs and the signal can be sent to PGM1, PGM2 or both simultaneously.
- New PCV Cross Fader. The new PMC-05ProIII comes standard with Vestax's latest proprietary cross fader. Extra smooth, fast and amazingly precise, this plastic conductive volume fader is built to last and survive the most intense play possible.
- New Input Switch. Designed for rugged and fast use, this new input switch will stand up to just about any punishment and is designed to allow quick and constant changing between phono and line inputs. It is also omni positional meaning that you can have it set to its standard position or a number of angles it for easy use.
- New Look. The new PMC-05ProIII has not only undergone a technology upgrade but it also sports a new look with a new set of rotary knobs. These new knobs are built to reduce slippage and improve fast access at all times.
- Monitor Cue. Select between monitoring the cue signal or the master signal. Great for practice and live play.
- Improved EQ specifications. The EQ section on the PMC-05ProIII has an improved frequency response of -26dB to +6dB.

FEATURES THAT VESTAX MADE STANDARD

- Double Panel. Vestax invented the double panel system in order to open up the faceplate for fast moves and reduce personal injury (fingernails). This full battle worthy layout was designed with a lot of advice from top-level scratch and performance DJs and has become the layout standard for scratch and performance mixers since.
- User Replaceable Parts. It is a given that you will punish your mixer enough to need to replace the cross fader, an input fader and possibly the input select switch. Thus, Vestax came up with the concept of user replaceable parts. You can easily replace and or upgrade the faders and the input switches on the PMC-05Pro series by yourself in just a few minutes.
- Cross Fader Curve Control. Vestax faders have an undeniably great feel about them. They are smooth, responsive and strong enough to withstand most punishment. But making them even more performance friendly is that the curve of the fader can be preset or adjusted to suit your playing style.

FUNCTIONS

TOP PANEL

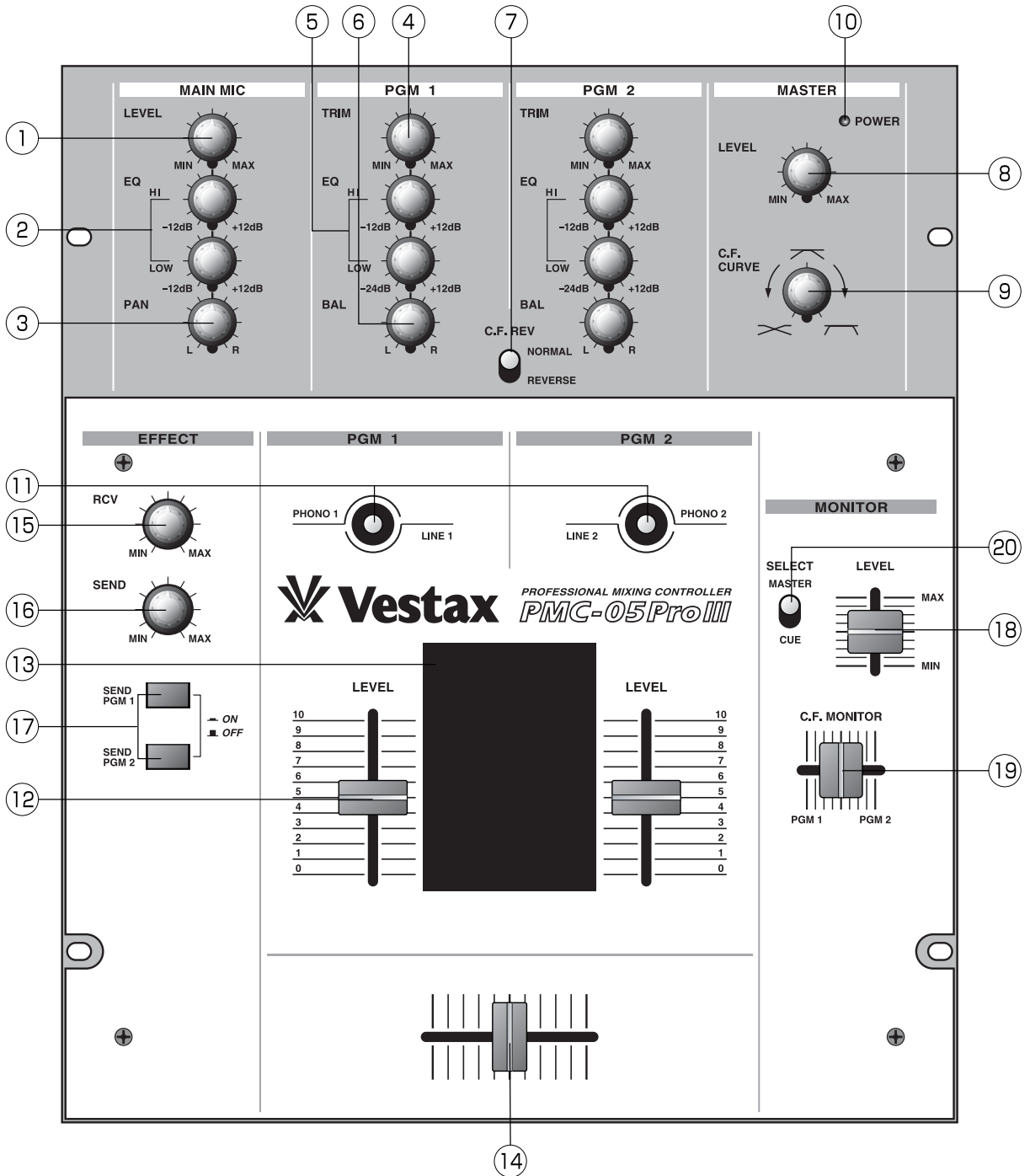

① **MAIN MIC LEVEL**

Adjusts the input level of the MAIN MIC input.

② **MIC EQs**

Adjusts the HI and LOW frequencies for both the MAIN and SUB MIC input.

③ **MIC PAN**

Adjusts the panning for both the MAIN and SUB MIC.

④ **TRIM (PGM1 /PGM2)**

Adjusts the input level of each channel. For optimal acoustic quality, set the INPUT FADER to a position of 7 or 8 then adjust the TRIM so that a sufficient signal is fed through the channel without distorting.

⑤ **PGM EQs (PGM1 /PGM2)**

Adjusts the HI and LOW frequencies for each PGM channel.

⑥ **PGM BALANCE (PGM1 /PGM2)**

Adjusts the stereo balance for each PGM Channel. Can also be used to adjust an unbalanced stereo image. From a center position a clockwise rotation will increase the volume of channel R over L. Whereas, a Counter clockwise rotation will increase the volume of channel L over R.

⑦ **CROSSFADER REVERSE SWITCH**

Reverses the action of the crossfader by switching PGM1 and 2. Reverse mode, when on, is indicated in the LED section.

⑧ **MASTER LEVEL VOLUME**

Adjusts the signal level outputs from LINE OUT.

⑨ **CROSSFADER CURVE**

Adjusts the crossfader curve. A clockwise rotation gives a steep crossfader good for scratching and cutting, whereas, a counter clockwise rotation gives a gentle crossfader good for long running mixes.

⑩ **POWER LED**

Lights up when the POWER SWITCH is on.

⑪ **INPUT SELECTOR**

Used to select the input (LINE or PHONO) to be sent to each PGM channel. The upper most position will select PHONO input. This selector switch can also be used to perform for TRANSFORMER SCRATCH. The operation direction of this switch is selectable. To change the operational direction of this switch remove the top panel and make the necessary the top panel.

⑫ **INPUT FADER (PGM1 /PGM2)**

Used to adjust the input level of each PGM channel. The Input fader curve can be changed using a switch located on the unit itself. This fader is a user replaceable unit. Ensure that you replace with an IF-05PCV when it is worn out. For more comprehensive instructions please refer to the "HOW TO CHANGE THE FADER UNIT" section of this user guide.

⑬ **INPUT LEVEL METER**

The LED level meters indicate the signal level of each

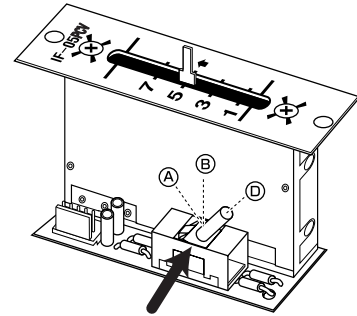

I.F. CURVE SELECT SWITCH

IF-05PCV INPUT FADER CURVE

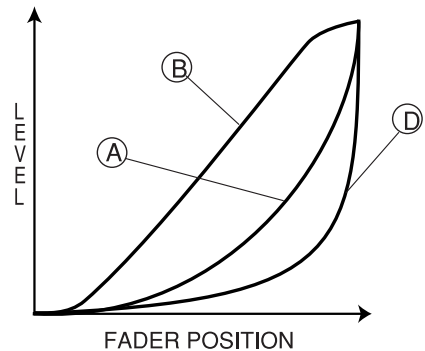

PGM channel.

⑭ **CROSSFADER**

When the input levels of PGM1 and PGM2 are properly set, PGM1 will be heard with the crossfader set to the left side. PGM2 will be heard with the cross fader set to the right side. When the crossfader is set in the center, both programs will be heard. This is user replaceable fader Replace with a "CF-PCV" when it is worn out.

⑮ **EFFECT RCV LEVEL**

Adjusts the signal level input from an external effects unit connected to the EFFECT RCV jacks on the front panel.

⑯ **EFFECT SEND LEVEL**

Adjusts the signal level output to an external effects unit connected to the EFFECT SEND JACK on the rear panel.

⑰ **EFFECT SEND ON/OFF SWITCH**

This switch is used to select the PGM to be sent to EFFECT SEND JACK.

⑱ **MONITOR LEVEL**

Adjusts the headphone monitor level.

⑲ **CF MONITOR**

Crossfaders signal to be monitored from each program.

⑳ **MONITOR SELECT SWITCH**

This switch is used to select the signal sent to the monitor section. When set to CUE the signal heard is determined by which PGM is being sent to the master and the location of the Monitor Cross Fader (19). When set to MASTER you will hear the master signal in the monitor section.

FRONT PANEL



②1 PHONE JACK

Connect the headphones with the impedance of 8ohm to 600ohm.

②2 EFFECT RECEIVE JACK

Connect to the output of the external effects.

②3 EFFECT SEND JACK

Connect to the input of the external effects. (Delay, Reverb etc)

REAR PANEL

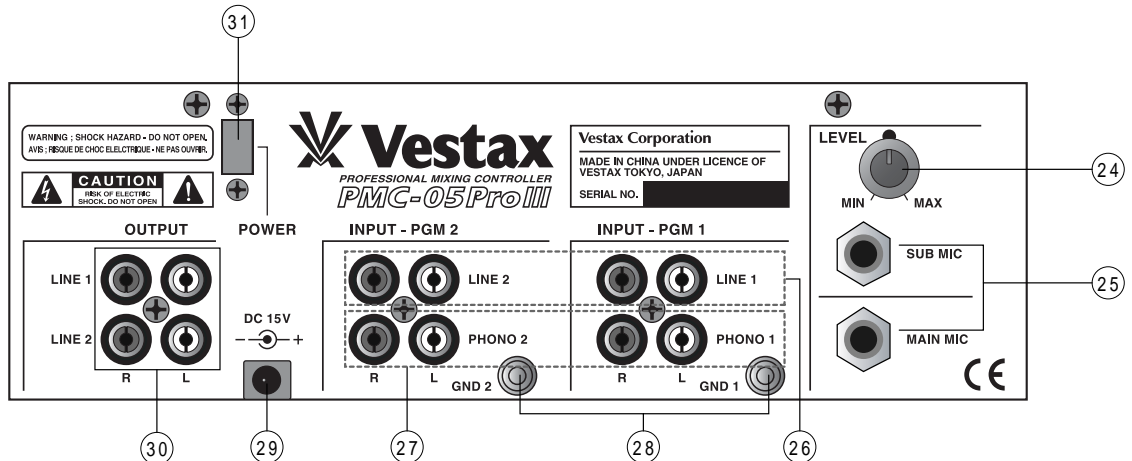

②4 SUB MIC LEVEL

Adjusts the input level from SUB MIC IN.

②5 MAIN/SUB MIC JACK

Input jack for MAIN/SUB MIC.

②6 LINE INPUT JACK

These jacks are used to connect line level output devices to the PMC-05proIII. Devices with a line level of -10dB to 0db, such as CD player, MD players, tape decks, DAT players etc. may be connected to these jacks. The signal from these devices is then fed to the respective PGM when Line Input is selected.

②7 PHONO INPUT JACK

These jacks are used to connect turntables equipped with moving magnet (MM) type cartridges. Once

connected, the signal from the turntable is fed to the respective PGM when the Phono Input is selected.

②8 GROUND TERMINAL

Connect this terminal to the ground lead of the turntables.

②9 POWER JACK

Connect the Vestax DC-15A , AC adaptor.

③0 LINE OUT

The PMC-05ProIII has two pairs of Line Out jacks sending the same output signal to an external amplification device. Connect your power amplifier or other like amplification device to these jacks.

③1 POWER SWITCH

Use to turn power on.

HOW TO CHANGE THE FADER UNIT

- ① Remove the fader knobs. (See fig-a)
- ② Remove the 4 screws which fix the top panel. (See fig-a)
- ③ Remove the 2 screws which fix the fader panel, and remove the fader unit from position in mixer. (See fig-b)
- ④ Carefully remove the multi-cable connector from the fader unit.
- ⑤ Remove the fader knob of new fader unit.
- ⑥ Attach multi-cable connector to new fader unit. (See fig-c/d)
- ⑦ Position the new fader unit carefully and secure with screws.

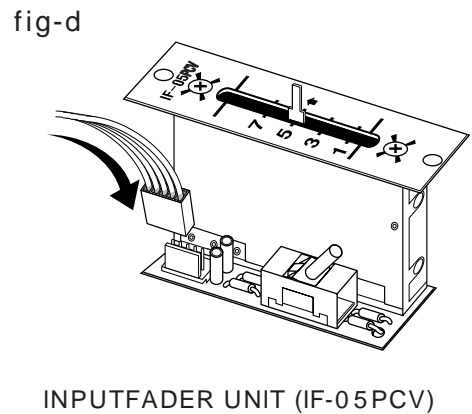
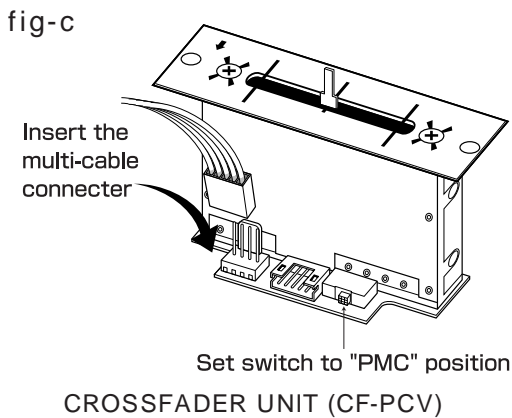
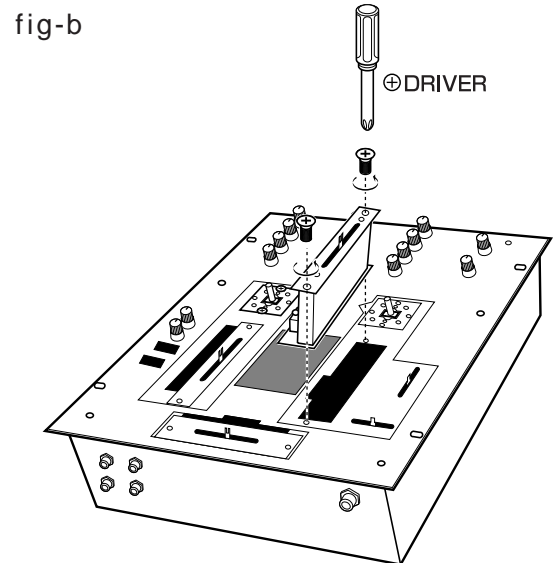
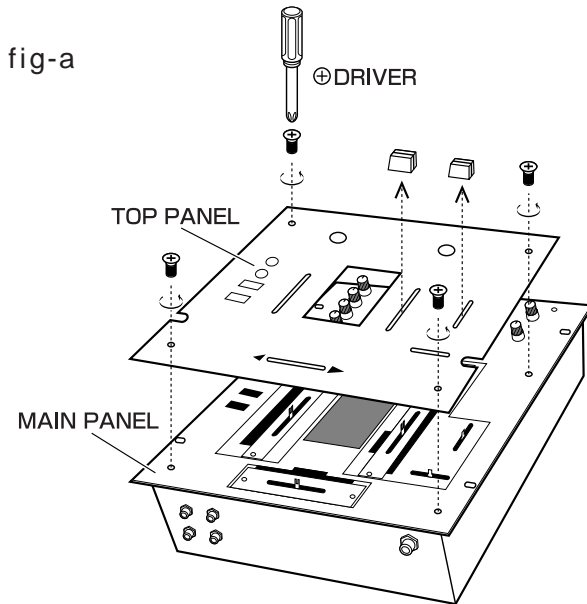

HOW TO CHANGE INPUT SELECT SWITCH

- ① Remove the top panel in the same procedure. (See fig-a)
- ② Remove the 2 screws which fix the switch panel, fix the switch panel, and remove the switch unit from position in mixer. (See fig-e)
- ③ Carefully remove the multi-cable connector from the switch unit. (See fig-f)
- ④ Attach multi-cable connector to new switch unit.
- ⑤ Position the switch unit carefully, and secure with screws.

HOW TO CHANGE THE DIRECTION INPUT SELECT SWITCH

- ① Remove the top panel in the same procedure. (See fig-a)
- ② Remove the 2 screws which fix the switch panel, and remove the switch unit from position in mixer. (See fig-e)
- ③ Change the direction, and secure with screws.
- ④ Replace the top panel and secure with screws.

fig-e

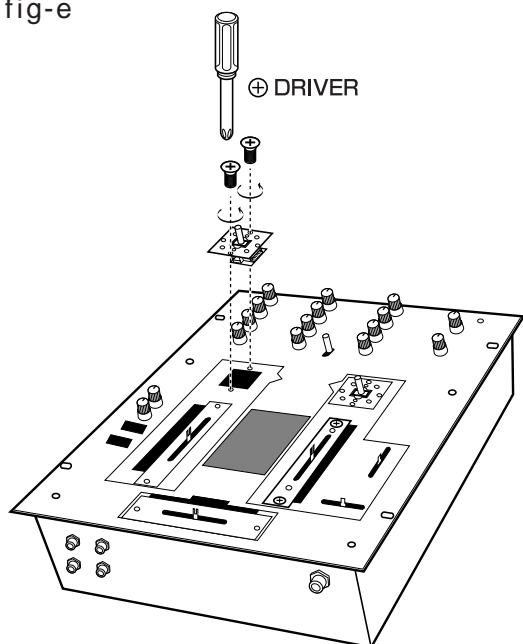
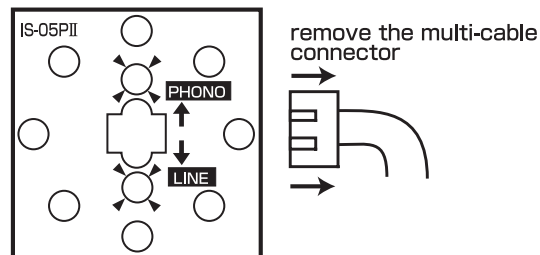

fig-f



CONNECTION

TURN TABLE [VESTAX PDX-2000]



OUT PUT
PHONO1
EARTH

TURN TABLE [VESTAX PDX-2000]



OUT PUT
PHONO2
EARTH

CD PLAYER [VESTAX CDX-16]

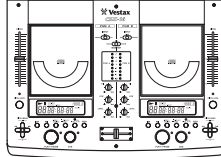

OUT PUT
LINE2
OUT PUT
LINE1

SPEAKER

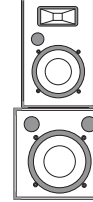

POWER AMP [VESTAX DA-X1000]

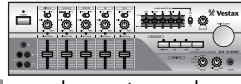

IN PUT

SPEAKER

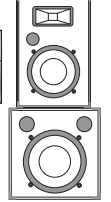

LINE OUT

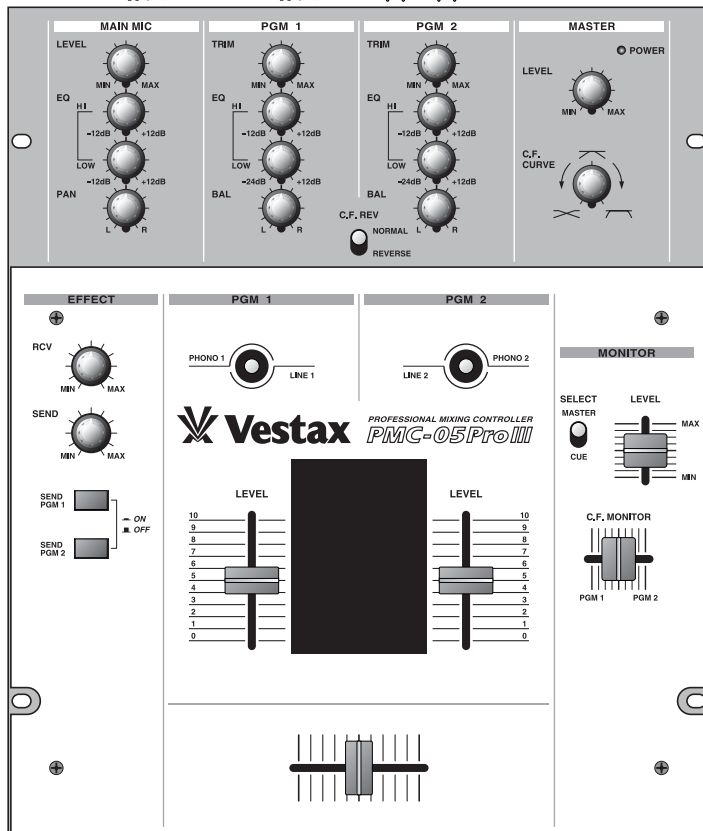

EFFECT SEND
IN
EFFECT RCV
OUT

EFFECT UNIT (DRY · REVERB)



SPECIFICATION

		NOMINAL INPUT LEVEL	IMPEDANCE
INPUT SECTION	MIC	-54dBv	3.3k
	LINE	-10dBv	10k
	PHONO	-42dBv	56
	RCV	-10dBv	10k
		NOMINAL OUTPUT LEVEL	IMPEDANCE
OUTPUT SECTION	LINE	-10dBv	2k
	PHONES	58mW MAX (@47)	8
	SEND	10dBv	2k
FREQUENCY RESPONSE		25Hz ~ 25kHz	
CROSS TALK		100dB	
SN RATIO		75dB	
THD		< 0.01%	
DIMENSION			
WEIGHT		3.5kg	



Free Manuals Download Website

<http://myh66.com>

<http://usermanuals.us>

<http://www.somanuals.com>

<http://www.4manuals.cc>

<http://www.manual-lib.com>

<http://www.404manual.com>

<http://www.luxmanual.com>

<http://aubethermostatmanual.com>

Golf course search by state

<http://golfingnear.com>

Email search by domain

<http://emailbydomain.com>

Auto manuals search

<http://auto.somanuals.com>

TV manuals search

<http://tv.somanuals.com>