

ViewSonic®

DPX704WH
DPX804WH
DPX1004WH
DPX704BK
DPX804BK
DPX1004BK
DPX704RW
DPX804RW
DPX1004RW

Digital Photo Frame

- Quick Start Guide
- Guide de démarrage rapide
- Schnellstartanleitung
- Guida rapida
- Guía de inicio rápido
- Краткое руководство



Model No. : VS12207
VS12190
VS12191

Compliance Information

FCC Statement

This device complies with part 15 of FCC Rules. Operation is subject to the following two conditions: (1) this device may not cause harmful interference, and (2) this device must accept any interference received, including interference that may cause undesired operation.

This equipment has been tested and found to comply with the limits for a Class B digital device, pursuant to part 15 of the FCC Rules. These limits are designed to provide reasonable protection against harmful interference in a residential installation. This equipment generates, uses, and can radiate radio frequency energy, and if not installed and used in accordance with the instructions, may cause harmful interference to radio communications. However, there is no guarantee that interference will not occur in a particular installation. If this equipment does cause harmful interference to radio or television reception, which can be determined by turning the equipment off and on, the user is encouraged to try to correct the interference by one or more of the following measures:

- Reorient or relocate the receiving antenna.
- Increase the separation between the equipment and receiver.
- Connect the equipment into an outlet on a circuit different from that to which the receiver is connected.
- Consult the dealer or an experienced radio/TV technician for help.

Warning: You are cautioned that changes or modifications not expressly approved by the party responsible for compliance could void your authority to operate the equipment.

For Canada

- This Class B digital apparatus complies with Canadian ICES-003.
- Cet appareil numérique de la classe B est conforme à la norme NMB- du Canada.

CE Conformity for European Countries



The device complies with the requirements of the EEC directive 2004/108/EC as amended by 92/31/EEC and 93/68/EEC Art.5 with regard to “Electromagnetic compatibility”, and 2006/95/EC as amended by 93/68/EEC Art.13 with regard to “Safety.”

Following information is only for EU-member states:

The mark shown to the right is in compliance with the Waste Electrical and Electronic Equipment Directive 2002/96/EC (WEEE).

The mark indicates the requirement NOT to dispose the equipment as unsorted municipal waste, but use the return and collection systems according to local law.



Important Safety Instructions

1. Read these instructions.
2. Keep these instructions.
3. Heed all warnings.
4. Follow all instructions.
5. Do not use this unit near water.
6. Clean with a soft, dry cloth. If still not clean, see “Cleaning the Display” in this guide for further instructions.
7. Do not block any ventilation openings. Install the unit in accordance with the manufacturer’s instructions.
8. Do not install near any heat sources such as radiators, heat registers, stoves, or other devices (including amplifiers) that produce heat.
9. Do not defeat the safety purpose of the polarized or grounding-type plug. A polarized plug has two blades with one wider than the other. A grounding type plug has two blades and a third grounding prong. The wide blade and the third prong are provided for your safety. If the provided plug does not fit into your outlet, consult an electrician for replacement of the obsolete outlet.
10. Protect the power cord from being walked on or pinched particularly at plugs. Convenience receptacles and the point where they exit from the unit. Be sure that the power outlet is located near the unit so that it is easily accessible.
11. Only use attachments/accessories specified by the manufacturer.
12.  Use only with the cart, stand, tripod, bracket, or table specified by the manufacturer, or sold with the unit. When a cart is used, use caution when moving the cart/unit combination to avoid injury from tipping over.
13. Unplug this unit when unused for long periods of time.
14. Refer all servicing to qualified service personnel. Servicing is required when the unit has been damaged in any way, such as: if the power-supply cord or plug is damaged, if liquid is spilled onto or objects fall into the unit, if the unit is exposed to rain or moisture, or if the unit does not operate normally or has been dropped.

Declaration of RoHS Compliance

This product has been designed and manufactured in compliance with Directive 2002/95/EC of the European Parliament and the Council on restriction of the use of certain hazardous substances in electrical and electronic equipment (RoHS Directive) and is deemed to comply with the maximum concentration values issued by the European Technical Adaptation Committee (TAC) as shown below:

English

Substance	Proposed Maximum Concentration	Actual Concentration
Lead (Pb)	0.1%	<0.1%
Mercury (Hg)	0.1%	<0.1%
Cadmium (Cd)	0.01%	<0.01%
Hexavalent Chromium (Cr ⁶⁺)	0.1%	<0.1%
Polybrominated biphenyls (PBB)	0.1%	<0.1%
Polybrominated diphenyl ethers (PBDE)	0.1%	<0.1%

Certain components of products as stated above are exempted under the Annex of the RoHS Directives as noted below:

Examples of exempted components are:

1. Mercury in compact fluorescent lamps not exceeding 5 mg per lamp and in other lamps not specifically mentioned in the Annex of RoHS Directive.
2. Lead in glass of cathode ray tubes, electronic components, fluorescent tubes, and electronic ceramic parts (e.g. piezoelectric devices).
3. Lead in high temperature type solders (i.e. lead-based alloys containing 85% by weight or more lead).
4. Lead as an alloying element in steel containing up to 0.35% lead by weight, aluminium containing up to 0.4% lead by weight and as a copper alloy containing up to 4% lead by weight.

Package Contents

- Digital Photo Frame
- Remote Control
- Power Adapter
- Quick Start Guide
- USB Cable (Optional)

Identifying the Parts

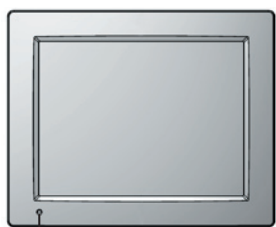

1

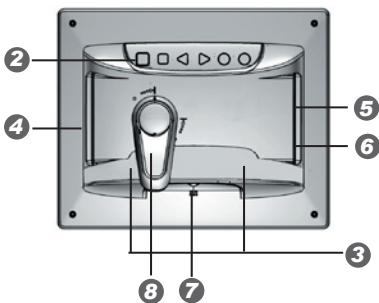

- | | |
|-----------------------|---------------------------------|
| 1 IR Sensor | 4 CF Card Slot |
| 2 Power button | 5 xD/SD/MMC/MS Card Slot |
| Mode button | 6 USB Port |
| Previous button | 7 DC-IN Jack |
| Next button | 8 Stand |
| Stop/Exit button | |
| OK/Menu button | |
| 3 Speakers | |

Remote Control

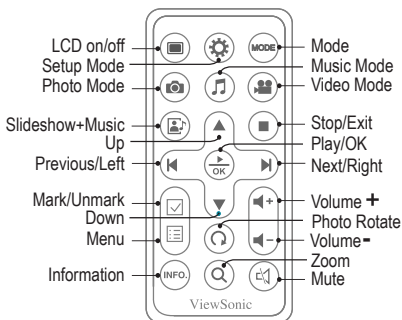
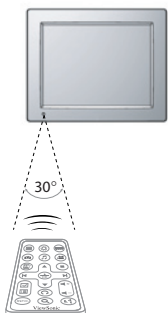

CAUTION: Danger of explosion if the remote control's battery is incorrectly replaced. Replace only with the same or equivalent type.

Download from www.Somanuals.com. All Manuals Search And Download.

Getting Prepared

Inserting Memory Cards

With the label side facing the back of the photo frame, insert the memory card containing pictures, video clips, or music files to be displayed in the direction as illustrated.

- To remove cards, gently pull it out in the opposite direction.

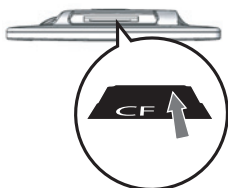
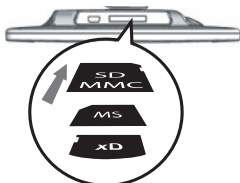

- The digital photo frame accommodates xD/CF/SD/MMC/MS cards.
- Before inserting the card, be sure it is formatted in FAT file system. Otherwise, the photo frame may not recognize the media files.
- Processing speed and file size are positively correlated in that large images take longer to load. To optimize its performance, it is suggested to use images less than 8 megapixel.

Positioning the photo frame

For desktop display, spread the stand as far as it can be spread on a flat and stable surface.



Landscape display



Portrait display

Powering it on

Connect the device to a power source with the supplied power adapter.

Press  to turn on the digital photo frame.

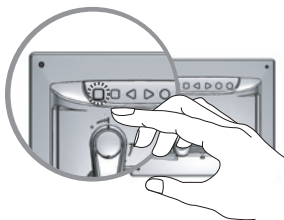
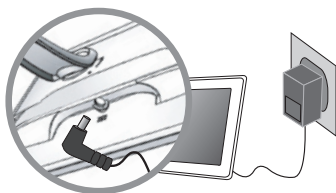

- Power Adapter Output: 12Vdc, 0.8A (DPX704WH/DPX804WH/DPX704BK/DPX804BK/DPX704RW/DPX804RW); 12Vdc, 1.25A (DPX1004WH/DPX1004BK/DPX1004RW)

Operation

Use **MODE** to bring up the function bar.

Use **⏪/⏩** to move to the desired mode; press **OK/▶** to confirm.

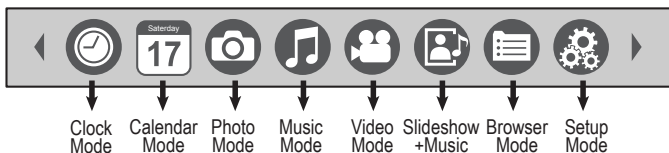

Clock Mode



Display the current time

- If the alarm is activated, the alarm time will be displayed.

Calendar Mode



Display the monthly calendar

- Use **▲▼⏪/⏩** to move to the desired month.









Photo Mode



Display all photos as a slideshow

- To enlarge the photo, press **Q**.
- To rotate the photo clockwise, press **↻**.

To apply various settings for the selected photo, press **OK/▶**. A toolbar appears. Use **⏪/⏩** to scroll through it; press **OK/▶** to confirm.

	Rotate	Rotate the photo clockwise (90°/180°/270°)
	Zoom	Enlarge the photo to show the details
	Previous	Go back to previous photo
	Next	Advance to next photo
	Play/Pause	Pause or resume the slideshow
	Stop	Stop the slideshow
	Photo Info	Display photo information
	Thumbnails	Display photos in thumbnail mode
800X600	Resolution	Display photo resolution



Music Mode

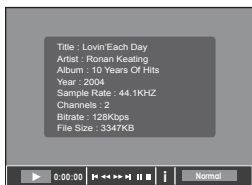

Play songs

- To adjust the volume, press + .
- To mute the music, press .

To apply various settings for the selected music, press / . A toolbar appears. Use / to scroll through it; press / to confirm.

0:00:00	Elapsed Time	Display the elapsed time
	Previous	Go back to previous music
	F. Bwd	Reverse the playback
	F. Fwd	Speed up the playback
	Next	Advance to next music
	Play/Pause	Pause or resume the playback
	Stop	Stop the playback
	Music Info	Display music information
	Normal	Play all music once
	Repeat One	Repeat the currently selected music continuously
	Repeat All	Repeat all music continuously



Video Mode



Play video files

- To adjust the volume, press + .
- To mute the music, press .

To apply various settings for the selected video file, press / . A toolbar appears. Use / to scroll through it; press / to confirm.

0:00:00	Elapsed Time	Display the elapsed time
	Previous	Go back to previous video file
	F. Bwd	Reverse the playback
	F. Fwd	Speed up the playback
	Next	Advance to next video file
	Play/Pause	Pause or resume the playback
	Stop	Stop the playback
	Zoom	Enlarge the video to show the details
	Video Info	Display video file information



Slideshow + Music Mode



Display photos one by one, together with background music

- To enlarge the photo, press
- To rotate the photo clockwise, press
- To adjust the volume, press
- To mute the music, press

To apply various settings for the selected photo, press / . A toolbar appears. Use / to scroll through it; press / to confirm.



Browser Mode

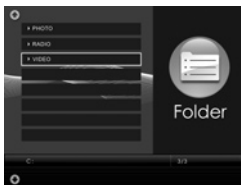

List out all of media files

Use / to scroll through files; press / to play it back.

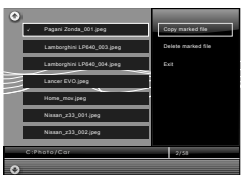

Copy / Delete files

- Use to mark files; press to open menu, and select COPY / DELETE function. (Copy the files to internal memory directly.)
- For remote control operating only.



Setup Mode

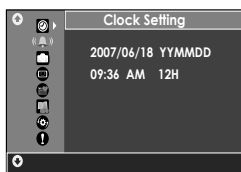

Use / to scroll through menu options; press / to confirm.



Clock Setting

yyyy/mm/dd YYMMDD/MMDDYY/DDMMYY
mm:ss AM/PM 12H/24H



Alarm Setting

yyyy/mm/dd
mm:ss
Ring 1/2
Mode Once/Daily/Off



Photo Setting

Interval Fast, Medium, Slow
Transition select one to apply the
 slideshow effect
Display Standard, Smart



Display Setting

Brightness, Contrast, Color



Startup Setting

Clock, Calendar, Photo, Music, Video, Slideshow
with music, Browser



Language Setting

English, Deutsch, Français, Italiano, Español, Nederlands,
Português, Русский, 繁體中文, 简体中文



Default Setting

Restore Default



Firmware Version

Display the current firmware version

Connecting to External Devices

Mass Storage

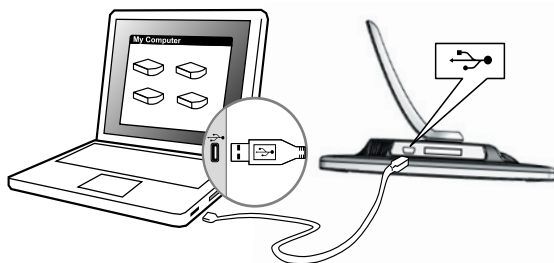

1. Power on the photo frame.
2. Connect the photo frame to computer's USB port with USB cable.
3. The photo frame now functions as a card reader.

- Your photo frame comes with 128MB of built-in memory.
- When connected to a computer running Windows® 2000 or XP, the photo frame will be recognized instantly; no software installation is required.

Customer Support

For technical support or product service, see the table below or contact your reseller.

Note : You will need the product serial number.

Country/Region	Web Site	T=Telephone F=Fax	E-mail
Australia/New Zealand	www.viewsonic.com.au	AUS=1800 880 818 NZ=0800 008 822	service@au.viewsonic.com
Canada	www.viewsonic.com	T(Toll-Free)= 1-866-463-4775 T(Toll)= 1-424-233-2533 F= 1-909-468-1202	service.ca@viewsonic.com
Europe/Middle East/Baltic countries/North Africa	www.viewsoniceurope.com	Contact your reseller	
Hong Kong	www.hk.viewsonic.com	T= 852 3102 2900	service@hk.viewsonic.com
India	www.in.viewsonic.com	T= 1800 11 9999	service@in.viewsonic.com
Korea	www.kr.viewsonic.com	T= 080 333 2131	service@kr.viewsonic.com
Latin America (Argentina)	www.viewsonic.com/la/	T= 0800 666 0194	soporte@viewsonic.com
Latin America (Brazil)	www.viewsonic.com/la/	T= 0800 891 6984	soporte@viewsonic.com
Latin America (Chile)	www.viewsonic.com/la/	T= 800 440 303	soporte@viewsonic.com
Latin America (Columbia)	www.viewsonic.com/la/	T= 01 800 915 6588	soporte@viewsonic.com
Latin America (Mexico)	www.viewsonic.com/la/	T= 001 800 514 6518	soporte@viewsonic.com
Renta y Datos, 29 SUR 721, COL. LA PAZ, 72160 PUEBLA, PUE. Tel: 01.222.891.55.77 CON 10 LINEAS Electroser, Av Reforma No. 403Gx39 y 41, 97000 Merida, Yucatan. Tel: 01.999.925.19.16 Other places please refer to http://www.viewsonic.com/la/soporte/index.htm#Mexico			
Latin America (Peru)	www.viewsonic.com/la/	T= 0800 53458	soporte@viewsonic.com
Macau	www.hk.viewsonic.com	T= 853 700 303	service@hk.viewsonic.com
Puerto Rico & Virgin Islands	www.viewsonic.com	T= 1-800-688-6688 (English) T= 1-866-379-1304 (Spanish) F= 1-909-468-1202	service.us@viewsonic.com soporte@viewsonic.com
Singapore/Malaysia/Thailand	www.ap.viewsonic.com	T= 65 6461 6044	service@sg.viewsonic.com
South Africa	www.viewsoniceurope.com	www.viewsoniceurope.com/uk/Support/Calldesk.htm	
United Kingdom	www.viewsoniceurope.com/uk/	www.viewsoniceurope.com/uk/Support/Calldesk.htm	
United States	www.viewsonic.com	T(Toll-Free)= 1-800-688-6688 T(Toll)=1-424-233-2530 F= 1-909-468-1202	service.us@viewsonic.com



ViewSonic®

82-271-00033

Free Manuals Download Website

<http://myh66.com>

<http://usermanuals.us>

<http://www.somanuals.com>

<http://www.4manuals.cc>

<http://www.manual-lib.com>

<http://www.404manual.com>

<http://www.luxmanual.com>

<http://aubethermostatmanual.com>

Golf course search by state

<http://golfingnear.com>

Email search by domain

<http://emailbydomain.com>

Auto manuals search

<http://auto.somanuals.com>

TV manuals search

<http://tv.somanuals.com>