

ViewSonic®

VT2430

LCD TV

- User Guide
- Guide de l'utilisateur
- Guía del usuario

IMPORTANT: Please read this User Guide to obtain important information on installing and using your product in a safe manner, as well as registering your product for future service. Warranty information contained in this User Guide will describe your limited coverage from ViewSonic Corporation, which is also found on our web site at <http://www.viewsonic.com> in English, or in specific languages using the Regional selection box in the upper right corner of our website.
"Before operating the equipment, read the instructions in this manual carefully."



ViewSonic®

Model No. : VS12335-1M

Dear ViewSonic customer,

Congratulations on your purchase of a ViewSonic TV display. For maximum benefit of your TV, please read these instructions before any operations.

For assistance, please contact ViewSonic service team at <http://www.viewsonic.com> or call our service team: United States 1-800-688-6688, Canada 1-866-463-4775.

To purchase or inquire about any accessories and installation services for your TV, please visit www.viewsonic.com or call: United States 1-800-688-6688, Canada 1-866-463-4775.

Important! Please save the original box and all packing material for future shipping needs.

We recommend you registering your TV on the internet at: www.viewsonic.com

Product Registration

To meet your future needs, and to receive any additional product information as it becomes available, please register your product on the Internet at: www.viewsonic.com.

For Your Records	
Product Name:	[] VT2430 ViewSonic LCD TV
Model Number:	[] VS12335-1M
Document Number:	VT2430-1M_UG_ENG Rev. 1A 09-16-08
Serial Number:	_____
Purchase Date:	_____

Product disposal at end of product life

ViewSonic is concerned about the preservation of our environment. Please dispose of this product properly at the end of its useful life. Your local waste disposal company may provide information about proper disposal.

The lamp in this product contains mercury. Please dispose of properly in accordance with environmental laws of your location.

Customer Support

For technical support or product service, see the table below or contact your reseller.

Note: You will need the product serial number.

Country/Region	Web Site	T= Telephone F= Fax	Email
United States	www.viewsonic.com	T (Toll-Free) = 1-800-688-6688 T (Toll) = 1-424-233-2530 F = 1-909-468-1202	service.us@viewsonic.com
Canada	www.viewsonic.com	T (Toll-Free) = 1-866-463-4775 T (Toll) = 1-424-233-2533 F = 1-909-468-1202	service.ca@viewsonic.com

Renta y Datos, 29 SUR 721, COL. LA PAZ, 72160 PUEBLA, PUE. Tel: 01.222.891.55.77 CON 10 LINEAS
 Electroser, Av Reforma No. 403Gx39 y 41, 97000 Mérida, Yucatán. Tel: 01.999.925.19.16
 Other places please refer to <http://www.viewsonic.com/la/soporte/index.htm#Mexico>

Contact ViewSonic service team at: <http://www.ViewSonic.com> or call our service team: United States 1-800-688-6688, Canada 1-866-463-4775

Contact Information for Sales & Authorized Service (Centro Autorizado de Servicio) within Mexico:	
Name, address, of manufacturer and importers: México, Av. de la Palma #8 Piso 2 Despacho 203, Corporativo Interpalmas, Col. San Fernando Huixquilucan, Estado de México Tel: (55) 3605-1099 http://www.viewsonic.com/la/soporte/index.htm	
NÚMERO GRATIS DE ASISTENCIA TÉCNICA PARA TODO MÉXICO: 001.866.823.2004	
Hermosillo: Distribuciones y Servicios Computacionales SA de CV. Calle Juarez 284 local 2 Col. Bugambilias C.P: 83140 Tel: 01-66-22-14-9005 E-Mail: disc2@hmo.megared.net.mx	Villahermosa: Compumantenimientos Garantizados, S.A. de C.V. AV. GREGORIO MENDEZ #1504 COL, FLORIDA C.P. 86040 Tel: 01 (993) 3 52 00 47 / 3522074 / 3 52 20 09 E-Mail: compumantenimientos@prodigy.net.mx
Puebla, Pue. (Matriz): RENTA Y DATOS, S.A. DE C.V. Domicilio: 29 SUR 721 COL. LA PAZ 72160 PUEBLA, PUE. Tel: 01(52).222.891.55.77 CON 10 LINEAS E-Mail: datos@puebla.megared.net.mx	Veracruz, Ver.: CONEXION Y DESARROLLO, S.A DE C.V. Av. Americas # 419 ENTRE PINZÓN Y ALVARADO Fracc. Reforma C.P. 91919 Tel: 01-22-91-00-31-67 E-Mail: gacosta@qplus.com.mx
Chihuahua Soluciones Globales en Computación C. Magisterio # 3321 Col. Magisterial Chihuahua, Chih. Tel: 4136954 E-Mail: Cefeo@soluglobales.com	Cuernavaca Compusupport de Cuernavaca SA de CV Francisco Leyva # 178 Col. Miguel Hidalgo C.P. 62040, Cuernavaca Morelos Tel: 01 777 3180579 / 01 777 3124014 E-Mail: aquevedo@compusupportcva.com
Distrito Federal: QPLUS, S.A. de C.V. Av. Coyoacán 931 Col. Del Valle 03100, México, D.F. Tel: 01(52)55-50-00-27-35 E-Mail : gacosta@qplus.com.mx	Guadalajara, Jal.: SERVICRECE, S.A. de C.V. Av. Niños Héroes # 2281 Col. Arcos Sur, Sector Juárez 44170, Guadalajara, Jalisco Tel: 01(52)33-36-15-15-43 E-Mail: mmiranda@servicrece.com
Guerrero Acapulco GS Computación (Grupo Sesicomp) Progreso #6-A, Colo Centro 39300 Acapulco, Guerrero Tel: 744-48-32627	Monterrey: Global Product Services Mar Caribe # 1987, Esquina con Golfo Pérsico Fracc. Bernardo Reyes, CP 64280 Monterrey N.L. México Tel: 8129-5103 E-Mail: aydeem@gps1.com.mx
MERIDA: ELECTROSER Av Reforma No. 403Gx39 y 41 Mérida, Yucatán, México CP97000 Tel: (52) 999-925-1916 E-Mail: rrrb@sureste.com	Oaxaca, Oax.: CENTRO DE DISTRIBUCION Y SERVICIO, S.A. de C.V. Murguía # 708 P.A., Col. Centro, 68000, Oaxaca Tel: 01(52)95-15-15-22-22 Fax: 01(52)95-15-13-67-00 E-Mail: gpotai2001@hotmail.com
Tijuana: STD Av Ferrocarril Sonora #3780 L-C Col 20 de Noviembre Tijuana, Mexico	FOR USA SUPPORT: ViewSonic Corporation 381 Brea Canyon Road, Walnut, CA. 91789 USA Tel: 800-688-6688 (English); 866-323-8056 (Spanish); Fax: 1-800-685-7276 E-Mail: http://www.viewsonic.com

4.3: ViewSonic Mexico Limited Warranty

LTV_LW02 Rev. 1A 06-25-07

Contact ViewSonic service team at: <http://www.ViewSonic.com> or call our service team: United States 1-800-688-6688, Canada 1-866-463-4775

Caution

Please use the following ViewSonic TVs only with the following wall-mount kit.

	ViewSonic TV Model No.
	VT2430
ViewSonic Wall-Mount kit model	WMK-10

Use with other Wall-Mount kit may cause instability and possibly result in injury.

To find the perfect mount for VT2430, please browse www.viewsonic.com or call our service team: United States 1-800-688-6688, Canada 1-866-463-4775.

Contents

Copyright Information.....	1
Warning and Notification.....	2
Important Safety Instructions	3
Compliance Information	8
Declaration of RoHS Compliance	9

Getting Started

List of Features.....	10
Package Contents	10
Installing the LCD TV	11
Installing the Stand	11
Disconnecting the Stand	11
Mounting ViewSonic LCD TV to the wall	12
Wall Mount Kit Specifications (VESA).....	13
Front View of the Product.....	14
Rear View of the Product.....	15
Connecting the LCD TV	17
Cable System or VHF/UHF Antenna System	17
Cable System and VHF/UHF Antenna System.....	17
HD Cable Box/HD Satellite Box.....	17
Personal Computer.....	19
Other Equipment.....	20

Using the TV Features

Remote Control and TV Controls.....	21
Inserting Remote Control Batteries.....	21
Remote Control and TV Controls.....	21
Operation	24

Other Information

Cleaning the LCD TV.....	36
Programming your Cable or Satellite Box remote	36
Troubleshooting	37
Specifications	39
Limited Warranty	40
Mexico Limited Warranty.....	41

Contact ViewSonic service team at: <http://www.ViewSonic.com> or call our service team: United States 1-800-688-6688, Canada 1-866-463-4775

Copyright Information

Copyright © ViewSonic® Corporation, 2008. All rights reserved.

ViewSonic, the three birds logo, OnView, ViewMatch, and ViewMeter are registered trademarks of ViewSonic Corporation.

ENERGY STAR® is a registered trademark of the U.S. Environmental Protection Agency (EPA). As an ENERGY STAR® partner, ViewSonic Corporation has determined that this product meets the ENERGY STAR® guidelines for energy efficiency.

Disclaimer: ViewSonic Corporation shall not be liable for technical or editorial errors or omissions contained herein; nor for incidental or consequential damages resulting from furnishing this material, or the performance or use of this product.

In the interest of continuing product improvement, ViewSonic Corporation reserves the right to change product specifications without notice. Information in this document may change without notice.

No part of this document may be copied, reproduced, or transmitted by any means, for any purpose without prior written permission from ViewSonic Corporation.

WARNING

Do not expose this TV to rain or moisture. It may increase the risk to fire or electronic shock.

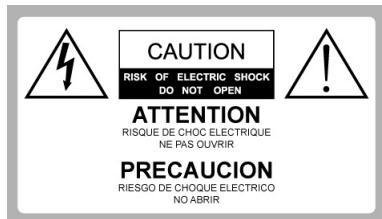

Dangerous Voltage: The lightning flash with arrowhead symbol, within an equilateral triangle, is intended to alert the user to the presence dangerous voltage within the inside of the product that may be sufficient level to constitute a risk of electric shock to persons.



Instruction: The exclamation point within an equilateral triangle is intended to alert the user to the presence of important operating and servicing instructions in the literature accompanying the appliance.

The TV shall not be exposed to dripping or splashing. Do not put objects filled with liquids, such as vases, on the TV.

CAUTION

To prevent electric shock, do not use this polarized AC plug with an extension cord, receptacle or other outlet unless the blades can be fully inserted to prevent blade exposure.

Declaration of Conformity

Trade Name: ViewSonic
Model: VT2430
Responsible Party: ViewSonic Corporation
Address: 381 Brea Canyon Road, Walnut, CA. 91789 USA
Telephone Number: 1-800-688-6688

This device complies with part 15 of the FCC rules. Operation is subject to the following two conditions: 1) This device may not cause harmful interference, and 2) this device must accept any interference received, including interference that may cause undesired operation.

NOTIFICATION

This device has been tested and found to comply with the limits for a Class B digital device, pursuant to Part 15 of the FCC Rules. These limits are designed to provide reasonable protection against harmful interference in a residential installation. This device generates, uses and can radiate radio frequency energy and, if not installed and used in accordance with the instructions, may cause harmful interference to radio communications.

However, there is no guarantee that interference will not occur in a particular installation. If this equipment does cause harmful interference to radio or television reception, which can be determined by turning the equipment off and on, the user is encouraged to try to correct the interference by one or more of the following measures:

- ◇ Reorient or relocate the receiving antenna.
- ◇ Increase the separation between the device and receiver.
- ◇ Connect the device into an outlet on a circuit different from that to which the receiver is connected.
- ◇ Consult the dealer or an experienced radio/TV technician for help.

Pursuant to FCC regulations, be cautioned that any changes or modifications not expressly approved in this manual could void your authority to operate this equipment.

Safety

- ◇ Operate the TV only on 120 – 240 V AC.
- ◇ Use the AC power cord specified by ViewSonic and suitable for the voltage where you use it.
- ◇ The plug is designed, for safety purposes, to fit into the wall outlet only one way. If you are unable to insert the plug fully into the outlet, contact your dealer.
- ◇ If any liquid or solid object should fall inside the cabinet, stop operating, unplug the TV immediately and have it check by qualified service technician.

- ◇ If you will not be using the TV for a long time, disconnect the power by pulling the plug itself. Do not pull on the cord.
- ◇ For details concerning safety precautions, refer to “Important Safety instructions” on page 3.

Installation

- ◇ The TV should be installed near an easily accessible power outlet.
- ◇ To prevent internal heat buildup, do not block the ventilation openings.
- ◇ Do not install the TV in a hot or humid place, or in a place subject to excessive dust or mechanical vibration.
- ◇ Avoid operating the TV at temperatures below 41°F (5°C).
- ◇ When the TV is transported directly from a cold to a warm location, or if the room temperature changes suddenly, the picture may be blurred or show poor color due to moisture condensation. In this case, please wait a few hours before turning on the TV, in order to let the moisture evaporate first.
- ◇ To ensure best picture quality, do not expose the screen to direct illumination or sunlight. We recommend you use spot lighting directed down from the ceiling or to cover the windows that face the screen with opaque curtains. It is better that TV is installed where the floor and walls are not of a reflective material.

To Customers

To install the specified TV, sufficient expertise is required. Make sure you subcontract the installation to ViewSonic dealer or licensed contractors and pay adequate attention to safety during the installation.

Note

This television includes a QAM demodulator, which should allow you to receive unscrambled digital cable television programming via subscription service to a cable service provider. The type of programming and signal provided by your cable service provider will affect the availability of digital cable television programming in your area.

Trademark Information



Macintosh is a trademark of Apple Inc., registered in the U.S. and other countries. HDMI, the HDMI logo and High-Definition Multimedia Interface are trademarks or registered trademarks of Dolby Laboratories.

Blu-ray Disc is a trademark.

Adobe is a registered trademark or a trademark of Adobe Systems Incorporated in United States and/or other countries.

Contact ViewSonic service team at: <http://www.ViewSonic.com> or call our service team: United States 1-800-688-6688, Canada 1-866-463-4775

Important Safety Instructions

- 1) Read these instructions completely before using the equipment.
- 2) Keep these instructions in a safe place.
- 3) Heed all warnings.
- 4) Follow all instructions.
- 5) Do not use this apparatus near water.
- 6) Clean with a soft, dry cloth.
- 7) Do not block any ventilation openings. Install the equipment in accordance with the manufacturer's instructions.
- 8) Do not install near any heat sources such as radiators, heat registers, stoves, or other devices (including amplifiers) that produce heat. 
- 9) Do not attempt to circumvent the safety provisions of the polarized or grounding-type plug. A polarized plug has two blades with one wider than the other. A grounding type plug has two blades and a third grounding prong. The wide blade and the third prong are provided for your safety. If the provided plug does not fit into your outlet, consult an electrician for replacement of the outlet.
- 10) Prevent the power cord from being tread upon or pinched, particularly at the plug, convenience receptacles, and the point where they exit from the device. Be sure that the power outlet is located near the equipment so that it is easily accessible.
- 11) Only use attachments/ accessories specified by the manufacturer.
- 12) Use only with the cart, stand, tripod, bracket, or table specified by the manufacturer, or sold with the apparatus. When a cart is used, use caution when moving the cart/apparatus combination to avoid injury from tip-over. 
- 13) Unplug this apparatus when it will be unused for a long period of time.
- 14) Refer all servicing to qualified service personnel. Servicing is required when the apparatus has been damaged in any way, such as power-supply cord or plug is damaged, liquid has been spilled or objects have fallen into the apparatus, the apparatus has been exposed to rain or moisture, or the unit does not operate normally, or has been dropped.

USE

AC power Cord

Keep the following guidelines to protect the AC power cord from being damaged. If the AV power cord is damaged, it may result in a fire or an electric shock. Stop using it and ask your dealer or ViewSonic service center to exchange it.

- ◇ Do not place the TV where the power cord is subject to wear or abuse.
- ◇ Do not pinch, bend, or twist the cord excessively. The core lines may be bared and cut, causing a short-circuit, and resulting in a fire or an electric shock.
- ◇ Do not convert or damage the power cord.
- ◇ Avoid power cord being rolled over or rested upon. 
- ◇ When the power cord plugged in, do not move the TV.
- ◇ Keep the power cord away from heat sources.
- ◇ When you disconnect the AC power cord, disconnect it from the wall outlet first.
- ◇ When disconnecting the power cord, grasp the plug instead of pulling the power cord.
- ◇ Use only an original ViewSonic AC power cord, not other brands.
- ◇ Do not use the supplied AC power cord on any other equipment.

Wall outlet

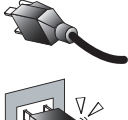
The TV set with a three-wire grounding type AC power cord plug must be connected to an AC power socket outlet with a protective grounding connection. 

Do not use an unfitting outlet.

Insert the plug fully into the outlet. If it is loose, do not use it. Doing so may cause arcing and result in a fire.

Contact your electrician to change the outlet.

Wiring

For your safety, be sure to unplug the AC power cord when connecting cables.

Take care not to trip on the cables. It may cause damage to the TV set.

Electric shock

Do not touch the AC power cord or the TV with a wet hand. If you plug/unplug the AC power cord from the TV with a wet hand, it may cause electric shock. 

Lightning storms

During a lightning storm, unplug the TV from the wall outlet and disconnect the antenna to prevent damage to the TV.

Contact ViewSonic service team at: <http://www.ViewSonic.com> or call our service team: United States 1-800-688-6688, Canada 1-866-463-4775

When not in use

If you will not be using the TV set for long periods of time, the TV set should be disconnected from the AC power outlet to prevent power line surges. The TV set is not disconnected from the AC power source when the TV set is switched off. To disconnect the TV set completely, unplug from the AC power outlet.

Overloading

This TV set is designed to operate on a 120 - 240 V AC supply only. If there are too many appliances connected to the same AC power outlet, it could result in a fire or an electric shock.

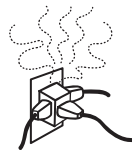

Optional equipment

If optional equipment is to be installed, leave some space between optional equipment and the TV set. Picture distortion and/or noisy sound may occur if the TV set is positioned in close proximity to any equipment emitting electromagnetic radiation.

Small accessories

Keep small accessories in as safe place where children are unable to reach.

ANTENNAS

Outdoor antenna grounding

If an outdoor antenna is installed, follow the precautions below. Do not install the outdoor antenna system in near of overhead power lines or other electric light or power circuits, or where it can come in contact with such power lines or circuits.

WHEN INSTALLING AN OUTDOOR ANTENNA SYSTEM, EXTREME CARE SHOULD BE TAKEN TO KEEP FROM CONTACTING SUCH POWER LINES OR CIRCUITS AS CONTACT WITH THEM IS ALMOST INVARIABLY FATAL.

Be sure the antenna system is grounded so that it can provide some protection against voltage surges and built-up static charges.

Section 810 of the National Electrical Code (NEC) in the U.S.A. and Section 54 of the Canadian Electrical Code in Canada provides information with in regard to proper grounding of the mast and supporting structure, grounding of the lead-in wire to an antenna discharge unit, size of grounding conductors, location of antenna discharge unit, connection to grounding electrodes, and requirements for the grounding electrode.

Antenna grounding according to the National Electrical Code, ANS/NFPA 70

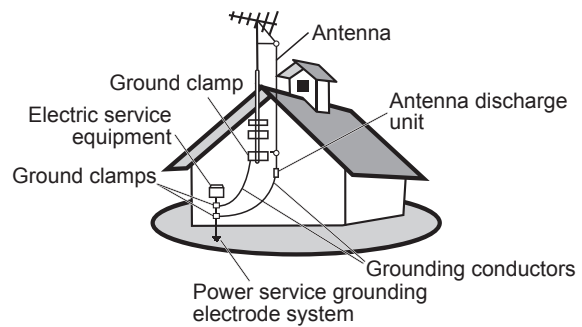

NEC: National Electrical Code

BATTERIES

- ◇ Do not cast away batteries in a fire.
- ◇ Do not disassembled, overheat, or short-circuit the batteries.
- ◇ If battery replaced in the wrong way, it may cause danger of explosion. Replace only with the same or equivalent type.

Dispose used batteries

To preserve our environment, dispose of used batteries according to your local laws or regulations.

CLEANING

Cleaning the AC power plug

Unplug the AC power plug and clean it regularly. If the plug is covered with dust and gathers moisture, its insulation may deteriorate and result in a fire.

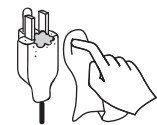

Cleaning the screen surface/ cabinet of the TV set

When cleaning this TV, unplug the AC power cord. If not, it may result in electric shock. Use a dry soft cloth to clean the cabinet of the TV. To remove dust form the screen, wipe it gently with a soft cloth. Stubborn stains may be removed with a cloth slightly dampened with a solution of mild soap and warm water. Never use strong solvents such as thinner or benzine for cleaning. If using a chemically pretreated cloth, please follow the instruction provided on the package. The ventilation holes can accumulate dust over time. To ensure proper ventilation, we recommend you to remove the dust periodically (once a month) using a vacuum cleaner, while the LCD TV is powered off.



Contact ViewSonic service team at: <http://www.ViewSonic.com> or call our service team: United States 1-800-688-6688, Canada 1-866-463-4775

MAGNETIC INFLUENCE

This TV contains a strong magnet in the speaker unit that generates a magnetic field. Keep any items susceptible to magnetic fields away from the speaker.

SOUND

If you hear snapping or popping sound comes from the TV continuously or frequently while the TV is operating, unplug the TV and consult your dealer or service technician. It is normal for some TVs to make occasional snapping or popping sounds, particularly when being turned on or off.



CARRYING THE TV

Carry the TV as instructed

To prevent dropping the TV and causing serious injury, you must follow these guidelines:

- ◇ Disconnect all cables before carrying the TV.
- ◇ Carrying the large size TV requires at least two or three people.
- ◇ When you carry the TV, place your hands as illustrated and hold it securely. Do not put stress on the LCD panel and the frame around the screen.
- ◇ When carrying the TV, do not subject it to shocks, vibration, or excessive force.
- ◇ When lifting or moving the TV, hold it securely from the bottom. Place your palm directly under the panel.

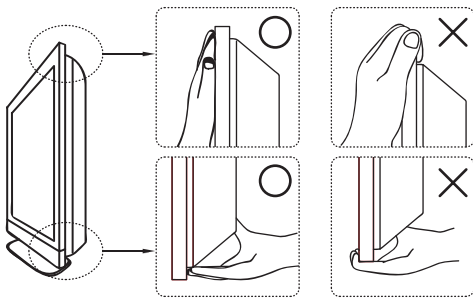

VENTILATION

Slots and openings in TV are provided for ventilation. To ensure reliable operation of the TV and to protect it from overheating, be sure these openings are not blocked or covered.

The TV may accumulate dust and get dirty if proper ventilation is not provided. For proper ventilation, follow the following guidelines:

- ◇ Never install the TV face up, down or sideways.
- ◇ Never install the TV turned over or upside down.
- ◇ Never cover the slots and openings with a cloth or other materials.
- ◇ Never block the slots and openings by placing the TV on a bed, sofa, rug or other similar surface.
- ◇ Never place the TV in a confined space, such as a bookcase or built-in cabinet, unless proper ventilation is provided.

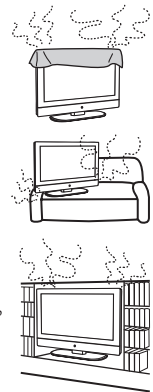

Leave some space around the TV set as shown below. Otherwise, air-circulation may be inadequate and cause overheating, which may cause a fire or damage to the TV set.

Installed on the wall

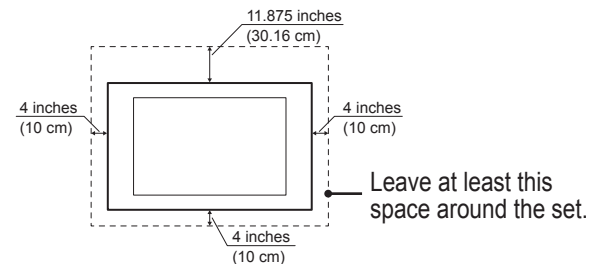

Installed with stand

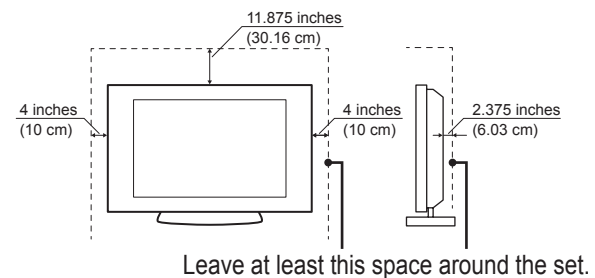

Do not install the TV set as follows:

Air circulation is blocked.

Air circulation is blocked.

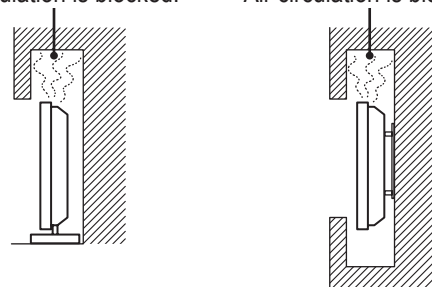

Contact ViewSonic service team at: <http://www.ViewSonic.com> or call our service team: United States 1-800-688-6688, Canada 1-866-463-4775

Objects and ventilation holes

Never push any objects into the slots on the TV cabinet as they may touch dangerous voltage points or short out parts that could result in a fire or an electric shock. Do not place any objects on the TV.

MOISTURE

Moisture and flammable objects

- ◇ Keep the product away from moisture. Do not expose this appliance to rain or moisture. Do not place objects filled with liquids, such as vases, on the TV.
- ◇ Do not use power-line operated V sets near water, such as in places like a bathtub, washbowl, kitchen sink, laundry tub, a wet basement, or near a swimming pool, etc. It may cause fire or electric shock.
- ◇ Do not let this TV get wet. Never spill liquid of any kind on the TV. If water penetrates into the product, unplug the power cord and contact ViewSonic. Do not operate the TV. It may result in electric shock or damage to the TV.
- ◇ To prevent fire, keep flammable objects or open flame (e.g. candles) away from the TV.



Do not install the TV in places subject to extreme temperature, such as in direct sunlight, near a radiator, or heating vent. If the TV is exposed to extreme temperature, the TV may overheat and cause deformation of the enclosure or cause malfunction. Do not install the TV in a place exposed to direct air conditioning. If the TV is installed in such a location, moisture may condense inside and may cause a malfunction.

- ◇ Do not place the TV in hot, oily, humid or excessively dusty places.
- ◇ Do not install the TV where insects may enter.
- ◇ Do not install the TV where it may be exposed to mechanical vibration.
- ◇ Do not install the TV in a location where it may spear up, such as on or behind a pillar, or where you might bump your head on it. It may cause injury.



Preventing the TV from toppling over

To prevent the TV from toppling over, secure the TV to a wall or stand.

Placement for watching

We suggest you to watch the TV at a distance of 3-7 times that of the screen height, and not in excessive brightness. It is easy to cause eye fatigue if you watch TV for too long or in a dark room. To obtain clear picture, do not expose the screen to direct illumination or sunlight. Use spot lighting directed down from the ceiling if you can.

INSTALLATION

To do Wall mount installation, you need a Wall-Mount Bracket. When installing or removing the TV using the Wall-Mount Bracket, be sure to use qualified contractors. If not properly secured during installation or removal from the Wall-Mount Bracket, the TV may fall and cause serious injury.

Optional wall mount

- ◇ When installing the TV using a Wall-Mount Bracket, make sure you follow the operating instructions supplied with the Wall-Mount Bracket.
- ◇ Attach the brackets supplied with the Wall-Mount Bracket.
- ◇ The TV is not designed for hanging from the ceiling. It may fall and cause serious injury.

Placement

The TV should be installed near an easily accessible AC power outlet.

Observe the following to prevent the TV from falling from the stand or wall mount.

- ◇ Place the TV on a stable, level surface.
- ◇ Do not hang anything on the TV. Do not allow children to climb on the TV.



Use in outdoor

This TV is not designed for outdoors installation. Do not expose the TV to rain, as it may result in a fire or an electric shock. Also, do not expose the TV to direct sunlight, as it may heat up and become damaged.

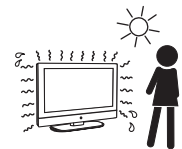

Vehicle, ships and other vessels

Do not install this TV in a vehicle.

Car accidents may cause the TV to fall down and cause injury.

Do not install this TV in a ship or vessel.

If the TV is exposed to seawater, it may cause a fire or damage the TV.

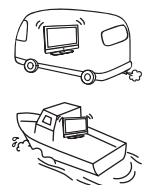

Medical institutions

Do not place this TV in a place where medical equipment is in use.

It may cause the medical equipment to malfunction.

VOLUME ADJUSTMENT

- ◇ Adjust the volume to avoid disturbing your neighbors. Sound carries easily at night. Therefore, we suggest you close the windows or use headphones.
- ◇ When using headphones, adjust the volume to appropriate levels, or hearing damage may result.

LCD SCREEN

- ◇ Although the LCD screen is made with high-precision technology and has effective pixels of 99.99% or more, black dots or bright points or light (red, blue, or green) may appear constantly on the LCD screen. This is a structural property of the LCD panel and is not a malfunction.
- ◇ The LCD screen is made with high-precision technology. To achieve a high level of performance and picture quality, this TV's backlight setting is set to maximize the brightness of the TV. However, uneven brightness may be observed when the LCD TV is viewed in a dark environment without an input source or a blank screen. This is a normal condition, not a malfunction of the TV. To improve this condition, change the Picture mode, Backlight setting, enable the Light Sensor, or turn on the Power management.
- ◇ Avoid exposing the LCD screen surface to direct sunlight. It is likely to damage the LCD panel.
- ◇ Do not push or scratch the LCD screen, or place objects on top of the TV. The image may be uneven or the LCD panel may be damaged.
- ◇ If the TV is used in a cold place, a smear may occur in the picture or the picture may become dark. This does not indicate a failure. These phenomena improve as the temperature rises.
- ◇ When still pictures are displayed continuously, ghosting may occur. It should disappear after a short period of time.
- ◇ The screen and cabinet get warm when the TV is in use. This is a normal condition.
- ◇ Spraying insect repellent with volatile material on the screen will cause damage.
- ◇ Do not make prolonged contact with rubber or plastic material.

Broken pieces

Do not throw anything at the TV. Doing so may break the screen glass and cause serious injury. If the surface of the TV cracks, unplug the AC power cord before touching the TV. Otherwise electric shock may result.



Handling of broken glass and liquid crystal leakage

If the LCD panel gets damaged, crystalline liquid leakage may occur, or scattered broken glass may result. Do not touch broken glass or crystalline liquid which is toxic, with bare hands as cuts, poisoning or skin irritation may occur. Also do not glass fragments or leaked crystalline liquid get into your eyes or mouth. Should either contacted your eyes or mouth, rinse the contacted area thoroughly with water and consult your doctor.

SERVICING

Do not attempt to repair the TV yourself, since opening the cabinet may expose you to dangerous voltage or other hazards. Ask qualified service personnel to do the servicing for your TV.



Replacement parts

When replacement parts are required, be sure the service technician certifies in writing that he/she has used replacement parts specified by the manufacturer that have the same characteristics as the original parts. Unauthorized substitutions may cause a fire, an electric shock or other hazards.

Safety check

Upon completion of repairs to the TV, ask the service technician to perform routine safety checks (as specified by the manufacturer) to determine that the TV is safe for operating, and to so certify. Ask a qualified service technician to dispose of the TV.

For Customers in the United States

There is mercury in the lamp of this product. Disposal of these materials may be regulated due to environmental considerations. For disposal or recycling information, please contact your local authorities or the Electronic Industries Alliance (<http://www.eiae.org>).

Contact ViewSonic service team at: <http://www.ViewSonic.com> or call our service team: United States 1-800-688-6688, Canada 1-866-463-4775

Compliance Information

FCC Statement

This device complies with part 15 of FCC Rules. Operation is subject to the following two conditions: (1) this device may not cause harmful interference, and (2) this device must accept any interference received, including interference that may cause undesired operation.

This equipment has been tested and found to comply with the limits for a Class B digital device, pursuant to part 15 of the FCC Rules. These limits are designed to provide reasonable protection against harmful interference in a residential installation. This equipment generates, uses, and can radiate radio frequency energy, and if not installed and used in accordance with the instructions, may cause harmful interference to radio communications. However, there is no guarantee that interference will not occur in a particular installation. If this equipment does cause harmful interference to radio or television reception, which can be determined by turning the equipment off and on, the user is encouraged to try to correct the interference by one or more of the following measures:

- Reorient or relocate the receiving antenna.
- Increase the separation between the equipment and receiver.
- Connect the equipment into an outlet on a circuit different from that to which the receiver is connected.
- Consult the dealer or an experienced radio/TV technician for help.

Warning: You are cautioned that changes or modifications not expressly approved by the party responsible for compliance could void your authority to operate the equipment.

Following information is only for EU-member states:

The mark shown to the right is in compliance with the Waste Electrical and Electronic Equipment Directive 2002/96/EC (WEEE).

The mark indicates the requirement NOT to dispose the equipment as unsorted municipal waste, but use the return and collection systems according to local law.



ENERGY STAR Information:

- Keeping the TV at its factory default settings that meet ENERGY STAR criteria.
- Enabling certain features and functionality of LCD TV will increase its energy consumption, possibly beyond the limits required for ENERGY STAR qualification.

Contact ViewSonic service team at: <http://www.ViewSonic.com> or call our service team: United States 1-800-688-6688, Canada 1-866-463-4775

Declaration of RoHS Compliance

This product has been designed and manufactured in compliance with Directive 2002/95/EC of the European Parliament and the Council on restriction of the use of certain hazardous substances in electrical and electronic equipment (RoHS Directive) and is deemed to comply with the maximum concentration values issued by the European Technical Adaptation Committee (TAC) as shown below:

Substance	Proposed Maximum Concentration	Actual Concentration
Lead (Pb)	0.1%	< 0.1%
Mercury (Hg)	0.1%	< 0.1%
Cadmium (Cd)	0.01%	< 0.01%
Hexavalent Chromium (Cr ⁶⁺)	0.1%	< 0.1%
Polybrominated biphenyls (PBB)	0.1%	< 0.1%
Polybrominated diphenyl ethers (PBDE)	0.1%	< 0.1%

Certain components of products as stated above are exempted under the Annex of the RoHS Directives as noted below:

Examples of exempted components are:

1. Mercury in compact fluorescent lamps not exceeding 5 mg per lamp and in other lamps not specifically mentioned in the Annex of RoHS Directive.
2. Lead in glass of cathode ray tubes, electronic components, fluorescent tubes, and electronic ceramic parts (e.g. piezoelectronic devices).
3. Lead in high temperature type solders (i.e. lead-based alloys containing 85% by weight or more lead).
4. Lead as an allotting element in steel containing up to 0.35% lead by weight, aluminium containing up to 0.4% lead by weight and as a cooper alloy containing up to 4% lead by weight.

Contact ViewSonic service team at: <http://www.ViewSonic.com> or call our service team: United States 1-800-688-6688, Canada 1-866-463-4775

Getting Started

List of Features

1. Brilliant HDTV. Vibrant PC monitor. One innovative display.
2. Stylish design for kitchen, home office, and dorm room.
3. Super HD 1920x1080 resolution and 1000:1 contrast (typ).
4. PC input for computer applications and web surfing.
5. 6 input including HDMI/DVI for the latest HD devices.

Package Contents

Please make sure the following items are included with your LCD TV.
If any items are missing, please contact your dealer.



LCD TV



Remote Control
with batteries



Power Cord



ViewSonic User Guide

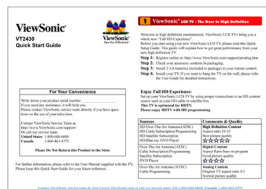

ViewSonic Quick Start Guide

Contact ViewSonic service team at: <http://www.ViewSonic.com> or call our service team: United States 1-800-688-6688, Canada 1-866-463-4775

Installing the LCD TV

Installing the Stand

Figure 1

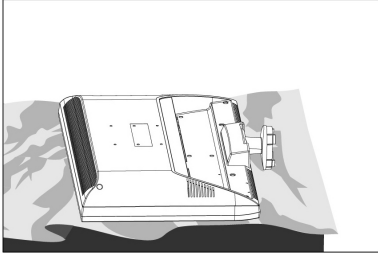

Figure 2

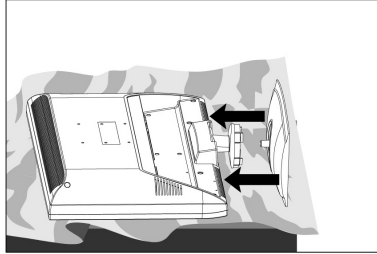
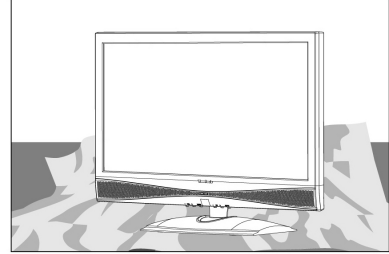

Figure 3



1. Lay the TV flat on a table with the LCD screen face down. To prevent the TV from being scratched, put a piece of soft cloth on the table on which the screen will be set. (see Figure 1)
2. Unpack the stand, one hand hold the TV and one hand pull stand with arm together. (see Figure 2)
3. Stand the TV up. (see Figure 3)

Disconnecting the Stand

Figure 1

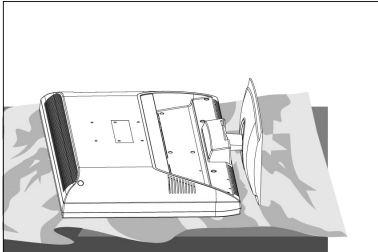

Figure 2

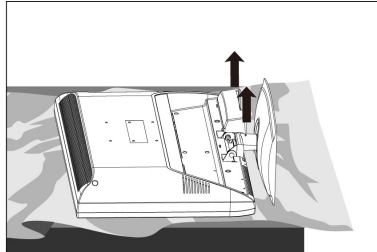

Figure 3

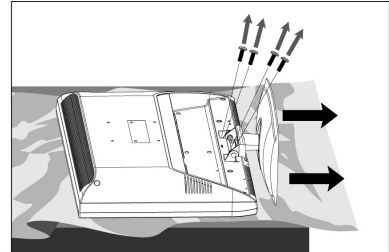
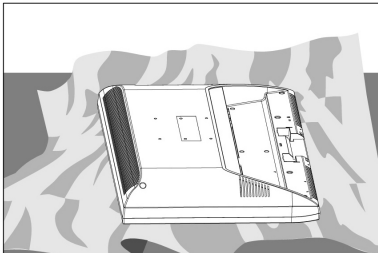

Figure 4



1. Lay the TV flat on a table with the LCD screen face down. To prevent the TV from being scratched, put a piece of soft cloth on the table on which the screen will be set. (see Figure 1)
2. Press on four corners of the hinge cover and pull as arrow direction to disengage the hinge cover. (see Figure 2)
3. Remove the 4 screws on the hinge, then pull up the stand slowly. (see Figure 3)
4. Then, you shall successfully uninstall the stand. (see Figure 4)

Contact ViewSonic service team at: <http://www.ViewSonic.com> or call our service team: United States 1-800-688-6688, Canada 1-866-463-4775

Getting Started

Mounting ViewSonic LCD TV to the wall

The LCD TV can be used in a free standing position or wall-mounted. Before installing the product to the wall, please consider the following guidelines:

- Read the Important Safety Instructions, at the start of this manual.
- Do not install in a moist or wet environment. This equipment is intended for indoor use.
- Do not install near heat source, or strong magnetic fields.
- Use only ViewSonic approved wall-mounting brackets to support the LCD TV weight.
- Before attaching the wall mount plate to the back cover, ensure the product is working.
- If your LCD TV is already set up for free-standing operation, you need to first remove the stand before mounting the device to the wall.

To attach the wall-mount bracket to LCD TV safely, please use the following guidelines:

- Disconnect the power and any other cables that might hinder moving the LCD TV.
- Set the LCD TV on a table or work surface, placing the screen face down on a towel or woolen blanket to protect the screen surface from damage while installing plate.
- Before installing the LCD TV on the wall, ensure you have recorded the product serial number on page (i) of the User Guide, as you will need the serial number to request service should there be a service need.
- Install the wall mount plate to the LCD TV using screws NO LONGER than 10mm, as longer screws found in universal (non-ViewSonic) wall mount kits may damage the power supply causing the unit to fail. The wall-mount screw type is M4 x L10.



- Mount the wall mount bracket to the wall ensuring use of proper screws to support the installation. Ensure there is at least 3cm of space surrounding any air-vents of your LCD TV to allow adequate cooling during operation.
- Hang the LCD TV wall mount plate to the wall mount bracket, completing installation. Enjoy your ViewSonic LCD TV!

Contact ViewSonic service team at: <http://www.ViewSonic.com> or call our service team: United States 1-800-688-6688, Canada 1-866-463-4775

Getting Started

Wall Mount Kit Specifications (VESA)

When attaching to other building materials, please contact your nearest dealer.

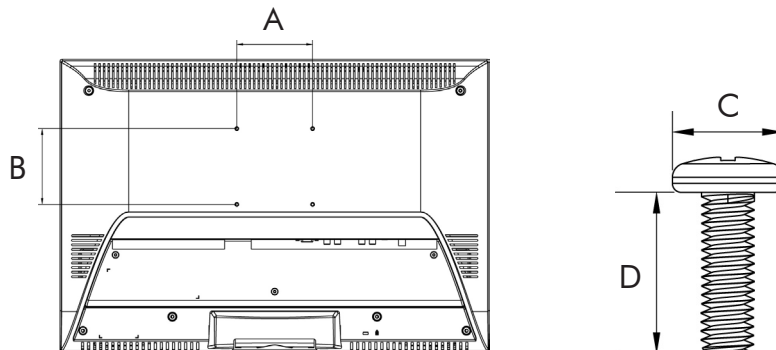

Product Family	inch	VESA Spec. (A x B)	Standard Screw (C x D)	Quantity
LCD TV	16	75 x 75 mm	M4 x L10	4
	19 ~ 24	100 x 100 mm	M4 x L10	4
	26 ~ 27	200 x 100 mm	M4 x L10	6
	32 ~ 37	400 x 200 mm	M6 x L10	6
	42 ~ 47	600 x 200 mm	M6 x L10	10
	52	400 x 200 mm	M6 x L10	6

- ViewSonic provides the standard dimensions for wall mount kits as shown in the table above.
- When purchasing our wall mount kit, a detailed install manual and all parts necessary for assembly are provided.
- Do not use the screws that longer than the standard dimension, as they may cause damage to the inside of the TV set.

Caution

Please use the following ViewSonic TVs only with the following wall-mount kit.

	ViewSonic TV Model No.
	VT2430
ViewSonic Wall-Mount kit model	WMK-10

Use with other Wall-Mount kit may cause instability and possibly result in injury.

To find the perfect mount for VT2430, please browse www.viewsonic.com or call our service team: United States 1-800-688-6688, Canada 1-866-463-4775.

Contact ViewSonic service team at: <http://www.ViewSonic.com> or call our service team: United States 1-800-688-6688, Canada 1-866-463-4775

Front View of the Product

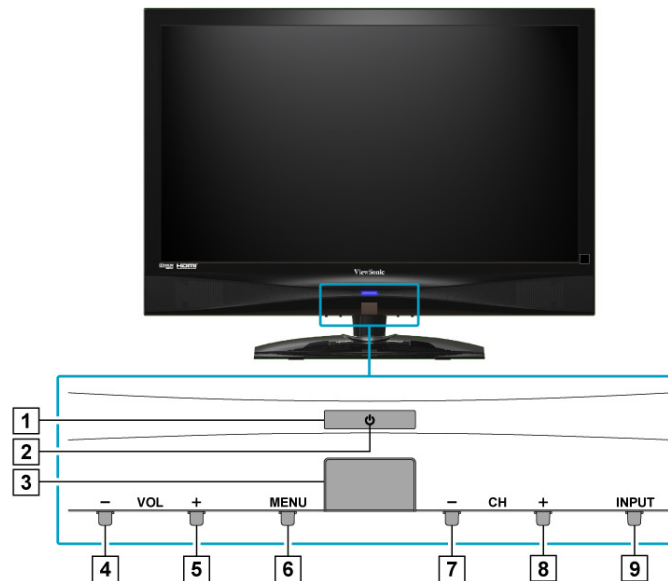

Item	Description
1 Power ON/OFF button	Turn the power on from standby mode or turn the power off to return to the standby mode.
2 Power LED Indicator	Lights up in blue when the TV is turned on. Lights up in orange when the TV is in standby mode.
3 Remote Control Receiver	Receives IR signals from the remote control.
4 Volume Down	Decrease sound volume or adjust a highlighted control while in OSD menu.
5 Volume Up	Increase sound volume or adjust a highlighted control while in OSD menu.
6 MENU	Turn OSD menu ON/OFF.
7 CH Down	Channel down when source is TV, or select a control while in OSD menu.
8 CH Up	Channel up when source is TV, or select a control while in OSD menu.
9 INPUT	Select input source.

Contact ViewSonic service team at: <http://www.ViewSonic.com> or call our service team: United States 1-800-688-6688, Canada 1-866-463-4775

Rear View of the Product

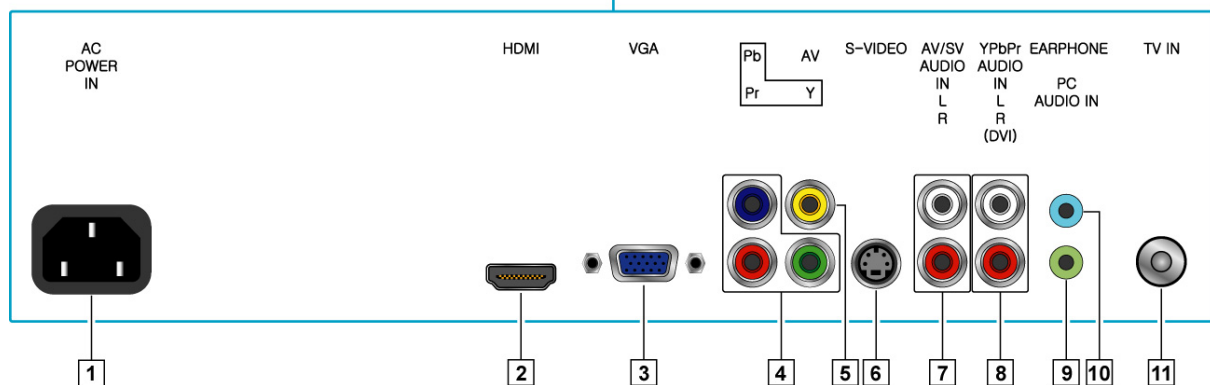
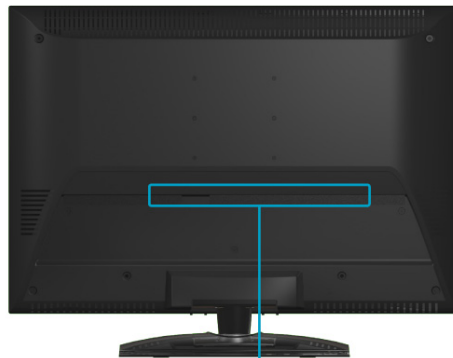

Item	Description
1 Power (AC input)	Plug-in the supplied AC Power cord and connect to the AC input power source.
2 HDMI Input Terminal	Connect this port to the HDMI/HDMI-DVI jack of the compatible equipment.
3 VGA signal input	Connect a 15-pin D-sub RGB cable to the RGB output of your computer and the other end to the RGB input on the rear of the LCD TV.
4 YPbPr signal input	Connect this jack to the YPbPr output of A/V device.
5 Composite Video input	Connect this jack to the composite video output connectors on your A/V equipment.
6 S-Video input	Connect the S-Video cable from the compatible device to this connector on the rear panel of the LCD TV.
7 AV/ S-Video Audio input (left/ right)	Connect the Audio in cable for AV/ S-Video from this jack to the corresponding connectors on your A/V device.
8 YPbPr/ DVI Audio input (left/ right)	Connect the Audio in cable for YPbPr/ HDMI-DVI from this jack to the corresponding connectors on your A/V device.
9 PC Audio input	Connect the RGB Audio Out on your computer to the RGB Audio on the rear of the LCD TV.

Contact ViewSonic service team at: <http://www.ViewSonic.com> or call our service team: United States 1-800-688-6688, Canada 1-866-463-4775

Getting Started

Item	Description
10 Headphone Jack	Connect to your headphones. By connecting the headphones, you can listen to the sound from the TV on headphones. * If you connect the headphones, the TV speakers will be muted.
11 TV Input Jack	Connect this jack to your Cable or VHF/UHF antenna.

AV connection

Connect the composite video and audio input jacks to the corresponding output jacks of your A/V device.

--- VIDEO: Composite Video input [5]

--- AUDIO: AV/ S-Video signal Audio input [7]

S-Video connection

Connect the S-Video and audio input jacks to the corresponding output jacks of your VCR or other video device that has S-Video. S-Video provides better picture quality than composite video connection. If both are connected, S-Video signal has priority.

--- VIDEO: S-Video input [6]

--- AUDIO: AV/ S-Video signal Audio input [7]

Component (YPbPr) connection

YPbPr provides better picture quality than the S-Video or the AV connection.

* For YPbPr connection, connect the component video (YPbPr) and audio jacks to the corresponding output jacks of your A/V device.

--- VIDEO: YPbPr signal input [4]

--- AUDIO: YPbPr/DVI signal audio input [8]

HDMI connection

HDMI (High-Definition Multimedia Interface) is a licensable audio/video connector interface for transmitting uncompressed, encrypted digital streams between this TV and any HDMI-equipped audio/video equipment.

* Be sure to use only an HDMI cable that bears the HDMI logo.

* If the equipment has a DVI jack and not an HDMI jack, connect the DVI jack to the HDMI Input Terminal (with DVI-to-HDMI cable or adapter), and connect the Audio cable to the Audio In jacks.

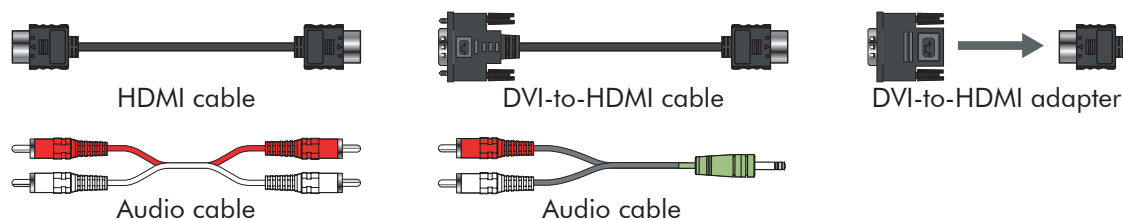

1. With HDMI cable: HDMI Input Terminal [2]

2. With HDMI-DVI cable --- VIDEO: HDMI Input Terminal [2]

--- AUDIO: YPbPr/ DVI signal Audio input [8]

Computer connection

Connect the VGA cable and Audio cable from the VGA signal input and PC Audio input to the corresponding ports on your A/V device.

--- VIDEO: VGA signal input [3]

--- AUDIO: PC Audio input [9]

Contact ViewSonic service team at: <http://www.ViewSonic.com> or call our service team: United States 1-800-688-6688, Canada 1-866-463-4775

Connecting the LCD TV

Cable System or VHF/UHF Antenna System

Enjoy the high-definition and standard-definition digital programming along with standard-definition analog programming.



- This TV is capable of receiving unscrambled digital programming for both cable and external VHF/UHF antenna.
- We strongly recommend that you connect the antenna/cable input using a 75-ohm coaxial cable (not supplied) to ensure the best picture quality.

Cable or VHF/UHF



Cable System and VHF/UHF Antenna System

Use an optional A-B RF switch (not supplied) to switch between the cable and antenna programming, as shown below.

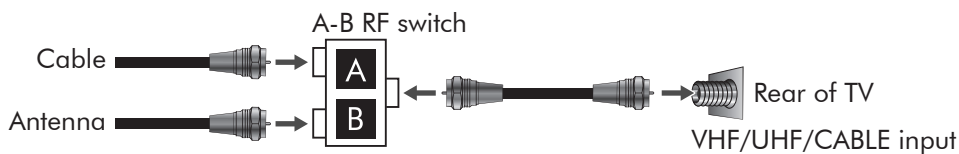

- Remember to set the TV/CATV setting in the TV menu to Air or Cable for the type you choose.

HD Cable Box/HD Satellite Box

You can also enjoy high-definition programming by subscribing to a high-definition cable service or a high-definition satellite service. For the optimum picture quality, be sure to connect this device to your TV via the HDMI or component video (with audio) input on the back of your LCD TV.

HDMI Connection

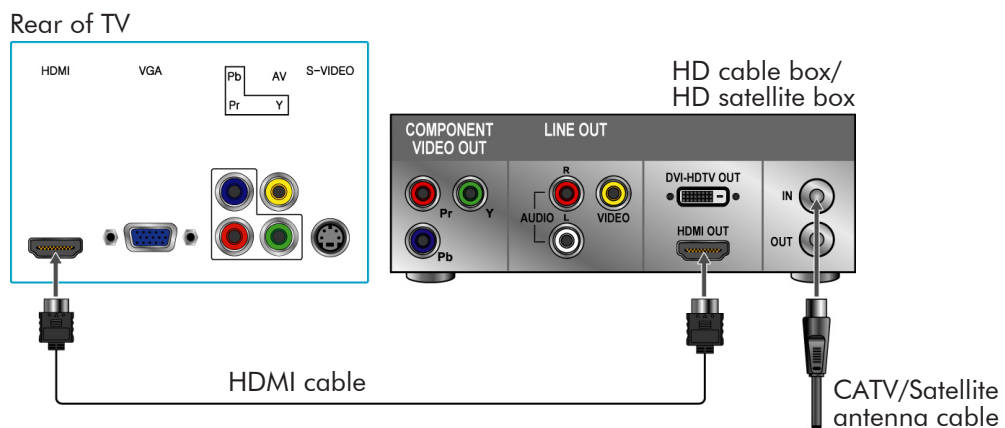

Contact ViewSonic service team at: <http://www.ViewSonic.com> or call our service team: United States 1-800-688-6688, Canada 1-866-463-4775

Getting Started

DVI Connection

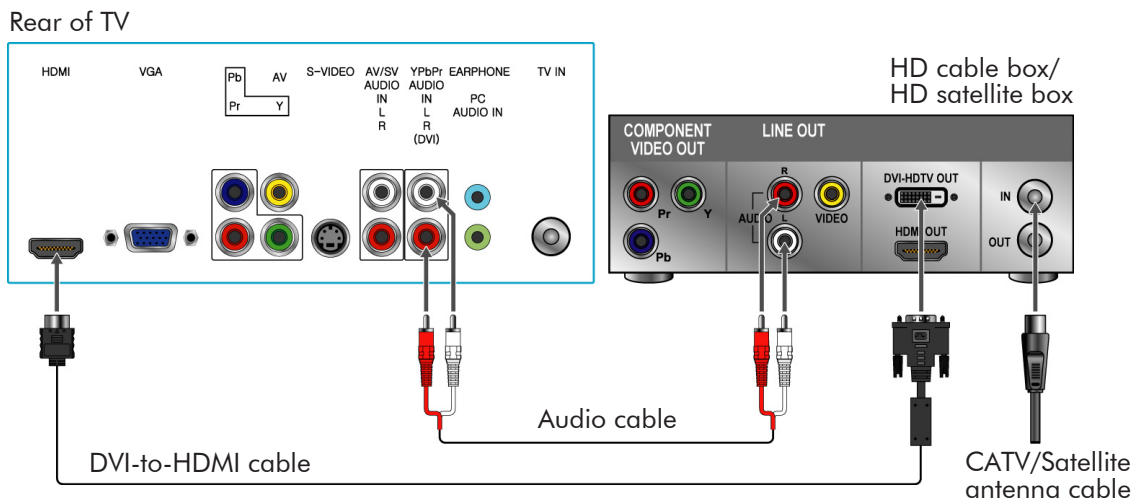

- If the equipment has a DVI jack and not an HDMI jack, connect the DVI jack to the HDMI jack [2] and connect the audio jack to the AUDIO In jacks of HDMI [8].

YPbPr or Component Connection

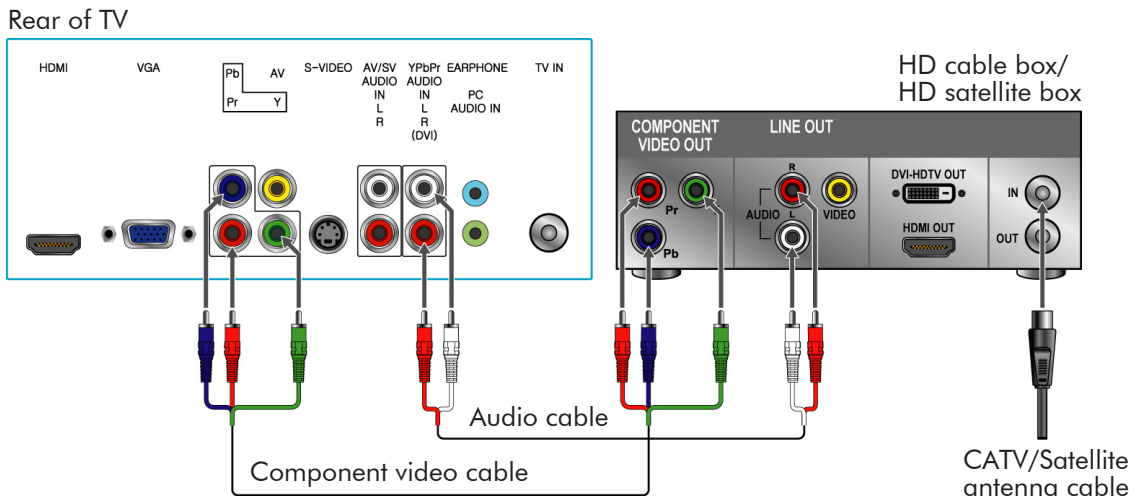

Contact ViewSonic service team at: <http://www.ViewSonic.com> or call our service team: United States 1-800-688-6688, Canada 1-866-463-4775

Getting Started

Personal Computer

Use the LCD TV as the monitor of your computer.

The picture below shows the connection for PC. The LCD TV can also be connected to PC with DVI or HDMI output.

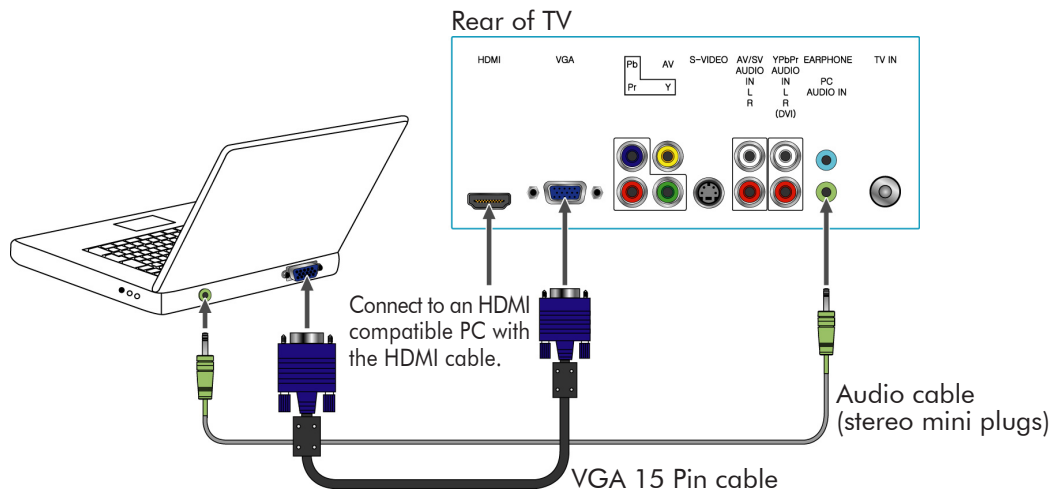

- Connect the PC IN jack to the PC using a 15-pin cable and audio cable.
- If the PC is connected to TV and no signal has been input from PC for more than 5 seconds, the TV will enter standby mode automatically.

PC Timing Reference Chart

Mode		Aspect Ratio Handling	Compatible Input
Standard	Resolution	FS*Full-Screen	RGB
	720 x 400 @ 70Hz	1920 x 1080	Yes
VESA	640 x 480 @ 60Hz	1920 x 1080	Yes
VESA	640 x 480 @ 75Hz	1920 x 1080	Yes
VESA	800 x 600 @ 60Hz	1920 x 1080	Yes
VESA	800 x 600 @ 75Hz	1920 x 1080	Yes
MAC	832 x 624 @ 75Hz	1920 x 1080	Yes
VESA	1024 x 768 @ 60Hz	1920 x 1080	Yes
VESA	1024 x 768 @ 75Hz	1920 x 1080	Yes
VESA	1280 x 768 @ 60Hz	1920 x 1080	Yes
VESA	1280 x 1024 @ 60Hz	1920 x 1080	Yes
VESA	1440 x 900 @ 60Hz	1920 x 1080	Yes
VESA	1680 x 1050 @ 60Hz	1920 x 1080	Yes
VESA	1920 x 1080 @ 60Hz	1920 x 1080	Yes



- This TV's PC VGA input does not support interlaced signals.
- For the best picture quality, we recommend that you use the signals (boldfaced) in the above chart with a 60 Hz vertical frequency from a personal computer.

Contact ViewSonic service team at: <http://www.ViewSonic.com> or call our service team: United States 1-800-688-6688, Canada 1-866-463-4775

Getting Started

Other Equipment

ENGLISH

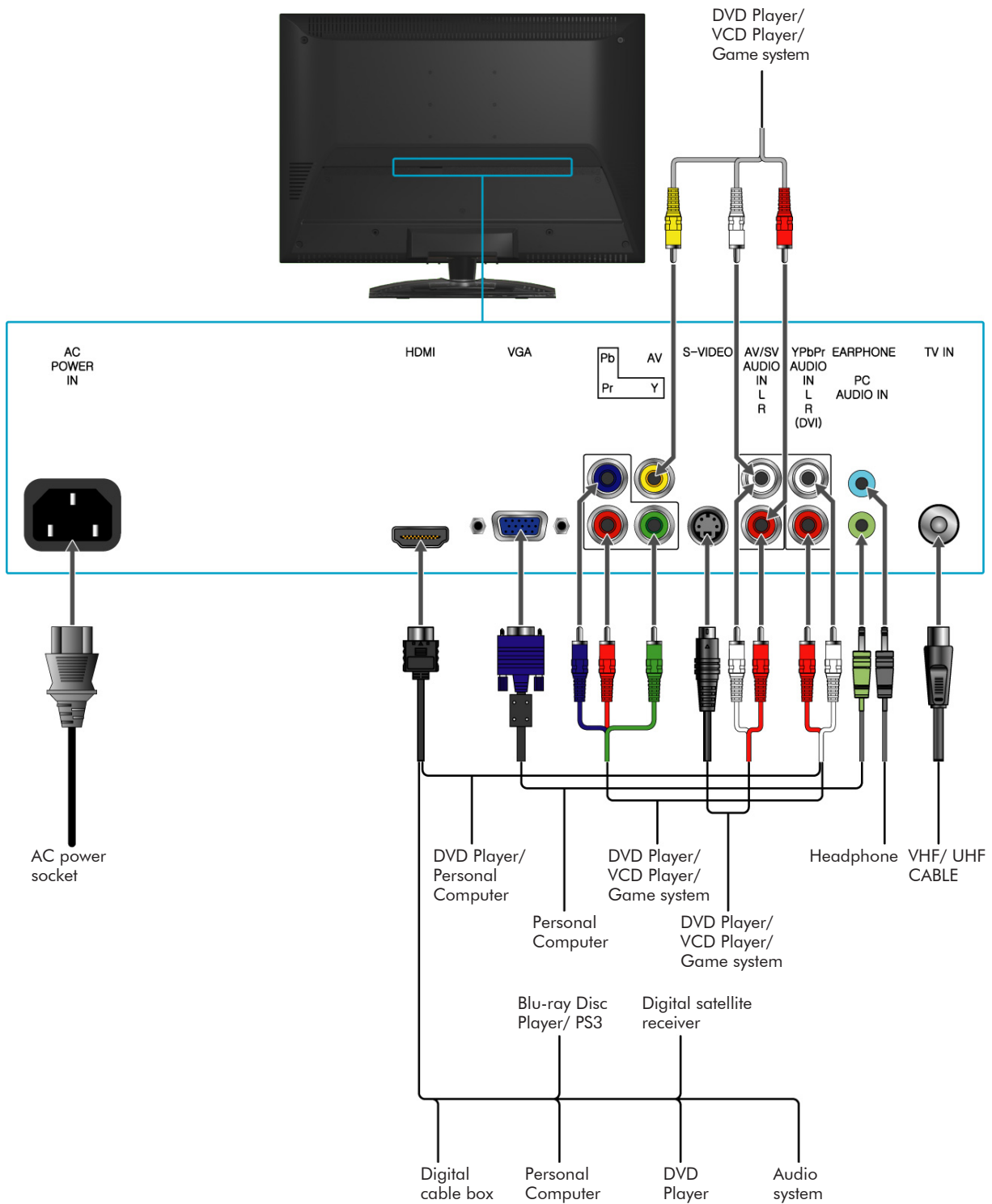

- Please refer to the Quick Start Guide (supplied) when connecting the other equipment to your LCD TV.

Contact ViewSonic service team at: <http://www.ViewSonic.com> or call our service team: United States 1-800-688-6688, Canada 1-866-463-4775

Using the TV Features

Remote Control and TV Controls

Inserting Remote Control Batteries

1. Remove the battery cover by pulling then lifting the knob on the cover.
2. Insert the batteries, corresponding to the (+) and (-) markings on the battery compartment.
3. Reattach the battery cover.



⚠ CAUTION

- Only use the specified AA batteries.
- Do not mix new and old batteries. This may result in creaking or leakage, which may pose a risk of fire or lead to personal injury.
- Insert batteries according to (+) and (-) markings. Inserting the batteries incorrectly may result in leakage, which may pose a risk of fire or lead to personal injury.
- Dispose of the battery in accordance with local laws and regulations.
- Keep the batteries away from children or pets.
- When the remote control will not be used for an extended period, remove the batteries.

Remote Control and TV Controls

Buttons located at the bottom of the LCD TV will operate the same as these buttons on the remote control.

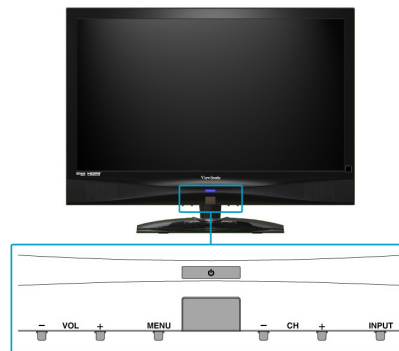
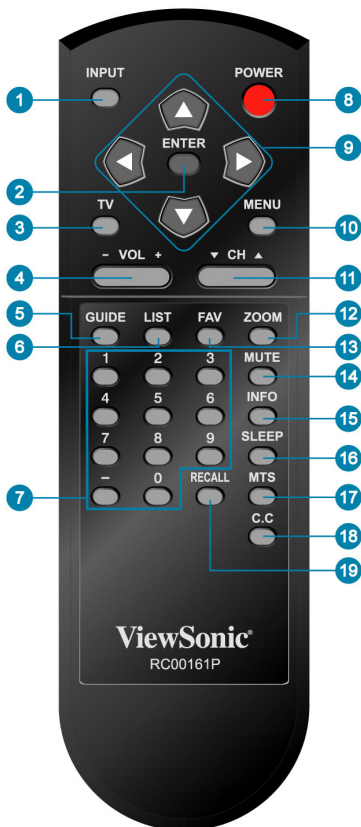

Button	Description
1 INPUT	Press to display the INPUT source list and select the source with ▲/▼ buttons. To confirm the selection, press ENTER.

Contact ViewSonic service team at: <http://www.ViewSonic.com> or call our service team: United States 1-800-688-6688, Canada 1-866-463-4775

Using the TV Features

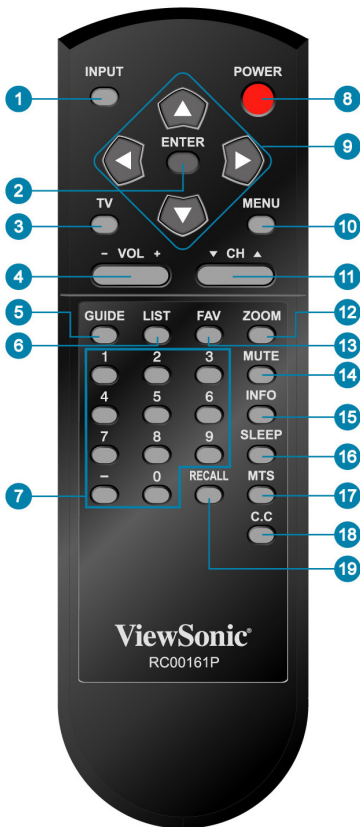

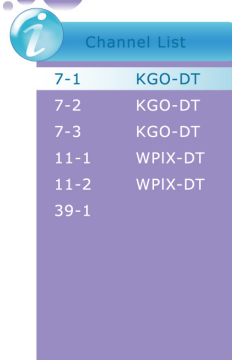
Button	Description
2 ENTER	Press to confirm the selection in the OSD menu, or to enter the OSD menu you select. Press ENTER after you input channel numbers will change channels immediately.
3 TV	Press to direct to TV source when in any other source.
4 - VOL +	Press to adjust the volume.
5 GUIDE	Press to display the Electronic Program Guide (EPG). It contains the program information for the channel you're watching. 
6 LIST	Press this button to show a small window showing program list, you can scroll through the list to select the channel you want directly without using the ▲/▼ button. 
7 0~9, - number buttons	Press 0~9 and “-” to select a channel. After you input the channel numbers, press ENTER button to direct to the channel immediately, or wait for 3 seconds to change automatically.
8 POWER	Press this button to turn the power on from standby mode. Press it again to return to the standby mode.
9 ▲▼◀▶ buttons	Press these buttons to navigate the OSD menus. ▲/▼ is for function select, and ◀/▶ is for function adjustment.

Contact ViewSonic service team at: <http://www.ViewSonic.com> or call our service team: United States 1-800-688-6688, Canada 1-866-463-4775

Using the TV Features

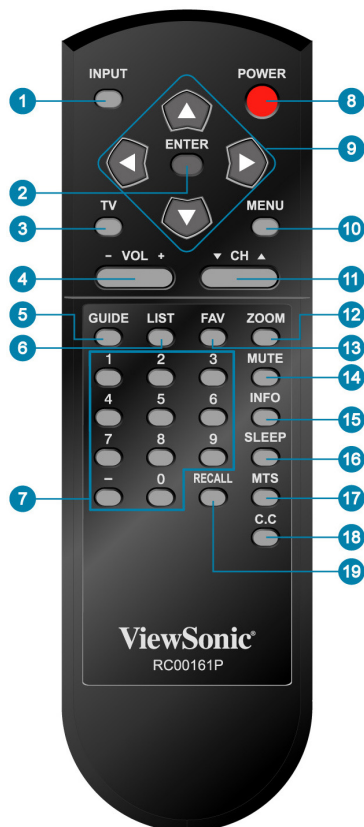

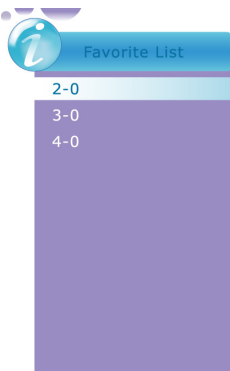
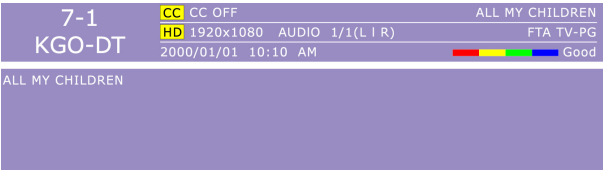
Button	Description
10 MENU	Press to turn the OSD (On-Screen Display) menu on.
11 ▼ CH ▲	Press to change the channels up or down.
12 ZOOM	Press this button repeatedly to select the screen size. You can select from Full, 4:3, Movie Scale, and Zoom In. *The digital TV HD signal is available in Full and 4:3.
13 FAV	Press this button to show Favorite List and select your favorite channels that have already been stored.
	
14 MUTE	Press to turn off the sound. To restore the sound, press this button again, or press the VOL+ button.
15 INFO	Press this button to display the current state of the LCD TV.
	
16 SLEEP	Press repeatedly to set the off timer. The function is used to automatically shut off the LCD TV after a preset period of time passed. There are several times for choice – Off, 5 Min, 10 Min, 15 Min, 30 Min, 45 Min, 60 Min, 90 Min, 120 Min, 180 Min, 240 Min.
17 MTS	Press this button to choose the available sound output that is preset by TV broadcasting station. (EX: Mono, Stereo, SAP)
18 C.C	Press to select the Closed Caption menu in the TV mode.
19 RECALL	Press to return to previous channel.

Contact ViewSonic service team at: <http://www.ViewSonic.com> or call our service team: United States 1-800-688-6688, Canada 1-866-463-4775

Using the TV Features

Operation

Turning the TV On and Off

Press the **POWER** button on the remote control.
You can also use the Power button on the front of the panel.

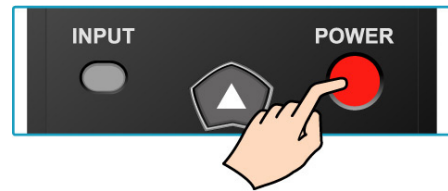

Changing Channels

1. Using Channel Buttons

Press **▼CH▲** button to change channels, and the TV changes channels in sequence. You will see all channels that have been memorized. Channels erased or not memorized will not be shown.



2. Using Number Buttons

(1) ATV

The “-” button has no function in ATV mode. Directly press the number buttons to select channels.

(2) DTV

Use “-” button to select the sub channel in DTV.

Ex: Your desired number is 80-3.

Press **8** → press **0** → press “-” → press **3**.

* Return to the previous channel, press **RECALL** button.

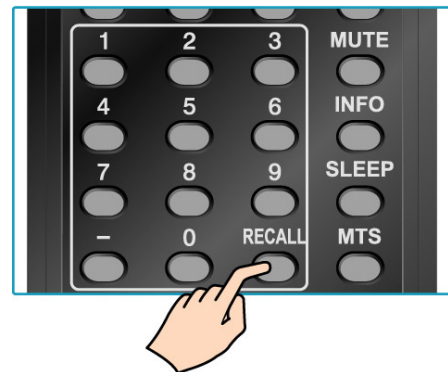

Adjusting the Volume

Press **VOL +/-** to adjust volume.

To turn off the volume, press **MUTE**.

To restore volume, press **MUTE** again, or press **VOL +/-** directly.

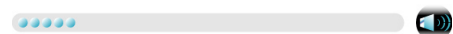

Viewing the Displayed Information

To display the current information of the LCD TV:

Press **INFO**, and the current state will be displayed on the screen. (It shows all or some of the information about Input, Channel, Resolution, Audio Type, etc., depending on what input source it is in)

* The picture here shows an example of the INFO screen in a DTV source.

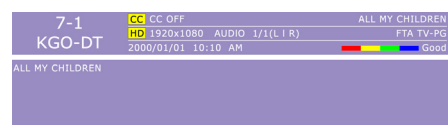
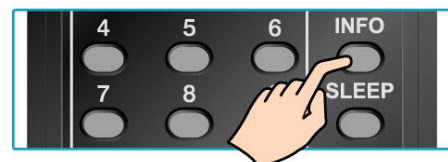

Contact ViewSonic service team at: <http://www.ViewSonic.com> or call our service team: United States 1-800-688-6688, Canada 1-866-463-4775

Using the TV Features

Storing Channels into Memory

1. Press the **MENU** button to display the OSD main menu.
2. Press ◀ or ▶ to select the “CHANNEL” menu.
Press ▲ or ▼ to select “TV Source”, and use ◀ or ▶ to select the antenna connection to “Air” or “Cable”.
Air: RF signal programs by “Air”.
Cable: RF signal programs by “Cable”.
3. Press ▲ or ▼ to select “Auto Scan”, then press ▶ to enter.
4. Press ▲ or ▼ to select “Scan all channels”, “Digital channel only”, or “Analog channel only” and press ▶ to perform Auto Scan function.
To stop scanning, press **MENU** at any time.
5. The Auto Scan screen will be shown, and after it is done, the screen will return to the first found channel.



Viewing the Menus

1. Press the **MENU** button to display the OSD main menu.
There are six top menus on the screen: PICTURE, AUDIO, TIME, OPTION, LOCK, and CHANNEL.
2. Press ◀ or ▶ to select your desired top menu.
3. Press **ENTER** or ▼ to enter the menu you select.
4. Use ▲ ▼ to select the control you want to adjust.
5. When selecting the control with ▶, press ▶ to enter next level menu or enable the function. (▶ will only appear when the control is highlighted)
6. Press ◀▶ to adjust or select the settings.
7. Press **MENU** to exit from the OSD menu.



Contact ViewSonic service team at: <http://www.ViewSonic.com> or call our service team: United States 1-800-688-6688, Canada 1-866-463-4775

Using the TV Features

Selecting the Input Source

To select the TV or other external input sources connected to the TV.

1. Press the **INPUT** button on the remote control.
2. Press **▲** or **▼** to select the required input source between TV, AV, S-Video, YPbPr, HDMI, or PC.
3. To confirm the selection, press **ENTER**.



Favorite Channel Setting

To set your favorite channel into memory:

1. Press the **MENU** button to display the OSD main menu.
2. Press **◀** or **▶** to select the “CHANNEL” menu.
Press **▲** or **▼** to select “Favorite”, then press **▶** button to enter “Favorite” setting.
3. Press **▲** or **▼** to select the channel you'd like to be your favorite channel.
Press **ENTER** to confirm your selection.
4. To cancel the selection, Press **ENTER** again on the selected channel.
5. Press **MENU** to exit.

*To view your favorite channels, press **FAV** button to show Favorite List and select your favorite channels that have already been stored.



Using the TV Features

Adding/Erasing Channel

When the channel is erased, it will not appear on the screen when you browse the channels with **▼CH▲** button. To see the channel again, you must add the channel or perform the “Auto Scan” (page 25) function again.

1. Press the **MENU** button to display the OSD main menu.
2. Press **◀** or **▶** to select the “TV” menu.
Press **▲** or **▼** to select “Show/Hide”, then press **▶** button to enter “Show/Hide” setting.
3. Press **▲** or **▼** to select the channel you want to Show/Hide, and check or uncheck it with **ENTER** button.
4. Press **MENU** to exit.



Channel Name Setting

To edit a name for the current channel:

1. Press the **MENU** button to display the OSD main menu.
2. Press **◀** or **▶** to select the “CHANNEL” menu.
3. Press **▲** or **▼** to select “Channel No.”, then press **◀** or **▶** to select the channel you want to edit the name.
4. Press **▲** or **▼** to select “Channel Label”, then press **▶** button to enter “Channel Label” setting.
5. Use **▲** or **▼** to choose letters or signs, **◀** or **▶** to move forward or backward.
6. After you input the channel name, press **MENU** or **ENTER** to complete the setting.
7. Press **MENU** to exit.

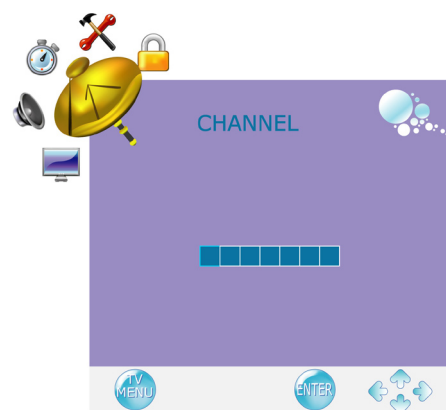
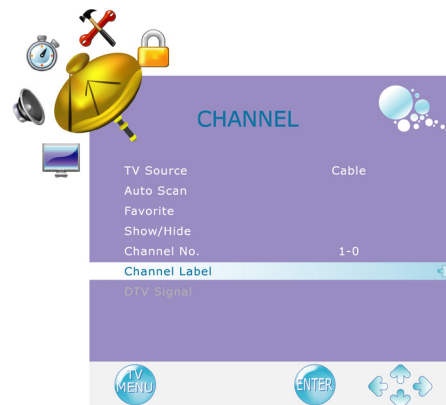

Contact ViewSonic service team at: <http://www.ViewSonic.com> or call our service team: United States 1-800-688-6688, Canada 1-866-463-4775

Using the TV Features

Adjusting the Settings

1.

- (1) Press the **MENU** button to display the OSD main menu.
- (2) Press ◀ or ▶ to select your desired top Menu.
- (3) Press ▲ or ▼ to select the control of “Contrast”, “Brightness”, “Sharpness”, “Tint”, “Color”, then press ◀ or ▶ to adjust the level.
- (4) Press **MENU** to exit.

2.

- (1) Press the **MENU** button to display the OSD main menu.
- (2) Press ◀ or ▶ to select your desired top Menu.
- (3) Press ▲ or ▼ to select the control of “Picture Mode”, “Color Mode”, “Zoom Mode”, “Noise Reduction”, “Sound Mode”, “MTS”, “Prefer Language” (in DTV mode), “Surround Sound”, “Audio Only”, “Sleep Timer”, “Time Zone”, “DST”, “Time Format”, “Auto Sync”, “Clock”, “Menu Language”, “Transparency”, “OSD Time Out”, “DCR” (Dynamic Contrast Ratio), then press ◀ or ▶ to select your desired option.
- (4) Press **MENU** to exit.

3.

- (1) Press the **MENU** button to display the OSD main menu.
- (2) Press ◀ or ▶ to select your desired top Menu.
- (3) Press ▲ or ▼ to select the control with ▶, including “Treble/Bass”, “Closed Caption”, “Restore Default”, then press ▶ to perform the function or enter detailed settings.

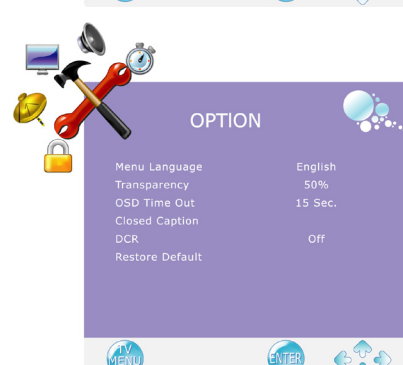
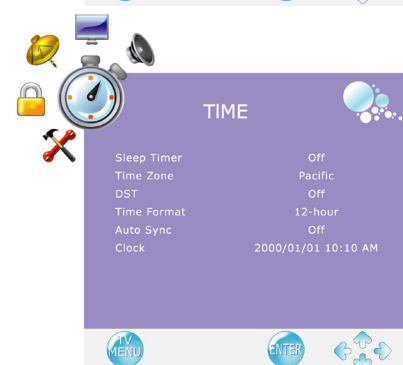
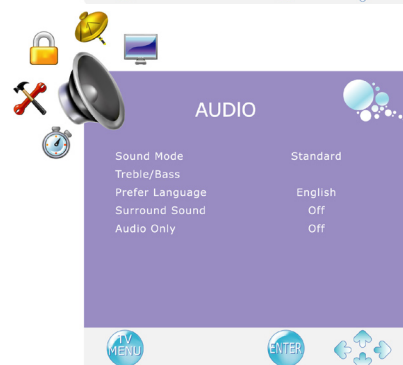

Contact ViewSonic service team at: <http://www.ViewSonic.com> or call our service team: United States 1-800-688-6688, Canada 1-866-463-4775

Using the TV Features

Setting up Time menu

1. Press the **MENU** button to display the OSD main menu.
2. Press ◀ or ▶ to select the “TIME” menu.
3. Press ▲ or ▼ to select “Sleep Timer”, and press ◀ or ▶ to set the “Sleep Timer” from 5~240 min, or Off.
4. Press ▲ or ▼ to select “Time Zone”, and select the correct time zone of your area with ◀ or ▶. The displayed time of “Clock” will be changed at the same time automatically. To adjust “Clock”, select “Clock” and press ▶. Use ◀ or ▶ to change between year/ month/ date/ hour/ minute, ▲ or ▼ to adjust. When you finish adjustment, select “OK” and press ENTER to complete the setting.
* The “Clock” time can only be adjusted manually when “Auto Sync” is set to “Off”.
5. Press ▲ or ▼ to select “DST” (Daylight Saving Time), and select On or Off with ◀ or ▶ according to the time zone of your area. The “Clock” time will change automatically.
6. Press ▲ or ▼ to select “Time Format”, and ◀ or ▶ to select 12-hour or 24-hour.
7. Press **MENU** to exit.



Closed Caption Setting

1. Press the **MENU** button to display the OSD main menu.
2. Press ◀ or ▶ to select the “OPTION” menu.
Press ▲ or ▼ to select “Closed Caption”, then press ▶ button to enter “Closed Caption” setting.
3. Press ▲ or ▼ to select CC Mode, Basic Selection, or Advanced Selection, and use ◀ or ▶ to make your choice.
Basic Selection: To set basic analog closed caption options. (CC1~CC4, TEXT1~TEXT4, Off)
Advanced Selection: To select closed caption signal formats and set up caption modes for digital TV channels. (Service1~6, Off)

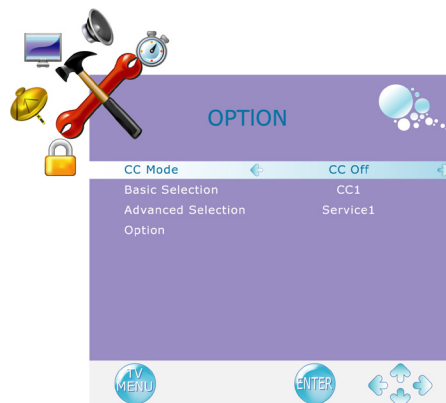
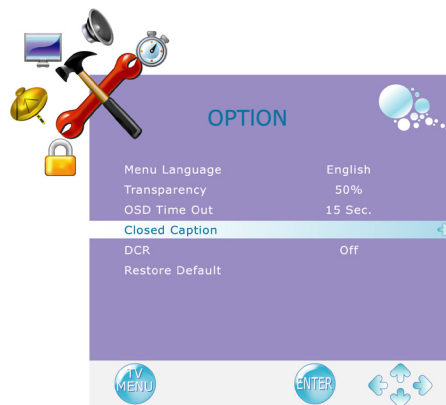

Contact ViewSonic service team at: <http://www.ViewSonic.com> or call our service team: United States 1-800-688-6688, Canada 1-866-463-4775

Using the TV Features

For detailed Close Caption setting:

1. Press ▲ or ▼ to select “Option”, then press ► to enter “Option” setting.
2. Press ◀ or ▶ to select the Mode to be “Custom”, and then use ▲ or ▼ to select desired options and use ◀ or ▶ to adjust detailed settings.

* When you select the Mode to be “Default”, you can not adjust the detailed settings.

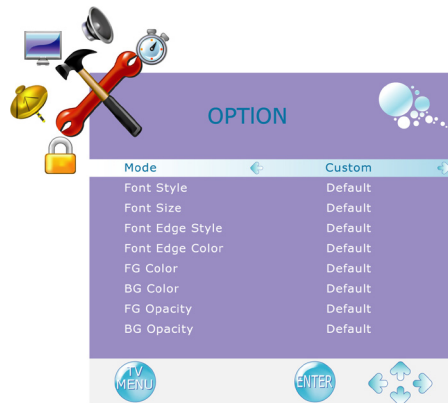
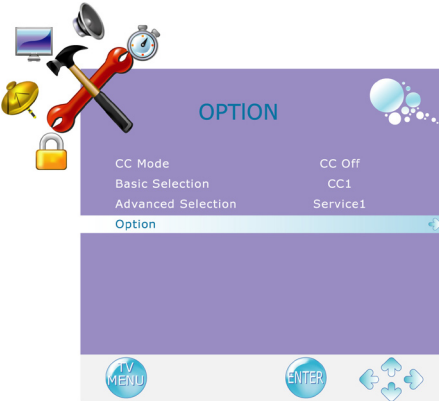

Using the Parent Controls

1. Press the **MENU** button to display the OSD main menu.
2. Press ◀ or ▶ to select the “LOCK” menu.
3. Press **ENTER** or ▼ to enter Password.
4. Enter the password. (The default password is 0000)
5. Move to “System Lock”, and select “On” to enable the detailed settings.
6. Move to “US” or “Canada” rating system.



Contact ViewSonic service team at: <http://www.ViewSonic.com> or call our service team: United States 1-800-688-6688, Canada 1-866-463-4775

Using the TV Features

US: Press ► to set TV or MPAA ratings.

(1) TV

1. Press ▲ or ▼ to select “TV”, then press ► to enter “TV” rating system setting.

The following screen will allow you to customize the following TV ratings:

- Y** (all children)
- Y7** (older children)
- G** (general audience)
- PG** (guidance suggested)
- 14** (strongly cautioned)
- MA** (mature audience)

You can also customize the TV ratings for the following content:

- ALL** (All types content)
- FV** (fantasy violence)
- V** (violence)
- S** (sexual situations)
- L** (adult language)
- D** (sexual dialog)

2. Press **ENTER** to set or reset each area.
3. Press **MENU** to exit.

(2) MPAA

1. Press ▲ or ▼ to select “MPAA”.
2. Press ▲ or ▼ to select your desired MPAA ratings level.

The MPAA ratings level are defined as following:

- G** (general audience)
- PG** (parental guidance suggested)
- PG-13** (recommended for children 14 years of age or older)
- R** (mature audience)
- NC-17** (no one under 17 years of age)
- X** (adult audience only)
- N/A** (not applicable)

3. Press **MENU** to exit.

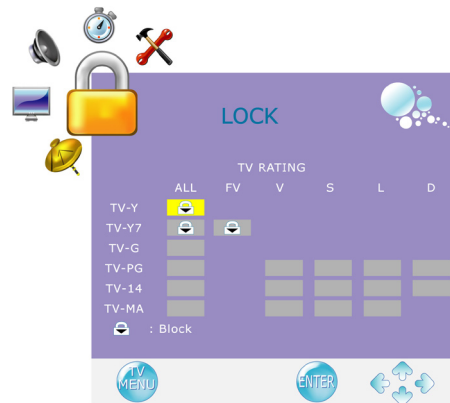

Using the TV Features

Canada: Press ► to set Canadian English and French ratings.

(1) Canadian English

1. Press ▲ or ▼ to select “Canada Eng”.
2. Press ► to enter.
3. Press ▲ or ▼ to select your desired Canadian English rating level.

The Canadian English rating levels are defined as following:

C (children)

C8+ (children eight years and older)

G (general programming, suitable for all audiences)

PG (parental guidance)

14+ (viewers and older)

18+ (adult programming)

EXEMPT (exempt)

4. Press **MENU** to exit.

(2) Canadian French

1. Press ▲ or ▼ to select “Canada Fre”.
2. Press ► to enter.
3. Press ▲ or ▼ to select your desired Canadian French rating level.

The Canadian French rating levels are defined as following:

G (general)

8ans+ (children eight years and older)

13ans+ (not appropriate for children of less than 13 years)

16ans+ (not appropriate for children of less than 16 years)

18ans+ (reserved to adults)

EXEMPT (exempt)

4. Press **MENU** to exit.



Using the TV Features

To Block Unrated Movie or TV Programs

1. Press ▲ or ▼ to select “Unrated Lock”, then press ◀ or ▶ to select “On” or “Off”. When “On” is selected, all programs that are not rated will be blocked.
2. Press MENU to exit.



To Set Rating Region Table

RRT Setting defines the rating standard for a particular geographic region and/ or country.

1. Press ▲ or ▼ to select “RRT Setting”, then press ▶ to enter RRT setting.
2. Select each adjustable setting with ▲ or ▼, then press ◀ or ▶ to select the sub-selection.
3. Press MENU to exit.

*The picture here only shows an example of the content of RRT Setting. However, the selections and sub-selections of RRT Setting may be different in your OSD menu according to the local broadcasting system.

*To reset RRT setting, move to “Reset RRT”, and press ▶ to reset.



To Change Password

1. Press ▲ or ▼ to select “Change Password”, then press ▶ to enter “Change Password” setting.
2. Move to “Enter Old Password”, then enter the old password with number keys.
3. Enter your new password on “Enter New Password”.
4. Enter your new password again on “Confirm Password”.

After you complete the last step, the screen will return to the top page of LOCK menu. If so, the password has been changed successfully.



Contact ViewSonic service team at: <http://www.ViewSonic.com> or call our service team: United States 1-800-688-6688, Canada 1-866-463-4775

Using the TV Features

To block by Input Source

1. Press ▲ or ▼ to select “Input Block”.
2. Press ▲ or ▼ to select the input source, then ◀ or ▶ to select from “Block” or “UnBlock”.
3. Press **MENU** to exit.



To Restore Factory Setting

1. Press the **MENU** button to display the OSD main menu.
2. Press ▲ or ▼ to select the “OPTION” menu.
3. Press **ENTER** or ▶ to enter “OPTION” menu.
4. Press ▲ or ▼ to select “Restore Default”, then press ▶ to restore the factory default setting.
5. Select “Yes” and press **ENTER** to confirm the setting.

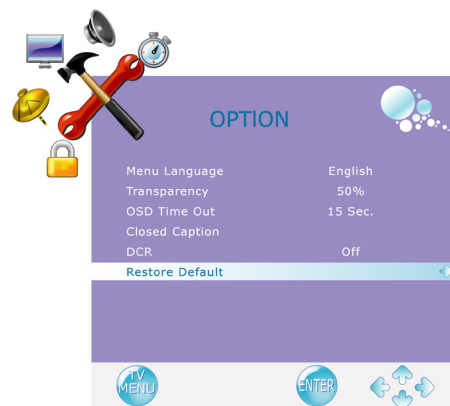

Contact ViewSonic service team at: <http://www.ViewSonic.com> or call our service team: United States 1-800-688-6688, Canada 1-866-463-4775

Using the TV Features

Using PC Function

1. When in PC source, press the **MENU** button to display the OSD main menu.
2. Press ◀ or ▶ to select the “PICTURE” menu.
3. Press ▲ or ▼ to select your desired controls, and press ◀ or ▶ to adjust.
4. For advanced PC functions, select “Advanced” (only in PC source) and press ▶ to enter.
5. Press ▲ or ▼ to select “Auto” (Auto adjustment), “H-Pos” (H-Position), “V-Pos” (V-Position), “Clock” or “Phase”, and adjust the level with ◀ or ▶.

* When in PC source, the other menus are the same as or similar to when in other source.

* When there is no signal in the PC mode, “No Signal” will be displayed on the screen and the TV will automatically turn into power-saving mode after a few seconds’ idleness. Press **INPUT** or **POWER** button on the remote control and the TV will return to VGA mode.

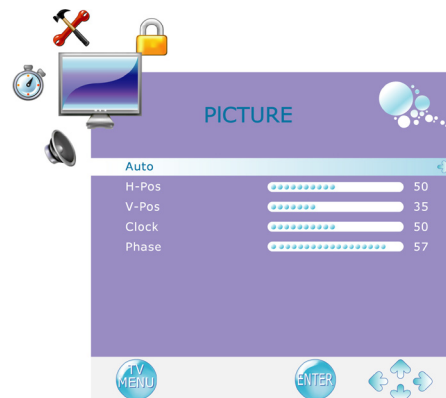
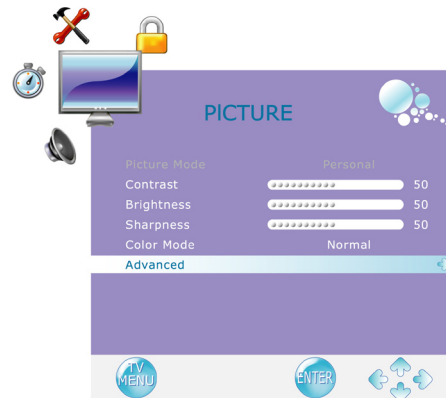
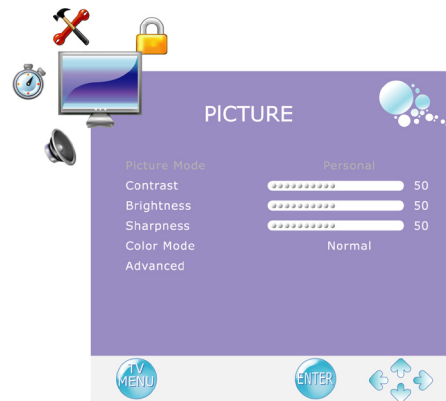

Other Information

Cleaning the LCD TV

- Make sure the LCD TV is turned off.
- Never spray or pour any liquid directly onto the screen or case.

To clean the screen:

1. Wipe the screen with a clean, soft, lint-free cloth. This removes dust and other particles.
2. If still not clean, apply a small amount of non-ammonia, non-alcohol based glass cleaner onto a clean, soft, lint-free cloth, and wipe the screen.

To clean the case:

1. Use a soft, dry cloth.
2. If still not clean, apply a small amount of a non-ammonia, non-alcohol based, mild non-abrasive detergent onto a clean, soft, lint-free cloth, then wipe the surface.

Disclaimer

ViewSonic® does not recommend the use of any ammonia or alcohol-based cleaners on the LCD TV screen or case. Some chemical cleaners have been reported to damage the screen and/or case of the LCD TV. ViewSonic will not be liable for damage resulting from use of any ammonia or alcohol-based cleaners.

Programming your Cable or Satellite Box remote

Refer the user manual from your service provider to determine the setting.

If it requires:

- 3 digits, please try “**566**”, “**565**”, “**556**”, or “**688**”. It usually works with DISHNetwork.
- 4 digits, please try “**0054**”. It usually works with Cox.
- 5-digits, please try “**11454**”, “**11054**”, or “**10690**”. It usually works with DIRECTV.

Troubleshooting

Please contact ViewSonic service team directly if you have questions, service needs, or require technical assistance related on the use of your television.

Contact ViewSonic Service Team at:

<http://www.ViewSonic.com>

Or call our service team:

United States 1-800-688-6688

Canada 1-866-463-4775

Problem	Possible Solution
No power	<ul style="list-style-type: none">• Make sure the power cord is properly connected to the LCD TV AC power socket.• Make sure the AC power cord is properly connected to the wall outlet.• Make sure the DC power button is ON (Blue LED).• Plug another electrical device (like a radio) to the power outlet to verify that the outlet is supplying the proper voltage.
No picture	<ul style="list-style-type: none">• The TV station may be experiencing problems. Try another channel.• The Cable TV signal may be scrambled or encoded. Please contact your local cable operator.• Make sure that connection to other components are correct referring to the user guide.• Make sure that setup has been done correctly after connections.• Make sure the correct input is selected and the input signal is compatible.
Strange color, light color, or color misalignment	<ul style="list-style-type: none">• Ensure that the video cable is securely connected.• The picture may appear dim in a brightly lit room.• Adjust brightness, contrast, saturation (color), and tint referring to the user guide.• Check the input signal setting.
No sound	<ul style="list-style-type: none">• Check your audio connections are properly connected referring to the user guide.• The MUTE button may have been pressed, try pressing this button again.• Check your audio settings, your TV audio may be set to minimum.• Press the Volume + (Up) button on the remote control.

Other Information

Problem	Possible Solution
Remote control unit does not operate	<ul style="list-style-type: none">• Make sure the directions of batteries are inserted correctly referring to the user guide.• Batteries could be weak or dead. Replace with new batteries.• Is a fluorescent light illuminated near the remote control sensor?• The path of the remote control beam may be blocked. Make sure the path is clear and that the remote control is aimed at the remote control sensor on the TV.• Press the POWER button on the remote control to see if you can turn on the TV.• Press MENU button on the remote control to see if there is a MENU shown on the screen.• Press only one button at a time and it is the correct one for the operation you want to perform.
Unit cannot be operated	<ul style="list-style-type: none">• External influences such as lightning or static electricity may cause improper operation. In this case, operate the unit after first turning on the power of the LCD TV and the AVC System, or unplug the AC cord for 1 to 2 minutes, then replug again.
Power is cut off suddenly	<ul style="list-style-type: none">• Is the sleep timer set in advance?• Is there no signal in PC mode or HDMI mode?• The internal temperature of the unit has increased. Remove any objects blocking the vent or clean as necessary.
No CATV reception (or no reception above CH13)	<ul style="list-style-type: none">• Is the AIR/CABLE option set correctly? Please set the AIR/CABLE option to CABLE referring to the user guide.• CATV is connected improperly or not connected; please check all the CATV connections.• The cable TV service is interrupted; please contact your cable operator.
Picture is cut off/with sidebar screen	<ul style="list-style-type: none">• Is the image positioned correctly?• Are screen mode adjustments such as picture size set correctly?• Press WIDE button repeatedly on the remote control to see if you can get the picture you prefer.

Contact ViewSonic service team at: <http://www.ViewSonic.com> or call our service team: United States 1-800-688-6688, Canada 1-866-463-4775

Specifications

Model		VT2430
LCD	Type	23.6" TFT Active Matrix RGB 0.2715 (H) x 0.2715 (V) mm pixel
	Color Filter Glass surface	RGB vertical stripe Anti-Glare
Input signal	RGB	RGB analog (0.7/1.0 Vp-p, 75 ohms) Separate Sync, f _h : 30-80 kHz, f _v :50-75 Hz
	RF	TV system Antenna / NTSC+ATSC, TV cable system / CATV+Digital cable
	Video	1 composite RCA, 1 S-Video, 1 YPbPr component, 1 HDMI
	Audio	1 mini-stereo, 2 pair of RCA (L/R) stereo
Compatibility	PC	Up to 1920 x 1080 @ 60 Hz, VGA mode
Resolution	Recommended and supported (VGA mode)	1920 x 1080 @ 60 Hz 1680 x 1050 @ 60 Hz 1440 x 900 @ 60 Hz 1280 x 1024 @ 60 Hz 1280 x 768 @ 60 Hz 1024 x 768 @ 60, 75 Hz 800 x 600 @ 60, 75 Hz 640 x 480 @ 60, 75 Hz
Speaker Output		5W x 2 @ THD=10%
Audio Output		1 Headphone jack
Power	Voltage	100-240 VAC, 50/60 Hz (auto switch)
Display area	Full Scan	521.28mm (H) x 293.22mm (V) 20.5" (H) x 11.5" (V)
Operating conditions	Temperature	32°F to + 104°F (0°C to + 40°C)
	Humidity	10% to 65% (no condensation)
	Altitude	To 10,000 feet (3,000m)
Storage condition	Temperature	-4°F to + 140°F (-20°C to + 60°C)
	Humidity	0% to 90% (no condensation)
	Altitude	To 40,000 feet (12,000m)
Dimensions	Physical	566.7mm x 441.9mm x 211.0mm
	(W) x (H) x (D)	22.3" x 17.4" x 8.3"
Weight	Net	7.0 kg (15.4 lb)
Regulations		UL/cUL, FCC-B (Doc-B), NOM, BETS-7, ENERGY STAR®
Power consumption	On	< 75 W [Max] (blue LED)
	Stand by	< 1 W @ 115 Vac only (orange LED)
Warning: Do not set the graphics card in your computer to exceed these refresh rates; doing so may result in permanent damage to the LCD TV.		

Note: Product Specifications are subject to change without notice.

Limited Warranty

VIEWSONIC® LCD TV

What the warranty covers:

ViewSonic warrants its products to be free from defects in material and workmanship, under normal use, during the warranty period. If a product proves to be defective in material or workmanship during the warranty period, ViewSonic will at its sole option repair or replace the product with a like product. Replacement product or parts may include remanufactured or refurbished parts or components.

How long the warranty is effective:

ViewSonic LCD TV are warranted for one (1) year for all parts excluding the light source and one (1) year for labor from the date of the first customer purchase.

Who the warranty protects:

This warranty is valid only for the first consumer purchaser.

What the warranty does not cover:

1. Any product on which the serial number has been defaced, modified or removed.
2. Damage, deterioration or malfunction resulting from:
 - a. Accident, misuse, neglect, fire, water, lightning, or other acts of nature, unauthorized product modification, or failure to follow instructions supplied with the product.
 - b. Repair or attempted repair by anyone not authorized by ViewSonic.
 - c. Any damage of the product due to shipment.
 - d. Removal or installation of the product.
 - e. Causes external to the product, such as electric power fluctuations or failure.
 - f. Use of supplies or parts not meeting ViewSonic's specifications.
 - g. Normal wear and tear.
 - h. Any other cause which does not relate to a product defect.
3. Any product exhibiting a condition commonly known as "image burn-in" which results when a static image is displayed on the product for an extended period of time.
4. Removal, installation, and set-up service charges.
5. When you mount it on the wall, the following must be noticed:
 - a. The accessories attached with this product are applicable for this product only.
 - b. When the product is mounted on the wall, holes and fixed screws will remain in the wall body.
 - c. Wall face may discolor when this product has been mounted on the wall for a long time.

How to get service:

1. For information about receiving service under warranty, contact ViewSonic Customer Support. You will need to provide your product's serial number.
2. To obtain warranted service, you will be required to provide (a) the original dated sales slip, (b) your name, (c) your address, (d) a description of the problem, and (e) the serial number of the product.
3. Take or ship the product freight prepaid in the original container to an authorized ViewSonic service center or ViewSonic.
4. For additional information or the name of the nearest ViewSonic service center, contact ViewSonic.

Limitation of implied warranties:

There are no warranties, express or implied, which extend beyond the description contained herein including the implied warranty of merchantability and fitness for a particular purpose.

Exclusion of damages:

ViewSonic's liability is limited to the cost of repair or replacement of the product. ViewSonic shall not be liable for:

1. Damage to other property caused by any defects in the product, damages based upon inconvenience, loss of use of the product, loss of time, loss of profits, loss of business opportunity, loss of goodwill, interference with business relationships, or other commercial loss, even if advised of the possibility of such damages.
2. Any other damages, whether incidental, consequential or otherwise.
3. Any claim against the customer by any other party.

Effect of state law:

This warranty gives you specific legal rights, and you may also have other rights which vary from state to state. Some states do not allow limitations on implied warranties and/or do not allow the exclusion of incidental or consequential damages, so the above limitations and exclusions may not apply to you.

Sales outside the U.S.A. and Canada:

For warranty information and service on ViewSonic products sold outside of the U.S.A. and Canada, contact ViewSonic or your local ViewSonic dealer.

The warranty period for this product in mainland China (Hong Kong, Macao and Taiwan Excluded) is subject to the terms and conditions of the Maintenance Guarantee Card.

For users in Europe and Russia, full details of warranty provided can be found in www.viewsoniceurope.com under Support/Warranty Information.

4.3: ViewSonic LCD TV Warranty

LTV_LW01 Rev. 1C 06-25-07

Contact ViewSonic service team at: <http://www.ViewSonic.com> or call our service team: United States 1-800-688-6688, Canada 1-866-463-4775

Mexico Limited Warranty

VIEWSONIC® LCD TV

What the warranty covers:

ViewSonic warrants its products to be free from defects in material and workmanship, under normal use, during the warranty period. If a product proves to be defective in material or workmanship during the warranty period, ViewSonic will, at its sole option, repair or replace the product with a like product. Replacement product or parts may include remanufactured or refurbished parts or components & accessories.

How long the warranty is effective:

ViewSonic LCD TVs are warranted for 1 year for all parts excluding the light source and 1 year for labor from the date of the first customer purchase.

Who the warranty protects:

This warranty is valid only for the first consumer purchaser.

What the warranty does not cover:

1. Any product on which the serial number has been defaced, modified or removed.
2. Damage, deterioration or malfunction resulting from:
 - a. Accident, misuse, neglect, fire, water, lightning, or other acts of nature, unauthorized product modification, unauthorized attempted repair, or failure to follow instructions supplied with the product.
 - b. Any damage of the product due to shipment.
 - c. Causes external to the product, such as electrical power fluctuations or failure.
 - d. Use of supplies or parts not meeting ViewSonic’s specifications.
 - e. Normal wear and tear.
 - f. Any other cause which does not relate to a product defect.
3. Any product exhibiting a condition commonly known as “image burn-in” which results when a static image is displayed on the product for an extended period of time.
4. Removal, installation, insurance, and set-up service charges.

How to get service:

For information about receiving service under warranty, contact ViewSonic Customer Support (Please refer to the attached Customer Support page). You will need to provide your product’s serial number, so please record the product information in the space provided below on your purchase for your future use. Please retain your receipt of proof of purchase to support your warranty claim.

For Your Records

Product Name: _____	Model Number: _____
Document Number: _____	Serial Number: _____
Purchase Date: _____	Extended Warranty Purchase? _____ (Y/N)
	If so, what date does warranty expire? _____

1. To obtain warranty service, you will be required to provide (a) the original dated sales slip, (b) your name, (c) your address, (d) a description of the problem, and (e) the serial number of the product.
2. Take or ship the product in the original container packaging to an authorized ViewSonic service center.
3. Round trip transportation costs for in-warranty products will be paid by ViewSonic.

Limitation of implied warranties:

There are no warranties, express or implied, which extend beyond the description contained herein including the implied warranty of merchantability and fitness for a particular purpose.

Exclusion of damages:

ViewSonic’s liability is limited to the cost of repair or replacement of the product. ViewSonic shall not be liable for:

1. Damage to other property caused by any defects in the product, damages based upon inconvenience, loss of use of the product, loss of time, loss of profits, loss of business opportunity, loss of goodwill, interference with business relationships, or other commercial loss, even if advised of the possibility of such damages.
2. Any other damages, whether incidental, consequential or otherwise.
3. Any claim against the customer by any other party.
4. Repair or attempted repair by anyone not authorized by ViewSonic.



ViewSonic®

Free Manuals Download Website

<http://myh66.com>

<http://usermanuals.us>

<http://www.somanuals.com>

<http://www.4manuals.cc>

<http://www.manual-lib.com>

<http://www.404manual.com>

<http://www.luxmanual.com>

<http://aubethermostatmanual.com>

Golf course search by state

<http://golfingnear.com>

Email search by domain

<http://emailbydomain.com>

Auto manuals search

<http://auto.somanuals.com>

TV manuals search

<http://tv.somanuals.com>