

**Professional Built-In Electric Induction/Radiant
30"/36"W. Glass Ceramic Cooktop****Standard Features & Accessories****All models include**

- Commercial-type styling
- MagneQuick™ induction power generators utilize magnetic energy for superior power, responsiveness, and efficiency
- QuickCook™ surface elements utilize ribbon element technology to reach full power in about 3 seconds
- Strong, wear-resistant glass ceramic top offers excellent cleanability
- Metal knobs with childproof, push-to-turn safety feature

4B model includes

- Four elements (two radiant, two induction)
 - Left front (radiant/dual element)—9" 2,500 watts – 6" 1,000 watts
 - Left rear (radiant)—7" 1,500 watts
 - Right front (induction)—7" 1,800 watts
 - Right rear (induction)—9" 3,300 watts

6B model includes

- Six elements (four radiant, two induction)
 - Left front (radiant/dual element)—9" 2,200 watts – 6" 750 watts
 - Left rear (radiant)—7" 1,500 watts
 - Center front (radiant)—7" 1,800 watts
 - Center rear (radiant)—7" 1,800 watts
 - Bridge (radiant)—800 watts
 - Right front (induction)—7" 1,800 watts
 - Right rear (induction)—9 3,300 watts

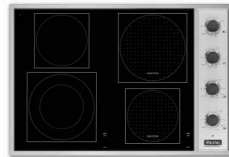
Model Options

VCCU105-4B
30"W. Four-Element
Cooktop

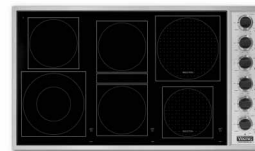

VCCU165-6B
36"W. Six-Element
Cooktop

FINISH DETAILS FOR BOTH MODELS*

- Stainless Steel/Black (SB)
 - Stainless steel trim/frame and control panel.
 - Black glass and knobs.
- Stainless Steel/White (SW)
 - Stainless steel trim/frame and control panel.
 - White glass and knobs.
- Brass Trim Option (BR)—nameplate, control panel frame, and knob bezels. Brass components have a durable protective coating for maintenance-free normal use.

ORDERING INSTRUCTIONS

First specify model number, and then color code (VCCU105-4BSS). If ordering optional brass trim, specify code at end (VCCU105-4BSSBR).





Professional Built-In Electric Induction/Radiant 30"/36"W. Glass Ceramic Cooktop

Dimensions & Specifications

OVERALL PRODUCT DIMENSIONS

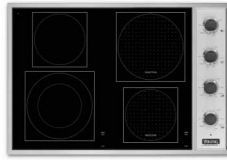

VCCU105-4B
30"W. Four-Element
Cooktop

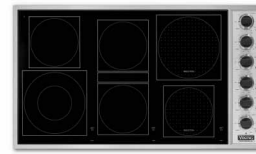

VCCU165-6B
36"W. Six-Element
Cooktop

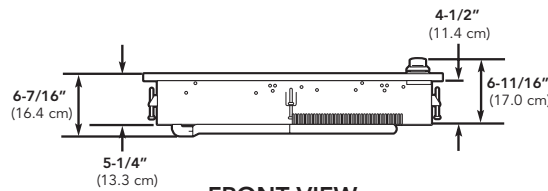
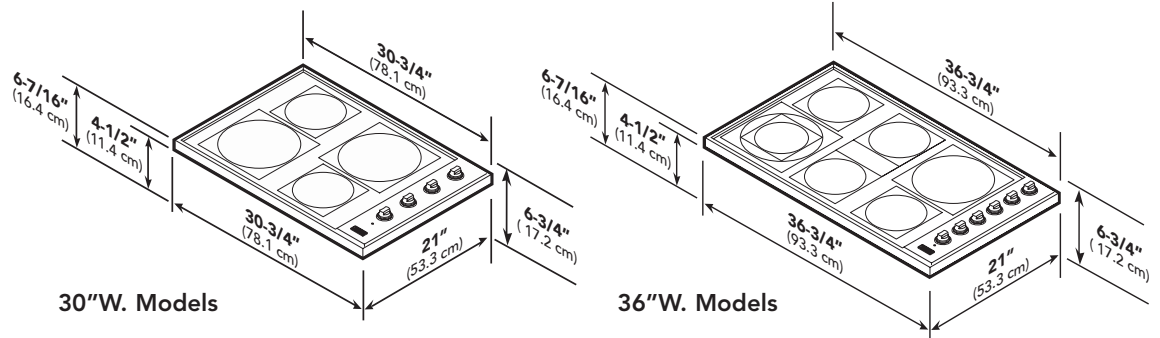

FRONT VIEW

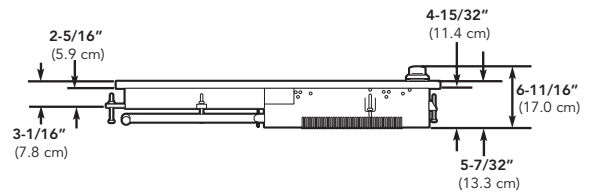

FRONT VIEW

	VCCU105	VCCU165
Overall width	30-3/4" (78.1 cm)	36-3/4" (93.3 cm)
Overall height (from bottom)		6-3/4" (17.2 cm)
To top of knobs		6-11/16" (17.0 cm)
To top of cooking surface		6-7/16" (16.4 cm)
To bottom edge of frame		4-1/2" (11.4 cm)
Overall depth (from rear)		21" (53.3 cm)





Professional Built-In Electric Induction/Radiant 30"/36"W. Glass Ceramic Cooktop

Dimensions & Specifications

CLEARANCE DIMENSIONS

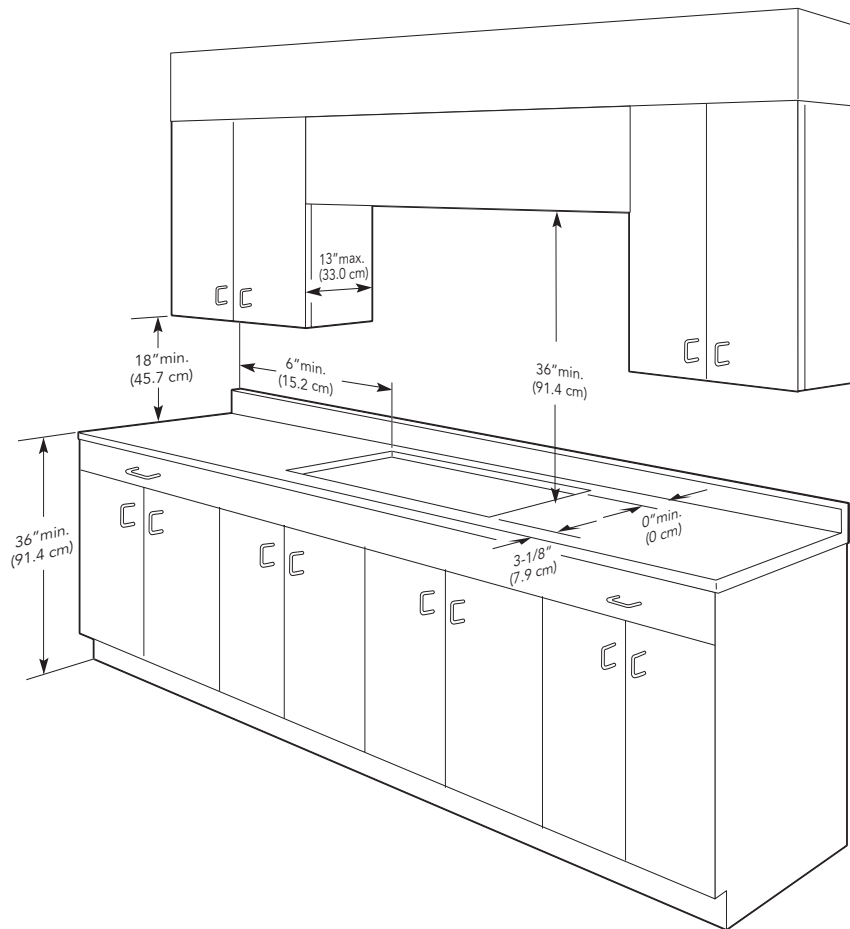

Minimum clearances from adjacent combustible construction

- Above countertop (36" [91.4 cm])
- Sides—6" (15.2 cm)
- Rear—0" (0 cm)
- Within 6" side clearance; wall cabinets no deeper than 13" (33.0 cm)
- Must be minimum 18" (45.7 cm) above countertop
- Wall cabinets directly above cooktop must be minimum 36" (91.4 cm) above the countertop.

1. The cooktop may be installed directly to existing base cabinets.
2. The cooktop **cannot** be installed directly adjacent to sidewalls, tall cabinets, tall appliances, or other side vertical surfaces above 36" (91.4 cm) high. There must be a minimum of 6" (15.2 cm) side clearance from the cooktop to such combustible surfaces above the 36" (91.4 cm) counter height.
3. Within the 6" (15.2 cm) side clearance

to combustible vertical surfaces above 36" (91.4 cm), the maximum wall cabinet depth must be 13" (33.0 cm) and wall cabinets within this 6" (15.2 cm) side clearance must be 18" (45.7 cm) above the 36" (91.4 cm) high countertop.

4. Wall cabinets above the cooktop must be a minimum of 36" (91.4 cm) above the countertop for a full width of the cooktop. This minimum height requirement does not apply if a hood is installed over the cooking surface. The bottom of the hood should be 30" (76.2 cm) min. to 36" (91.4 cm) above the countertop. This would typically result in the bottom of the hood being 66" (167.6 cm) to 72" (182.9 cm) above the floor. Refer to the hood installation instructions for further information.

Warning

The use of cabinets for storage above the appliance may result in a potential burn hazard. If a cabinet storage is to be

provided the risk can be reduced by installing a hood that projects horizontally a minimum of 5" (12.7 cm) beyond the bottom of the cabinets.

Important: The electronic components for the induction elements in the cooktop need some air circulation. To ensure long life of electronic components, **it is required that a minimum of 8" (20.3 cm) open space remain between the bottom of the cooktop and any shelf underneath.** The maximum length of the shelf underneath is 18" (45.7 cm). There should be no partition or shelf **directly** underneath the unit. It is also required that the exit air ports at the rear are not blocked. There should be a minimum of 1-1/4" (3.2 cm) space between the exit air ports at the rear of the unit and any nearby obstruction, including downdrafts.



Professional Built-In Electric Induction/Radiant 30"/36"W. Glass Ceramic Cooktop

UTILITY REQUIREMENTS



GAS

- Not applicable



ELECTRICAL

- 4-foot (121.9 cm) flexible conduit included*
- 3-wire conduit with a No. 10 ground wire
- 240 – 208/120 V/60 Hz
- Maximum amp usage—(240V/208V)
 - o 4B—37.9/35.4
 - o 6B—55.0/50.2
- Do not use an extension cord with this appliance.



PLUMBING

Not applicable

Installation Requirements

ACCESS REQUIREMENTS

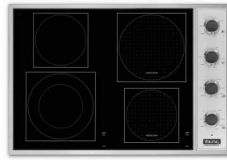

VCCU105-4B
30"W. Four-Element Cooktop

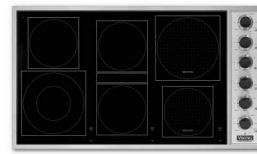

VCCU165-6B
36"W. Six-Element Cooktop

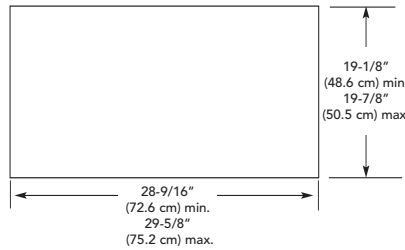

30"W. Cutout

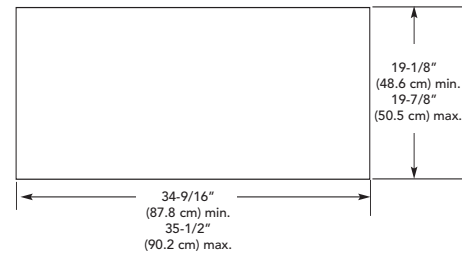

36"W. Cutout

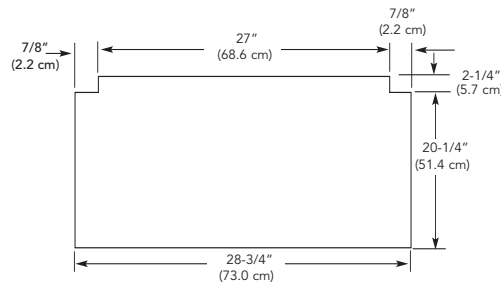

30"W. Cutout w/Downdraft

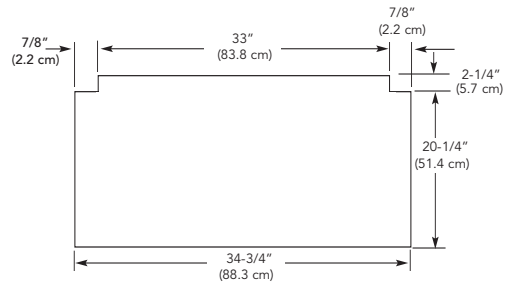

36"W. Cutout w/Downdraft

Note: Before cutting countertop cutout, check the inside clearance available from the inside back wall to the proposed placement of the cooktop. A minimum of 1-1/4" (3.2 cm) is required from the back wall of the cooktop to the **inside** wall of the back cabinet. This may require a distance greater than the 0" minimum approved distance.

	VCCU105-4B		VCCU165-6B	
Cutout width	28-9/16" (72.9 cm) min. – 29-5/8" (75.2 cm) max.		34-9/16" (87.8 cm) min. – 35-1/2" (90.2 cm) max.	
Cutout depth	19-1/8" (48.6 cm) min. to 19-7/8" (50.5 cm) max.			
Surface burner rating	240V	208V	240V	208V
Right front	1,800 watts	1,560 watts	1,800 watts	1,560 watts
Right rear	3,300 watts	2,800watts	3,300 watts	2,800watts
Left front (dual element)	2,500/ 1,000 watts	1,875/ 750 watts	2,500/ 750 watts	1,650/ 562 watts
Left rear	1,500 watts	1,125 watts	1,500 watts	1,125 watts
Center front	N/A		1,800 watts	1,350 watts
Center rear	N/A		1,800 watts	1,350 watts
Bridge	N/A		800 watts	600 watts





COOKING

Professional Built-In Electric Induction/Radiant 30"/36"W. Glass Ceramic Cooktop



Compliance Information



WARRANTY INFORMATION*

- One-year full warranty—complete product
- Five-year limited warranty—surface burners and electric elements
- Ninety-day limited warranty—cosmetic parts such as glass, painted, and decorative items

* For complete warranty see *Use & Care Guide*. Warranty valid on Viking products shipped within the United States and Canada.



Free Manuals Download Website

<http://myh66.com>

<http://usermanuals.us>

<http://www.somanuals.com>

<http://www.4manuals.cc>

<http://www.manual-lib.com>

<http://www.404manual.com>

<http://www.luxmanual.com>

<http://aubethermostatmanual.com>

Golf course search by state

<http://golfingnear.com>

Email search by domain

<http://emailbydomain.com>

Auto manuals search

<http://auto.somanuals.com>

TV manuals search

<http://tv.somanuals.com>