



***WINEMATE Split System***  
***Installation, Operation & Care Manual***

**WM1500 SSW**  
**WM2500 SSW**



***Vinotemp International Corp.***

**[www.vinotemp.com](http://www.vinotemp.com)**

**READ AND SAVE THESE INSTRUCTIONS**

**TABLE OF CONTENTS**

**Important Safety Information.....2**

**Feature Description.....3**

**Installation Instruction.....5**

**Use and Temperature Control.....7**

**Care Guide.....10**

**Troubleshooting.....11**

**Customer Support.....13**

**Warranty.....14**

## Important Safety Information

### **WARNING**



#### To avoid the risk of electrical shock, property damage, personal injury or death:

- The power cord must be plugged into a 3-prong grounding-type wall receptacle, grounded in accordance with the National Electrical Code, ANSI/NFPA 70 - latest edition and local codes and ordinances.
- It is the personal responsibility of the consumer to have a proper 3-prong wall receptacle installed by a qualified electrician.
- **DO NOT, UNDER ANY CIRCUMSTANCES, REMOVE THE POWER CORD GROUNDING PRONG.**
- A separate adequately fused and grounded circuit should be available for this appliance.
- Do not remove any grounding wires from individual components while servicing, unless the component is to be removed and replaced. *It is extremely important to replace all grounding wires when components are replaced.*

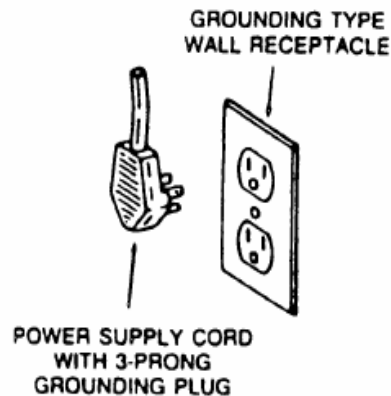

### **WARNING**



#### **ELECTRIC SHOCK HAZARD**

- Disconnect electric supply from appliance before servicing.
- Replace all panels before operating.
- Failure to do so could result in death or electrical shock.

- **DO NOT USE A GROUND FAULT INTERRUPTER (GFI).**
- **A DEDICATED 20 AMP CIRCUIT IS HIGHLY RECOMMENDED.**

## Feature Description

- WineMate split cooling system is designed and used to provide a stable temperature between 52~62 °F for suitable space at a normal environment.
- The refrigerated space will maintain humidity of 50~70% RH even when the environment becomes dry and humid.
- These temperatures and humidities are optimized for long term storage of wine, fur and tobacco.
- SSW units are designed for installation between two wall studs, making them an ideal choice for small and medium wine rooms.
- The condensing unit is located away from the wine cellar or other refrigerated enclosure as far as 50 feet, which will bring you extremely quiet operation.

The dimension and capacity are specified as follows:

<b>Model</b>	<b>Capacity (Btu/h) 55/90 °F</b>	<b>Unit Cooler</b>	<b>Cond Unit</b>	<b>Electrical Unit Cooler/Cond Unit</b>	<b>Refrigerant</b>	<b>Weight (lb) Unit Cooler/Cond Unit</b>
WM1500 SSW	1500	WM15 SFCW	WM15 SCU	115V 60HZ 0.71A/ 115V 60HZ 3.2A	R134a	26/30
WM2500 SSW	2500	WM25 SFCW	WM25 SCU	115V 60HZ 0.71A/ 115V 60HZ 5.7A	R134a	28/40

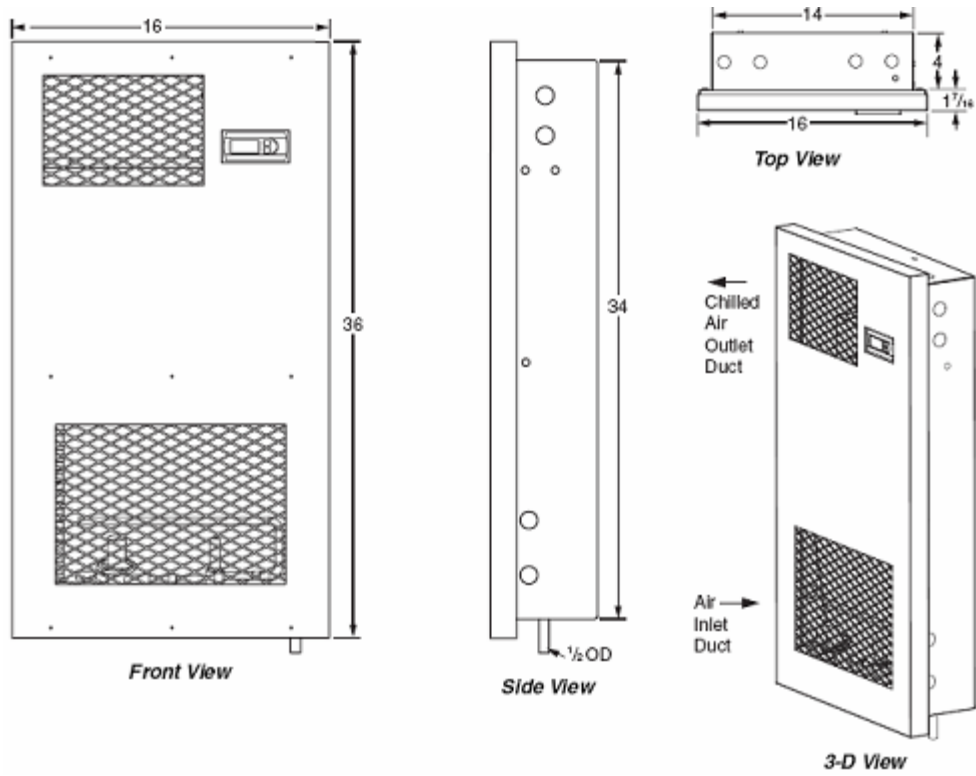

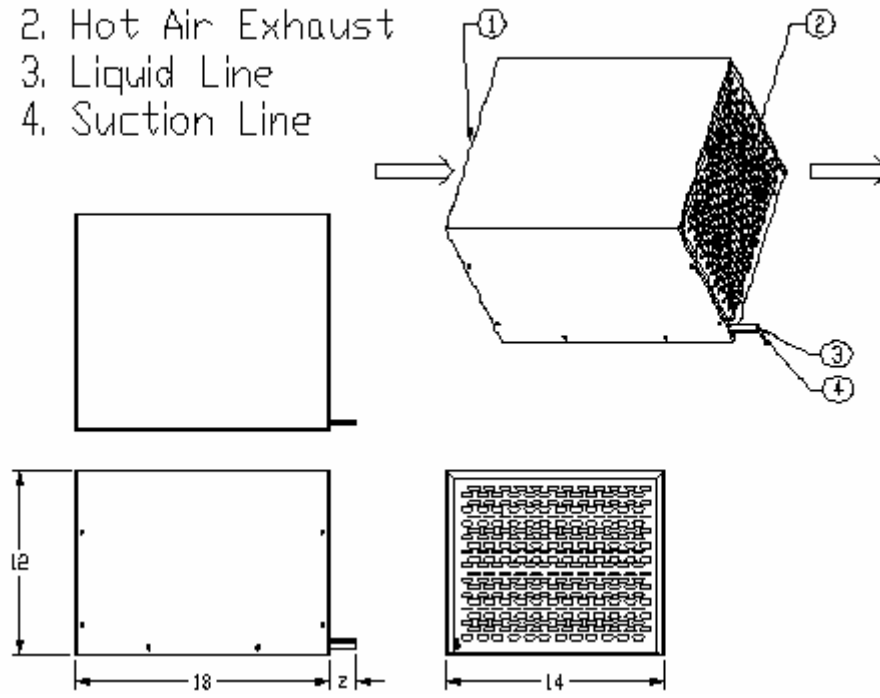

**Evaporator Unit**

1. Fresh Air Intake
2. Hot Air Exhaust
3. Liquid Line
4. Suction Line



**Condensing Unit**

# Installation Instruction

 <b>WARNING</b>	
	<p>Always check wiring harness connections before initiating any test procedures.</p> <p>Disconnect electric power from the appliance before performing any maintenance or repairs.</p> <p>Voltage checks should be made by inserting meter probes beside the wires in the connector blocks with the electric power source on and the connector block plugged in.</p> <p>Resistance checks should be made on components with the electric power off and the connector block disconnected.</p>

**Federal law requires that WINEMATE split cooling systems be installed by an EPA certified refrigeration technician.**

## 1. Location

- Place the condensing unit in a properly ventilated location. If it is not, heat exhausted by the condensing unit will build up and the cooling system will not operate properly.
- Leave minimum 3 feet clearance between the exhaust side and the wall.
- Leave minimum 1 foot clearance for the fresh air supply side.
- Condensing unit should be elevated to avoid possible flooding and shaded from direct sun. It should not be exposed to temperatures higher than 125 °F or lower than 20 °F.
- Air flow from the unit cooler should be unobstructed for at least 1 foot.

## 2. Refrigeration Installation

Model	Liquid Line Diameter (inch), recommended	Suction Line Diameter (inch), recommended
WM-1500SSW	3/8	3/8
WM-2500SSW	3/8	3/8

WINEMATE split system is shipped as components and is ready for use only after a certified refrigeration technician has properly installed and tested the system. Proper installation is critical. WINEMATE can only warrant the quality of the components. The installation and proper operation of the system must be warranted by the installer.

Installation of the system must be done in accordance with all state and local building codes.

The condensing unit and unit cooler are connected by a liquid line and an insulated suction line that are supplied by the installer. These lines must be properly sized for the distance between the two units. After the units and the lines are installed, the system must be pressure tested. If no leaks are found, evacuate and charge system with R134A. Refrigerant amount will vary depending on the length of line set.

### 3. Electrical Wiring

- We strongly recommend against the use of an extension cord. However, if you still select to use an extension cord, it is absolutely necessary that it is a UL LISTED 3-wire grounding type appliance extension cord. The marked rating of the extension cord should be 115 V, 20 A. or equivalent and not greater than 15ft in length.

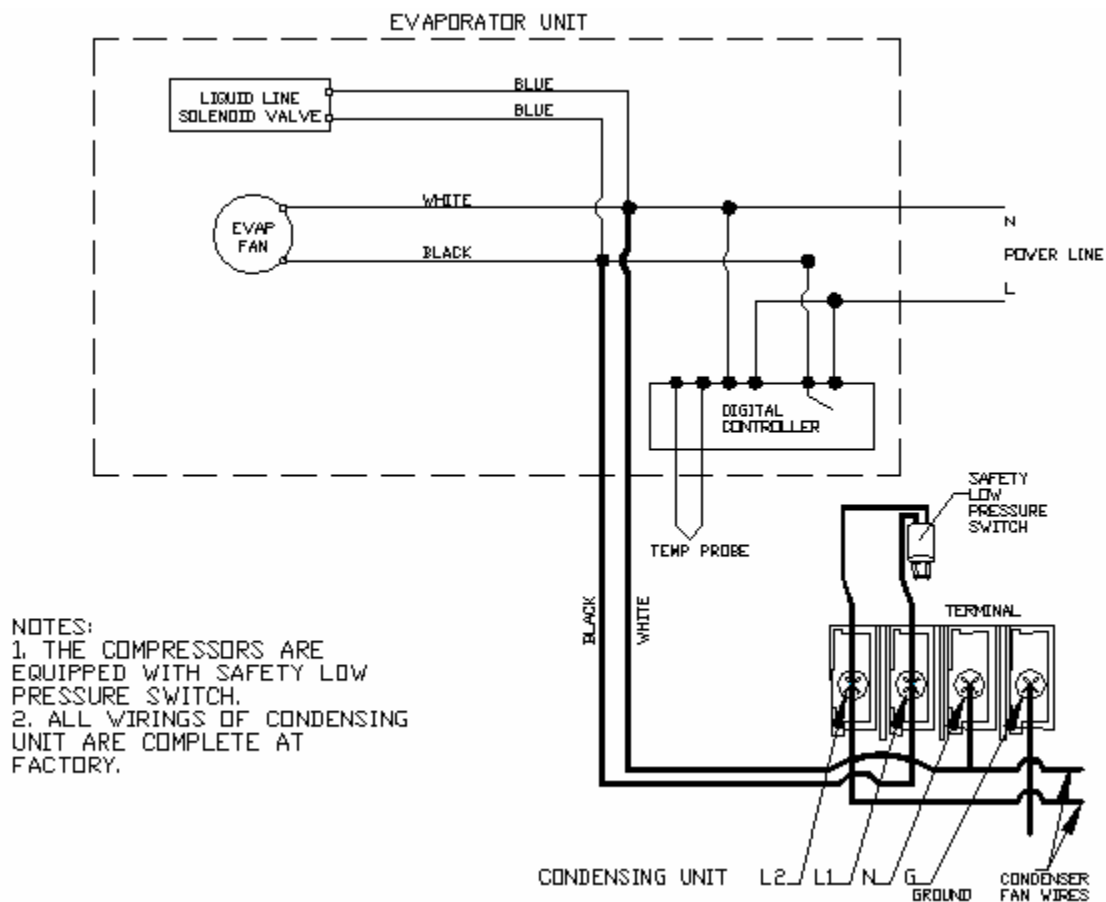

**1500 & 2500SSW Electrical Wiring Diagram**

# Use & Temperature Control

## 1. Temperature Setting

- Set the temperature at 55 °F for the optimum aging of wine
- Set the temperature higher at very high ambient temperature.
- On initial start-up, the time required to reach the desired temperature will vary, depending on the quantity of bottles, temperature setting and surrounding temperature.
- Allow 24 hours to stabilize the temperature for each new temperature setting operation

## 2. Use of the controller



### 1) Display

During normal operating conditions, the display shows the value measured by the air regulation probe. In case of active alarm, the temperature flashes alternately to the code alarm.

#### 1.1 LED Functions

LED	MODE	FUNCTION
❄️	ON	Compressor enabled
❄️	Flashing	Anti-short cycle delay enabled
❄️	ON	Defrost enabled
🔊	ON	An alarm is occurring
°C/°F	ON	Measurement unit
°C/°F	Flashing	Programming phase



## 1.2 Front Panel Commands

**SET**: To display target set point; in programming mode it selects a parameter or confirm an operation.



 **(DEF)** To start a manual defrost

 **(UP)**: To see the max. stored temperature; in programming mode it browses the parameter codes or increases the displayed value.

 **(DOWN)** To see the min stored temperature; in programming mode it browses the parameter codes or decreases the displayed value.

**O/I** To turn ON or OFF the controller (if enabled)

### KEY COMBINATIONS:

 +  To lock & unlock the keyboard.

**SET** +  To enter in programming mode.

**SET** +  To return to the room temperature display.

## 2) Alarm Signals

### 2.1 Code Description

Message	Cause	Outputs
"P1"	Room probe failure	Compressor output acc. to par. "Con" and "COF"
"HA"	Maximum temperature alarm	Outputs unchanged.
"LA"	Minimum temperature alarm	Outputs unchanged.
"CA"	Serious external alarm (i1F=bAL)	All outputs OFF.

### 2.2 Alarm Recovery

Probe alarms "P1", start a few seconds after the fault in the related probe; they automatically stop a few seconds after the probe restarts normal operation. Check connections before replacing the probe. Temperature alarms "HA", "LA" automatically stop as soon as the temperature returns to normal value. Alarm "CA" (with i1F=PAL) recovers only by switching off and on the instrument.

## 3) Set-Point (desired temperature value)

### 3.1 How to see the set-point

1. Push and immediately release the SET key: the display will show the Set-point value;
2. Push and immediately release the SET key or wait for 5 seconds to display the probe value again.



### 3.2 How to change the set-point

1. Push the SET key for more than 3 seconds to change the Set point value;
2. The value of the set point will be displayed and the “°C” or “°F” LED starts blinking;
3. To change the Set value, push the o or n arrows within 10s.
4. To memorize the new set point value, push the SET key again or wait 10s.

#### **4) Manual Defrost**

Push the DEF key for more than 2 seconds and a manual defrost will start.

## Care Guide

 <b>WARNING</b>	
	<b>ELECTRIC SHOCK HAZARD</b> Disconnect the electrical power before servicing any components. Failure to do so can result in death or electrical shock.

In general, always unplug system or disconnect power while doing care.

### 1. Coil Cleaning

- Clean the condenser coil regularly. Coil may need to be cleaned at least every 6 months.
- Unplug the system or disconnect power.
- Use a vacuum cleaner with an extended attachment to clean the coil when it is dusty or dirty.
- Plug cooling system or reconnect power.

### 2. Moisture Removing

- Remove the extra condensate if it is accumulated in the wine cellar at high ambient temperature and humidity.

# Troubleshooting

This Troubleshooting Chart is not prepared to replace the training required for a professional refrigeration service person, not is it comprehensive

## Troubleshooting Chart

Complaint	Possible Causes	Response
<b>1. Unit not running</b>		
	<ul style="list-style-type: none"> <li>a. Power cord unplugged</li> <li>b. No power to unit</li> <li>c. Temperature setting high</li> <li>d. Low voltage.</li> <li>e. Incorrect or loose wirings.</li> <li>f. Defrost light blinking</li> <li>g. Running light blinking</li> </ul>	<ul style="list-style-type: none"> <li>a. Check for power cord plug</li> <li>b. Check power at receptacle &amp; fuses</li> <li>c. Lower temperature setting</li> <li>d. Contact an authorized electrician</li> <li>e. Check all wirings and connections</li> <li>f. Under defrost</li> <li>g. Call service for failed components</li> </ul>
<b>2. Compressor stopping and starting but short running time</b>		
	<ul style="list-style-type: none"> <li>a. Incorrect temperature setting</li> <li>b. Incorrect voltage</li> <li>c. Failed thermistor</li>   <li>d. Failed components</li>   <li>e. Improper condenser airflow</li> <li>f. Dirty condenser</li> <li>g. Overcharge of refrigerant</li> <li>h. Discharge or suction pressure too high</li> </ul>	<ul style="list-style-type: none"> <li>a. Set 55 to 60 °F</li> <li>b. Check for voltage</li> <li>c. Check thermistor by placing it in ice water and measuring resistance</li> <li>d. Check compressor windings, start relay and overload protector.</li> <li>e. Check for condenser fan</li> <li>f. Clean condenser</li> <li>g. Call service for removing refrigerant</li> <li>h. Call service for OEM information</li> </ul>
<b>3. Fan motor running but compressor not running</b>		
	<ul style="list-style-type: none"> <li>a. Incorrect power supply</li> <li>b. Incorrect or loose wirings</li> <li>c. Failed components</li>   <li>d. Liquid refrigerant in the compressor</li> </ul>	<ul style="list-style-type: none"> <li>a. Check for proper voltage</li> <li>b. Check all wirings and connections</li> <li>c. Check start relay, start capacitor, overload protector, compressor.</li> <li>d. Call service for OEM information.</li> </ul>
<b>4. Compressor running but fan not running</b>		
	<ul style="list-style-type: none"> <li>a. Fan blade bond</li> <li>b. Incorrect or loose wirings</li> <li>c. Failed motors</li> </ul>	<ul style="list-style-type: none"> <li>a. Check for proper clearance</li> <li>b. Check all wirings</li> <li>c. Call service for checking open or shorted windings</li> </ul>
<b>5. No cooling but compressor and fan running</b>		
	<ul style="list-style-type: none"> <li>a. Evaporator airflow restriction</li> <li>b. Refrigerant leakage</li> <li>c. Refrigeration system restriction</li> </ul>	<ul style="list-style-type: none"> <li>a. Check for airflow through evaporator</li> <li>b. Check for loss of refrigerant</li> <li>c. Call service for checking restrictions</li> </ul>
<b>6. Temperature too high or unit running too long</b>		
	<ul style="list-style-type: none"> <li>a. Improper evaporator or condenser airflow</li> <li>b. Dirty Condenser</li> <li>c. Iced evaporator</li> <li>d. Malfunctioning fans</li> <li>e. Improper seals</li> <li>f. Improper area to be cooled.</li> </ul>	<ul style="list-style-type: none"> <li>a. Check for air restrictions</li>   <li>b. Clean condenser</li> <li>c. Defrost and reset temperature</li> <li>d. Check for both fans</li> <li>e. Check for gasket and door opening</li> <li>f. Check for excessive load incorrect installation</li> </ul>

	<ul style="list-style-type: none"> <li>g. Low voltage</li> <li>h. Operating 60 Hz unit at 50Hz</li> <li>i. Sealed system problem</li> <li>j. Undercharge or overcharge</li> </ul>	<ul style="list-style-type: none"> <li>g. Check power supply</li> <li>h. Use proper 60 Hz</li> <li>i. Call service for checking loss of refrigerant or restrictions</li> <li>j. Call service to add or remove refrigerant</li> </ul>
<b>7. House circuit tripping</b>		
	<ul style="list-style-type: none"> <li>a. Incorrect fuse or breaker</li> <li>b. Incorrect wirings</li> <li>c. Failed components</li> </ul>	<ul style="list-style-type: none"> <li>a. Check for proper fuse or breaker</li> <li>b. Check for wirings and connections</li> <li>c. Call service</li> </ul>
<b>8. Noisy operation</b>		
	<ul style="list-style-type: none"> <li>a. Mounting area not firm</li> <li>b. Loose parts</li> <li>c. Compressor overloaded due to high ambient temperatures or airflow restriction</li> <li>d. Malfunctioning components</li> </ul>	<ul style="list-style-type: none"> <li>a. Add support to improve installation</li> <li>b. Check fan blades, bearings, cabinet washers, tubing contact and loose screws.</li> <li>c. Check for airflow blockage</li> <li>d. Call service for checking Internal loose, inadequate lubrication and incorrect wirings</li> </ul>

## Customer Support

If you still have problems, please contact us at:

Vinotemp International  
17631 South Susana Road  
Rancho Dominguez, CA 90221  
Tel: (310) 886-3332  
Fax: (310) 886-3310  
Email: [info@vinotemp.com](mailto:info@vinotemp.com)

# Warranty

**Thank you for choosing a Vinotemp wine cellar.**

Please enter the complete model and serial numbers in the space provided:

Model \_\_\_\_\_  
Serial No. \_\_\_\_\_

Attach your purchase receipt to this owner's manual.

## 1. Limited Warranty

VINOTEMP warrants its products, parts only, to be free from defects due to workmanship or materials under normal use and service for twelve months after the initial sale. If the product is defective due to workmanship or materials, is removed within twelve months of the initial sale and is returned to VINOTEMP, in the original shipping carton, shipping prepaid, VINOTEMP will at its option, repair or replace the product free of charge.

This warranty constitutes the entire warranty of the VINOTEMP with respect to its products and is in lieu of all other warranties, express or implied, including any of fitness for a particular purpose. In no event shall VINOTEMP be responsible for any consequential damages what is so ever. Any modification of VINOTEMP products shall void this warranty.

## Service under Warranty

This service is provided to customers within the continental UNITED STATES only. VINOTEMP cooling units are warranted to produce the stated number of BTU/H. While every effort has been made to provide accurate guidelines, VINOTEMP can not warranty its units to cool a particular enclosure.

In case of failure, VINOTEMP cooling units must be repaired by the factory or its authorized agent. Repairs or modifications made by anyone else will void the warranty.

Should a VINOTEMP cooling unit fail, contact the dealer for instructions. Do not return the unit to the factory without authorization from VINOTEMP. If the unit requires repair, re-pack it in the original shipping carton and return it to the factory, shipping prepaid. VINOTEMP will not accept COD shipments. If the unit is determined to be faulty and is within the twelve month warranty period

VINOTEMP will, at its discretion, repair or replace the unit and return it free of charge to the original retail customer. If the unit is found to be in good working order, or beyond the initial twelve month period, it will be returned freight collect.

## **2. Limitation of Implied Warranty**

**VINOTEMP'S SOLE LIABILITY FOR ANY DEFECTIVE PRODUCT IS LIMITED TO, AT OUR OPTION, REPAIRING OR REPLACING OF UNIT.**

**VINOTEMP SHALL NOT BE LIABLE FOR:  
DAMAGE TO OTHER PROPERTY CAUSED BY ANY DEFECTS IN THE UNIT,  
DAMAGES BASED UPON INCONVENIENCE, LOSS OF USE OF THE UNIT,  
LOSS OF TIME OR COMMERCIAL LOSS, ANY OUTER DAMAGES,  
WHETHER INCIDENTAL, CONSEQUENTIAL OR OTHERWISE.**

**THIS WARRANTY IS EXCLUSIBE AND IS IN LIEU OF ALL OTHER WARRANTIES, EXPRESSED OR INPLIED, INCLUDING BUT NOT LIMITED TO, IMPLIED WARRANTIES OF MERCHANTABILITY OR FITNESS FOR A PARTICULAR PURPOSE.**

While great effort has been made to provide accurate guidelines VINOTEMP cannot warrant its units to properly cool a particular enclosure. Customers are cautioned that enclosure construction, unit location and many other factors can affect the operation and performance of the unit. There for suitability of the unit for a specific enclosure or application must be determined by the customer and cannot be warranted by VINOTEMP.



## Free Manuals Download Website

<http://myh66.com>

<http://usermanuals.us>

<http://www.somanuals.com>

<http://www.4manuals.cc>

<http://www.manual-lib.com>

<http://www.404manual.com>

<http://www.luxmanual.com>

<http://aubethermostatmanual.com>

Golf course search by state

<http://golfingnear.com>

Email search by domain

<http://emailbydomain.com>

Auto manuals search

<http://auto.somanuals.com>

TV manuals search

<http://tv.somanuals.com>