



Assembly & Owner's Guide



ST750
LEG EXTENSION/CURL

Table of Contents

ASSEMBLY GUIDE

ASSEMBLY GUIDE	4
HARDWARE BAGS	6
STEP 1: ORANGE BAG	10
STEP 2: BLUE BAG	11
STEP 3: PINK BAG	12
STEP 4: GREEN BAG	13
STEP 5: BLACK BAG	14
STEP 6: YELLOW BAG	15
STEP 7: RED BAG	16
STEP 8: LIGHT BLUE BAG	17

OWNER'S GUIDE

RESISTANCE TRAINING BENEFITS & TIPS, WORKOUT VARIATIONS	18
TRAINING PROGRAMS	19
STRETCHING	20
MAINTENANCE SCHEDULE	22
COMMERCIAL WARRANTY	23
WORKOUT LOGS	24

Assembly & Owner's Guide

ST750 **LEG EXTENSION/CURL**

To avoid possible damage to this Leg Extension/Curl, please follow these assembly steps in the correct order. Before proceeding, find your new Leg Extension/Curl serial number located on the back of the rear floor support (AG2), and enter here:

Refer to this number when calling for service, and enter this serial number on your Warranty Card and in your own records. Be sure to read your Owner's Guide before using your new Leg Extension/Curl.
If any parts, hardware or tools are missing, please call 1.800.335.4348, Extension 12

NOTE: During assembly, it is recommended to ensure that all bolts are in place and partially threaded before completely tightening any one bolt. During assembly steps 1 thru 4, do not completely tighten any bolts until completion of Step 4.

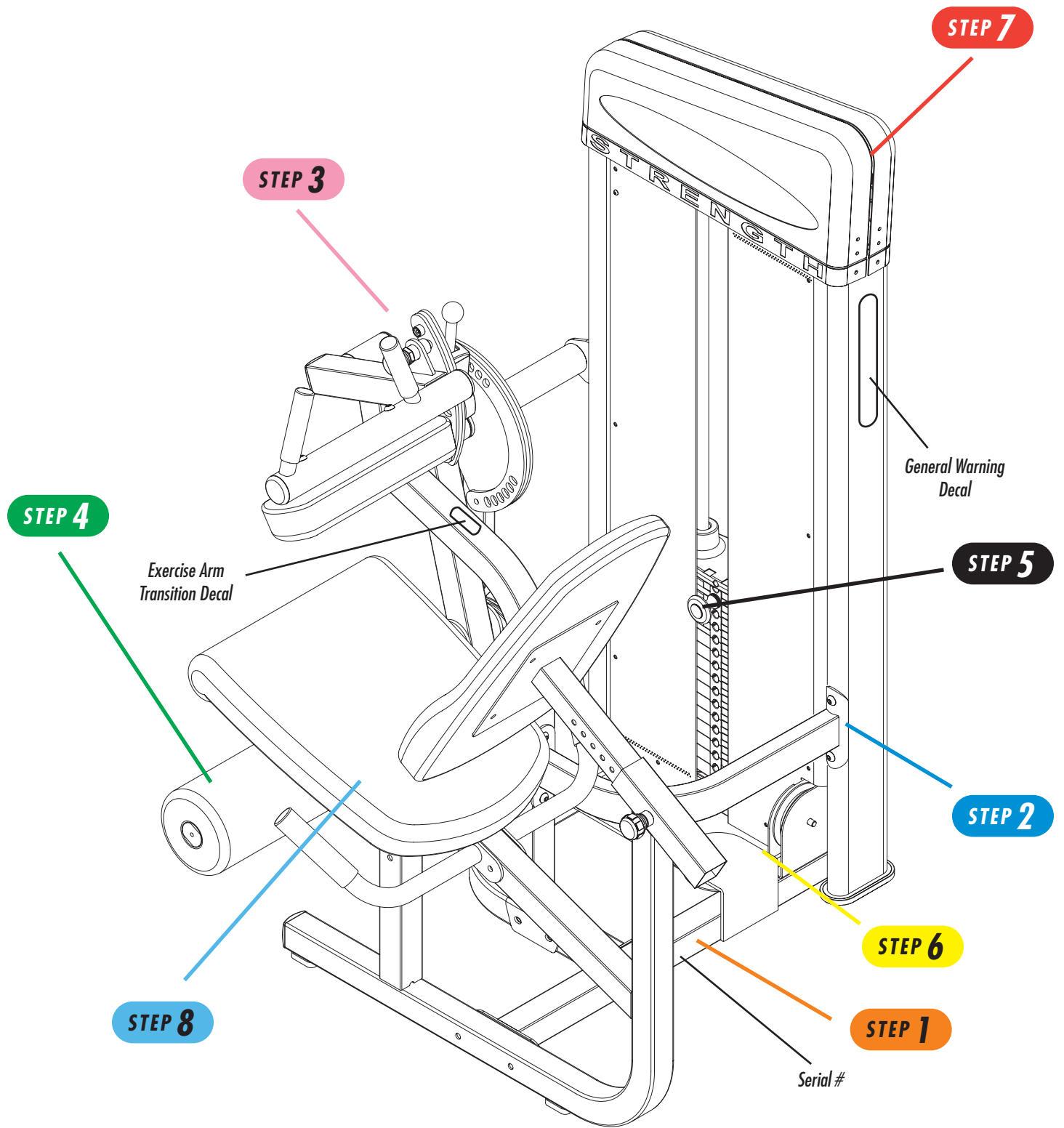

HARDWARE INCLUDED

ORANGE BAG

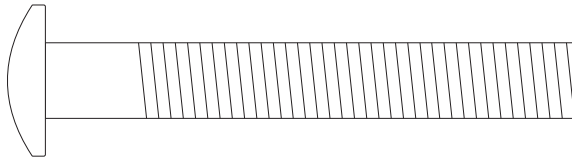
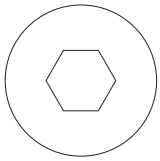

M10 x 70 Bolt
Quantity: 4

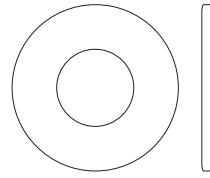

10.2 x 22 x 2
Flat Washer
Quantity: 8

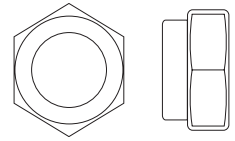

M10 Nylon Nut
Quantity: 4

BLUE BAG

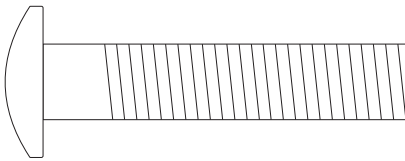
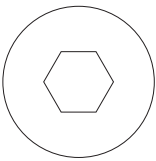

M10 x 48 Bolt
Quantity: 2

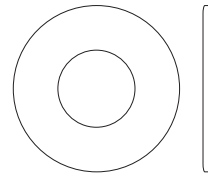

10.2 x 22 x 2
Flat Washer
Quantity: 16

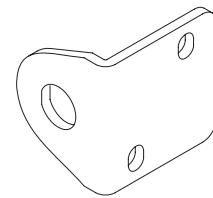

Bracket (Z27)
(illustration not to scale)
Quantity: 1

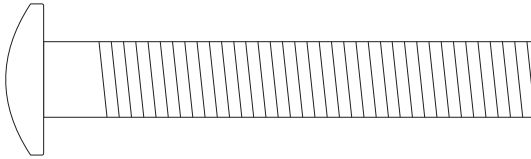
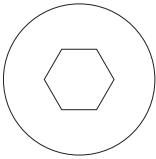

M10 x 65 Bolt
Quantity: 2

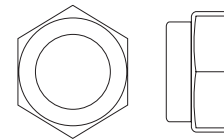

M10 Nylon Nut
Quantity: 8

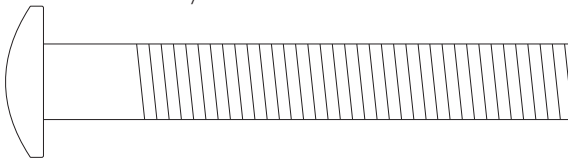
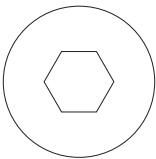

M10 x 70 Bolt
Quantity: 4

HARDWARE INCLUDED

PINK BAG

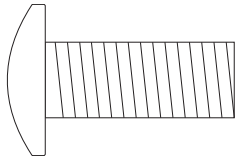
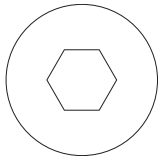

M10 x 25 Bolt
Quantity: 1

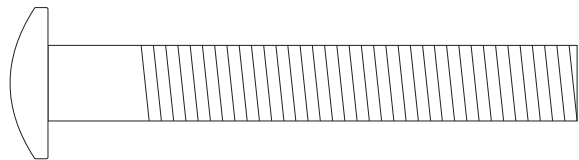
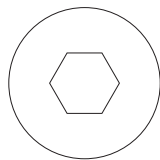

M10 x 70 Bolt
Quantity: 4

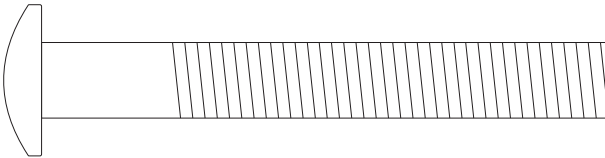
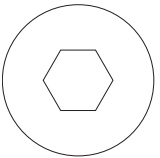

M10 x 75 Bolt
Quantity: 4

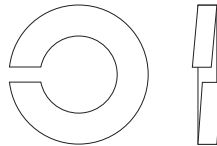

10.2 x 18.4 x 2.5
Lock Washer
Quantity: 1

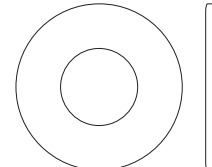

10.2 x 22 x 2
Flat Washer
Quantity: 17

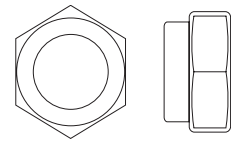

M10 Nylon Nut
Quantity: 8

GREEN BAG

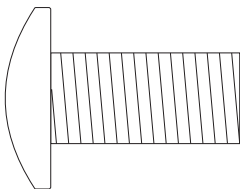
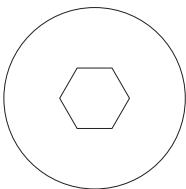

M12 x 25 Bolt
Quantity: 4

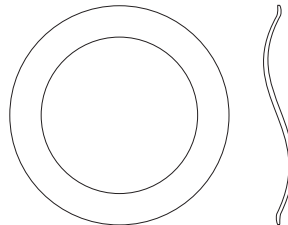

20.7 x 29 x 0.3
Wavy Washer
Quantity: 1

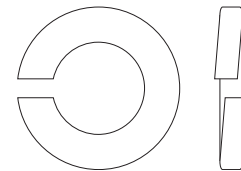

12.2 x 21.5 x 3
Lock Washer
Quantity: 4

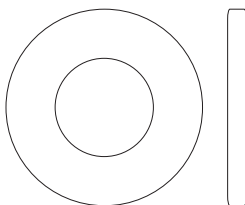

13 x 26 x 2.5
Flat Washer
Quantity: 2

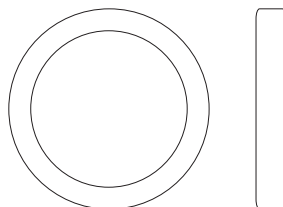

20.7 x 26.5 x 4
Spacer
Quantity: 1

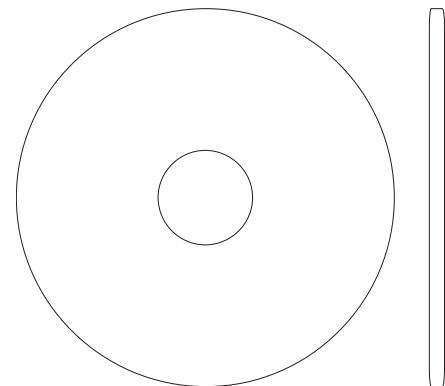

12.5 x 50 x 2
Flat Washer
Quantity: 2

HARDWARE INCLUDED

BLACK BAG

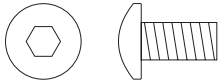

M5 x 10 Bolt
Quantity: 20

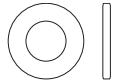

5.3 x 10 x 1
Flat Washer
Quantity: 20

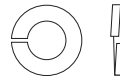

5.1 x 9.3 x 1.3
Lock Washer
Quantity: 20

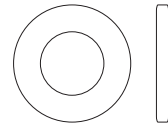

8.4 x 15.5 x 1.6
Flat Washer
Quantity: 4

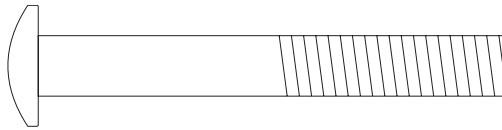
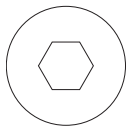

M8 x 62 Bolt
Quantity: 2

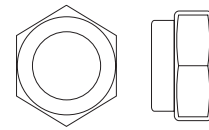

M8 Nylon Nut
Quantity: 2

YELLOW BAG

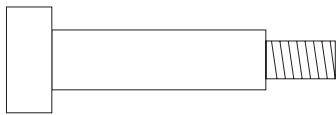
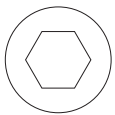

M8 x 37.5 Bolt
Quantity: 1

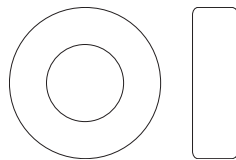

10.2 x 20 x 6
Spacer
Quantity: 2

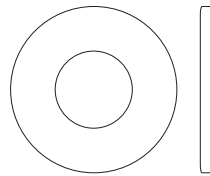

10.2 x 22 x 2
Flat Washer
Quantity: 2

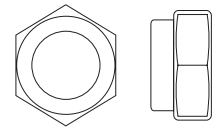

M8 Nylon Nut
Quantity: 1

RED BAG



M5 x 10 Bolt
Quantity: 18



M5 x 15 Bolt
Quantity: 6



Slip-On Nut
illustration not to scale
Quantity: 2

HARDWARE INCLUDED

LIGHT BLUE BAG

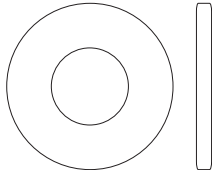

10.2 x 22 x 2
Flat Washer
Quantity: 12

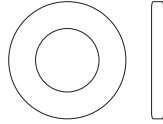

8.4 x 15.5 x 1.6
Flat Washer
Quantity: 1

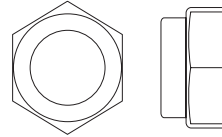

M10 Nylon Nut
Quantity: 6

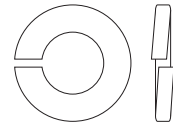

8.2 x 15.4 x 2
Lock Washer
Quantity: 1

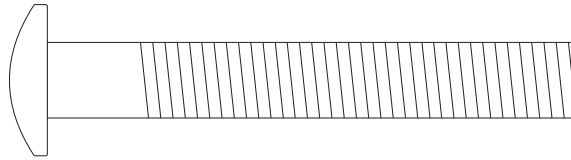
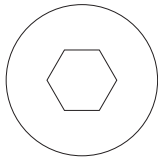

M10 x 70 Bolt
Quantity: 4

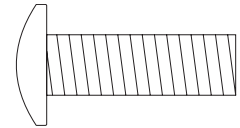
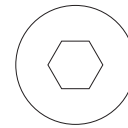

M8 x 25 Bolt
Quantity: 1

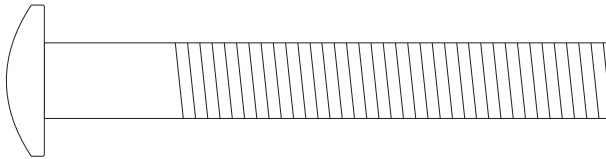
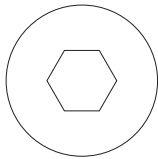

M10 x 75 Bolt
Quantity: 2

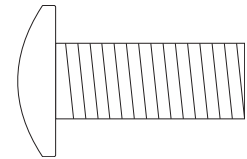
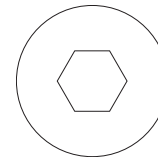

M10 x 25 Bolt
Quantity: 8

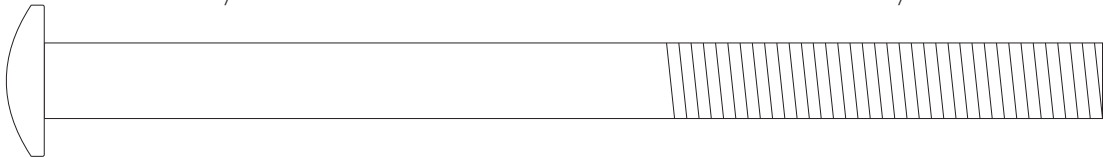
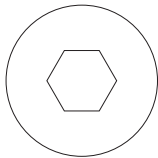

M10 x 140 Bolt
Quantity: 2

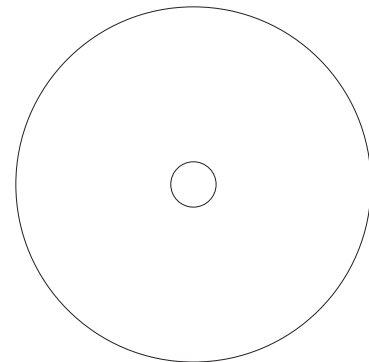

Disc (D41)
(illustration not to scale)
Quantity: 1

STEP 1**ORANGE BAG**

NOTE: During assembly, it is recommended to ensure that all bolts are in place and partially threaded before completely tightening any one bolt. During assembly steps 1 thru 4, do not completely tighten any bolts until completion of Step 4.

- Lay the rear floor support (AG2) flat on the ground, with pulley brackets on the top. Stand up seat support frame (AC1) and align holes along bottom of seat frame with end of rear floor support. Attach using two bolts (M10x70), four flat washers (10.2x22x2), and two nylon nuts (M10).

- Place the T-shaped end of the center floor support (AG3) up against the holes in the middle of the rear floor support. Make sure L-shaped end is facing away from seat support frame. Secure connection using two bolts (M10x70), four flat washers (10.2x22x2), two nylon nuts (M10).

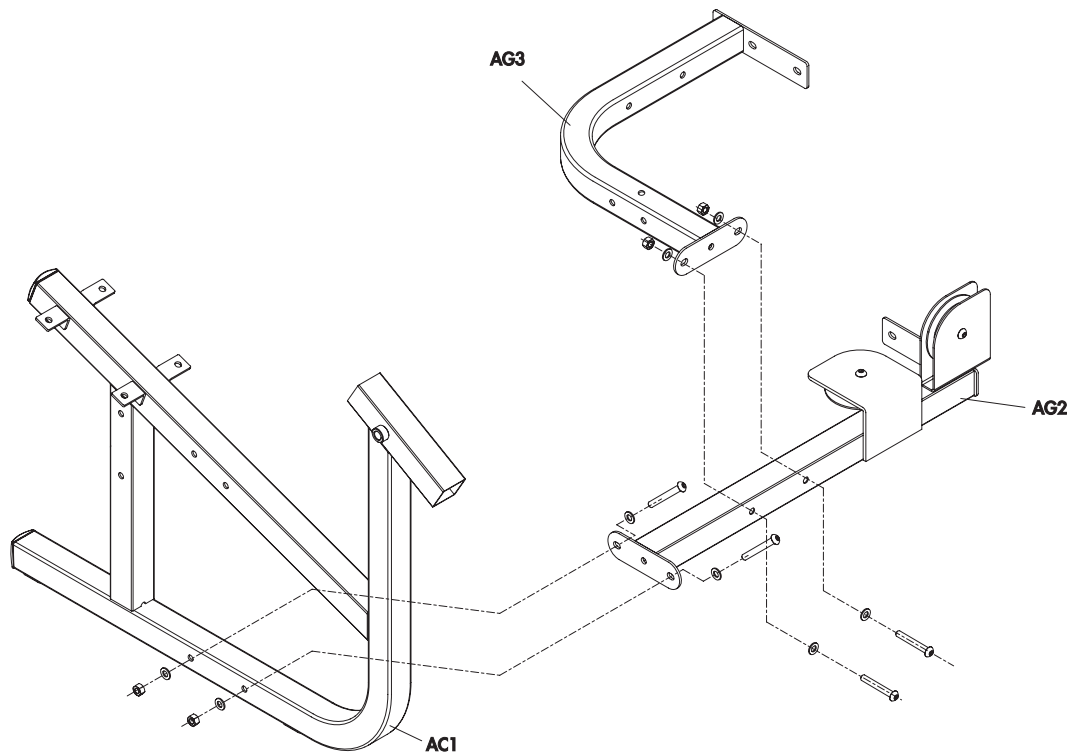

STEP 2**BLUE BAG**

- Stand up the weight stack tower (AB1) and align the bottom holes with the ends of both center and rear floor supports. Fasten together using four bolts (M10x70), eight flat washers (10.2x22x2), and four nylon nuts (M10).

- Attach two pulleys to the weight stack tower with two bolts (M10x48), four flat washers (10.2x22x2) and two nuts (M10).

- Attach the bracket (Z27) to the outside of weight stack tower (see diagram for orientation) with four flat washers (10.2x22.2x2), two bolts (M10x65), and two nuts (M10). Partially tighten.

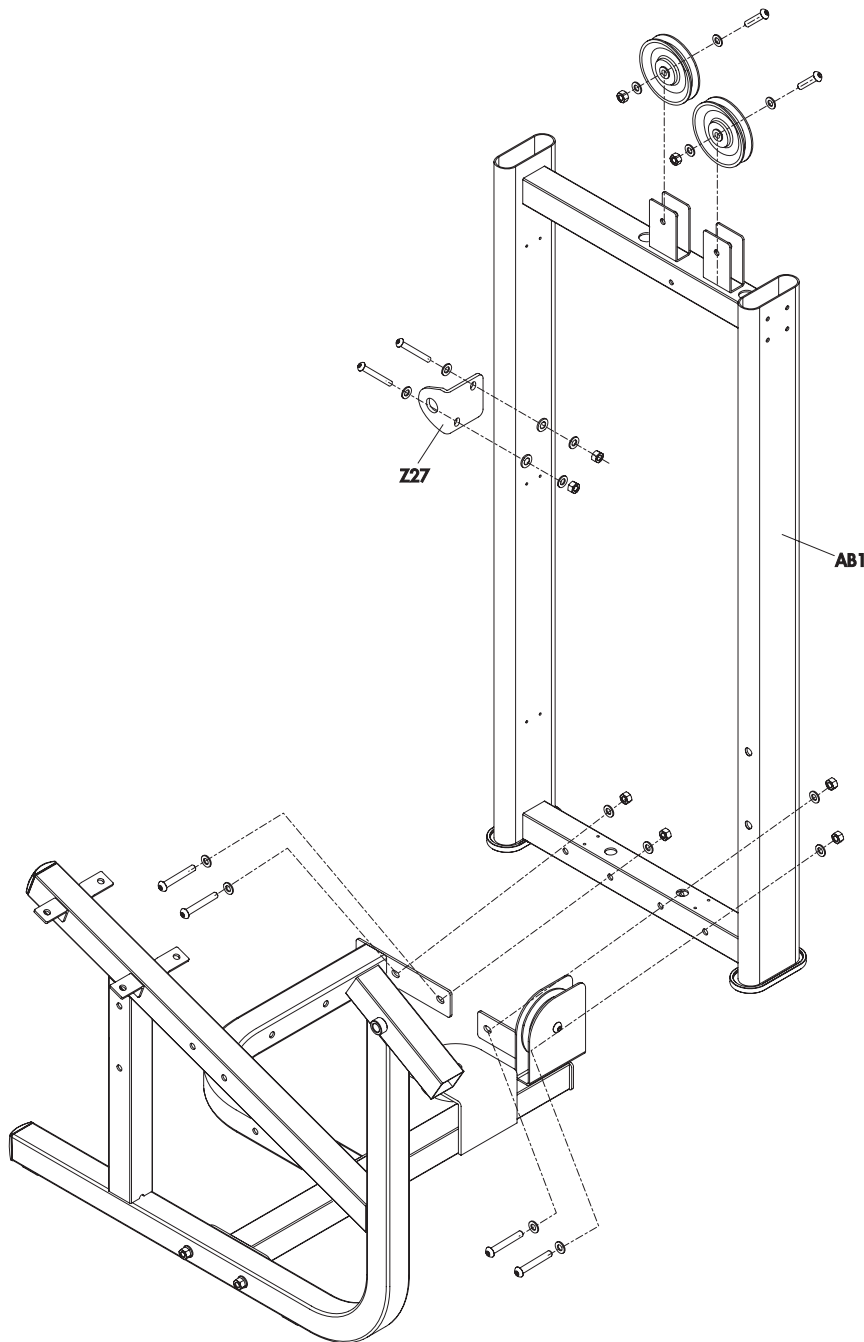

STEP 3**PINK BAG**

- While holding upright, place the bracket end of the swing arm support (AC2) over the holes in center floor support (AG3). The swing arm support should be facing the front of the machine. Secure the support using two bolts (M10x75), four flat washers (10.2x22x2), two nylon nuts (M10). Vertically attach a bolt (M10x25), a lock washer (10.2x18.4x2.5), and a flat washer (10.2x22x2). Wait to tighten all attachments until after this step is completed, as it will allow for easier assembly.

- With the dual pulley bracket (AF1) facing the front align holes in bottom of bracket with remaining holes on the center floor support. Fasten together using two bolts (M10x75), four flat washers (10.2x22x2), two nylon nuts (M10).

- Secure the connecting support frame (AG1) between the swing arm support and the seat support. Use four bolts (M10x70), eight flat washers (10.2x22x2), and four nylon nuts (M10) to attach the connection.

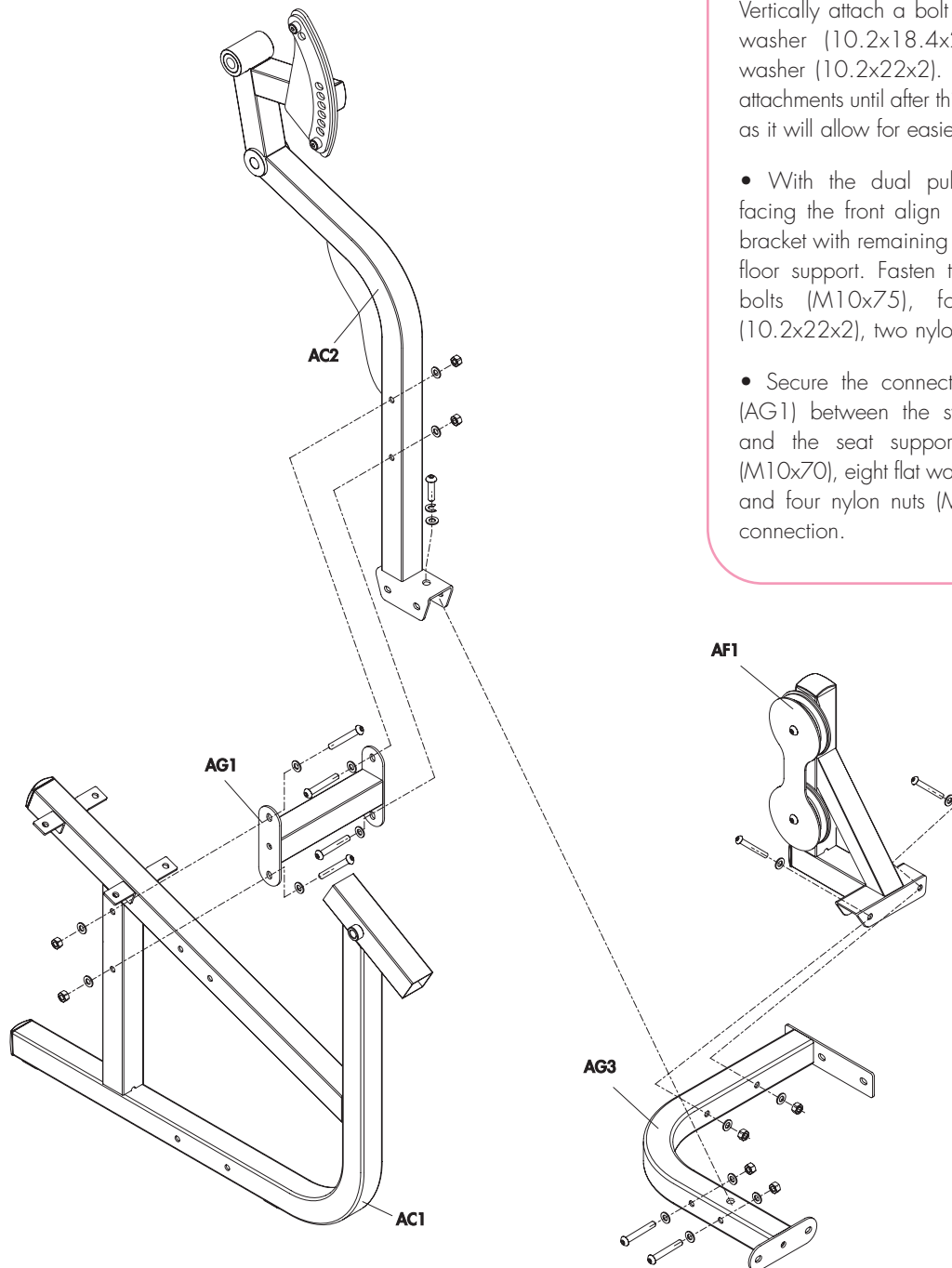

STEP 4**GREEN BAG**

- The swing arm assembly is constructed by inserting the axle (D19) through the bracket (Z27), then adding a wavy washer (20.7x29.1x0.3), range of motion adjustment (AH1), spacer (20.7x26.5x4), and swing arm (AD1). See diagram for orientation. Slide the axle through the hole in the swing arm support (AC2). Attach a flat washer (12.5x50x2), lock washer (12.2x21.5x3), and bolt (M12x25).

- Attach the leg pad (AD2) exercise arm to the lower part of swing arm by lining up the holes and inserting the axle (D20). Attach a lock washer (12.2x21.5x3), flat washer (13x26x2.5), and bolt (M12x25) to each end. Tighten. Make sure the end of the axle with the flat on it is inserted in the exercise arm, mating with the opening that has the flat in it.

- Insert the thigh pad support (AD3) into the remaining slot on the swing arm support and secure using bolt (M12x25), flat washer (26.5x50x2), lock washer (12.2x21.5x3). Make sure the pull pin is inserted in one of the location holes in plate during assembly.

- Tighten all hardware. When tightening weight stack tower bracket (Z27), make sure the axle (D19) is parallel to the floor.

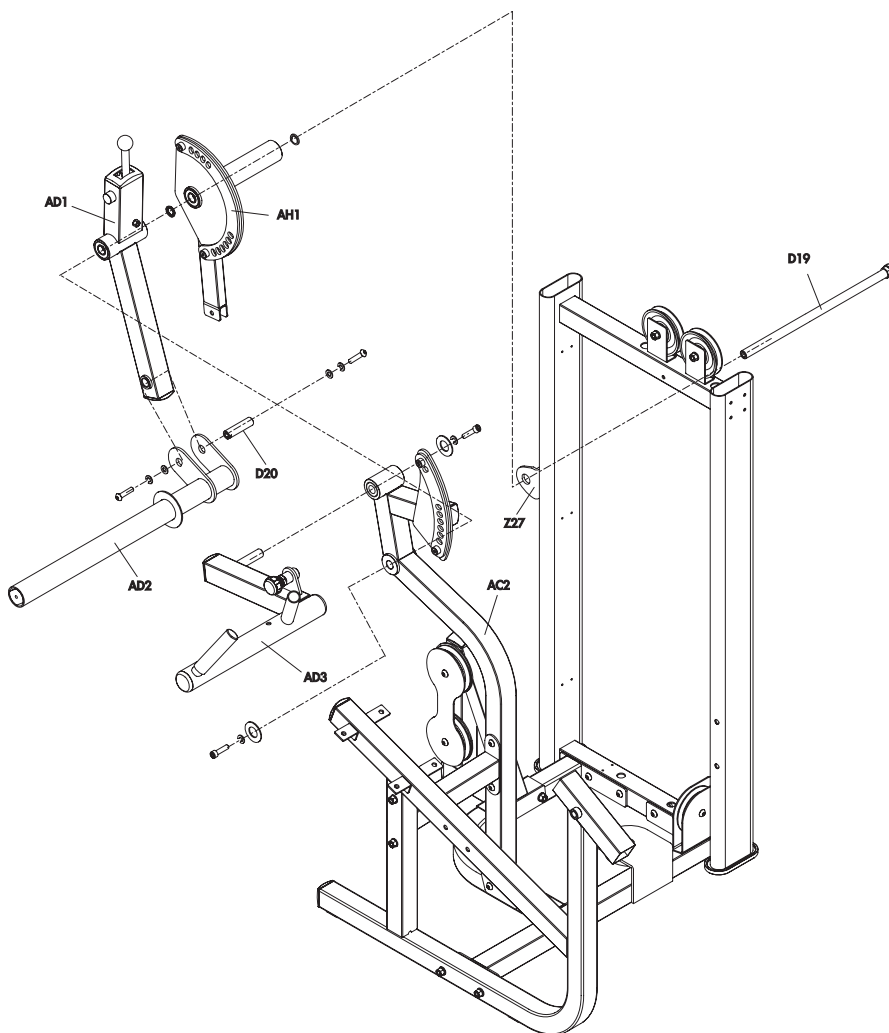

STEP 5**BLACK BAG**

- Loosely secure top and bottom shield brackets (B10) to weight stack tower using bolts (M5x10), flat washers (5.3x10x1), and lock washers (5.1x9.3x1.3) provided. Repeat for all side brackets (B09).

- Place two rubber weight plate bumpers (Z14) over the holes at the bottom of the weight stack tower. With the horizontal holes of the guide rods (K05) at the top, place them over and through the rubber weight plate bumpers into the weight stack tower. Let the guide rods tilt outward from the tower. Slide each of the 15 weight plates (K02) over both of the guide rods on top of one another. Place the header weight plate (K01) over both guide rods on top of other weight plates.

- Make sure rubber guide rod sleeves (Z15) are in place in top holes of the weight stack tower. Lift the guide rods into top of weight stack tower until holes in the guide rod are lined up with the horizontal holes on the top of the weight stack tower. Insert a bolt (M8x62), and a flat washer (8.4x15.5x1.6) through each guide rod and fasten with a flat washer (8.4x15.5x1.6) and a nut (M8).

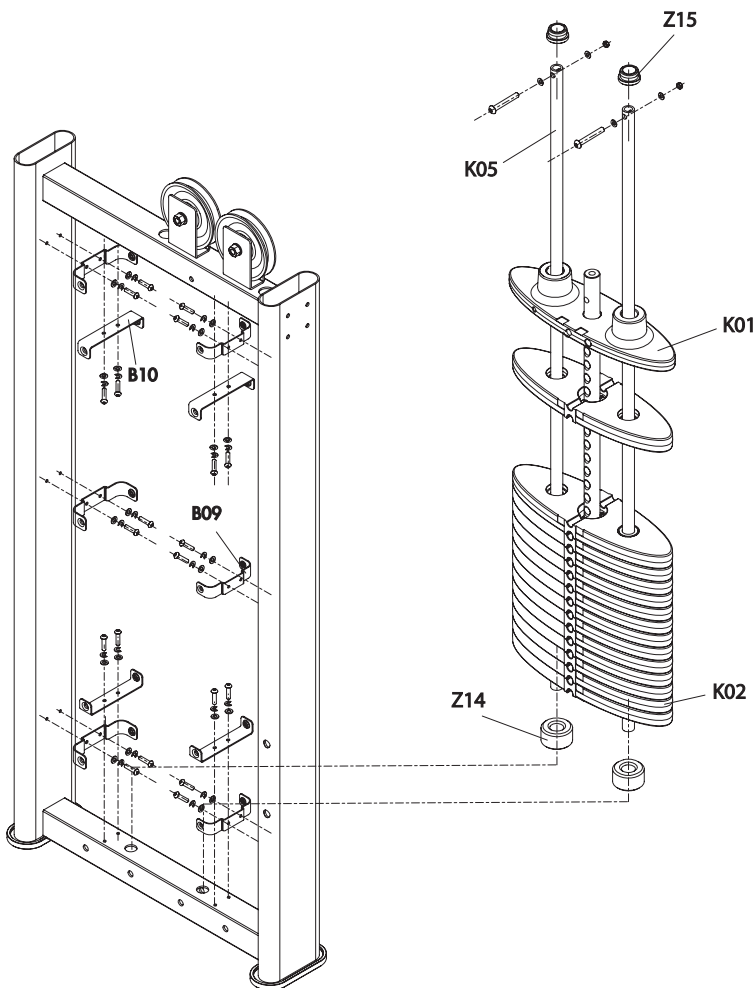

STEP 6**YELLOW BAG**

- With the loop end of the cable in your hand, guide cable through hole in top of weight stack tower and around pulleys A and B. Bring it down along weight stack tower and through pulleys C and D. Cable will then go towards the dual pulley bracket through pulleys E and F, then secure the loop end of the cable at the connection point on the swing arm plate using two spacers (10.2x20x6), one bolt (M8x37.5), a flat washer on each side (10.2x22x2) and one nut (M8).

- Remove nut on bolt end of cable and place the selector pin tether (K08) on bolt shaft. Thread the nut back on the bolt end of the cable all the way to the head of the bolt. Thread the bolt into the header plate, making sure that there is a minimum of 0.5" of engagement. Secure by tightening nut onto header plate (K01).

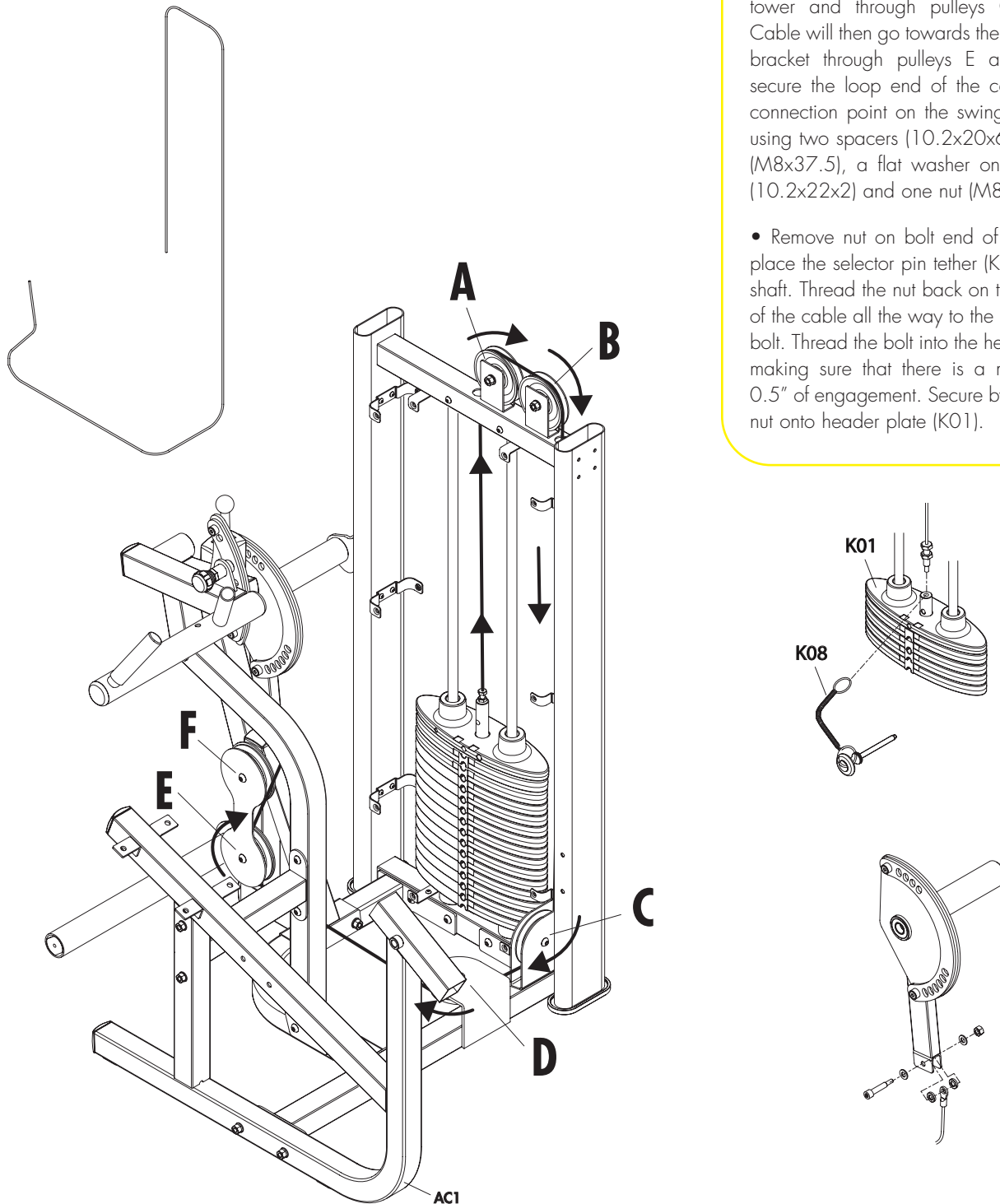

STEP 7**RED BAG**

- Align holes in rear shield (Q03) with the holes in the brackets on the back side of the weight stack; loosely secure using 8 bolts (M5x10). Take the left (Q01) side shield and repeat on front side of weight stack tower using five bolts (M5x10). Tighten interior brackets. Attach the right (Q02) side shield with five bolts (M5x10). Tighten all bolts.

- Attach the slip-on nuts (Z37) to the left weight stack upright openings. Snap the two top covers (Q06 & Q07) together. With tallest point facing the rear of the machine, place the top covers on top of the weight stack tower and secure using six screws (M5x15).

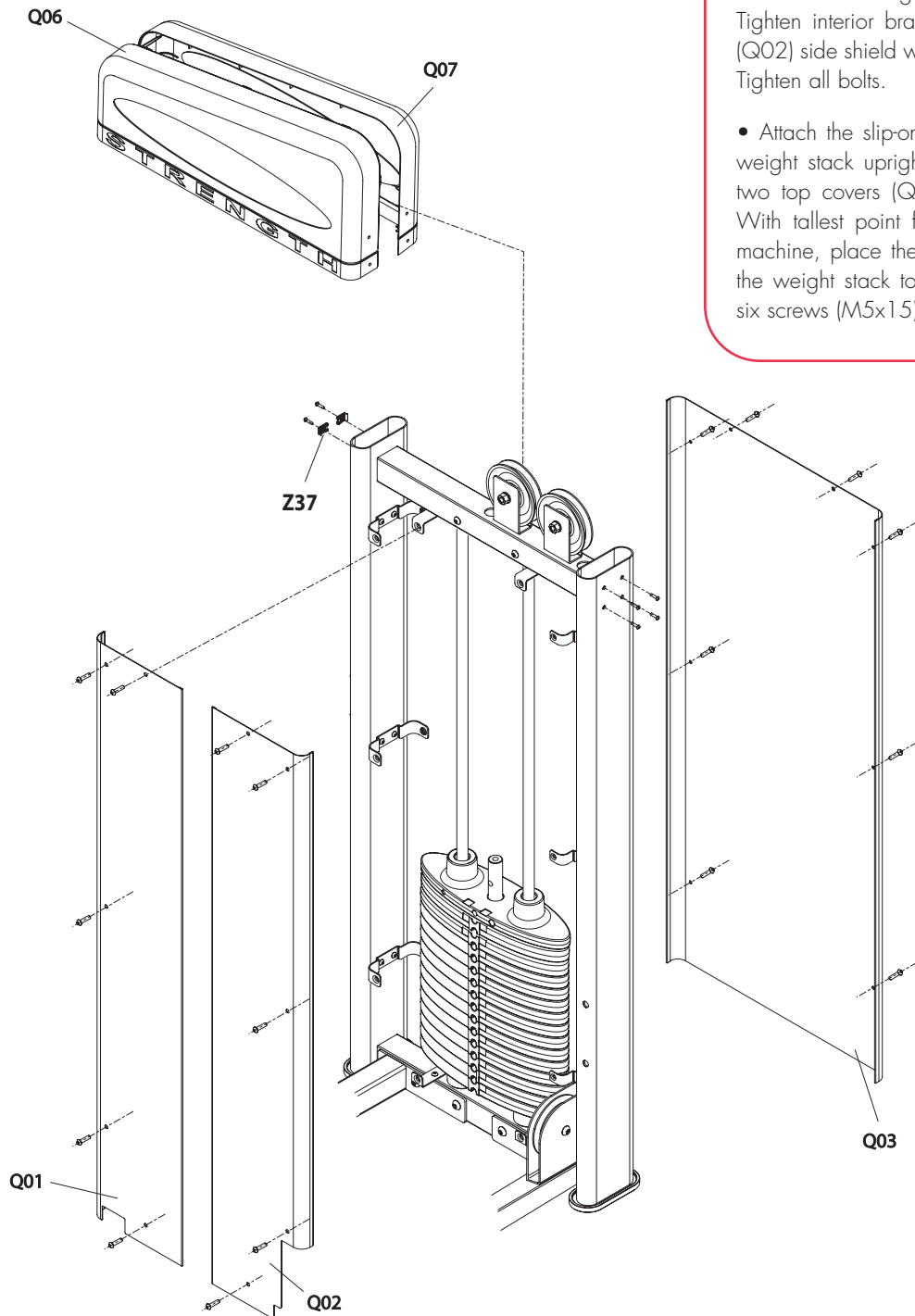

STEP 8**LIGHT BLUE BAG**

- Attach the stabilizer tube (AG4) to the weight stack tower by inserting two bolts (M10x140) and two flat washers (10.2x22x2) through the bracket and the tower tube. Fasten two flat washers (10.2x22x2) and two nylon nuts (M10). Attach two bolts (M10x70), four flat washers (10.2x22x2), and two nylon nuts (M10) to the opposite end of the tube.
- Install the left (AE2) and right (AE1) handlebars on the seat support (AC1) using two bolts (M10x75), four flat washers (10.2x22x2), and two nylon nuts (M10).
- Install seat bottom (J02) on seat support using four bolts (M10x25).
- Mount the thigh pad (J03) onto the thigh support (AD3) using two bolts (M10x70).
- Attach the seat back (J01) to the seat back post (AJ1) using four bolts (M10x25). Insert seat back post into seat back support tube. Thread pull pin into seat back support until the seat back post locks into location.
- Slide leg pad (J04) onto leg pad shaft (AD2) and secure using disc (D41), a flat washer (8.4x15.5x1.6), a lock washer (8.2x15.4x2), and a bolt (M8x25).

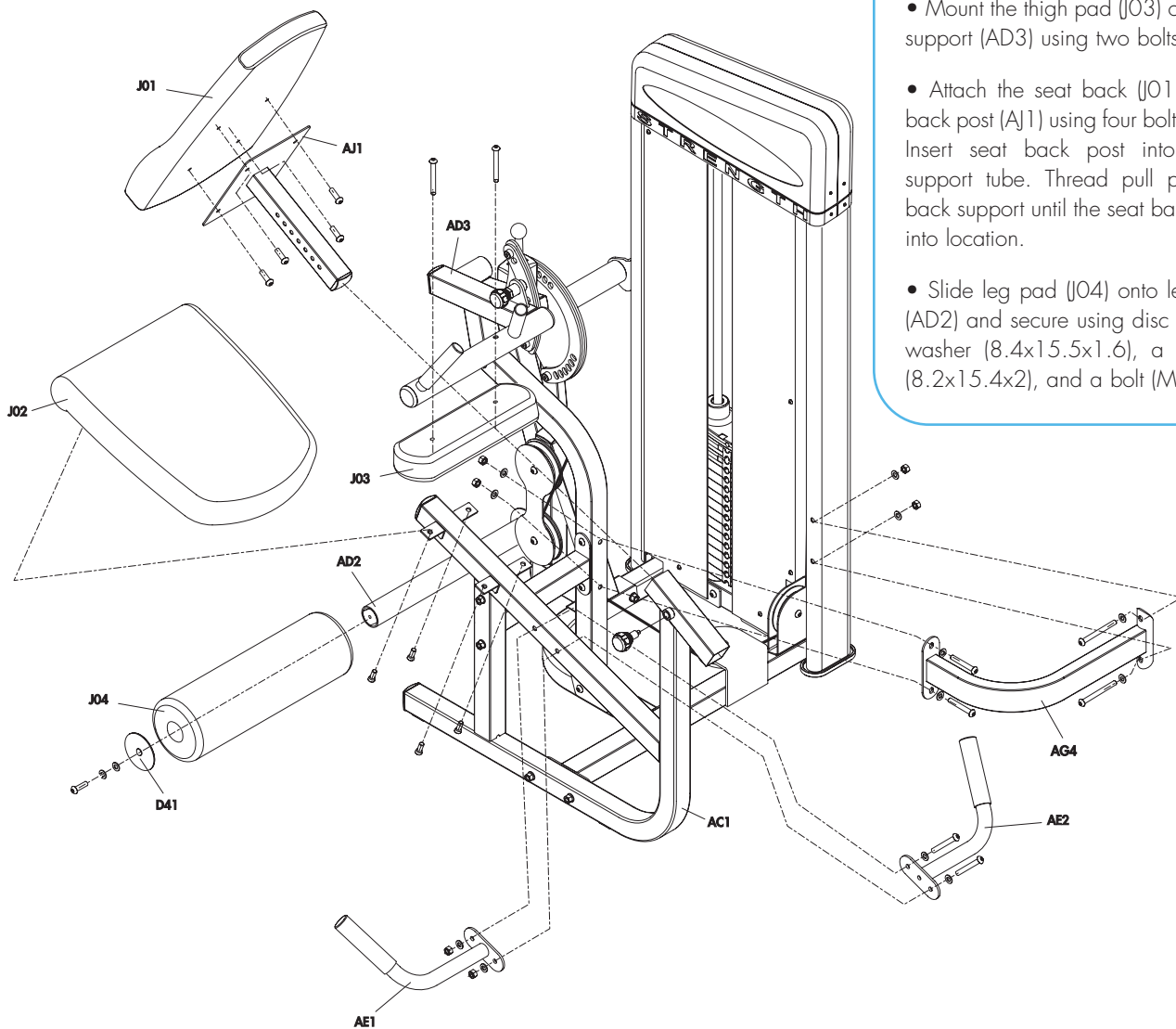

RESISTANCE TRAINING BENEFITS AND TIPS

Always consult a physician before starting an exercise program.

To be successful in your exercise program, it is important to develop an understanding of the basic principles of resistance training. Now that you have assembled your VISION FITNESS gym, it is only natural that you want to get started immediately. First, determine a few realistic, short term goals and expectations for yourself. Choose an appropriate exercise routine that best suits your individual needs. Any of the 3 programs, explained in the Training Programs section below, is a great starting point.

Warm up properly before engaging in resistance training. Stretching, yoga, jogging, calisthenics, or other cardiovascular exercise can help prepare your body for the heavier workload of lifting weights.

Learn how to perform the exercise correctly before using heavy weight. Correct form is important to avoid injury and ensure that you work the proper muscle groups.

Know your limitations. If you are new to resistance training or are starting back, after an extended layoff, start slowly and build foundational strength over a longer period of time.

Pay attention to your breathing. As a general rule of thumb: inhale on the non-exertion part of the movement and exhale during the exertion portion. Never hold your breath.

Keep in mind how important the recovery phase is in achieving your goals. The general rule is to allow a minimum of 48-72 hours before training the same muscle/s. If you still experience soreness after this period of time has elapsed, take a few additional days until the soreness has subsided.

Use this manual to guide you through the basic exercises you can perform on your VISION FITNESS gym. To achieve maximum results and avoid possible injury, consult a fitness professional to formulate a complete exercise program.

WORKOUT VARIATIONS

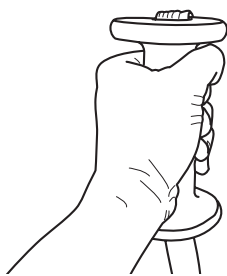

NEUTRAL GRIP

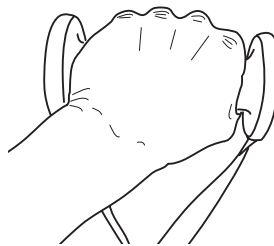

OVERHAND OR PRONATED GRIP

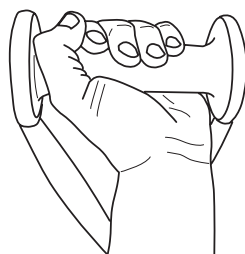

UNDERHAND OR SUPINATED GRIP

TRAINING PROGRAMS

MUSCULAR ENDURANCE

A program that stresses moderate intensity, a lower amount of resistance, and higher repetitions (anywhere from 13-100 or more). These types of sets will take longer to complete. This type of training conditions the muscles for activities that stress the slow twitch muscle fibers of your body. This is beneficial for sustaining energy over moderate periods of time.

MUSCULAR STRENGTH

A program that stresses high intensity, a higher amount of resistance, and lower repetitions (anywhere from 6-12). These types of sets will take a shorter period of time to complete. This type of training conditions the muscles for activities that stress the fast twitch muscle fibers of the body. This is beneficial for activities that require short bursts of speed and power.

SPRINT 8

This program is exclusive to VISION FITNESS exercise equipment. This is a program that stresses high intensity, a moderate amount of resistance, and as many repetitions that a person can perform in a specified period of time (usually 20-30 seconds). This program works especially well for the time crunched exerciser. It allows you to work both the slow and fast twitch muscle fibers of the body. This program gives you a good cardiovascular and strength workout. The thing that is most appealing about this program is that an individual can complete it in 20 minutes.

This is how the program works:

The person picks the number of exercises they want to perform. Examples would be 1, 2, 4, or 8 exercises. The individual completes a 3 minute warm up with a brisk walk or on a piece of cardiovascular equipment. After the warm up is complete, the user begins performing the first exercise maintaining a high intensity pace throughout the determined amount of time (20-30 seconds). After this period of time, the individual can perform an active, low intensity recovery phase, stretching, or complete rest. This should last 1.5-2 minutes or less, if you are at a higher fitness level. After the recovery phase, the individual performs the second high intensity exercise for the required amount of time (20-30 seconds). This is followed by the second recovery phase. This process repeats until you are done with 8 high intensity intervals. Finish the workout by completing a 3-5 minute very low intensity cool down.

STRETCHING

Flexibility Training is not associated with fitness as often as cardiovascular exercise or Strength Training, even though it is just as important. A good stretching program will help to maintain flexibility of the hips and lower back. A flexible person will be less likely to injure themselves in common activities, such as reaching, twisting and turning, or in uncommon activities such as the annual softball tournament.

Before stretching, take a few minutes to warm up the muscles because stretching a cold muscle can cause injury. Start your stretch slowly, exhaling as you gently stretch the muscle. Try to hold each stretch 15 to 30 seconds. Don't bounce when you stretch. Holding a stretch offers less chance of injury. Don't strain or push a muscle too far. If it hurts, ease up. Here are a few stretches you can incorporate into your exercise program:

SEATED TOE TOUCH (HAMSTRINGS & LOWER BACK)

Sit on the floor with your legs together and straight out in front of you. Do not lock your knees. Extend your fingers toward your toes, exhaling as you go. Hold for 15 to 30 seconds. Return to the start position, and repeat as necessary.

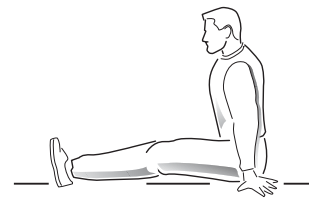

STANDING QUADRICEPS STRETCH

Using a wall to provide balance, grasp your left ankle with your left hand and hold to stretch. Your knee should be pointing toward the floor. Hold the stretch for 15 to 30 seconds. Repeat with your right leg, and continue to alternate as necessary.

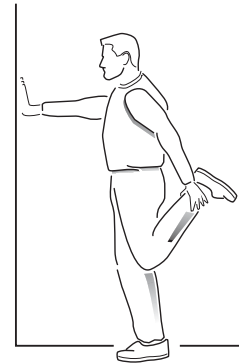

STANDING CALF STRETCH

Standing about three to four feet from the wall, take one step forward with your right foot. Place your hands on the wall in front of you. Bend your right leg slowly, using your movement to control the amount of stretch in the left calf. Your left heel should remain on the ground. Slowly bring yourself back to the starting position and switch legs. Repeat as necessary.

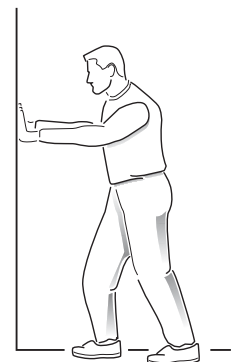

BICEP/CHEST STRETCH

Grasp an immovable object (pole or corner of a wall) with your feet planted firmly and evenly on the floor. With the palm of your stretched side facing forward, rotate your hips away from that hand. **Be careful not to rotate too far or hyperextend the elbow joint.** Hold the stretch for 15 to 30 seconds. Repeat with the opposite side, and continue to alternate as necessary.

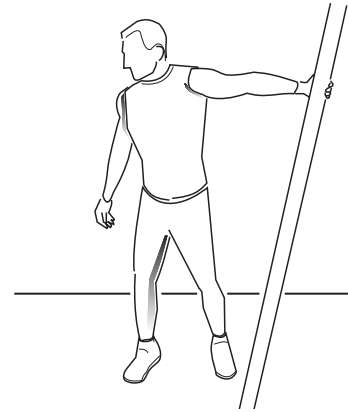

TRICEP STRETCH

Stand erect with your eyes fixated straight ahead. Raise and bend your right arm until your forearm is parallel to the floor (palm down). Grasp the area below the right elbow with your left hand. Gently apply a constant upward force for 15 to 30 seconds. Switch arms and repeat as necessary.



SHOULDER STRETCH

Make sure your feet are even and planted firmly on the floor. Grasp your right arm, behind the elbow, with your left hand. While keeping both elbows bent, apply a gentle, constant pull to the left for 15 to 30 seconds. Switch arms and repeat as necessary.

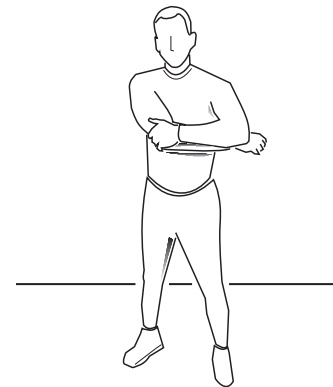

UPPER BACK STRETCH

Stand facing an immovable object, feet even and flat on the floor. Grasp the object (fingers interlocked or one hand over the other) and slowly move your hips to the rear. **Be very careful not to round your back.** Only stretch as far as your comfort zone. Hold for 15 to 30 seconds and repeat as necessary.

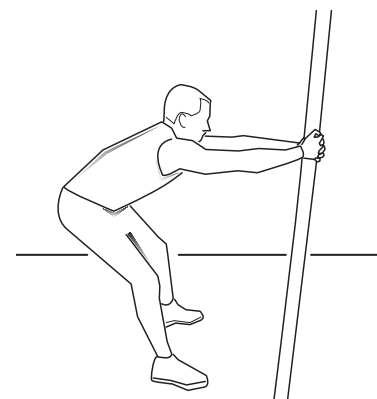

MAINTENANCE SCHEDULE

FOR *BEST PERFORMANCE* WE RECOMMEND THE FOLLOWING MAINTENANCE SCHEDULE:

Check the integrity and function of the following parts. Replace all worn components immediately.

ITEM	DAILY	WEEKLY
CABLES CHECK END FITTINGS AND CABLE JACKET COATING. CHECK TIGHTNESS OF WEIGHT STACK LOCKING NUT. REPLACE CABLES ANNUALLY.	•	•
UPHOLSTERY WIPE DOWN AND DRY. CLEAN AND CONDITION.	•	•
FRAME WIPE WITH WATER DAMPENED CLOTH AND DRY COMPLETELY. POLISH AND WAX.	•	•
CHROME WIPE WITH WATER DAMPENED CLOTH AND DRY COMPLETELY. POLISH AND WAX.	•	•
NUTS/BOLTS/FASTENERS TIGHTEN AND/OR ADJUST AS NEEDED.		•
GUIDE RODS LUBRICATE AND CLEAN.		•
ADJUSTMENTS/LOCKING PINS/TIGHTENING KNOBS		•
WEIGHT STACK PIN		•
WARNING/INSTRUCTION LABELS		•
ANTI-SKID GRIP TAPE		•
HAND GRIPS		•
GREASE PILLOW BLOCK BEARINGS OF LEG PRESS		•

ST750 COMMERCIAL WARRANTY*

COMMERCIAL USES DEFINED VISION FITNESS warrants the ST750 model Leg Extension/Curl for use in commercial facilities. Examples of commercial facilities include but are not limited to: Hotels; Resorts; Police and Fire Stations; Apartment Complexes; Rehabilitation and Sports Medicine Clinics; Hospitals; Elementary, Middle, and High Schools; YMCAs; Private Health Clubs; Colleges and Universities.

FRAME, WELDS, WEIGHT PLATES, & GUIDE RODS - LIFETIME VISION FITNESS warrants the Frame, Welds, Weight Plates and Guide Rods against defects in workmanship and materials for the life of the product, as long as it remains in the possession of the original owner.

BUSHINGS, ROTATING BEARINGS, & PULLEYS - FIVE YEARS VISION FITNESS warrants these components against defects in workmanship and materials for a period of five years from the date of original purchase, so long as the device remains in the possession of the original owner.

CABLES, LINEAR BEARINGS, SHAFTS, & OTHER PARTS - ONE YEAR VISION FITNESS warrants these components against defects in workmanship and materials for a period of one year from the date of original purchase, so long as the device remains in the possession of the original owner.

EXCLUSIVE REMEDY

The exclusive remedy for any of the above warranties shall be repair or replacement of defective parts.

EXCLUSIONS AND LIMITATIONS

This warranty applies only to the original owner and is not transferable. This warranty is expressly limited to the repair or replacement of a defective frame, electronic component, or defective part and is the sole remedy of the warranty. The warranty does not cover normal wear and tear, improper assembly or maintenance, or installation of parts or accessories not originally intended or compatible with the product as sold. This warranty does not cover failure to follow instructions and warnings in the Owner's Guide or failure to provide reasonable and necessary maintenance. This warranty does not apply to damage or failure due to accident, abuse, corrosion, discoloration of paint or plastic or neglect. VISION FITNESS shall not be responsible for incidental or consequential damages. Parts and electronic components reconditioned to As New Condition by VISION FITNESS or its vendors may sometimes be supplied as warranty replacement parts and constitute fulfillment of warranty terms. Any warranty replacement parts shall be warranted for the remainder of the original warranty term.

VISION FITNESS expressly disclaims all other warranties, express or implied, including but not limited to all warranties of fitness for a particular purpose or of merchantability. This warranty gives you specific rights and your rights may vary from state to state.

WARRANTY REGISTRATION

Your warranty card must be completed and sent to VISION FITNESS before a warranty claim can be processed. You may also register via our website at www.visionfitness.com. Inside the enclosed warranty card you will find a customer survey. Your care in completing the survey will be of value to us in serving you in the future. Comments and suggestions are always welcome. We are certain you will enjoy your new treadmill. Thank you for selecting a VISION FITNESS product.

*ST750 Commercial Warranty valid in North America only

Week #

Weekly Goals: _____

Scheduled Workout Time: _____

Reward: _____

Day	Date	Exercise	Sets	Reps	Weight
Sunday					
Monday					
Tuesday					
Wednesday					
Thursday					
Friday					
Saturday					
Totals					

Week #

Weekly Goals: _____

Scheduled Workout Time: _____

Reward: _____

Day	Date	Exercise	Sets	Reps	Weight
Sunday					
Monday					
Tuesday					
Wednesday					
Thursday					
Friday					
Saturday					
Totals					

Week #

Weekly Goals: _____

Scheduled Workout Time: _____

Reward: _____

Day	Date	Exercise	Sets	Reps	Weight
Sunday					
Monday					
Tuesday					
Wednesday					
Thursday					
Friday					
Saturday					
Totals					

Week #

Weekly Goals: _____

Scheduled Workout Time: _____

Reward: _____

Day	Date	Exercise	Sets	Reps	Weight
Sunday					
Monday					
Tuesday					
Wednesday					
Thursday					
Friday					
Saturday					
Totals					

Week #

Weekly Goals: _____

Scheduled Workout Time: _____

Reward: _____

Day	Date	Exercise	Sets	Reps	Weight
Sunday					
Monday					
Tuesday					
Wednesday					
Thursday					
Friday					
Saturday					
Totals					

Week #

Weekly Goals: _____

Scheduled Workout Time: _____

Reward: _____

Day	Date	Exercise	Sets	Reps	Weight
Sunday					
Monday					
Tuesday					
Wednesday					
Thursday					
Friday					
Saturday					
Totals					

Week #

Weekly Goals: _____

Scheduled Workout Time: _____

Reward: _____

Day	Date	Exercise	Sets	Reps	Weight
Sunday					
Monday					
Tuesday					
Wednesday					
Thursday					
Friday					
Saturday					
Totals					

Week #

Weekly Goals: _____

Scheduled Workout Time: _____

Reward: _____

Day	Date	Exercise	Sets	Reps	Weight
Sunday					
Monday					
Tuesday					
Wednesday					
Thursday					
Friday					
Saturday					
Totals					

*it all
starts
with a
v i s i o n*

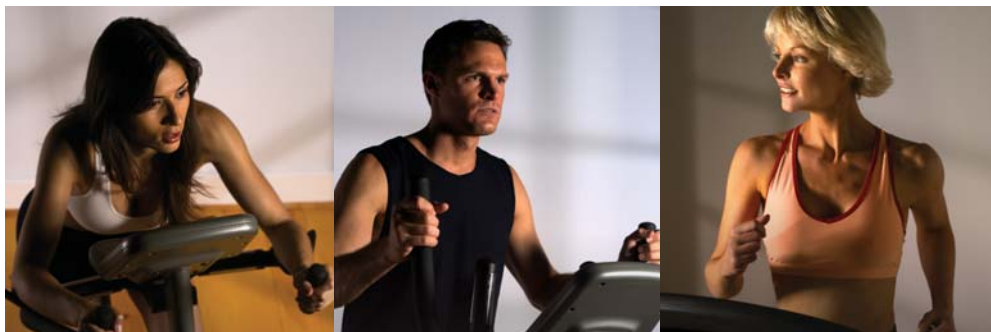

VISION  FITNESS®

500 South CP Avenue • P.O. Box 280 • Lake Mills, WI 53551
toll free 800.335.4348 • phone 920.648.4090 • fax 920.648.3373
www.visionfitness.com

©2006 Vision Fitness. All Rights Reserved. 11.06
OM18.48PRD
REV1

Free Manuals Download Website

<http://myh66.com>

<http://usermanuals.us>

<http://www.somanuals.com>

<http://www.4manuals.cc>

<http://www.manual-lib.com>

<http://www.404manual.com>

<http://www.luxmanual.com>

<http://aubethermostatmanual.com>

Golf course search by state

<http://golfingnear.com>

Email search by domain

<http://emailbydomain.com>

Auto manuals search

<http://auto.somanuals.com>

TV manuals search

<http://tv.somanuals.com>