

VISION  FITNESS



Owner's Guide

**E3600HRC, R2600HRC,
T8600S/HRC & X6600HRC/DA**



Table of Contents

E3600HRC

R2600HRC

SAFETY INSTRUCTIONS	4
MOVING & LEVELING	6
SEAT ADJUSTMENTS	7,8
EASY-8™ CONSOLE	8
POWER, ONE-BUTTON START™	9
PROGRAM DETAILS	10
FEEDBACK DISPLAY	11
PROGRAMMING	12
USING HEART RATE PROGRAM	13
ABOUT HEART RATE CONTROL	14
TARGET HEART RATE ZONE	15
TROUBLESHOOTING	16
TROUBLESHOOTING HR STRAP	17
COMMON QUESTIONS	18
HOME USE WARRANTY	20
LIGHT COMMERCIAL WARRANTY	22

T8600S&HRC

SAFETY INSTRUCTIONS	26
MOVING & LEVELING	30
POWER, EMERGENCY STOP	31
ONE-BUTTON START - T8600S	32
FEEDBACK DISPLAY - T8600S	33
ONE-BUTTON START - T8600HRC	34
PROGRAM DETAILS - T8600HRC	35
FEEDBACK DISPLAY - T8600HRC	36
PROGRAMMING - T8600HRC	38
HRC PROGRAM - T8600HRC	39

ABOUT HRC - T8600HRC	40
TARGET HR ZONE - T8600HRC	41
TROUBLESHOOTING	42
TROUBLESHOOTING HR STRAP	43
COMMON QUESTIONS	44
TENSIONING THE BELT	45
HOME USE WARRANTY	46
LIGHT COMMERCIAL WARRANTY	48

X6600HRC&DA

SAFETY INSTRUCTIONS	52
MOVING & LEVELING	54
FOOT POSITIONS	55
EASY-8™ CONSOLE	56
POWER, ONE-BUTTON START™	57
PROGRAM DETAILS	58
FEEDBACK DISPLAY	59
PROGRAMMING	60
USING HRC PROGRAM	61
ABOUT HEART RATE	62
TARGET HEART RATE ZONE	63
ABOUT X6600HRC DUAL ACTION	64
TROUBLESHOOTING	66
TROUBLESHOOTING HR STRAP	67
COMMON QUESTIONS	68
HOME USE WARRANTY	70
LIGHT COMMERCIAL WARRANTY	72
YOUR FITNESS PROGRAM	74
STRETCHING	75
EXERCISE GUIDELINES	76
WEEKLY LOG SHEETS	80
MONTHLY LOG SHEETS	82

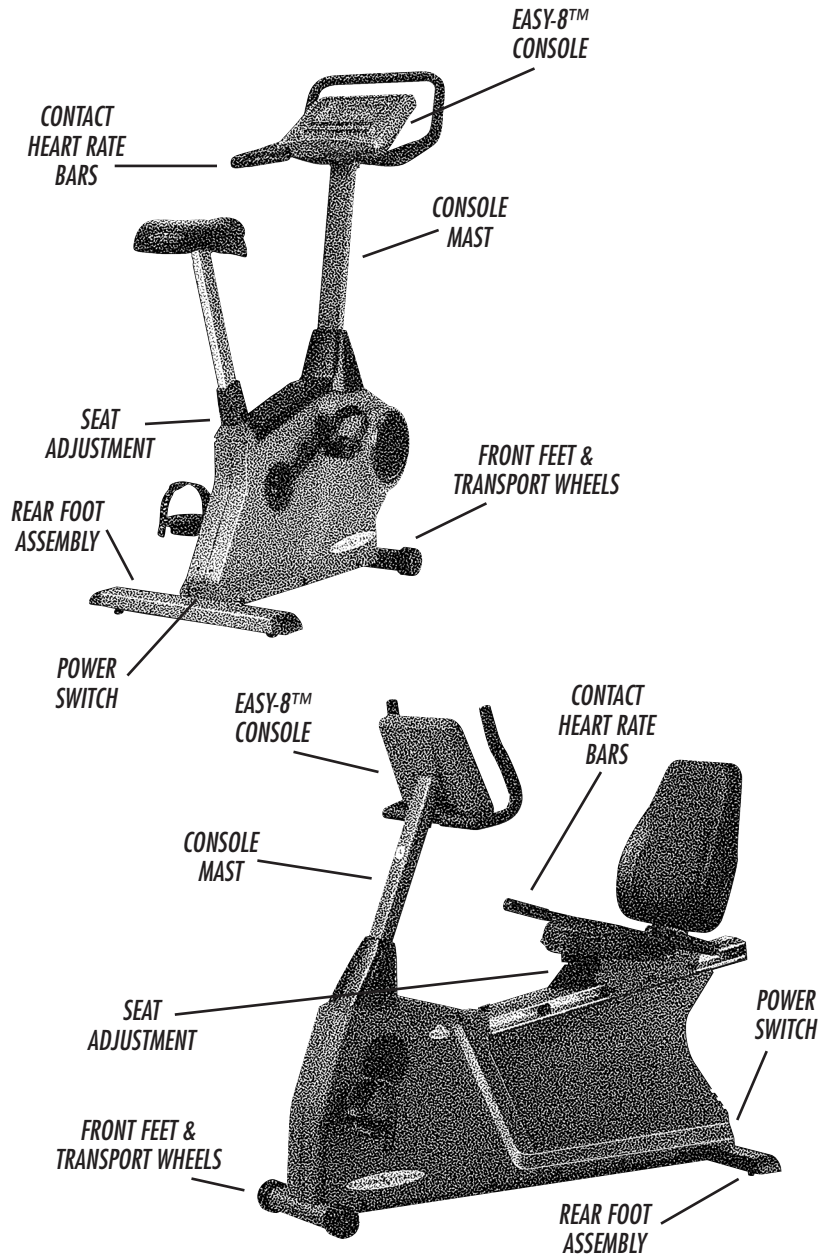

E 3 6 0 0 H R C

upright & semi-recumbent

R 2 6 0 0 H R C

IMPORTANT SAFETY INSTRUCTIONS

SAVE THESE INSTRUCTIONS

When using an electrical product, basic precautions should always be followed, including the following:

Read all instructions before using this exercise product.

Your VISION FITNESS Bike is self-generating (requiring no external power source) and in this mode must be pedaled to power-up the console. Alternatively, the Bike can instead be plugged into an outlet using the included power supply.

WARNING! To reduce the risk of burns, fire, electrical shock or injury to persons:

- Use this exercise product for its intended use as described in this Owner's Guide. Do not use attachments not recommended by the manufacturer.
- Never drop or insert any object into any opening.
- Do not remove the Bike sidecovers. Service should be performed only by an authorized VISION FITNESS retailer.
- Never operate this Bike if it has a damaged cord or plug, if it is not working properly, if it has been damaged, or immersed in water. Return the Bike to a retailer for examination and repair.
- Keep the cord away from heated surfaces.
- Do not use outdoors.
- To disconnect, turn the switch to the OFF position, then remove plug from outlet.
- Only use the power cord provided with your VISION FITNESS Bike.
- Never place the power cord under carpeting or place any object on top of the power cord, which may pinch and damage it.
- Unplug your VISION FITNESS Bike before moving it.

CHILDREN

- Keep children off your VISION FITNESS Bike at all times.
- When the VISION FITNESS Bike is in use, young children and pets should be kept at least 10 feet away.

OTHER SAFETY TIPS FOR YOUR VISION FITNESS BIKE

CAUTION! If you experience chest pains, nausea, dizziness or shortness of breath, stop exercising immediately and consult your physician before continuing.

- Do not wear clothing that might catch on any part of the Bike.
- Read this Owner's Guide before operating this Bike.

CLEANING

- Clean with soap and slightly damp cloth only; never use solvents.

E 3 6 0 0 H R C

upright & semi-recumbent

R 2 6 0 0 H R C

MOVING

Your VISION FITNESS Bike has a pair of transport wheels built into the front legs. To move the E3600, firmly grasp the handlebars, carefully tip toward you and roll on the transport wheels. To move the R2600, firmly grasp the rear foot assembly, carefully lift and roll on the transport wheels.

CAUTION: Our Bikes are well-built and heavy, weighing up to 140 lbs.! Use care and additional help if necessary.

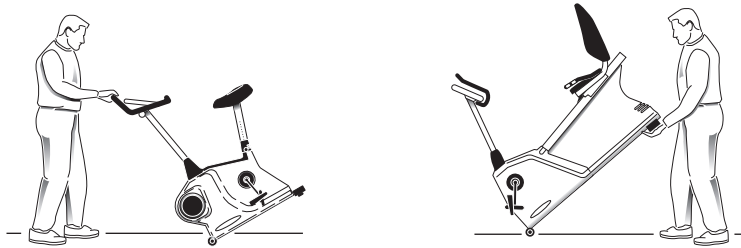

LEVELING

The Bike should be level for optimum use. If your Bike wobbles when you have placed it where you intend to use it, raise or lower one or both of the adjustable levelers located on the bottom of the rear foot support. Once you have leveled the Bike, lock the levelers in place by tightening the wing nuts against the rear foot support.

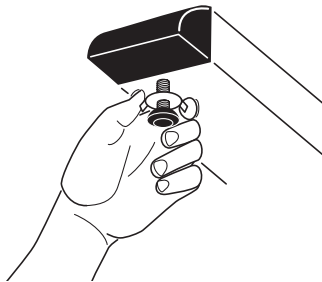

6

E3600HRC

R2600HRC

upright & semi-recumbent

SEAT ADJUSTMENTS

SEAT POSITIONING

The seat is at the proper position when your knee is slightly bent when the pedal is in the furthest position, with the ball of your foot centered on the pedal.

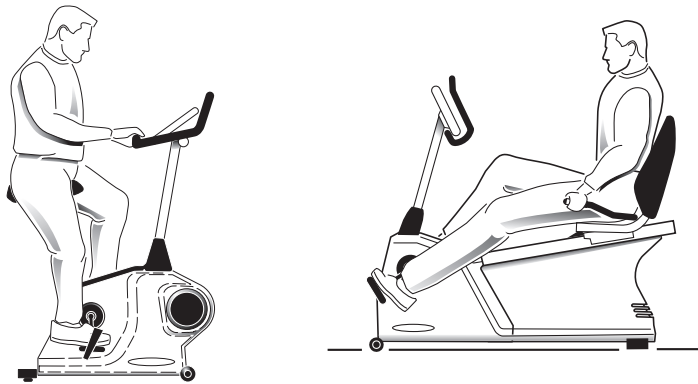

E3600HRC SEAT ADJUSTMENT

Grasp the Seat Adjustment Knob, located at the base of the seatpost. Pull the Knob out, then raise or lower the seatpost to the desired height. Release the Knob and allow the seatpost to lock into position.

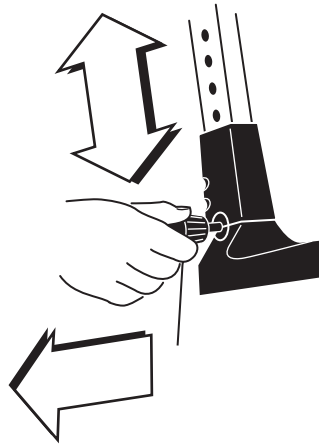

7

E3600HRC

upright & semi-recumbent

R2600HRC

R2600HRC SEAT ADJUSTMENT

SEAT POSITION

While seated on the Bike, lift the Seat Lever and slide the seat forward or back. When the seat is positioned properly, simply release the Seat Lever to lock the seat into position.

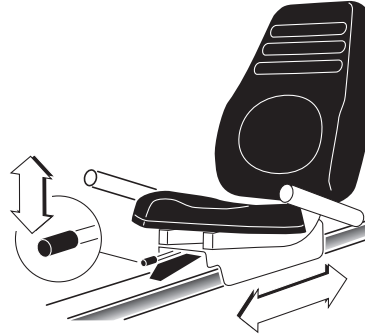

EASY-8™ CONSOLE

Your EASY-8™ Console arrives preset to display Miles. If you wish to display Kilometers instead, remove the Console from the Console Mast by removing the four mounting bolts. Inside the mounting recess you will find a small switch; move this MPH/KM Conversion Switch to the right to display Kilometers. Remount the Console to the Console Mast.

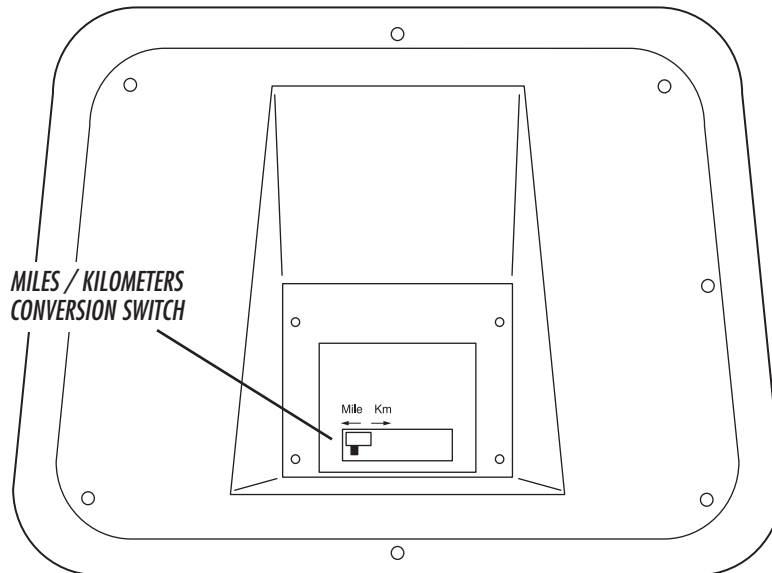

8

E3600HRC

R2600HRC

upright & semi-recumbent

GETTING STARTED

POWER

Your Bike is self-generating (requiring no external power source) and in this mode must be pedaled to power-up the Console. Alternatively, the Bike can also be plugged into an outlet using the included power supply. If using the Bike in this mode, ensure that it is properly connected to the power outlet, then turn on the Power switch, located near the power supply.

ONE-BUTTON START™

Simply press the Start button to begin exercising in the manual Program.

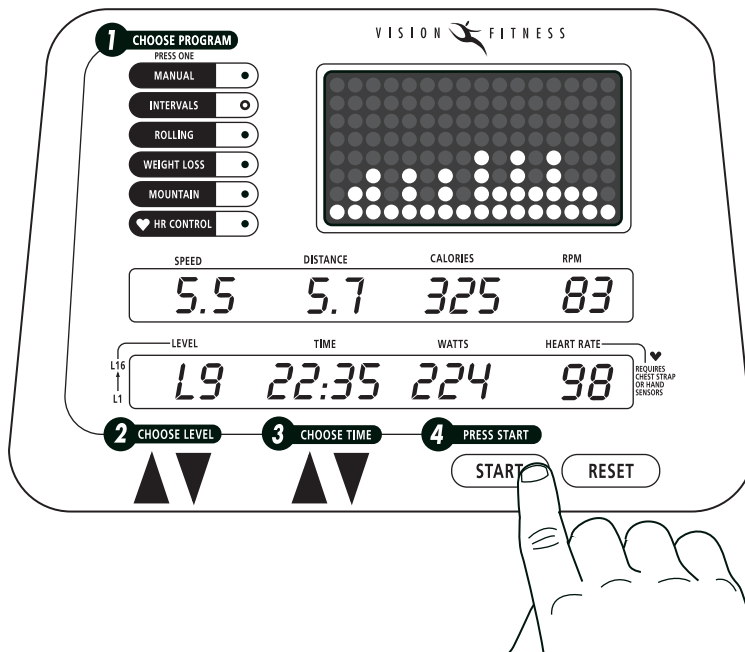

9

E3600HRC

upright & semi-recumbent

R2600HRC

PROGRAM DETAILS

MANUAL Customized workouts; with no default Time.

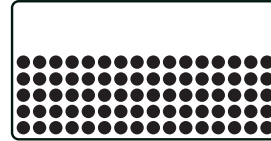

INTERVALS Improves your strength, speed, and endurance by raising and lowering the resistance Level throughout your workout to involve both your heart and muscles; Time defaults to 24 minutes.

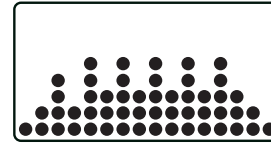

ROLLING Maintains weight by gradually raising and lowering the resistance Level to gradually raise and lower your Heart Rate; Time defaults to 32 minutes.

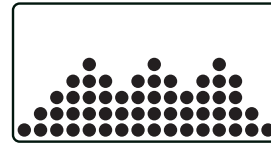

WEIGHT LOSS Promotes weight loss by raising and lowering the resistance Level, but still keeps you in your fat-burning zone; Time defaults to 48 minutes.

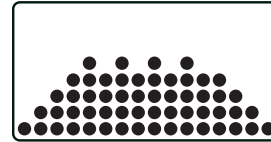

MOUNTAIN Improves performance by raising resistance Level to a high peak then lowering again; Time defaults to 48 minutes.

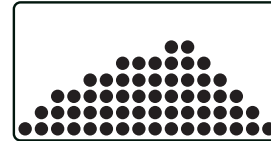

HR CONTROL Saves time by making the most of your limited workout time; motivates and encourages you to achieve your fitness goals. Benefits weight loss by maintaining an optimum exercise level to burn fat; Time defaults to 24 minutes.



10

NOTE: In addition to the specific benefits listed, all the Programs can provide an aerobic and cardiovascular benefit.

E 360HRC

R 260HRC

upright & semi-recumbent

FEEDBACK DISPLAY



SPEED

Shown as Miles per Hour or Kilometers per Hour. View the current cycling Speed.

DISTANCE

Shown as Miles or Kilometers. View Distance during workout.

CALORIES

Shown as total accumulated Calories burned during workout.

RPM

Shown as Revolutions per Minute. Improve cycling technique while reducing leg muscle fatigue by pedaling between 80 & 100 RPMs.

PROGRAM LEVEL

View the current chosen Program Level. Indicates the difficulty of your workout, with L1 being the easiest and L16 being the most difficult.

TIME

Shown as Minutes:Seconds. View the Time remaining or the Time elapsed in your workout.

WATTS

A measurement of your expended energy. May be used to evaluate and quantify your fitness progress over time.

HEART RATE

Shown as Beats per Minute. You can monitor your Heart Rate at any time during a workout.

FINISHING

When your work-out is complete the Display windows will begin flashing your workout information, allowing you to record it in your personal logbook. If you are using the Bike with the external power supply, the workout information will flash for 5 minutes.

NOTE: If you are instead using the Bike in the self-generating mode, your workout information will flash only as long as you continue pedaling.

E3600HRC

upright & semi-recumbent

R2600HRC

CHOOSING A PROGRAM

If you do not choose a Program, the EASY-8™ Console will default to the MANUAL Program. If you wish to choose another Program, simply press one of the other Program buttons.

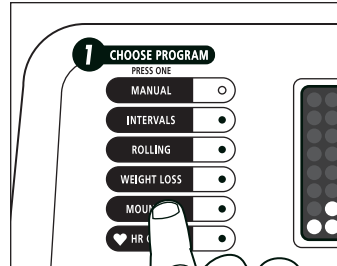

CHOOSING A LEVEL

After you have chosen a Program, the Level will default to L6 and then flash. You may use this default Level or choose another by using the Arrow buttons; L1 provides the least resistance, L16 the most.

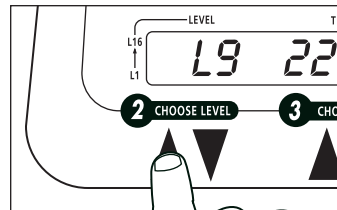

CHOOSING A TIME

After you have chosen a Level, the Time will default, depending on which Program you have chosen, and then flash. You may use this default Time or choose another by using the Arrow buttons.

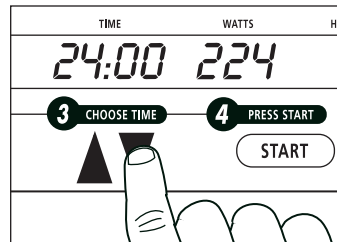

STARTING

When you are ready to begin exercising press START.

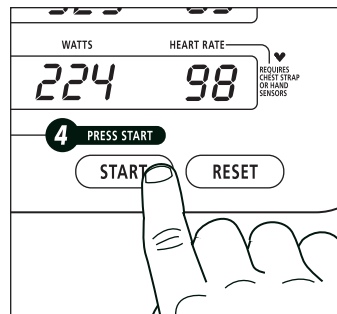

USING YOUR BIKE'S HRC PROGRAM

Use the chart on Page 16 to determine your Target Heart Rate, then follow the instructions on Page 15 to place the wireless transmitter on your chest.

Choose the Heart Rate Program by pressing the ♥ HR CONTROL button.

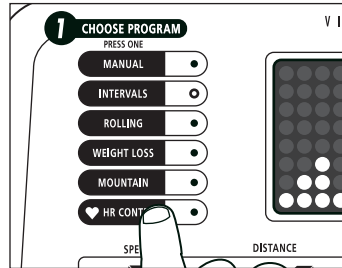

Using the Arrow buttons under 'CHOOSE LEVEL' select your Target Heart Rate, visible in the LEVEL window.

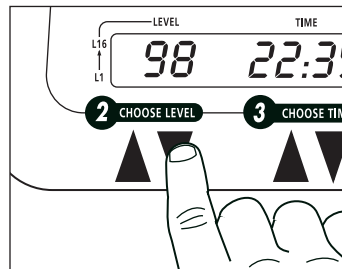

Using the Arrow buttons under 'CHOOSE TIME' select your Time, or you may use the default time of 24 Minutes.

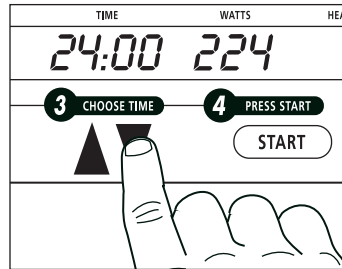

When you are ready to begin exercising press START.

The Bike will take you through a 5 minute warm-up period and then it will begin to raise the resistance until your Heart Rate is within +/-5 Beats per Minute of the Target Heart Rate you entered. Then when you have 5 minutes left in your program the Bike will begin your cool-down period and lower the resistance.

E 3 6 0 0 H R C

upright & semi-recumbent

R 2 6 0 0 H R C

ABOUT HEART RATE CONTROL

Your VISION FITNESS Bike offers two options for Heart Rate Control and Feedback; you may choose to use the convenient *Hand Contact Bars* or the hands-free *Wireless Chest Transmitter* (recommended for the Heart Rate Control Program).

CONTACT BAR HAND POSITION

Place the palm of your hands directly on the Contact Pads. Both hands must grip the bars for your Heart Rate to register.

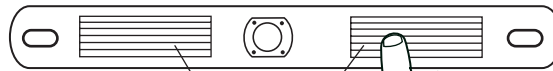
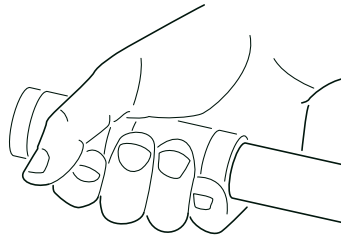

WIRELESS CHEST TRANSMITTER

Prior to wearing the Strap on your chest, moisten the two rubber contact strips with several drops of water and spread about with your fingers.

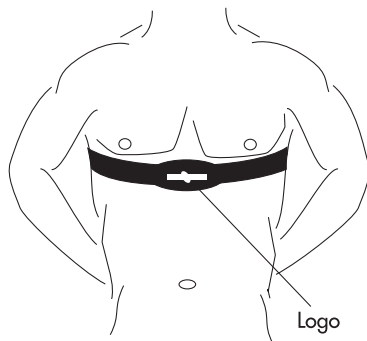
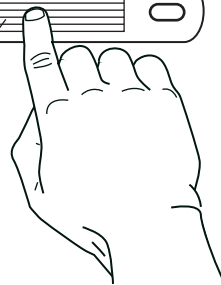

TRANSMITTER STRAP PLACEMENT

Center the Transmitter Strap just below the breast or pectoral muscles, directly over your sternum with the VISION FITNESS logo facing out.

14

E3600HRC

R2600HRC

upright & semi-recumbent

TARGET HEART RATE ZONE

Your Target Heart Rate Zone is a percentage of your maximum heart rate. Target Zone will vary for each individual, depending on age, current level of conditioning, and personal fitness goals. The American Heart Association recommends working-out at a Target Heart Rate Zone of between 60% and 75% of your maximum heart rate. See the chart below for convenient reference.

EXAMPLE for 42-year old user: find AGE along bottom of chart (round to 40), follow AGE column up to TARGET ZONE bar. RESULTS: 60% of maximum Heart Rate = 108 Beats per Minute, 75% of maximum Heart Rate = 135 Beats per Minute. With this Target Zone of 108-135 Beats per Minute it is best to enter an average Target Heart Rate of about 122 Beats per Minute into the Console.

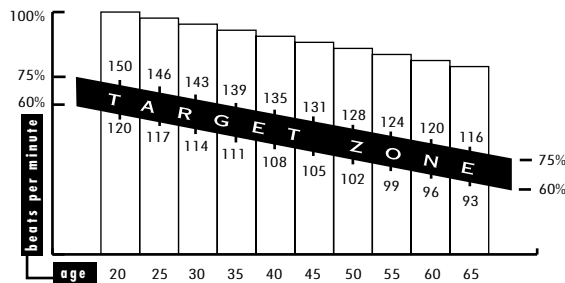

BENEFITS

- Weight Loss -- Helps you maintain an optimum exercise level to burn fat.
- Efficient -- Quantifies your exercise level for maximum benefit.
- Time Saver -- Makes the most of your limited workout time.
- Motivation -- Provides encouragement to achieve your fitness goals and reach for new heights.

15

E3600HRC

upright & semi-recumbent

R2600HRC

TROUBLESHOOTING YOUR FITNESS BIKE

Our Bikes are designed to be reliable and easy to use. If, however, you have a problem, these troubleshooting steps may indicate the cause.

PROBLEM: The Console does not light up.

SOLUTION: 1) Check to make sure the Bike is turned on (switch is located near power supply).

2) If you are using the Bike without a power supply, be sure you are *pedaling* fast enough to power the Console. If the problem persists, plug in the power supply, turn the Bike on and test to see if the Console powers up.

PROBLEM: The Bike is making a clicking noise.

SOLUTION: Using the supplied 15^{MM} wrench, remove both the right and left pedals, apply grease to the threaded portion of the pedals and reassemble the unit, making sure the pedals are as tight as possible.

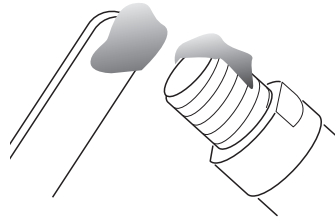

PROBLEM: The Bike appears to work but there is no resistance change.

SOLUTION: The magnetic brake assembly is not working properly; please contact your retailer.

PROBLEM: The Bike makes a squeaking or creaking noise.

SOLUTION: Check and tighten all the bolts on the Bike again.

NOTE: If the above steps do not remedy the problem, discontinue use, turn the power off and contact your retailer.

TROUBLESHOOTING YOUR HEART RATE MONITOR CHEST STRAP

PROBLEM: No pulse reading appears

SOLUTION: There may be a poor connection between the contact pads and skin. Remoisten the electrodes.

SOLUTION: Transmitter is not properly positioned. Reposition the chest strap.

SOLUTION: Verify that the distance between transmitter and receiver is not beyond the recommended range of 36 inches.

PROBLEM: There is an erratic pulse rate.

SOLUTION: Chest strap is too loose; readjust according to directions.

NOTE: It is possible that heart rate monitors will not function properly on some people due to a variety of reasons. It may be necessary to experiment with the fit and position of the chest strap. Outside interference sources such as computers, motors, etc. are also a major source of problems for heart rate monitors.

E3600HRC

upright & semi-recumbent

R2600HRC

COMMON BIKE QUESTIONS

Q: Are the sounds my Bike makes normal?

A: Our Bikes are some of the quietest available because they use belt drives and magnetic resistance. We use the highest grade European bearings and top quality belts to minimize noise. However, because the resistance system itself is so quiet, you will occasionally hear some slight mechanical noises from the drive train. Unlike older, louder technologies, there are no fans, friction belts, or alternator noises to mask these sounds on our Bikes. These mechanical noises, which may or may not be intermittent, are normal and are caused by the transfer of significant amounts of energy to a rapidly spinning flywheel. All bearings, belts and other rotating parts will generate some noise which will transmit through the casing and frame. It is also normal for these sounds to change slightly during a workout, and over time, because of thermal expansion of the parts. Keep in mind that while you work out you're sometimes exerting the equivalent mechanical energy of a washing machine or dryer!

Q: Why is the Bike I had delivered louder than the one at the store?

A: All fitness products seem quieter in a large store showroom because there is generally more background noise than in your home. Also, there will be less reverberation on a carpeted concrete floor than on a wood overlay floor. Sometimes a heavy rubber mat will help reduce reverberation through the floor. And finally, if a fitness product is placed close to a wall, there will be more reflected noise.

Q: When should I be worried about a noise?

A: As long as the sounds your Bike makes are no louder than a normal conversational tone of voice, it is considered normal noise. If your Bike is louder than this, you may want to call your service technician. Sometimes an initial diagnosis can be made over the phone.

E 3 6 0 0 H R C

R 2 6 0 0 H R C

upright & semi-recumbent

Q: What kind of routine maintenance is required?

A: We use sealed bearings throughout our Bikes so lubrication is not needed. The most important maintenance step is to simply wipe your perspiration off the Bike after each use.

Q: Will the magnets wear out over time?

A: No, we use permanent magnets that will retain their braking force indefinitely in this application. One of the big advantages of a magnetic brake is its long life since there is no physical contact between the flywheel and the magnet surface.

Q: How long will the drive belt last?

A: The computer modeling we had done indicated virtually thousands of maintenance-free hours. These belts are now used in far more demanding applications such as motorcycle drives.

E 3 6 0 0 H R C

upright & semi-recumbent

R 2 6 0 0 H R C

LIMITED HOME USE WARRANTY

VISION FITNESS extends the following exclusive, limited warranty, which shall apply only to the use of the device in the home, for residential, non-commercial purposes only. Any other use of the device shall void this warranty.

VISION FITNESS hereby extends the following limited warranties for the following components of the device, for the time period indicated:

FRAME - LIFETIME VISION FITNESS warrants the Frame against defects in workmanship and materials for the life of the product, so long as it remains in the possession of the original owner.

ECB-PLUS™ BRAKE - LIFETIME VISION FITNESS warrants the ECB-PLUS™ Magnetic Brake against defects in workmanship and materials for the life of the product, so long as it remains in the possession of the original owner. Only the Brake and Magnet assembly, and no other ancillary components or parts, are covered by this lifetime warranty

ELECTRONICS & PARTS - THREE YEARS VISION FITNESS warrants the Electronic components and all original Parts (other than the ECB-PLUS™ Magnetic Brake) against defects in workmanship and materials for a period of three years from the date of original purchase, so long as the device remains in the possession of the original owner.

LABOR - TWO YEARS VISION FITNESS shall cover the Labor cost for the repair of the device for a period of two years from the date of original purchase, so long as the device remains in the possession of the original owner.

LIMITED HOME USE WARRANTY (continued)

EXCLUSIVE REMEDY

The exclusive remedy for any of the above warranties shall be repair or replacement of defective Parts, or the supply of Labor to cure any defect, provided that Labor shall be limited to two years. All Labor shall be supplied by the local Retailer and the product must be located within that Retailer's service area. Products located outside the Retailer's service area will not be covered by the Labor warranty.

EXCLUSIONS AND LIMITATIONS

This warranty applies only to the original owner and is not transferable. This warranty is expressly limited to the repair or replacement of a defective Frame, ECB-PLUS™ Magnetic Brake, Electronic component, or defective Part and is the sole remedy of the warranty. The warranty does not cover normal wear and tear, improper assembly or maintenance, or installation of parts or accessories not originally intended or compatible with the Fitness Product as sold. The warranty does not apply to damage or failure due to accident, abuse, corrosion, discoloration of paint or plastic, or neglect. VISION FITNESS shall not be responsible for incidental or consequential damages. Parts and Electronic components reconditioned to As New Condition by VISION FITNESS or its vendors may sometimes be supplied as warranty replacement parts and constitute fulfillment of warranty terms. Any warranty replacement parts shall be warranted for the remainder of the original warranty term.

VISION FITNESS expressly disclaims all other warranties, express or implied, including but not limited to all warranties of fitness for a particular purpose or of merchantability. This warranty gives you specific legal rights and your rights may vary from state to state.

WARRANTY REGISTRATION

Your warranty card must be completed and sent to VISION FITNESS before a warranty claim can be processed. You may also register via our website at www.visionfitness.com. Inside the enclosed warranty card you will find a customer survey. Your care in completing the survey will be of value to us in serving you in the future. Comments and suggestions are always welcome. We are certain you will enjoy your new Fitness Bike. Thank you for selecting a VISION FITNESS product.

E 3 6 0 0 H R C

upright & semi-recumbent

R 2 6 0 0 H R C

LIMITED LIGHT COMMERCIAL WARRANTY

Up to 5 hours use per day

LIGHT COMMERCIAL USES DEFINED VISION FITNESS warrants models E3600HRC & R2600HRC for use in light commercial facilities including: Hotels, Resorts, Police & Fire Stations, Apartment Complexes, Corporate Fitness Centers, Hospitals, Rehabilitation and Sports Medicine Clinics, where average use is up to five hours per day. Not warranted for private Health Clubs, YMCA's or Schools.

FRAME, ECB-PLUS™ BRAKE, ELECTRONICS & PARTS - TWO YEARS VISION FITNESS warrants the Frame, ECB-PLUS™ Magnetic Brake, Electronic components and all original Parts against defects in workmanship and materials for a period of two years from the date of original purchase, so long as the device remains in the possession of the original owner.

LABOR - TWO YEARS VISION FITNESS shall cover the Labor cost for the repair of the device for a period of two years from the date of original purchase, so long as the device remains in the possession of the original owner.

EXCLUSIVE REMEDY

The exclusive remedy for any of the above warranties shall be repair or replacement of defective Parts, or the supply of Labor to cure any defect, provided that Labor shall be limited to two years. All Labor shall be supplied by the local Retailer and the product must be located within that Retailer's service area. Products located outside the Retailer's service area will not be covered by the Labor warranty.

E 3 6 0 0 H R C

R 2 6 0 0 H R C

upright & semi-recumbent

LIMITED LIGHT COMMERCIAL WARRANTY (continued)

Up to 5 hours use per day

EXCLUSIONS AND LIMITATIONS

This warranty applies only to the original owner and is not transferable. This warranty is expressly limited to the repair or replacement of a defective Frame, ECB-PLUS™ Magnetic Brake, Electronic component, or defective Part and is the sole remedy of the warranty. The warranty does not cover normal wear and tear, improper assembly or maintenance, or installation of parts or accessories not originally intended or compatible with the Fitness Product as sold. The warranty does not apply to damage or failure due to accident, abuse, corrosion, discoloration of paint or plastic, or neglect. VISION FITNESS shall not be responsible for incidental or consequential damages. Parts and Electronic components reconditioned to As New Condition by VISION FITNESS or its vendors may sometimes be supplied as warranty replacement parts and constitute fulfillment of warranty terms. Any warranty replacement parts shall be warranted for the remainder of the original warranty term.

VISION FITNESS expressly disclaims all other warranties, express or implied, including but not limited to all warranties of fitness for a particular purpose or of merchantability. This warranty gives you specific legal rights and your rights may vary from state to state.

WARRANTY REGISTRATION

Your warranty card must be completed and sent to VISION FITNESS before a warranty claim can be processed. You may also register via our website at www.visionfitness.com. Inside the enclosed warranty card you will find a customer survey. Your care in completing the survey will be of value to us in serving you in the future. Comments and suggestions are always welcome. We are certain you will enjoy your new Fitness Bike. Thank you for selecting a VISION FITNESS product.

E 3 6 0 0 H R C

upright & semi-recumbent

R 2 6 0 0 H R C

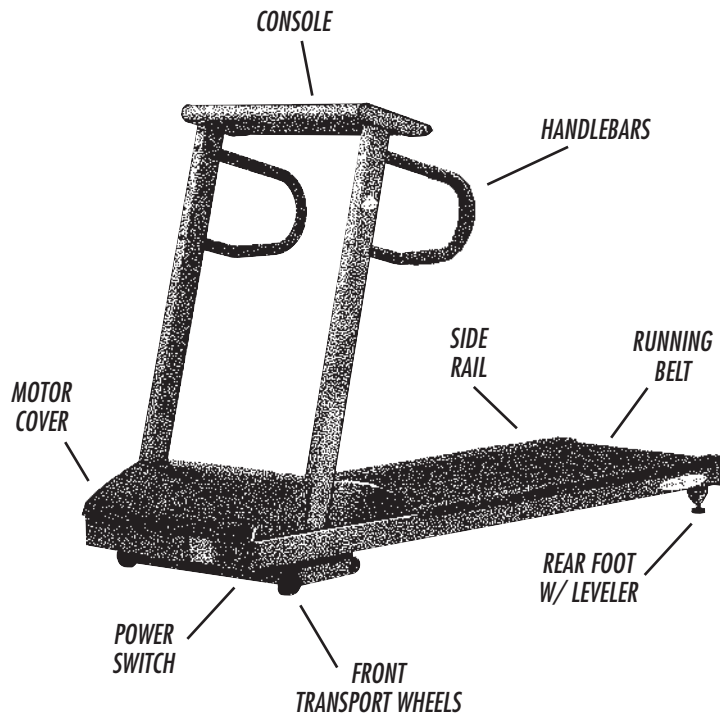

IMPORTANT SAFETY INSTRUCTIONS SAVE THESE INSTRUCTIONS

When using an electrical product, basic precautions should always be followed, including the following:

Read all instructions before using this VISION FITNESS Treadmill.

WARNING! Connect this exercise product to a properly grounded outlet only. See grounding instructions.

GROUNDING INSTRUCTIONS

This exercise product must be grounded. If it should malfunction or breakdown, grounding provides a path of least resistance for electrical current to reduce the risk of electrical shock. This product is equipped with a cord having an equipment-grounding conductor and a grounding plug. The plug must be plugged into an appropriate outlet that is properly installed and grounded in accordance with local codes and ordinances.

DANGER! Improper connection of the equipment-grounding conductor can result in a risk of electric shock. Check with a qualified electrician or service-person if you are in doubt as to whether the product is properly grounded. Do not modify the plug provided with the product; if it will not fit the outlet, have a proper outlet installed by a qualified electrician.

This product is for use on a nominal 120-volt circuit, and has a grounding plug that looks like the plug illustrated below. A temporary adapter such as the one illustrated below may be used to connect this plug to a 2-pole receptacle as shown, if a properly grounded outlet is not available. The temporary adapter should be used only until a properly grounded outlet can be installed by a qualified electrician. The green colored rigid ear, lug, or the like extending from the adapter must be connected to a permanent ground such as a properly grounded outlet box cover. Whenever the adapter is used, it must be held in place by a metal screw.

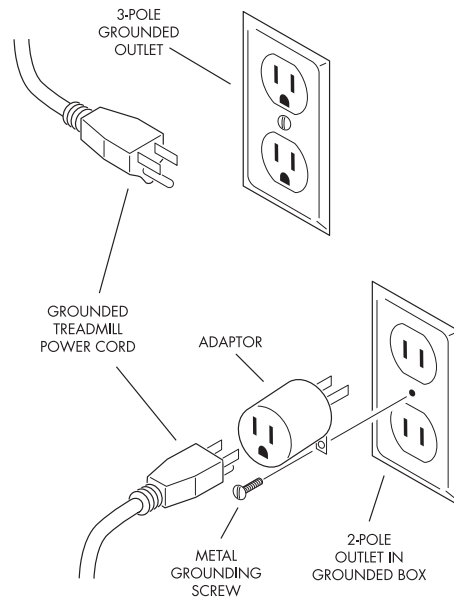

WARNING! To reduce the risk of burns, fire, electrical shock or injury to persons:

- Use this exercise product for its intended use as described in this Owner's Guide. Do not use attachments not recommended by the manufacturer.
- Never drop or insert any object into any opening.
- Do not remove the Treadmill motor covers or roller covers. Service should be performed only by an authorized VISION FITNESS retailer.
- Never operate this Treadmill if it has a damaged cord or plug, if it is not working properly, if it has been damaged, or immersed in water. Return the Treadmill to a retailer for examination and repair.
- Keep the cord away from heated surfaces.
- Do not use outdoors.
- To disconnect, turn the switch to the OFF position, then remove plug from outlet.
- Only use the power cord provided with your VISION FITNESS Treadmill.
- Never place the power cord under carpeting or place any object on top of the power cord, which may pinch and damage it.
- Unplug your VISION FITNESS Treadmill before moving it.

CHILDREN

- Keep children off your VISION FITNESS Treadmill at all times.
- When the VISION FITNESS Treadmill is in use, young children and pets should be kept at least 10 feet away.

OTHER SAFETY TIPS FOR YOUR VISION FITNESS TREADMILL

CAUTION! If you experience chest pains, nausea, dizziness or shortness of breath, stop exercising immediately and consult your physician before continuing.

- Do not wear clothing that might catch on any part of the Treadmill.
- Read this Owner's Guide before operating this Treadmill.

CLEANING

- Clean with soap and slightly damp cloth only; never use solvents.

MOVING

Your VISION FITNESS Treadmill has a pair of transport wheels built into the front legs. To move, firmly grasp the back end of the frame, carefully lift and roll.

CAUTION: Our Treadmills are well-built and heavy, weighing up to 325 lbs.! Use care and additional help if necessary.

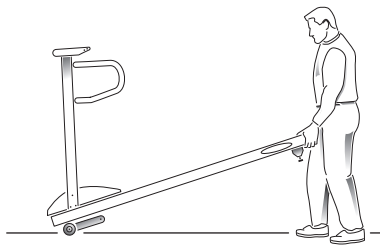

LEVELING

The Treadmill should be level for optimum use. Once you have placed the Treadmill where you intend to use it, raise or lower one or both of the adjustable levelers located on the back of the Treadmill frame. A carpenter's level is recommended. If your Treadmill is not level, the running belt may not track properly. Once you have leveled the Treadmill, lock the levelers in place by tightening the nuts against the frame.

GETTING STARTED

POWER

Ensure that your Treadmill is properly connected to a power outlet, then turn on the Power switch, located at the front of the main frame.

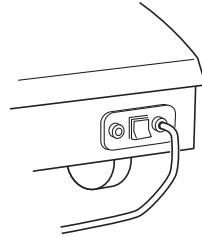

EMERGENCY STOP

If at any time you need to stop the Treadmill quickly, simply press the red Emergency Stop button. This will instantly cut all power and the Treadmill will come to a stop.

To resume your workout, you will need to re-enter any Program data.



T8600S ONE-BUTTON START™

Simply press the Start button to begin exercising.

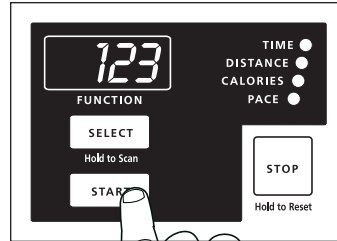

PAUSE

Press the Stop button to pause during your workout.

RESET

Press and hold the Stop button to reset the treadmill.



FEEDBACK DISPLAY

ELEVATION

Shown as percentage of incline, Elevation is visible in the left-hand LED window. Indicates how steeply inclined the running surface is, to simulate running on a hill.

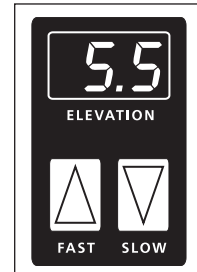

SPEED

Shown as Miles per Hour, Speed is visible in the right-hand LED window. Indicates how fast the running surface is moving, to simulate outdoor running

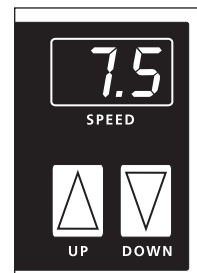

FEEDBACK DISPLAY

SCAN FUNCTION

To scan through the functions during your workout, simply press the Select button. To continuously Scan, press and hold until the Console double-beeps (about 2 seconds).

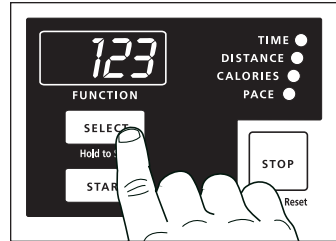

TIME

Shown as Minutes:Seconds. View the Time remaining or the Time elapsed in your workout.

DISTANCE

Shown as Miles. View Distance traveled during workout.

CALORIES

Shown as total accumulated Calories burned during workout.

PACE

Shown as Time (Minutes:Seconds) required to travel 1 mile at current Speed.

T8600HRC ONE-BUTTON START™

Simply press the Start button to begin exercising in the MANUAL Program.

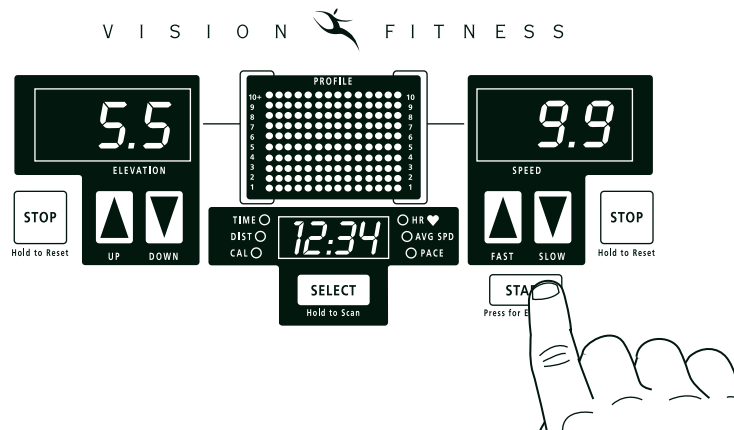

PAUSE

Press the STOP button to pause during your workout

RESET

Press and hold the STOP button to reset the Treadmill.

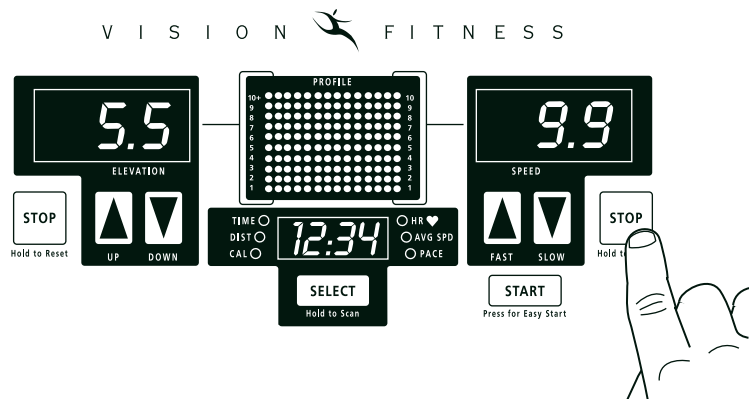

PROGRAM DETAILS

P1 - MANUAL

Customized workouts; with no default Time.



P2 - INTERVALS

Improves your strength, speed, and endurance by raising and lowering the resistance Level throughout your workout to involve both your heart and muscles; Time defaults to 24 minutes.

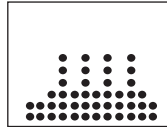

P3 - WEIGHT LOSS • SPEED CHANGES

Promotes weight loss by raising and lowering your speed level while still keeping you within your fat burning zone; Time defaults to 48 minutes.

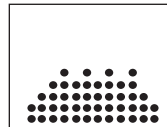

P4 - WEIGHT LOSS • ELEVATION CHANGES

Promotes weight loss by raising and lowering your elevation level while still keeping you within your fat burning zone; Time defaults to 48 minutes.



P5 - 5K RUN

Improves your cardiovascular training by simulating a 5K run with hills; no preset time with elevation changes.



P6 - 10K RUN

Improves your endurance training by simulating a 10K run with hills; no preset time with elevation changes.

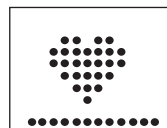

P7 - HEART RATE CONTROL

Saves time by making the most of your limited workout time; motivates and encourages you to achieve your fitness goals. Benefits weight loss by maintaining an optimum exercise level to burn fat; Time defaults to 24 minutes.

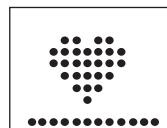

NOTE: All the programs can provide an aerobic and cardiovascular benefit in addition to the specific benefits listed.

FEEDBACK DISPLAY

SCAN FUNCTION

To scan through the functions during your workout, simply press the Select button. To continuously Scan, press and hold until the Console double-beeps (about 2 seconds).

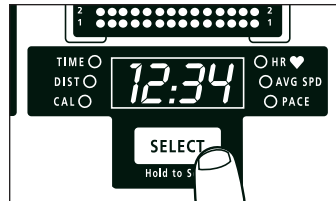

AVERAGE SPEED

Shown as Miles per Hour. Equals accumulated Distance ÷ elapsed Time. Corresponds to simulated outdoor walking or running Speed.

DISTANCE

Shown as Miles. View Distance traveled during workout.

CALORIES

Shown as total accumulated Calories burned during workout.

PACE

Shown as Time (Minutes:Seconds) required to travel 1 mile at current Speed.

TIME

Shown as Minutes:Seconds. View the Time remaining or the Time elapsed in your workout.

HEART RATE

Shown as Beats per Minute. You can monitor your Heart Rate at any time during a workout.

FEEDBACK DISPLAY

ELEVATION

Shown as percentage of incline, Elevation is visible in the left-hand LED window. Indicates how steeply inclined the running surface is, to simulate running on a hill.

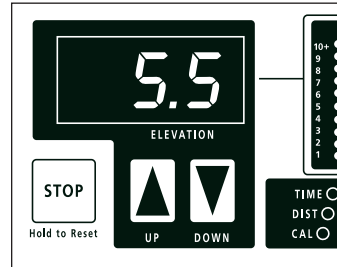

SPEED

Shown as Miles/Hour, Speed is visible in the right-hand LED window. Indicates how fast the running surface is moving, to simulate outdoor running

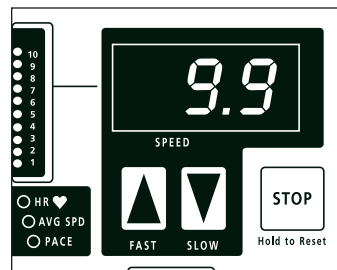

PROFILE

Shown as a graphical representation of the Program you have chosen (Intervals, Weight Loss, etc.). The left-most column of orange LEDs indicates Elevation and corresponds to the main Elevation window. The right-most column of green LEDs indicates Speed and corresponds to the main Speed window.

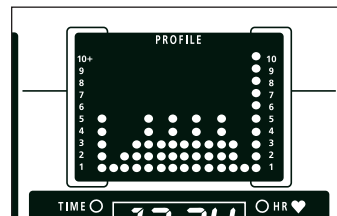

CHOOSING A PROGRAM

Use the Arrow buttons to choose one of the 7 Programs (P1 - MANUAL, P2 - INTERVALS, etc.). Press SELECT.

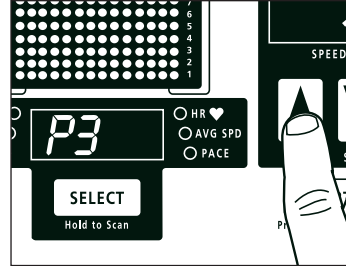

CHOOSING A LEVEL

Use the Arrow buttons to choose one of the 9 Levels; L1 provides the least resistance, L9 the most. Press SELECT.

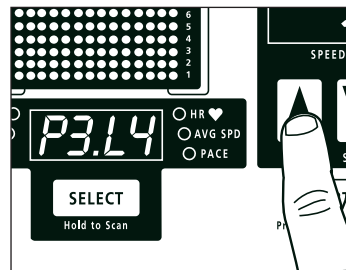

CHOOSING A TIME

After you have chosen a Level, the Time will default, depending on which Program you have chosen, and then flash. You may use this default Time or choose another by using either set of Arrow buttons.

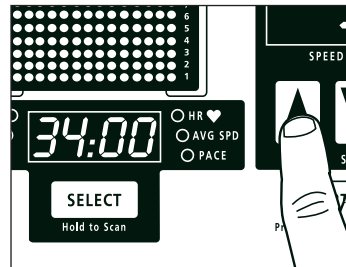

When you are ready to begin exercising press START.

FINISHING

When your work-out is complete the Speed window will beep and flash three times letting you know that your Program is complete. The Treadmill will return to its starting position and you will be able to use the Select button to scan through and check your DISTANCE, CALORIES, AVERAGE SPEED and PACE.

USING YOUR TREADMILL'S HRC PROGRAM

Use the chart on Page 43 to determine your Target Heart Rate, then follow the instructions on Page 42 to place the wireless transmitter on your chest.

CHOOSING THE HEART RATE PROGRAM

Using either set of Arrow buttons, select 'P7' Heart Rate Program and press SELECT.

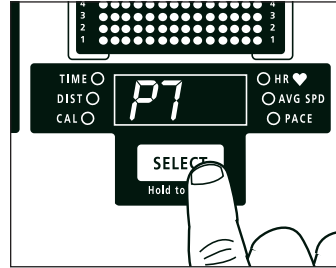

ENTERING TARGET HEART RATE

Using the Arrow buttons, enter your Target Heart Rate and press SELECT.

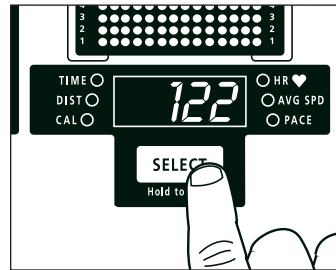

CHOOSING A WORKOUT TIME

The Time will default to 34 minutes, or you may use either set of Arrow buttons to choose another Time (how long you wish to workout). Press SELECT.

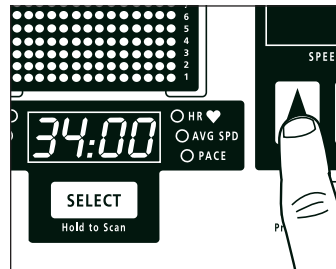

When you are ready to begin exercising press START.

NOTE: You must choose a workout Time of at least 15 Minutes. The Treadmill will take you through a 5-minute warm-up period and then it will begin to raise the elevation of the Treadmill until your Heart Rate is within +/- 5 Beats per Minute of the Target Heart Rate you entered. Finally, when you have 5 minutes left in your program, the Treadmill will begin your cool-down period and lower the elevation. No matter how long your workout, there is always a 5-minute warm-up and 5-minute cool-down.

HEART RATE CONTROL

Your VISION FITNESS Treadmill offers Heart Rate Control and Feedback.

WIRELESS CHEST TRANSMITTER

Prior to wearing the Strap on your chest, moisten the two rubber contact strips with several drops of water and spread about with your fingers.

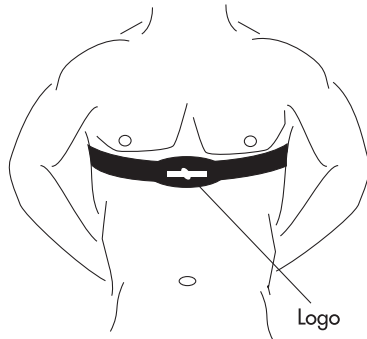
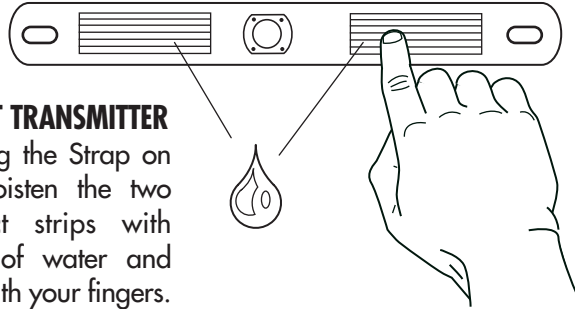

TRANSMITTER STRAP PLACEMENT

Center the Transmitter Strap just below the breast or pectoral muscles, directly over your sternum with the VISION FITNESS logo facing out.

TARGET HEART RATE ZONE

Your Target Heart Rate Zone is a percentage of your maximum heart rate. Target Zone will vary for each individual, depending on age, current level of conditioning, and personal fitness goals. The American Heart Association recommends working-out at a Target Heart Rate Zone of between 60% and 75% of your maximum heart rate. See the chart below for convenient reference.

EXAMPLE for 42-year old user: find AGE along bottom of chart (round to 40), follow AGE column up to TARGET ZONE bar. RESULTS: 60% of maximum Heart Rate = 108 Beats per Minute, 75% of maximum Heart Rate = 135 Beats per Minute. With this Target Zone of 108-135 Beats per Minute it is best to enter an average Target Heart Rate of about 122 Beats per Minute into the Console.

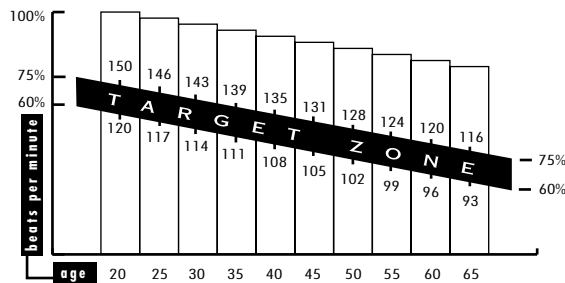

BENEFITS

- Weight Loss -- Helps you maintain an optimum exercise level to burn fat.
- Efficient -- Quantifies your exercise level for maximum benefit.
- Time Saver -- Makes the most of your limited workout time.
- Motivation -- Provides encouragement to achieve your fitness goals, and reach for new heights.

TROUBLESHOOTING YOUR TREADMILL

Our Treadmills are designed to be reliable and easy to use. If, however, you have a problem, these troubleshooting steps may indicate the cause.

PROBLEM: The Console does not light up.

SOLUTION: Check to make sure the Treadmill is connected to a functioning outlet, and that the Treadmill is turned on.

PROBLEM: The Treadmill's built-in circuit breaker trips repeatedly, shutting-off for no apparent reason.

SOLUTION: The lubricating wax coating on the deck is wearing down and needs to be replenished; contact your VISION FITNESS retailer.

PROBLEM: The Treadmill shuts off when elevated.

SOLUTION: Check to make sure that the power cord is not stretched so tight that when the Treadmill is elevated the cord is pulled out of the wall outlet.

PROBLEM: The running belt does not stay in the center of the Treadmill when you are running on it.

SOLUTION: 1) Check to make sure the Treadmill is level.
2) The running belt is loose and needs to be properly tensioned (see Page 47 for proper procedure).

PROBLEM: The belt moves within 1/4" of -- but does not touch -- the side rail.

SOLUTION: There is nothing wrong, this is normal and will not cause any damage.

NOTE: If the above steps do not remedy the problem, discontinue use, turn the power off and contact your VISION FITNESS retailer.

TROUBLESHOOTING YOUR HEART RATE MONITOR CHEST STRAP

PROBLEM: No pulse reading appears

SOLUTION: There may be a poor connection between the contact pads and skin. Remoisten electrodes.

SOLUTION: Transmitter is not properly positioned. Reposition the chest strap.

SOLUTION: Verify that the distance between transmitter and receiver is not beyond the recommended range of 36 inches.

PROBLEM: There is an erratic pulse rate.

SOLUTION: Chest strap is too loose; readjust according to directions.

NOTE: It is possible that heart rate monitors will not function properly on some people due to a variety of reasons. It may be necessary to experiment with the fit and position of the chest strap. Outside interference sources such as computers, motors, etc. are also a major source of problems for heart rate monitors.

COMMON TREADMILL QUESTIONS

Q: Are the sounds my Treadmill makes normal?

A: All Treadmills make a certain type of thumping noise due to the belt riding over the rollers. This noise will diminish over time, although it might not totally go away. Over time, the belt will stretch, causing the belt to ride smoother over the rollers. It might also appear that one Treadmill is louder than the other due to this thumping, but that is due to the difference in belt tension.

Q: Why is the Treadmill I had delivered louder than the one at the store?

A: All fitness products seem quieter in a large store showroom because there is generally more background noise than in your home. Also, there will be less reverberation on a carpeted concrete floor than on a wood overlay floor. Sometimes a heavy rubber mat will help reduce reverberation through the floor. And finally, if a fitness product is placed close to a wall, there will more reflected noise.

Q: When should I be worried about a noise?

A: As long as the sounds your Treadmill makes are no louder than a normal conversational tone of voice, it is considered normal noise. If your Treadmill is louder than this, you may want to call your service technician. Sometimes an initial diagnosis can be made over the phone.

TENSIONING THE BELT

If the running belt slips when used, use the supplied 8^{MM} Allen wrench to turn the left and right tension bolts clockwise 1/4-turn at a time until the belt no longer slips.

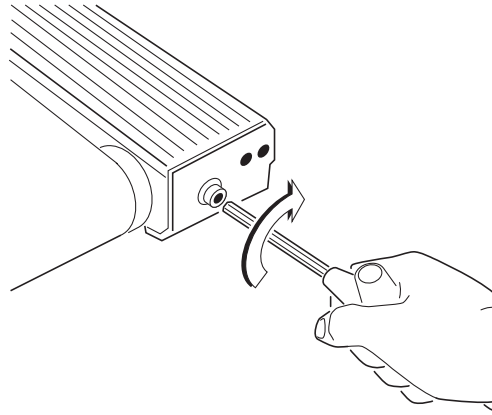

CENTERING THE BELT

If the running belt is too far to the *right* side, use the supplied 8^{MM} Allen wrench to turn the *right* tension bolt *clockwise* 1/4-turn at a time until the belt remains centered during use.

If the running belt is too far to the *left* side, turn the *left* tension bolt clockwise 1/4-turn at a time until the belt remains centered during use.

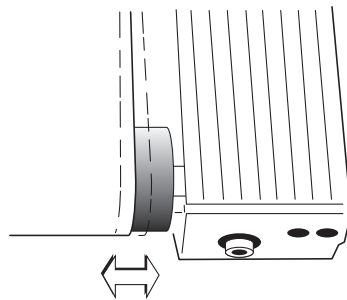

LIMITED HOME USE WARRANTY

VISION FITNESS extends the following exclusive, limited warranty, which shall apply only to the use of the device in the home, for residential, non-commercial purposes only. Any other use of the device shall void this warranty.

VISION FITNESS hereby extends the following limited warranties for the following components of the device, for the time period indicated:

FRAME - LIFETIME VISION FITNESS warrants the Frame against defects in workmanship and materials for the life of the product, so long as it remains in the possession of the original owner.

MOTOR - FIVE YEARS VISION FITNESS warrants the Motor against defects in workmanship and materials for a period of five years from the date of original purchase, so long as the device remains in the possession of the original owner.

ELECTRONICS & PARTS - TWO YEARS VISION FITNESS warrants the Electronic components and all original Parts (other than the Motor) against defects in workmanship and materials for a period of two years from the date of original purchase, so long as the device remains in the possession of the original owner.

LABOR - TWO YEARS VISION FITNESS shall cover the Labor cost for the repair of the device for a period of two years from the date of original purchase, so long as the device remains in the possession of the original owner.

LIMITED HOME USE WARRANTY (continued)

EXCLUSIVE REMEDY

The exclusive remedy for any of the above warranties shall be repair or replacement of defective Parts, or the supply of Labor to cure any defect, provided that Labor shall be limited to two years. All Labor shall be supplied by the local Retailer and the product must be located within that Retailer's service area. Products located outside the Retailer's service area will not be covered by the Labor warranty.

EXCLUSIONS AND LIMITATIONS

This warranty applies only to the original owner and is not transferable. This warranty is expressly limited to the repair or replacement of a defective Frame, Electronic component, or defective Part and is the sole remedy of the warranty. The warranty does not cover normal wear and tear, improper assembly or maintenance, or installation of parts or accessories not originally intended or compatible with the Fitness Product as sold. The warranty does not apply to damage or failure due to accident, abuse, corrosion, discoloration of paint or plastic, or neglect. VISION FITNESS shall not be responsible for incidental or consequential damages. Parts and Electronic components reconditioned to As New Condition by VISION FITNESS or its vendors may sometimes be supplied as warranty replacement parts and constitute fulfillment of warranty terms. Any warranty replacement parts shall be warranted for the remainder of the original warranty term.

VISION FITNESS expressly disclaims all other warranties, express or implied, including but not limited to all warranties of fitness for a particular purpose or of merchantability. This warranty gives you specific legal rights and your rights may vary from state to state.

WARRANTY REGISTRATION

Your warranty card must be completed and sent to VISION FITNESS before a warranty claim can be processed. You may also register via our website at www.visionfitness.com. Inside the enclosed warranty card you will find a customer survey. Your care in completing the survey will be of value to us in serving you in the future. Comments and suggestions are always welcome. We are certain you will enjoy your new Treadmill. Thank you for selecting a VISION FITNESS product.

LIMITED LIGHT COMMERCIAL WARRANTY

Up to 5 hours use per day

LIGHT COMMERCIAL USES DEFINED VISION FITNESS warrants models T8600S & T8600HRC for use in light commercial facilities including: Hotels, Resorts, Police & Fire Stations, Apartment Complexes, Corporate Fitness Centers, Hospitals, Rehabilitation and Sports Medicine Clinics, where average use is up to five hours per day. Not warranted for private Health Clubs, YMCA's or Schools.

FRAME, MOTOR, ELECTRONICS, PARTS - TWO YEARS VISION FITNESS warrants the Frame, Motor, Electronic components and all original Parts against defects in workmanship and materials for a period of two years from the date of original purchase.

LABOR - TWO YEARS VISION FITNESS warrants the Labor used in the repair of the device for a period of two years from the date of original purchase, so long as the device remains in the possession of the original owner.

EXCLUSIVE REMEDY

The exclusive remedy for any of the above warranties shall be repair or replacement of defective Parts, or the supply of Labor to cure any defect, provided that Labor shall be limited to two years. All Labor shall be supplied by the local Retailer and the product must be located within that Retailer's service area. Products located outside the Retailer's service area will not be covered by the Labor warranty.

LIMITED LIGHT COMMERCIAL WARRANTY (continued)

Up to 5 hours use per day

EXCLUSIONS AND LIMITATIONS

This warranty applies only to the original owner and is not transferable. This warranty is expressly limited to the repair or replacement of a defective Frame, Electronic component, or defective Part and is the sole remedy of the warranty. The warranty does not cover normal wear and tear, improper assembly or maintenance, or installation of parts or accessories not originally intended or compatible with the Fitness Product as sold. The warranty does not apply to damage or failure due to accident, abuse, corrosion, discoloration of paint or plastic, or neglect. VISION FITNESS shall not be responsible for incidental or consequential damages. Parts and Electronic components reconditioned to As New Condition by VISION FITNESS or its vendors may sometimes be supplied as warranty replacement parts and constitute fulfillment of warranty terms. Any warranty replacement parts shall be warranted for the remainder of the original warranty term.

VISION FITNESS expressly disclaims all other warranties, express or implied, including but not limited to all warranties of fitness for a particular purpose or of merchantability. This warranty gives you specific legal rights and your rights may vary from state to state.

WARRANTY REGISTRATION

Your warranty card must be completed and sent to VISION FITNESS before a warranty claim can be processed. You may also register via our website at www.visionfitness.com. Inside the enclosed warranty card you will find a customer survey. Your care in completing the survey will be of value to us in serving you in the future. Comments and suggestions are always welcome. We are certain you will enjoy your new Treadmill. Thank you for selecting a VISION FITNESS product.

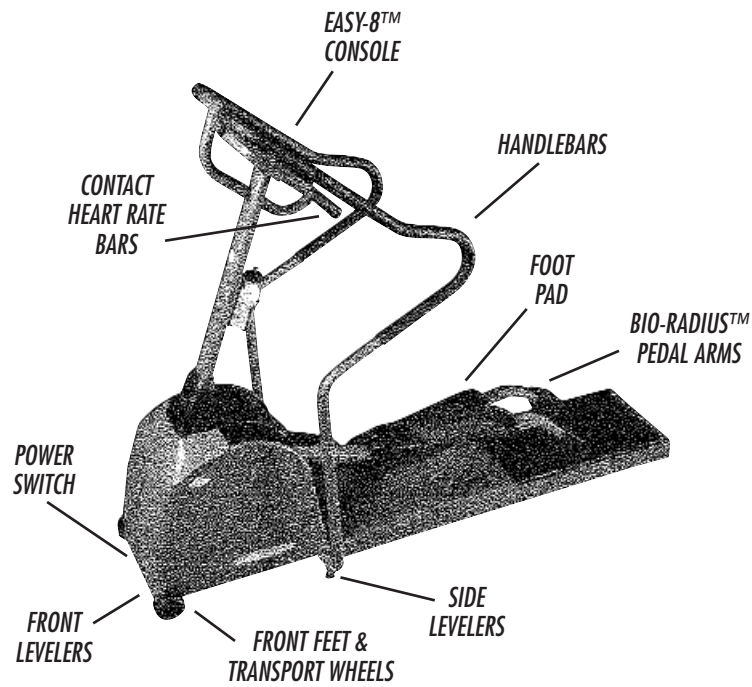

elliptical trainers **X6600HRC&DA**

IMPORTANT SAFETY INSTRUCTIONS SAVE THESE INSTRUCTIONS

When using an electrical product, basic precautions should always be followed, including the following:

Read all instructions before using this exercise product.

Your VISION FITNESS Elliptical Trainer is self-generating (requiring no external power source) and in this mode must be pedaled to power-up the console. Alternatively, the Elliptical Trainer can also be plugged into an outlet using the included power supply.

WARNING! To reduce the risk of burns, fire, electrical shock or injury to persons:

- Use this exercise product for its intended use as described in this Owner's Guide. Do not use attachments not recommended by the manufacturer.
- Never drop or insert any object into any opening.
- Do not remove the Elliptical Trainer sidecovers. Service should be performed only by an authorized VISION FITNESS retailer.
- Never operate this Elliptical Trainer if it has a damaged cord or plug, if it is not working properly, if it has been damaged, or immersed in water. Return the Elliptical Trainer to a retailer for examination and repair.
- Keep the cord away from heated surfaces.
- Do not use outdoors.
- To disconnect, turn the switch to the OFF position, then remove plug from outlet.
- Only use the power cord provided with your VISION FITNESS Elliptical Trainer.
- Never place the power cord under carpeting or place any object on top of the power cord, which may pinch and damage it.
- Unplug your VISION FITNESS Elliptical Trainer before moving it.

CHILDREN

- Keep children off your VISION FITNESS Elliptical Trainer at all times.
- When the VISION FITNESS Elliptical Trainer is in use, young children and pets should be kept at least 10 feet away.

OTHER SAFETY TIPS FOR YOUR VISION FITNESS ELLIPTICAL TRAINER

CAUTION! If you experience chest pains, nausea, dizziness or shortness of breath, stop exercising immediately and consult your physician before continuing.

- Do not wear clothing that might catch on any part of the Elliptical Trainer.
- Read this Owner's Guide before operating this Elliptical Trainer.

CLEANING

- Clean with soap and slightly damp cloth only; never use solvents.

MOVING

Your VISION FITNESS Elliptical Trainer has a pair of transport wheels built into the front legs. To move, firmly grasp the back end of the frame, using the transport grips, carefully lift and roll.

CAUTION: Our Elliptical Trainers are well-built and heavy, weighing up to 250 lbs.! Use care and additional help if necessary.

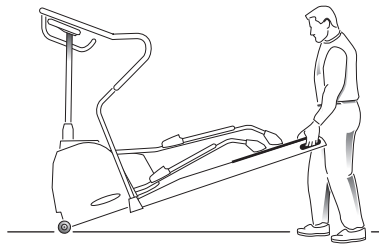

LEVELING

The Elliptical Trainer should be level for optimum use. Once you have placed the Elliptical Trainer where you intend to use it, raise or lower one or both of the adjustable levelers located on the bottom of the front legs and on the base of the Elliptical Trainer handlebars. Once you have leveled the Elliptical Trainer, lock the levelers in place by tightening the wing nuts against the frame.



ELLIPTICAL TRAINER FOOT POSITION

Your VISION FITNESS Elliptical Trainer has a large foot pad, offering you a variety of foot positions.

When using your Elliptical Trainer you may notice that your heel raises off the foot pad. This is a normal 'heel toe plant' walking or running motion and you should not try to prevent this.

STEP POSITION

Moving your foot to the forwardmost position of the foot pad increases your step height; your workout will feel similar to a step machine workout. This position is particularly effective for developing your quadricep muscles.

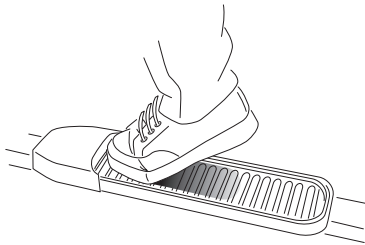

GLIDE POSITION

Placing your foot toward the back of the foot pad decreases your step height and keeps the step pattern elliptical; your workout will feel more like a ski glide, or smooth run or walk

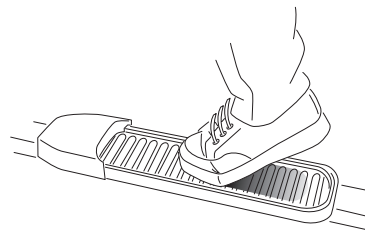

EASY-8™ CONSOLE

Your EASY-8™ Console arrives preset to display Miles. If you wish to display Kilometers instead, remove the Console from the Console Mast by removing the four mounting bolts. Inside the mounting recess you will find a small switch; move this MPH/KM Conversion Switch to the right to display Kilometers. Remount the Console to the Console Mast.

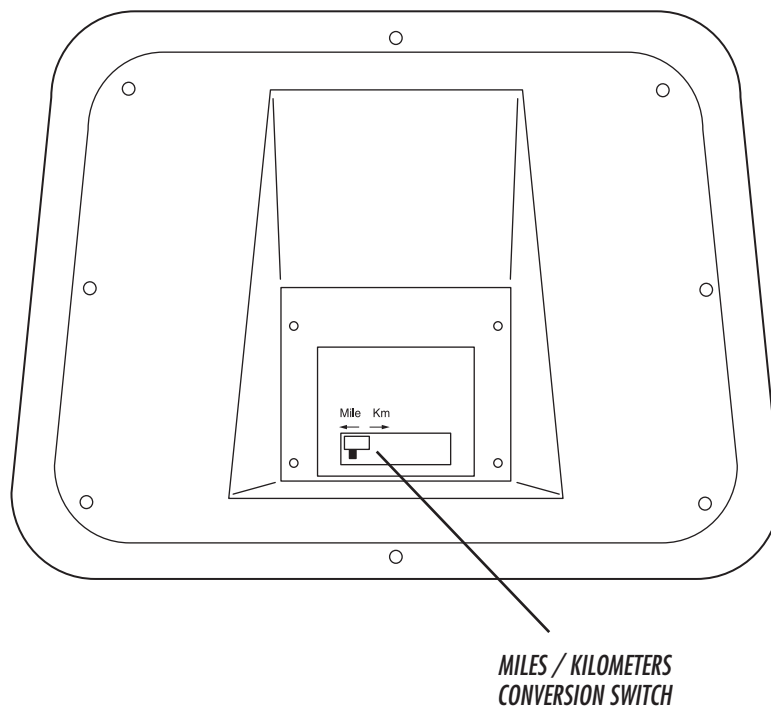

GETTING STARTED

POWER

Your Elliptical Trainer is self-generating (requiring no external power source) and in this mode must be pedaled to power-up the Console. Alternatively, the Elliptical Trainer can also be plugged into an outlet using the included power supply. If using the Elliptical Trainer in this mode, ensure that it is properly connected to the power outlet, then turn on the Power switch, located near the power supply.

ONE-BUTTON START™

Simply press the Start button to begin exercising in the MANUAL Program.

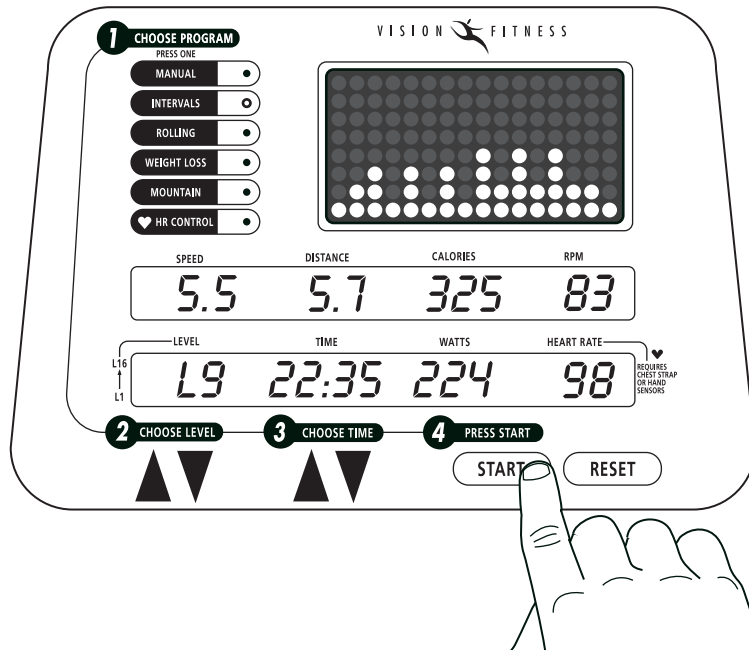

PROGRAM DETAILS

MANUAL Customized workouts; with no default Time.

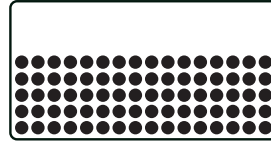

INTERVALS Improves your strength, speed, and endurance by raising and lowering the resistance Level throughout your workout to involve both your heart and muscles; Time defaults to 24 minutes.

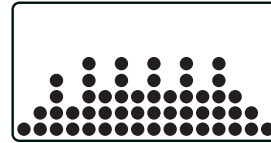

ROLLING Maintains weight by gradually raising and lowering the resistance Level to gradually raise and lower your Heart Rate; Time defaults to 32 minutes.

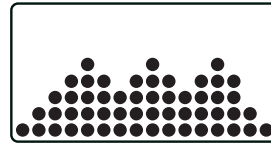

WEIGHT LOSS Promotes weight loss by raising and lowering the resistance Level, but still keeps you in your fat-burning zone; Time defaults to 48 minutes.

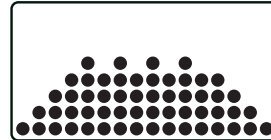

MOUNTAIN Improves performance by raising resistance Level to a high peak then lowering again; Time defaults to 48 minutes.

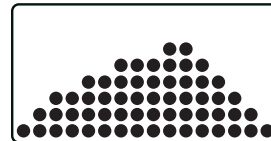

HR CONTROL Saves time by making the most of your limited workout time; motivates and encourages you to achieve your fitness goals. Benefits weight loss by maintaining an optimum exercise level to burn fat; Time defaults to 24 minutes.



NOTE: In addition to the specific benefits listed, all the Programs can provide an aerobic and cardiovascular benefit.

FEEDBACK DISPLAY



SPEED

Shown as Miles per Hour or Kilometers per Hour. View the current striding Speed.

DISTANCE

Shown as Miles or Kilometers. View Distance during workout.

CALORIES

Shown as total accumulated Calories burned during workout.

RPM

Shown as Revolutions per Minute. Improve striding technique while reducing leg muscle fatigue by striding between 60 & 70 RPMs.

FINISHING

When your work-out is complete the Display windows will begin flashing your workout information, allowing you to record it in your personal logbook. If you are using the Elliptical Trainer with the external power supply, the workout information will flash for 5 minutes.

NOTE: If you are instead using the Elliptical Trainer in the self-generating mode, your workout information will flash only as long as you continue striding.

PROGRAM LEVEL

View the current chosen Program Level. Indicates the difficulty of your workout, with L1 being the easiest and L16 being the most difficult.

TIME

Shown as Minutes:Seconds. View the Time remaining or the Time elapsed in your workout.

WATTS

A measurement of your expended energy. May be used to evaluate and quantify your fitness progress over time.

HEART RATE

Shown as Beats per Minute. You can monitor your Heart Rate at any time during a workout.

CHOOSING A PROGRAM

If you do not choose a Program, the EASY-8™ Console will default to the MANUAL Program. If you wish to choose another Program, simply press one of the other Program buttons.

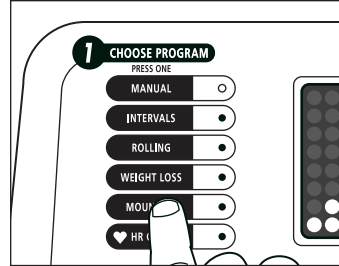

CHOOSING A LEVEL

After you have chosen a Program, the Level will default to L6 and then flash. You may use this default Level or choose another by using the Arrow buttons; L1 provides the least resistance, L16 the most.

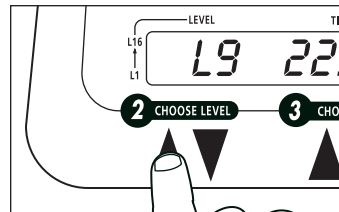

CHOOSING A TIME

After you have chosen a Level, the Time will default, depending on which Program you have chosen, and then flash. You may use this default Time or choose another by using the Arrow buttons.

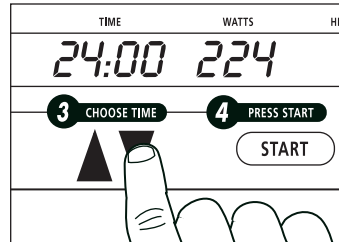

STARTING

When you are ready to begin exercising press START.

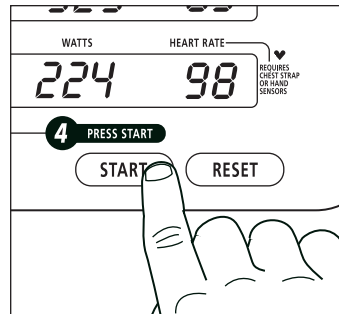

USING YOUR ELLIPTICAL TRAINER'S HRC PROGRAM

Use the chart on Page 65 to determine your Target Heart Rate, then follow the instructions on Page 64 to place the wireless transmitter on your chest.

Choose the Heart Rate Program by pressing the ♥ HR CONTROL button.

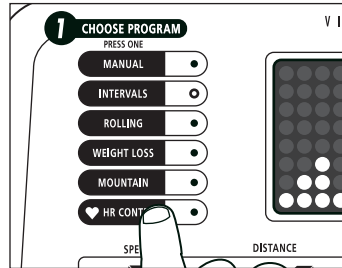

Using the Arrow buttons under 'CHOOSE LEVEL' select your Target Heart Rate, visible in the LEVEL window.

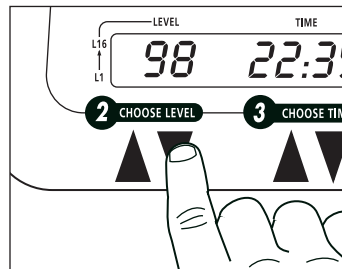

Using the Arrow buttons under 'CHOOSE TIME' select your Time, or you may use the default time of 24 Minutes.

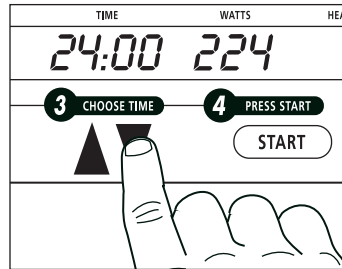

When you are ready to begin exercising press START.

The Elliptical Trainer will take you through a 5 minute warm-up period and then it will begin to raise the resistance until your Heart Rate is within +/- 5 Beats per Minute of the Target Heart Rate you entered. Then when you have 5 minutes left in your program the Elliptical Trainer will begin your cool-down period and lower the resistance.

ABOUT HEART RATE CONTROL

Your VISION FITNESS Elliptical Trainer offers two options for Heart Rate Control and Feedback; you may choose to use the convenient *Hand Contact Bars* or the hands-free *Wireless Chest Transmitter* (recommended for the Heart Rate Control Program).

CONTACT BAR HAND POSITION

Place the palm of your hands directly on the Contact Pads. Both hands must grip the bars for your Heart Rate to register.

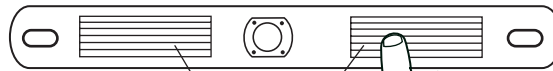
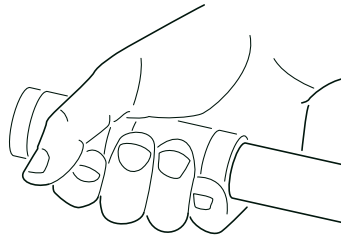

WIRELESS CHEST TRANSMITTER

Prior to wearing the Strap on your chest, moisten the two rubber contact strips with several drops of water and spread about with your fingers.

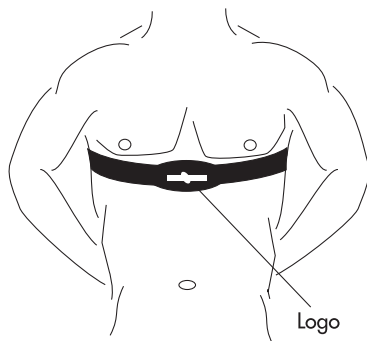
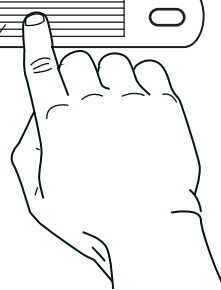

TRANSMITTER STRAP PLACEMENT

Center the Transmitter Strap just below the breast or pectoral muscles, directly over your sternum with the VISION FITNESS logo facing out.

TARGET HEART RATE ZONE

Your Target Heart Rate Zone is a percentage of your maximum heart rate. Target Zone will vary for each individual, depending on age, current level of conditioning, and personal fitness goals. The American Heart Association recommends working-out at a Target Heart Rate Zone of between 60% and 75% of your maximum heart rate. See the chart below for convenient reference.

EXAMPLE for 42-year old user: find AGE along bottom of chart (round to 40), follow AGE column up to TARGET ZONE bar. RESULTS: 60% of maximum Heart Rate = 108 Beats per Minute, 75% of maximum Heart Rate = 135 Beats per Minute. With this Target Zone of 108-135 Beats per Minute it is best to enter an average Target Heart Rate of about 122 Beats per Minute into the Console.

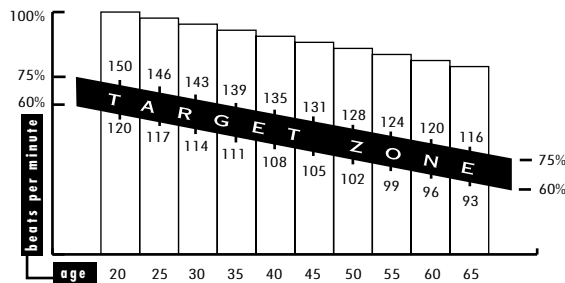

BENEFITS

- Weight Loss -- Helps you maintain an optimum exercise level to burn fat.
- Efficient -- Quantifies your exercise level for maximum benefit.
- Time Saver -- Makes the most of your limited workout time.
- Motivation -- Provides encouragement to achieve your fitness goals, and reach for new heights.

TOTAL BODY WORKOUT ON THE X6600DA DUAL ACTION ELLIPTICAL

By combining upper and lower body exercise in one machine, you get total body benefits from every workout. Because you're spreading the workload over all your major muscle groups, you can workout at higher intensities without fatiguing any one particular muscle. And by keeping all your muscles working aerobically (oxygen burning), your body will burn fat cells up to 25% more efficiently compared to other types of exercise.

UPPER BODY TONING

The total body workout of the X6600DA Dual Action Elliptical Trainer also helps tone your arm, shoulder, chest, back and leg muscles at the same time you enjoy the benefits of a superior aerobic exercise.

A NOTE ON GRIPPING THE ARMS

When using your Vision Fitness X6600DA Dual Action Elliptical Trainer, do not grip the arms tightly. Holding the grips tightly may elevate your blood pressure. Keep a loose, cupping hold as you push and pull the arms.

SYNCHRONIZED ARM AND LEG CONNECTION

The pedals and arms on your X6600DA Vision Fitness Dual Action Elliptical Trainer are linked together to reproduce a natural walking motion. When walking or running, your arm motion serves as your body's natural counterbalance, and the synchronized action of the X6600DA Dual Action Elliptical Trainer duplicates this benefit. With a fixed synchronized arm and leg action, you are assured of optimal body positioning at all times.

TROUBLESHOOTING YOUR ELLIPTICAL TRAINER

Our Elliptical Trainers are designed to be reliable and easy to use. If, however, you have a problem, these troubleshooting steps may indicate the cause.

PROBLEM: The Console does not light up.

SOLUTION: 1) Check to make sure the Elliptical Trainer is turned on (switch is located near power supply).

2) If you are using the Elliptical Trainer without a power supply, be sure you are *striding* fast enough to power the Console. If the problem persists, plug in the power supply, turn the Elliptical Trainer on and test to see if the Console powers up.

PROBLEM: The Elliptical Trainer appears to work but there is no resistance change.

SOLUTION: The magnetic brake assembly is not working properly; please contact your retailer.

PROBLEM: The Elliptical Trainer makes a squeaking or creaking noise.

SOLUTION: Check and tighten all the bolts on the Elliptical Trainer again.

NOTE: If the above steps do not remedy the problem, discontinue use, turn the power off and contact your retailer.

TROUBLESHOOTING YOUR HEART RATE MONITOR CHEST STRAP

PROBLEM: No pulse reading appears.

SOLUTION: There may be a poor connection between the contact pads and skin. Remoisten the electrodes.

SOLUTION: Transmitter is not properly positioned. Reposition the chest strap.

SOLUTION: Verify that the distance between transmitter and receiver is not beyond the recommended range of 36 inches.

PROBLEM: There is an erratic pulse rate.

SOLUTION: Chest strap is too loose; readjust according to directions.

NOTE: It is possible that heart rate monitors will not function properly on some people due to a variety of reasons. It may be necessary to experiment with the fit and position of the chest strap. Outside interference sources such as computers, motors, etc. are also a major source of problems for heart rate monitors.

COMMON ELLIPTICAL TRAINER QUESTIONS

Q: Are the sounds my Elliptical Trainer make normal?

A: Our Elliptical Trainers are some of the quietest available because they use belt drives and magnetic resistance. We use the highest grade European bearings and top quality belts to minimize noise. However, because the resistance system itself is so quiet, you will occasionally hear some slight mechanical noises from the drive train. Unlike older, louder technologies, there are no fans, friction belts, or alternator noises to mask these sounds on our Elliptical Trainers. These mechanical noises, which may or may not be intermittent, are normal and are caused by the transfer of significant amounts of energy to a rapidly spinning flywheel. All bearings, belts and other rotating parts will generate some noise which will transmit through the casing and frame. It is also normal for these sounds to change slightly during a workout, and over time, because of thermal expansion of the parts. Keep in mind that while you work out you're sometimes exerting the equivalent mechanical energy of a washing machine or dryer!

Q: Why is the Elliptical Trainer I had delivered louder than the one at the store?

A: All fitness products seem quieter in a large store showroom because there is generally more background noise than in your home. Also, there will be less reverberation on a carpeted concrete floor than on a wood overlay floor. Sometimes a heavy rubber mat will help reduce reverberation through the floor. And finally, if a fitness product is placed close to a wall, there will more reflected noise.

Q: When should I be worried about a noise?

A: As long as the sounds your Elliptical Trainer makes are no louder than a normal conversational tone of voice, it is considered normal noise. If your Elliptical Trainer is louder than this, you may want to call your service technician. Sometimes an initial diagnosis can be made over the phone.

Q: What kind of routine maintenance is required?

A: We use sealed bearings throughout our Elliptical Trainers so lubrication is not needed. The most important maintenance step is to simply wipe your perspiration off the Elliptical Trainer after each use.

Q: Will the magnets wear out over time?

A: No, we use permanent magnets that will retain their braking force indefinitely in this application. One of the big advantages of a magnetic brake is its long life since there is no physical contact between the flywheel and the magnet surface.

Q: How long will the drive belt last?

A: The computer modeling we had done indicated virtually thousands of maintenance-free hours. Belts are now used in far more demanding applications such as motorcycle drives.

LIMITED HOME USE WARRANTY

VISION FITNESS extends the following exclusive, limited warranty, which shall apply only to the use of the device in the home, for residential, non-commercial purposes only. Any other use of the device shall void this warranty.

VISION FITNESS hereby extends the following limited warranties for the following components of the device, for the time period indicated:

FRAME - LIFETIME VISION FITNESS warrants the Frame against defects in workmanship and materials for the life of the product, so long as it remains in the possession of the original owner.

ECB-PLUS™ BRAKE - LIFETIME VISION FITNESS warrants the ECB-PLUS™ Magnetic Brake against defects in workmanship and materials for the life of the product, so long as it remains in the possession of the original owner. Only the Brake and Magnet assembly, and no other ancillary components or parts, are covered by this lifetime warranty

ELECTRONICS & PARTS - THREE YEARS VISION FITNESS warrants the Electronic components and all original Parts (other than the ECB-PLUS™ Magnetic Brake) against defects in workmanship and materials for a period of three years from the date of original purchase, so long as the device remains in the possession of the original owner.

LABOR - TWO YEARS VISION FITNESS shall cover the Labor cost for the repair of the device for a period of two years from the date of original purchase, so long as the device remains in the possession of the original owner.

LIMITED HOME USE WARRANTY (continued)

EXCLUSIVE REMEDY

The exclusive remedy for any of the above warranties shall be repair or replacement of defective Parts, or the supply of Labor to cure any defect, provided that Labor shall be limited to two years. All Labor shall be supplied by the local Retailer and the product must be located within that Retailer's service area. Products located outside the Retailer's service area will not be covered by the Labor warranty.

EXCLUSIONS AND LIMITATIONS

This warranty applies only to the original owner and is not transferable. This warranty is expressly limited to the repair or replacement of a defective Frame, ECB-PLUS™ Magnetic Brake, Electronic component, or defective Part and is the sole remedy of the warranty. The warranty does not cover normal wear and tear, improper assembly or maintenance, or installation of parts or accessories not originally intended or compatible with the Fitness Product as sold. The warranty does not apply to damage or failure due to accident, abuse, corrosion, discoloration of paint or plastic, or neglect. VISION FITNESS shall not be responsible for incidental or consequential damages. Parts and Electronic components reconditioned to As New Condition by VISION FITNESS or its vendors may sometimes be supplied as warranty replacement parts and constitute fulfillment of warranty terms. Any warranty replacement parts shall be warranted for the remainder of the original warranty term.

VISION FITNESS expressly disclaims all other warranties, express or implied, including but not limited to all warranties of fitness for a particular purpose or of merchantability. This warranty gives you specific legal rights and your rights may vary from state to state.

WARRANTY REGISTRATION

Your warranty card must be completed and sent to VISION FITNESS before a warranty claim can be processed. You may also register via our website at www.visionfitness.com. Inside the enclosed warranty card you will find a customer survey. Your care in completing the survey will be of value to us in serving you in the future. Comments and suggestions are always welcome. We are certain you will enjoy your new Elliptical Trainer. Thank you for selecting a VISION FITNESS product.

LIMITED LIGHT COMMERCIAL WARRANTY

Up to 5 hours use per day

LIGHT COMMERCIAL USES DEFINED VISION FITNESS warrants models X6600HRC & X6600HRC DA for use in light commercial facilities including: Hotels, Resorts, Police & Fire Stations, Apartment Complexes, Corporate Fitness Centers, Hospitals, Rehabilitation and Sports Medicine Clinics, where average use is up to five hours per day. Not warranted for private Health Clubs, YMCA's or Schools.

FRAME, ECB-PLUS™ BRAKE, ELECTRONICS & PARTS - TWO YEARS VISION FITNESS warrants the Frame, ECB-PLUS™ Magnetic Brake, Electronic components and all original Parts against defects in workmanship and materials for a period of two years from the date of original purchase, so long as the device remains in the possession of the original owner.

LABOR - TWO YEARS VISION FITNESS shall cover the Labor cost for the repair of the device for a period of two years from the date of original purchase, so long as the device remains in the possession of the original owner.

EXCLUSIVE REMEDY

The exclusive remedy for any of the above warranties shall be repair or replacement of defective Parts, or the supply of Labor to cure any defect, provided that Labor shall be limited to two years. All Labor shall be supplied by the local Retailer and the product must be located within that Retailer's service area. Products located outside the Retailer's service area will not be covered by the Labor warranty.

LIMITED LIGHT COMMERCIAL WARRANTY (continued)

Up to 5 hours use per day

EXCLUSIONS AND LIMITATIONS

This warranty applies only to the original owner and is not transferable. This warranty is expressly limited to the repair or replacement of a defective Frame, ECB-PLUS™ Magnetic Brake, Electronic component, or defective Part and is the sole remedy of the warranty. The warranty does not cover normal wear and tear, improper assembly or maintenance, or installation of parts or accessories not originally intended or compatible with the Fitness Product as sold. The warranty does not apply to damage or failure due to accident, abuse, corrosion, discoloration of paint or plastic, or neglect. VISION FITNESS shall not be responsible for incidental or consequential damages. Parts and Electronic components reconditioned to As New Condition by VISION FITNESS or its vendors may sometimes be supplied as warranty replacement parts and constitute fulfillment of warranty terms. Any warranty replacement parts shall be warranted for the remainder of the original warranty term.

VISION FITNESS expressly disclaims all other warranties, express or implied, including but not limited to all warranties of fitness for a particular purpose or of merchantability. This warranty gives you specific legal rights and your rights may vary from state to state.

WARRANTY REGISTRATION

Your warranty card must be completed and sent to VISION FITNESS before a warranty claim can be processed. You may also register via our website at www.visionfitness.com. Inside the enclosed warranty card you will find a customer survey. Your care in completing the survey will be of value to us in serving you in the future. Comments and suggestions are always welcome. We are certain you will enjoy your new Elliptical Trainer. Thank you for selecting a VISION FITNESS product.

DEVELOPING A FITNESS PROGRAM

STRETCH FIRST

Before using your Vision Fitness Product, it is best to spend a few minutes during a few gentle stretching exercises. Stretching prior to exercise will improve flexibility and reduce chances of exercise related injury. Ease into each of these stretches with a slow gentle motion.

WALL PUSH

Stand near a wall, with the toes of one foot about 18" from the wall, and the other foot about 12" behind that. Lean forward, pushing against the wall with your palms. Keep your heels flat and hold this position for a count of 15 seconds. Do not bounce. Alternate the positions of your feet and repeat for a total of 8 repetitions.

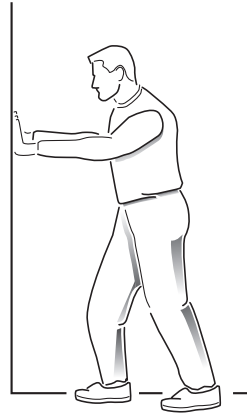

STANDING QUADRICEPS STRETCH

Using a wall or your Vision Fitness Product to provide balance, grasp your left ankle with your left hand and hold your foot against the back of your thigh for a count of 15 seconds. Repeat with your right ankle and hand, and continue alternating for a total of 8 repetitions.

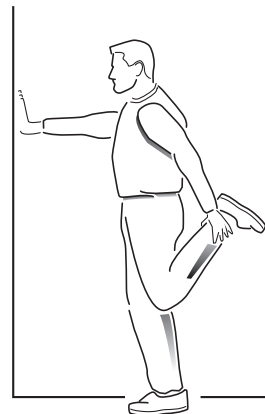

SEATED TOE TOUCH

Sit on the floor with your legs together and straight out in front of you. Do not lock your knees. Extend your fingers towards your toes and hold for a count of 15. Do not bounce. Sit upright again. Repeat for a total of 8 repetitions.

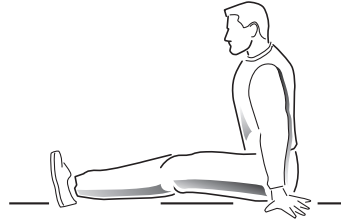

THE IMPORTANCE OF THE WARM UP AND COOL DOWN

WARM UP

The first 2 to 5 minutes of a workout should be devoted to warming up. The warm-up will limber your muscles and prepare them for more strenuous exercise. Warm-up on your Vision Fitness Product at a slow pace.

COOL DOWN

Never stop exercising suddenly! A cool-down period allows your heart to readjust to the decreased demand. Use a low resistance setting during the cool-down to gradually lower your heart rate. After the cool-down, repeat the above stretching exercises to loosen and relax your muscles.

EXERCISE GUIDELINES

Always consult your physician before beginning an exercise program.

HOW OFTEN?

The American Heart Association recommends that you exercise at least 3 to 4 days per week to maintain cardiovascular fitness. If you have other goals such as weight or fat loss you will achieve your goal faster with more frequent exercise. Whether it's 3 days or 6 days, remember that your ultimate goal should be to make exercise a

lifetime habit. Many people are successful staying with a fitness program if they set aside a specific time of day to exercise. It doesn't matter whether it's in the morning before your shower, during lunch hour or while watching the evening news. What's more important is that it's a time that allows you to keep a schedule, and a time when you won't be interrupted. If you are to be successful with your fitness program, you have to make it a priority in your life. So decide on the time, pull out your day planner and pencil in your exercise times for the next month!

HOW LONG?

For aerobic exercise benefits, it's recommended that you exercise from between 24 and 32 minutes per session. But start slowly and gradually increase your exercise times. If you've been sedentary during the past year, it may be a good idea to keep your exercise times too as little as five minutes initially. Your body will need time to adjust to the new activity. If your goal is weight loss, a longer exercise session at lower intensities has been found to be most effective. A workout time of 48 minutes or more is recommended for best weight loss results.

HOW HARD?

How hard you workout is also determined by your goals. If you use your Vision Fitness Product to prepare for racing, you will probably work out at a higher intensity than if your goal is

general fitness. Regardless of your long term goals, always begin an exercise program at low intensity. Aerobic exercise does not have to be painful to be beneficial! There are two ways to measure your exercise intensity. The first is by monitoring your heart rate, and second is by evaluating your perceived exertion level (this is simpler than it sounds!).

PERCEIVED EXERTION LEVEL

The way to gauge your exercise intensity is to evaluate your perceived exertion level. If while exercising you are too winded to maintain a conversation without gasping, you are working out too hard. A good rule of thumb is to work to the point of exhilaration, not exhaustion. If you cannot catch your breath, it's time to slow down. Always be aware of other warning signs to overexertion.

ACHIEVING YOUR FITNESS GOALS

An important step in developing a long term fitness program is to determine your goals. Is your primary goal for exercising on your Vision Fitness Product to lose weight? Improve muscle? Burn Stress? Prepare for the spring racing schedule? Knowing what your goals are will help you develop a more successful exercise program. Below are some common exercise goals:

- Weight Loss
- Weight Maintenance
- Improve Body Shape and Tone
- Strengthen Leg Muscles
- Increased Energy Level
- Improved Sleep Patterns
- Improved Cycling/Cross Sports Performance
- Improved Cardiovascular Endurance
- Stress Reduction

If possible try to define your personal goals in precise, measurable terms, and then put your goals in writing. The more specific you can be, the easier it will be to track your progress. If your goals are long term, divide them up into monthly and weekly segments. Longer term goals can lose some of the immediate motivation benefits. Short term goals are easier to achieve. Your Vision Fitness Product console provides you with several readouts that can be used to record your progress. You can track Distance, Calories or Time. Time is the most important and useful of test functions.

SAMPLE GOALS:

Goal setting is a popular motivational technique. It's important to set goals and reward yourself when initiating a new exercise program because you're attempting to break current patterns and form a new habit. Whether you use this technique or another, make fitness a priority in your life. You can achieve the ultimate reward to yourself: you can establish the exercise habit!

Some sample goals may be:

- To strengthen my heart by exercising 24 minutes three days a week.
(Goal Measurement: Exercise Time=72 minutes a week).
- To improve my body's ability to burn fat by exercising at a low intensity for 48 minutes per day, 5 days a week.
(Goal Measurement: Exercise Time=240 minutes per week).
- To burn off work related stress by exercising for 20 minutes a day on work days.
(Goal Measurement: Exercise Time=100 minutes per week).

KEEPING AN EXERCISE DAIRY

Photocopy the weekly and annual log sheets on the following pages to make your personal exercise log book. As time goes by you'll be able to look back with pride at the work you've done. As your fitness improves, you can look back and see how far you've come.

WEEK # _____		Weekly Goal: _____			
		Scheduled Workout Time: _____			
		My Reward is: _____			
Day	Date	Workload Level	Exercise Time	Distance	Comments
Sunday					
Monday					
Tuesday					
Wednesday					
Thursday					
Friday					
Saturday					
Weekly Totals					

WEEK # _____		Weekly Goal: _____			
		Scheduled Workout Time: _____			
		My Reward is: _____			
Day	Date	Workload Level	Exercise Time	Distance	Comments
Sunday					
Monday					
Tuesday					
Wednesday					
Thursday					
Friday					
Saturday					
Weekly Totals					

WEEK # _____		Weekly Goal: _____			
		Scheduled Workout Time: _____			
		My Reward is: _____			
Day	Date	Workload Level	Exercise Time	Distance	Comments
Sunday					
Monday					
Tuesday					
Wednesday					
Thursday					
Friday					
Saturday					
Weekly Totals					

WEEK # _____		Weekly Goal: _____			
		Scheduled Workout Time: _____			
		My Reward is: _____			
Day	Date	Workload Level	Exercise Time	Distance	Comments
Sunday					
Monday					
Tuesday					
Wednesday					
Thursday					
Friday					
Saturday					
Weekly Totals					

developing your fitness program

January		
Week #	Minutes	Distance
Monthly Total		
Monthly Reward		

February		
Week #	Minutes	Distance
Monthly Total		
Monthly Reward		

March		
Week #	Minutes	Distance
Monthly Total		
Monthly Reward		

April		
Week #	Minutes	Distance
Monthly Total		
Monthly Reward		

May		
Week #	Minutes	Distance
Monthly Total		
Monthly Reward		

June		
Week #	Minutes	Distance
Monthly Total		
Monthly Reward		

developing your fitness program

July			August		
Week #	Minutes	Distance	Week #	Minutes	Distance
Monthly Total			Monthly Total		
Monthly Reward			Monthly Reward		
September			October		
Week #	Minutes	Distance	Week #	Minutes	Distance
Monthly Total			Monthly Total		
Monthly Reward			Monthly Reward		
November			December		
Week #	Minutes	Distance	Week #	Minutes	Distance
Monthly Total			Monthly Total		
Monthly Reward			Monthly Reward		

developing your fitness program

vision fitness

the vision to succeed



621-D East Lake Street • P.O. Box 280 • Lake Mills, WI 53551
toll free 1.800.335.4348 • phone 1.920.648.4090 • fax 1.920.648.3373
www.visionfitness.com

© 1999 Vision Fitness. All Rights Reserved. Easy-8, One-Button Start and Bio-Radius are
Trademarks of Vision Fitness.
10.99

Free Manuals Download Website

<http://myh66.com>

<http://usermanuals.us>

<http://www.somanuals.com>

<http://www.4manuals.cc>

<http://www.manual-lib.com>

<http://www.404manual.com>

<http://www.luxmanual.com>

<http://aubethermostatmanual.com>

Golf course search by state

<http://golfingnear.com>

Email search by domain

<http://emailbydomain.com>

Auto manuals search

<http://auto.somanuals.com>

TV manuals search

<http://tv.somanuals.com>