



INTERNATIONAL  
FOODSERVICE

# Owner's Manual

Read And Save These Instructions



# ***Touch and Go™*** **Blending Station®**

High Performance Commercial Blender

220/240 and 100 VAC Models

# IMPORTANT SAFEGUARDS

1. Read all instructions.
2. To protect against risk of electrical shock, do not put motor base in water or other liquid.
3. Close adult supervision is necessary when appliance is used by or near children.
4. Unplug the power cord from the wall outlet when the Touch and Go™ Blending Station® is not in use, before putting on or taking off parts, and before cleaning other than washing the container.
5. Never contact moving parts.
6. Do not operate any appliance with a damaged cord or plug or after the appliance malfunctions or is dropped or damaged in any manner.  
**For information on a local distributor call Vita-Mix Service at +1(440) 235-5494. For Latin America call +1(440) 235-0214.**
7. The use of attachments not recommended or sold by Vita-Mix Corporation may cause fire, shock, or injury.
8. **Do not use outdoors.**
9. Do not let the power cord hang over edge of table or counter, or touch hot surfaces.
10. Keep hands and utensils out of container while motor is running to prevent the possibility of severe personal injury and/or damage to the Blending Station. A rubber scraper may be used, but only when the Blending Station is not running.
11. **CAUTION: Blade is sharp. Handle carefully.**
  - Never try to remove blade while container is sitting on the motor base.
  - Do not operate with loose, knicked or damaged blades.
  - To reduce the risk of personal injury, never place blade assembly on motor base without blender container properly attached.
12. The maximum normal load is equivalent to the liters listed on the container, 2 L, 1.5 L, 1.25 L and substantially less with thick mixtures.

13. Always operate with the lid in place.
14. **WARNING:** When processing hot liquids:
  - The 2-part latching lid must be securely in place. This allows steam to escape naturally, and will prevent the lid from coming off when the machine is turned on.
  - Use caution with hot liquids. Spraying from under the lid plug can occur, or escaping steam may cause scalding.
  - Do not process hot liquids with the non-latching lid.
15. Display window area will scratch when contacted with a scouring pad or sharp object. Use a soft cloth to wipe the control panel area clean.
16. The optional interlock switch on some 220/240 VAC Blending Stations® will prevent the machine from running unless the cover door is completely closed.
17. The Blending Station cannot be cleaned with a water jet.

***SAVE THESE INSTRUCTIONS***

# Control Panel

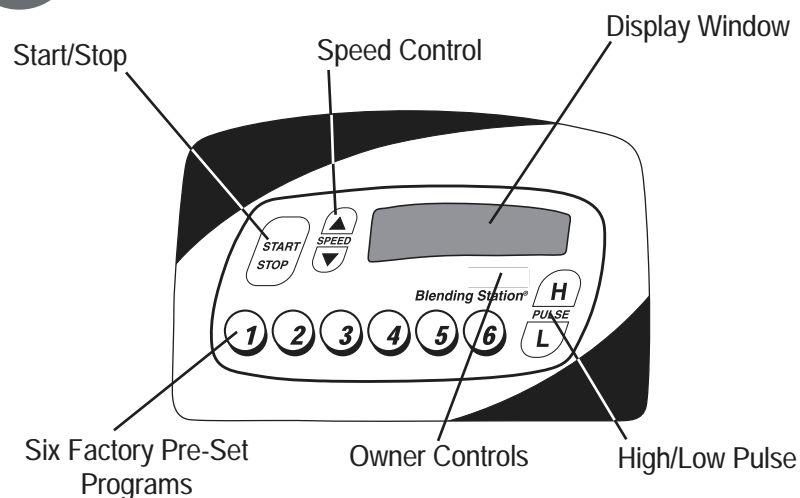

## Touch and Go™ Blending Station®

**ON/OFF switch** - Located on the side of the Motor Base the ON/OFF switch controls the power to the machine. With the machine plugged in, switch the machine to ON to ready the machine for blending.

**START/STOP button** - Pressing START/STOP once *starts* and *runs* the machine and turns the blades. Press the START/STOP button again to *stop* the machine and the blades. (**NOTE:** Pressing one of the PRE-SET PROGRAM buttons, while the motor is running, will also stop the machine.)

**SPEED CONTROL button** - Press the ▲ button to gradually *increase* the speed of the blades in increments of 1%, up to 100%. Press the ▼ button to gradually *decrease* the speed of the blades in increments of 1%, down to 7%. SPEED CONTROL is used to set the blending speed of the PULSE buttons (See Instructions, pg.15) and the START/STOP button (See Instructions, pg. 15). **NOTE:** These settings will reset if the power is shut off.

**PRE-SET PROGRAM buttons** - These buttons, numbered 1 thru 6, are pre-programmed blending cycles designed for the most commonly made drinks. Depending on the viscosity of the drink you are creating, pressing one of the six PRE-SET PROGRAM buttons will run the machine for a full cycle. The machine will stop by itself when the cycle is complete. A cycle varies in speed and length, see the Instructions on page 14 for a complete description of the range of each PRE-SET button.

Due to the difference of recipes, your results may vary.

See page 6 for information on Custom Programming these six buttons.

**DISPLAY WINDOW** - This area depending on what button is pressed, displays a variety of operation messages. A 'Ready' message appears when there is power to the machine.

**OWNER CONTROLS** - A control panel accessible by pressing the Vita-Mix logo.

- Press once to reveal the mode message. Press button

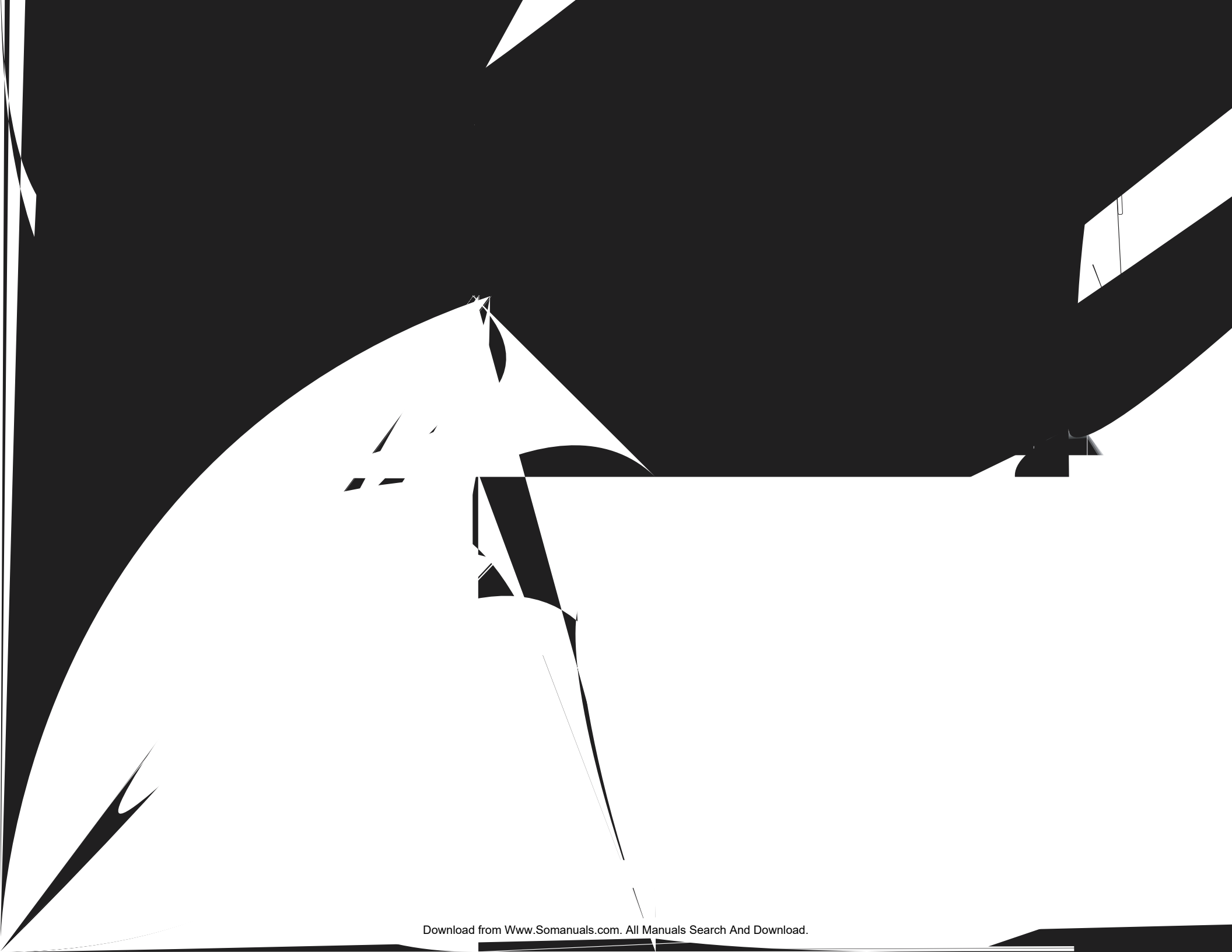

# In-Counter Installation

## Preparing the counter area:

- Before cutting holes, make sure that there is adequate clearance under the counter for the motor. The motor will extend about 14.4 cm below the counter but it is best to allow at least 25.4 cm from the under-counter to shelves or any other equipment under the counter. Also, when using the removable cover design, the back of the hole must be at least 15.2 cm from any wall to allow for cover door clearance.
- An extra 16.5 cm of open space, above the top of the cover will be needed for placement and removal of the In-Counter machine and for custom programming the SIX PRE-SET Buttons.
- If installing unit into a closed cabinet, use a 10.1 cm diameter flexible vinyl duct (dryer hose) to vent exhaust. Attach the vinyl duct to the bottom of your In-Counter Touch and Go™ Blending Station® by forcing the end of the hose over the exhaust baffle of the unit. Run the vinyl duct out of the cabinet for proper ventilation. Do not vent hose into a wall, ceiling, or a concealed space of a building. Multiple units should not vent to a common manifold unit but to separate places. If running your Blending Station causes a suction on your cabinet door, place a spacer in the door frame to allow proper intake of air.

 Do not use hose clamps or equivalent to attach exhaust hose on machine.

- When cutting holes for placement of multiple In-Counter units, position the edge of the machines at least 30.48 cm apart to ensure quick cleaning and proper venting between machines.
- In-Counter installation also requires you to have at least one outlet per machine under the counter, available within six feet of the Blending Station. Consult an electrician for proper electrical needs.
- The In-Counter Blending Station also requires a foam gasket (provided in the machine's original package) to be placed between the machine and the counter. See page 10 for instructions.

## Electrical requirements:

- Volts: 220/240 VAC • 50 or 60 Hz. • 1073-1178 Watts
- Volts: 100 VAC, 60 Hz., 900 Watts (Japan)

## Blending Station dimensions:

- 44.45 cm high with lid closed
- 54.7 cm high with lid open
- Case depth: 31.75 cm with handle
- Case width: 24.3 cm
- Depth below counter: 14.4 cm
- Recommended distance between machines: 30.48 cm from the edge of each machine or as far apart as possible.

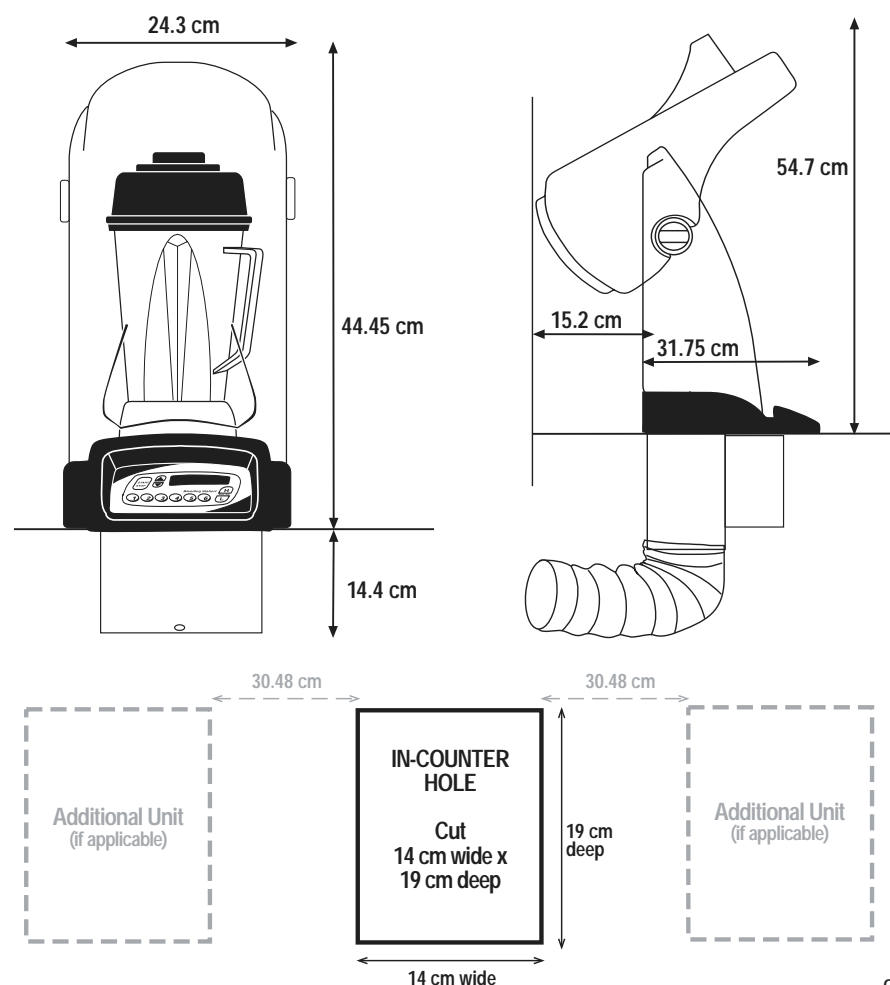

# In-Counter Gasket

## Gasket Installation Instructions:

1. Follow the instructions on page 8 on preparing the counter area for the installation of your In-Counter Touch and Go™ Blending Station. Also, use the Template Sheet (provided in your machine's original package) to assist you in the placement and ventilation of your machine.
2. Peel off the white paper on the back of the black In-Counter Gasket Foam Pad to reveal the adhesive backing.
3. Place adhesive side down onto the counter being careful to match up the gasket hole with the hole you have cut in the counter.
4. When you have matched up the holes, firmly press down on all sides so that the gasket is firmly attached.
5. Fold flap inside the hole down towards the ground.
6. Insert your Touch and Go Blending Station inside the hole, making sure the flap is down snug against the machine.
7. Do not secure the machine to counter with bonding materials.

 This gasket was designed to protect your machine from water damage and to reduce noise. Failure to properly install this gasket could result in moisture damage.

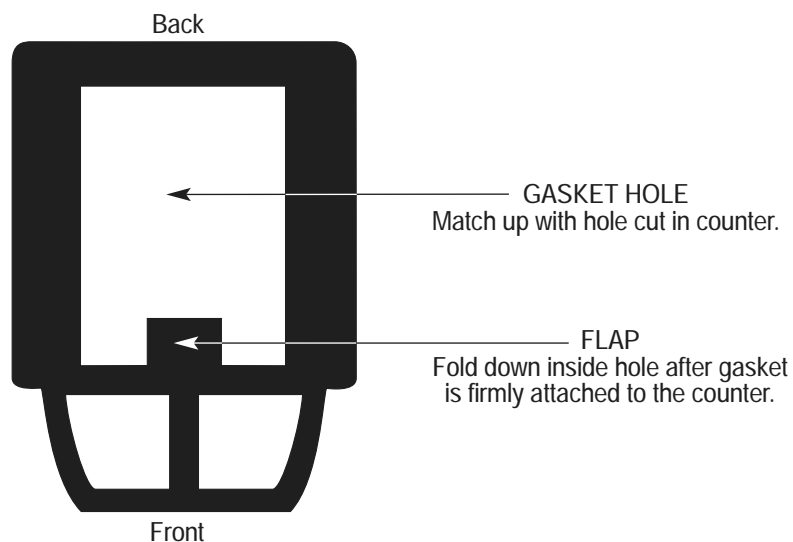

# Blending Tips

1. If your recipe freezes up, try reducing the amount of ice. Compared to other blenders, you do not need as much ice to make an equally frozen drink in a Touch and Go™ Blending Station.®
2. Place liquids and soft foods in your container first. Hard items and ice should be placed last.
3. Whole, hard or frozen ingredients should be small. Solid frozen fruit is extremely difficult to blend. For best results use semi-frozen fruit. Using same size batches of semi-frozen fruit and ice will keep your drinks consistent. If you notice chunks, reevaluate the batch size.
4. When creating recipes, always allow for enough liquid to ease the blending process. For recipes with minimal liquid, use the SPEED CONTROL buttons to run the machine on its lowest settings until it is processing smoothly. Finish blending by using one of the PRE-SET PROGRAMS that best matches the drinks viscosity.

## Maintenance Tips:

- **NEVER** bang the container against a surface to loosen the ingredients. Remove the container from the base and use a rubber spatula to remove thick mixtures from the bottom of your container.
- **NEVER** shake or rattle a container in use while seated on the motor base.
- **NEVER** remove the container before the machine has come to a complete stop.
- **NEVER** start the motor before the container is in place.

 The instructions appearing in this Owner's Manual cannot cover every possible condition and situation that may occur. Common sense and caution must be practiced when operating and maintaining any appliance.

# Lid Assembly

## Two-part Lid

### 1.5 Liter Polycarbonate container

The two part lid is easy to clean and easy to put on, take off and seal.

- To remove fully latched lid, squeeze tabs together on both sides of the container, pull upward and off.
- Twist the center lid plug to fasten or remove.

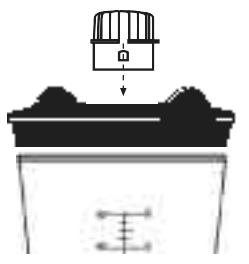

Figure A

**NOTE:** To make new lids easier to insert and remove, rub a light coating of cooking oil around bottom where it seals. Place it in container for several minutes, remove and lightly wipe oil off lid.

## Two-part Lid

### 2 Liter Polycarbonate container

The two part lid is easy to clean and easy to put on and take off. (Note: Brand new lids are a little stiff. This is temporary.)

- The lid has a continuous rim which latches inside the container tabs. Push one side of the rim under one tab, and with the heel of your hands push down, over the opposite tab, to snap lid into position.
- To remove lid, place hands around the lid, pressing thumbs above one of the container tabs. Push in and lift off.
- Twist the center lid plug to fasten or remove.

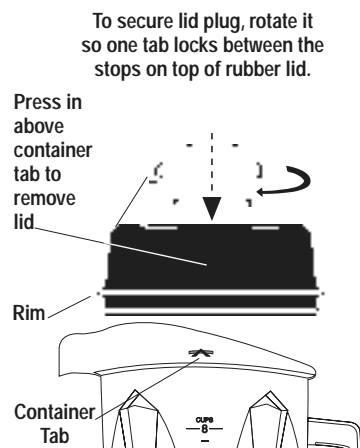

Figure B

Always latch lid when processing hot liquids.

## One Piece Lid (optional)

### 2 Liter Polycarbonate container

The one piece lid is easy to clean and easy to put on and take off.

(Note: Brand new lids are a little stiff. This is temporary.)

- There is no latch on this lid.
- Add ingredients through port on top.

**CAUTION:** Do not use non-latching lid when processing hot ingredients.



Figure C

## Cover with Removable Hinge Design

### Cover Door:

- The cover door can be removed by opening it until the curved bottom of the cover and the back cover form a 90° angle. Then lift straight up. (Figure D)
- To reinstall the cover door, align the hinge opening with the hinge on the back cover and slide the two together.

### Back Cover:

- The back cover can be removed by loosening the two screws in the back of the machine. Then lightly tap or pull the back cover toward the front of the machine until it loosens from the grooves on the base. (Figure E)
- To reinstall the back cover slide on to the base until latched in place. Reinstall screws.
- The back cover should only be removed if in need of replacement.

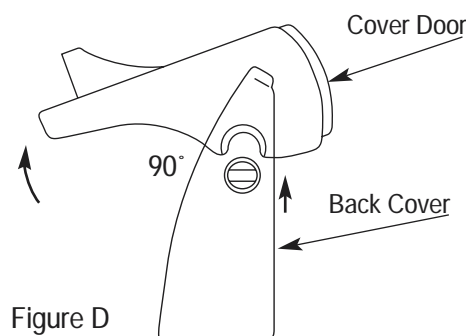

Figure D

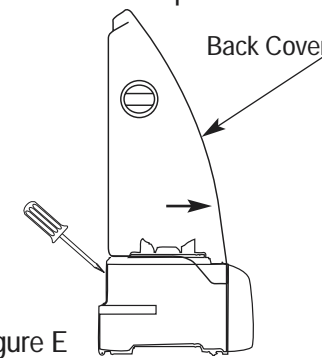

Figure E



# I nstructions

## **How to operate your Blending Station® using the six Pre-Set Programmed buttons.**

The following is the basic factory settings of the six PRE-SET buttons (your machines PRE-SET buttons may be different if your Blending Station was programmed specifically for your business).

- **Button 1:** (:15) *Blends thin drinks with just juice and ice.* This program will quickly ramp to a high blending speed for 15 seconds.
  - **Button 2:** (:20) *Blends light coffee drinks.* Button 2 will ramp the blending speed to medium for six seconds and ramp up to high for 14 seconds.
  - **Button 3:** (:32) *Creates a specialty drink with a thick viscosity.* Button 3 runs at a medium speed, ramps down, then increases to high speed, and finishes the drink at medium speed.
  - **Button 4:** (:34) *This cycle is good for ice cream and regular coffee drinks that need a little longer blending.* Button 4 increases to medium speed for four seconds then ramps up slowly to a high speed for 14 seconds.
  - **Button 5:** (1:35) *Blend a regular smoothie for an extended cycle.* Button 5 runs for 45 seconds on a medium speed and then increases in speed and runs on high for 50 seconds.
  - **Button 6:** (:25) *Blend thick frozen fruits & hard ingredients for a thick but consistent smoothie.* Button 6 gradually ramps up the blending speed, maintaining intermediate speeds and gradually progressing until it reaches full speed.
1. Place liquids and soft foods in the machines container first, solid items and ice last. Prepare food by cutting or breaking into 1-3 inch pieces. Frozen fruit, especially, should be as small as practical. Thawed or partially thawed fruit is recommended. We recommend PRE-SET button 5 or 6 for heavy-duty blending.
  2. Set the container on the motor base by aligning it over the centering pad anchored to the base. **(Motor must be completely stopped before positioning container).** Containers are not to be used for hard, dry materials. Avoid running the Blending Station with container empty.
  3. Always use a lid when blending. If blending hot ingredients, the lid must be securely in place.

4. Select desired programmed setting by pressing any of the Pre-Set Buttons 1 through 6. The machine will begin immediately to cycle through the selected program, and turn off when the program is complete. Each button has a different pre-selected combination of speed and length for blending.

**NOTE:** If you detect a change in the sound of the machine or if a hard or foreign object comes into contact with the blades, do not serve the drink. Inspect your blade assembly for loose, knicked or missing parts. If parts are loose, missing or knicked replace with a new blade assembly. (See page 17).

5. Once one of the six PROGRAMMED buttons is pushed the machine will start and stop automatically. By pressing another PROGRAMMED button or the START/STOP button, the machine will stop the blending cycle.
6. During any of the blending cycles, by pressing the PULSE (H) button the speed of the blending can increase up to 100% of the motor speed. By pressing the PULSE (L) button during a blending cycle the speed of the motor can be decreased down to 7%. Once released the motor speed will revert back to the blending cycle of the PRE-SET PROGRAM.

**NOTE:** The PULSE high(H) and low(L) speed is set by using the SPEED CONTROL buttons. To set, while pressing and holding a PULSE button, press the SPEED CONTROL ▲ or ▼ button until the desired motor speed is reached. The PULSE speed will remain at this setting until changed again with the SPEED CONTROL buttons.

7. When the cycle is complete the blender stops, **wait until blade comes to a complete stop before removing the lid and/or container from the motor base.**
8. Remove the container, pour, garnish and serve the drink.

## **How to operate your Blending Station® using the Start/Stop and Speed Control button.**

Although using the PRE-SET PROGRAMMED buttons is highly recommended for the best drink, occasionally a drink may need special attention. By using the START/STOP button and the SPEED CONTROL button you can manually control the speed of the Blending Station.

CONTINUED ON PAGE 16



1. Follow steps one through three of 'Using The Pre-Set Programmed buttons' section on page 14.
2. The speed of the motor can be changed with:

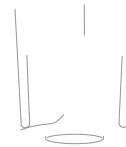

**Blade Agitator Assembly.** Use caution when handling the blade; it is sharp. When inserting the blade assembly through the container bottom, grip the blades with a soft cloth, align the flat sides of the blade assembly with the flat sides of the container. Place the retainer nut back on the inserted blade assembly and tighten clockwise. **Do not force. Do not attempt to disassemble blade assembly.**

**Drive Spline.** Mates with drive socket on the motor base to turn the blade. NOTE: Removing and replacing your container while the coupling is still rotating will strip the drive spline "teeth". (This part is NOT removable.)

**Retainer Nut.** Must be snug. Use the available retainer nut wrench for best results. (Refer to the diagram below to remove or replace.)

3. The PULSE buttons can also be used to temporarily increase the motor speed or decrease the motor speed. (See HIGH/LOW PULSE button description on page 5.)
4. When done blending press the START/STOP button to stop the motor. **Wait until blade comes to a complete stop before removing the lid and/or container from the motor base.**
5. Remove the container from the motor base and serve the drink.

**NOTE:** On all units the built-in thermal sensor keeps track of how hot the motor gets and will warn the user and eventually shut down the motor if the motor is overheating. When overheated the display will instruct the user to remove the container and run the machine until cool. This takes about a minute. See page 23 "Cooling the motor" for complete instructions.

When overheating occurs, review your techniques and instructions. The motor may be getting hot when your recipes are too thick. Consider adding more liquid or consult Vita-Mix for further assistance.



### **Retainer Nut Removal**

- The retainer nut is easily removed using a 15 cm screwdriver.\* Turn container upside down and insert screwdriver shaft between the lobe and drive spline. Push the screwdriver handle counterclockwise to loosen nut. Once loosened, remove by hand.
- To replace, position retainer nut on top of blade assembly and hand tighten. Then, using the screwdriver, tighten clockwise until it stops. If it is not tight enough, you will notice increased container noise.

\*For best results we recommend using a Retainer Nut Wrench in place of a screwdriver. To order ask for item #1222

# Parts List

Item#	Part
#752	2 liter - Container without lid assembly or blade assembly
#755	2 liter - Lid plug
#756	2 liter - Container, blade assembly & lid assembly
#1191	2 liter - 2-piece lid assembly
#1192	2 liter - Lid only (no plug)
PLS145	2 liter - 1-piece non-latching rubber lid
#1159	1.5 liter - Lid plug
#15502	1.5 liter - Container only
#15506	1.5 liter - Container, blade & lid assembly
#15507	1.5 liter - 2-piece lid assembly
#18002	Back cover and cover door with removable hinge design
#18003	Cover door with removable hinge design
#18004	Back cover with removable hinge design
#791	Sound reducing centering pad
#802	Drive socket
#836	Heavy-duty retainer nut
#1151	Agitator assembly (ice blades)
#1222	Retainer nut wrench
KIT107	Metal Screws - (2) 3.5 mm x 8 mm
RBB161	In-Counter Gasket Foam Pad

**NOTE:** Blade Assembly, Drive Socket and Retainer Nut are compatible on either the polycarbonate or stainless steel containers. Other than the Drive Socket, Blade Assembly and Retainer Nut, this unit is not user serviceable.

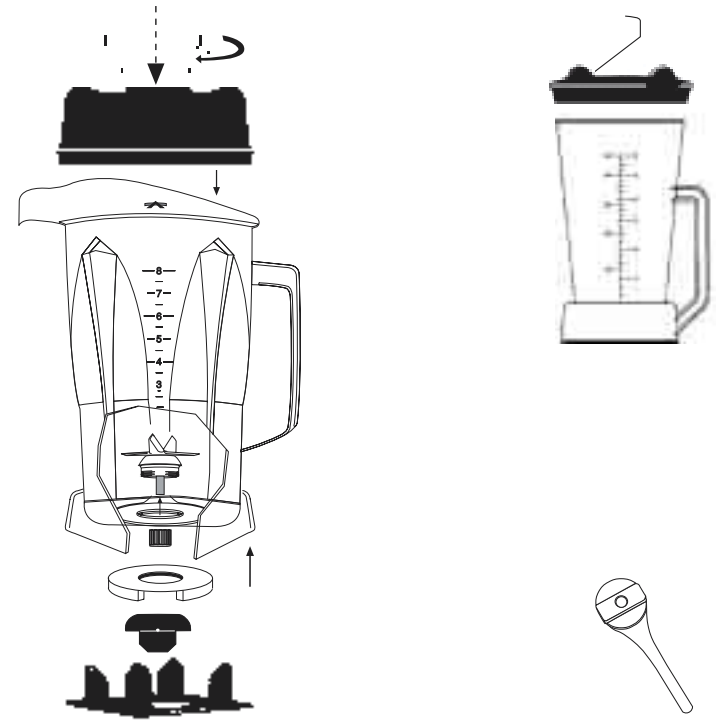

# Care and Cleaning

## Care Note

Do not let mixtures, liquids and food products dry within the container. Rinse throughout use. Drying product may lock around the blade and weaken/tear the bearings seal when restarted. Do not place containers in the freezer. Extremely low temperature combined with hot ingredients and/or the immediate rapid action of the blade may crack the container.

## Motor Base

1. Unplug the power cord.
2. Wash outside surface with a damp soft cloth or sponge, which has been rinsed in a mild solution of liquid dish soap (Ivory Liquid® or equivalent) in warm water. NEVER IMMERSE MOTOR BASE IN WATER OR OTHER LIQUID.
3. Polish with a soft cloth.

## Control Panel

Gently wash the front panel with a soft cloth and a low pH balance soap, being careful not to scratch the Display Window.

**NOTE:** Be sure to wring excess water out of cloth or sponge when cleaning around the controls, drive socket or any electrical part.

## Lid

Separate the lid and plug, then wash in warm soapy water. Rinse clean under running water and dry. Reassemble before use. (See pages 12 & 13).

## Cover Door

The cover can be removed (See page 13) and cleaned by placing under running water and washing with a soft cloth. Wipe dry and place back on the base.

## Container

1. To clean: Fill pitcher 1/4 full with warm (43°C) water and add a couple drops of dish soap.\* Return container to motor base and firmly position the two part lid. Run machine for 30 seconds. Empty container. Repeat this step.
- \*NOTE: Polycarbonate container, cover and thermoplastic rubber lid are dishwasher safe. However, to prolong the life of these parts, Vita-Mix® recommends using a low pH balance soap. For maximum container life, do not use standard dishwasher soaps which contain a high pH balance.
2. Fill pitcher 3/4 full with warm (43°C) water (do not add soap). Return container to motor base and firmly position the two part lid. Run machine for 30 seconds. Empty container.
3. If any solid residue remains, remove the blade agitator assembly (see page 17) and wash all container parts in warm soapy water. Rinse and drain. Reassemble before next step.



Do NOT soak the blade agitator assembly.

4. To sanitize: If all solid residue is gone after step 2 or after completion of step 3, fill container 3/4 full with a sanitizing solution mix.\*\* Return container to motor base and firmly position the two part lid. Run machine on HIGH for 30 seconds. Empty container.
5. Return container to motor base and run machine empty for an additional 5 seconds. Do not rinse after sanitizing.

\*\*Recommended sanitizing solution: 1-1/2 teaspoons Chlorox® institutional bleach in 2 liters water.



**Important: Check your blades daily for loose, knicked or missing parts. If you find something is loose, knicked or missing, replace the blade assembly before use. Do not tighten hex-headed screw (on top of blade assembly). If loose, replace blade assembly.**

# Troubleshooting

## Top nine problems you can fix on your own:

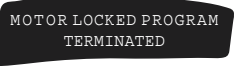
<p><b>1. Problem:</b></p> <ul style="list-style-type: none"> <li>• Display Panel reads</li> </ul> 	<p><b>Solution #1:</b> Turn the machine off and on again to reset the programming</p> <p><b>Solution #2:</b> Contact your dealer or local distributor.</p>
<p><b>2. Problem:</b></p> <ul style="list-style-type: none"> <li>• loud noise from blender container blade area</li> <li>• container blades do not spin</li> <li>• increased vibration</li> <li>• leaking from bottom of container</li> </ul>	<p><b>Solution #1:</b> Broken or worn Drive Socket. Replace (Item # 802). Instructions are included with part.</p> <p><b>Solution #2:</b> Check blade assembly for loose, damaged or knicked components and replace.</p> <p><b>Solution #3:</b> Tighten retainer nut on the bottom of the container</p>
<p><b>3. Problem:</b></p> <ul style="list-style-type: none"> <li>• loud grinding noise from the blender motor</li> </ul>	<p><b>Solution #1:</b> Due to some faulty motor bearings your machine may need to be repaired. Contact your dealer or local distributor.</p>
<p><b>4. Problem:</b></p> <ul style="list-style-type: none"> <li>• Machine will not run</li> <li>• Display screen does not say 'READY'</li> </ul>	<p><b>Solution #1:</b> Double-check to make sure power cord is firmly in power outlet.</p> <p><b>Solution #2:</b> Check to make sure the ON/OFF switch is in the ON position.</p> <p><b>Solution #3:</b> Turn the ON/OFF switch to off, then on, to reboot the electronics.</p>
<p><b>5. Problem:</b></p> <ul style="list-style-type: none"> <li>• machine starts then shuts off</li> </ul>	<p><b>Solution #1:</b> Check to make sure there is power to the machine.</p> <p><b>Solution #2:</b> Contact your dealer or local distributor.</p>
<p><b>6. Problem:</b></p> <ul style="list-style-type: none"> <li>• Display Panel reads</li> </ul> 	<p><b>Solution #1:</b> Let the machine cool down for an hour then restart.</p> <p><b>Solution #2:</b> Contact your dealer or local distributor if the machine does not work after sitting at room temperature for 24 hours.</p>

- 7. Problem:**
- Machine is running irregular
  - Display panel reads garbage
  - "NO PROGRAM" is displayed when a button is pushed
  - Button pressed starts the wrong program
  - Machine starts by itself
  - a specific program button is defective
  - machine was turned off for a day, week or month and turned on, there was no power
  - machine did not work right out of the box
  - machine works but no information displayed on screen
  - program buttons run the blender on the same speed

- Solution #1:**  
Turn the machine off and on again to reset the programming
- Solution #2:**  
Reset the machine to its original factory settings. (Follow the instructions on page 7)
- Solution #3:**  
Try plugging the machine into a new outlet.
- Solution #4:**  
Contact your dealer or local distributor.

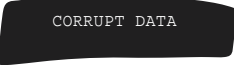
- 8. Problem:**
- Display panel reads
- 

- Solution #1:**  
A new programming chip is needed. Contact your dealer or local distributor.

- 9. Problem:**
- Machine stops in the middle of its blend cycle and resets; display panel reads "VITA-MIX GENERAL PROGRAM" then "READY"

- Solution #1:**  
Plug the machine into its own power supply
- Solution #2:**  
Make sure the machine is not running on a long extension cord

## Cooling the motor:

### If the machine has overheated:

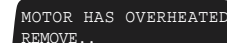

- The motor will stop and the message "MOTOR HAS OVERHEATED REMOVE THE CONTAINER, THEN PRESS START", will scroll across the display window, while the words "HOT SHUTDOWN" will remain in the display window alerting you of the problem.
- The machine will not run until the container is removed and the motor has cooled. Remove the container, shut the cover door and press the START/STOP button, and run the machine for two minutes.
- When the motor is cool "READY" will appear in the display window.



If you cannot fix your machine with these suggestions, contact your dealer or contact Vita-Mix International at +1(440) 235-5494 for a local distributor, for Latin America call +1(440) 235-0214, or visit us at [www.vitamix.com](http://www.vitamix.com)

# *Specifications*

## **Blending Station® On-Counter:**

Height of unit closed: 54.56 cm • Shipping weight: 9.534 kg  
Dimensions 54.56 cm H x 23.45 cm W x 25.86 cm D

## **Blending Station In-Counter:**

Height of unit above counter: 44.45 cm closed  
Depth of unit below counter: 14.4 cm • Shipping Weight: 8.172 kg  
Dimensions: 45.03 cm H x 23.45 cm W x 25.86 cm D

**NOTE:** For In-Counter Installation refer to pages 8-10.

## **Power Requirements:**

Volts: 220/240 VAC, 50 or 60 Hz, 1073-1178 Watts  
100 VAC, 60 Hz, 900 Watts (Japan)

## **Warranty Information:**

Call or check with your local distributor for details of any available warranty. Provisions of any warranty are void if your Touch and Go™ Blending Station® has been subjected to obvious abuse, negligence, accident, alteration, or failure to follow operating instructions, or product exposure to abnormal or extreme conditions. Cosmetic changes such as discoloration of parts of the product in the hands of the user or the effects of the use of abrasive cleaners will not be warranted or considered defects. The cleaning or removal of food products along with any damage caused by allowing them to build-up is not covered by any warranty. Improper installation of the in-counter model is not covered by this warranty. Also a warranty is void if the Blending Station is put into a sound reduction chamber or otherwise prevented from receiving proper cooling. In the event your Vita-Mix® appliance needs service or repair, please call Vita-Mix Service at +1(440) 235-5494 for a local distributor. In Latin America call +1(440) 235-0214 for a local distributor.



**VITA-MIX® CORPORATION**  
International Foodservice Division  
8615 Usher Road, Cleveland, Ohio 44138-2103 USA

©2001 Vita-Mix Corporation. No part of this publication may be reproduced or transmitted in any form or by any means, electronic or mechanical, including photocopy, recording or any information storage and retrieval system without the written permission of the Vita-Mix Corporation.

## Free Manuals Download Website

<http://myh66.com>

<http://usermanuals.us>

<http://www.somanuals.com>

<http://www.4manuals.cc>

<http://www.manual-lib.com>

<http://www.404manual.com>

<http://www.luxmanual.com>

<http://aubethermostatmanual.com>

Golf course search by state

<http://golfingnear.com>

Email search by domain

<http://emailbydomain.com>

Auto manuals search

<http://auto.somanuals.com>

TV manuals search

<http://tv.somanuals.com>