

**"GREAT POLARIS"
"GP-DX"
EQUATORIAL MOUNT TELESCOPE**

INSTRUCTION MANUAL



CONTENTS

"GREAT POLARIS" AND "GP-DX" EQUATORIAL MOUNTS.....	3
FOR FIRST TIME TELESCOPE USERS	4
Step 1 Proper assembly of the telescope	4
Step 2 Installation of an eyepiece	4
Step 3 First operation of the telescope	4
Step 4 Your first look	5
Step 5 Changing eyepieces	7
Step 6 Use of the finderscope	7
Step 7 Your first observation—the Moon!	8
Step 8 Observing Jupiter and Saturn	9
Step 9 Observing the Sun	9
Step 10 General Cautions	10
HOW TO SET UP THE EQUATORIAL MOUNT TELESCOPE.....	11
Roughly Aligning the Polar Axis of the Telescope	11
Using your Polar Axis Scope in the Northern Hemisphere	12
Using your Polar Axis Scope in the Southern Hemisphere	13
Aligning the Polar Axis Scope	13
HOW TO USE THE R.A. AND DECL. GRADUATION RINGS (SETTING CIRCLES)	15
HOW TO COLLIMATE THE OPTICAL SYSTEM OF A NEWTONIAN REFLECTOR	16
CAMERA ADAPTERS	17
MOTOR DRIVES	18

PRECAUTIONS

Do not touch the lens or mirror with a finger.



Never wipe the lens or mirror with a hard cloth. Use a soft silicone cloth or lens cleaning tissue.



Do not drop or subject the telescope to hard knocks.

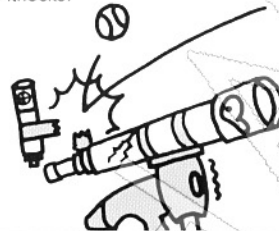

Never use the telescope in the water or in the rain.



Do not leave the telescope in a dusty place.

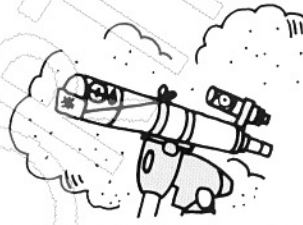

Avoid setting up the telescope at a rough place.



When storing or transporting the telescope, release the R. A. and Decl. clamps. Also remove the fine adjustment knob and handle from the mount.

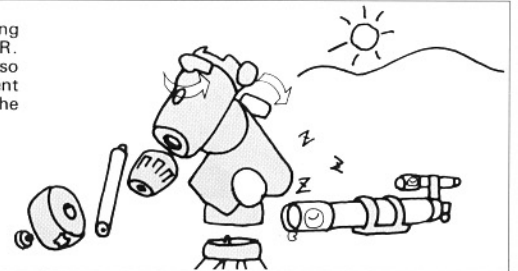

NEVER LOOK DIRECTLY AT THE SUN WITH THE TELESCOPE, FINDERSCOPE OR EYEPIECE. EYE DAMAGE AND/OR DAMAGE TO THE INSTRUMENTS MAY RESULT.



"GREAT POLARIS" AND "GP-DX" EQUATORIAL MOUNTS

"GREAT POLARIS" Mount

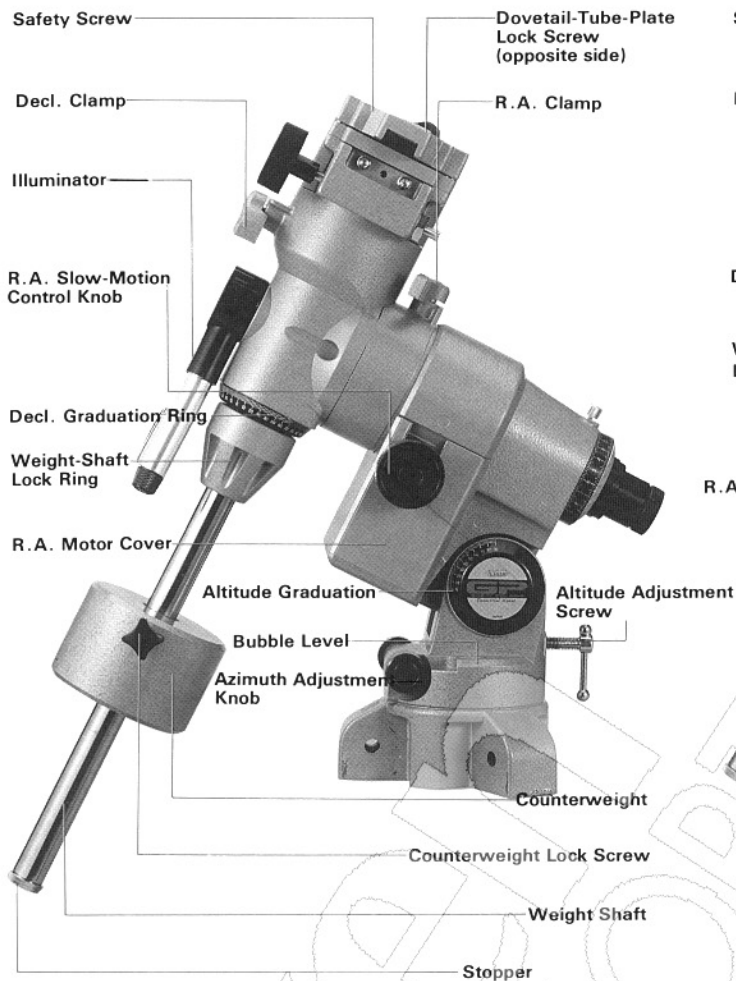

"GP-DX" Mount

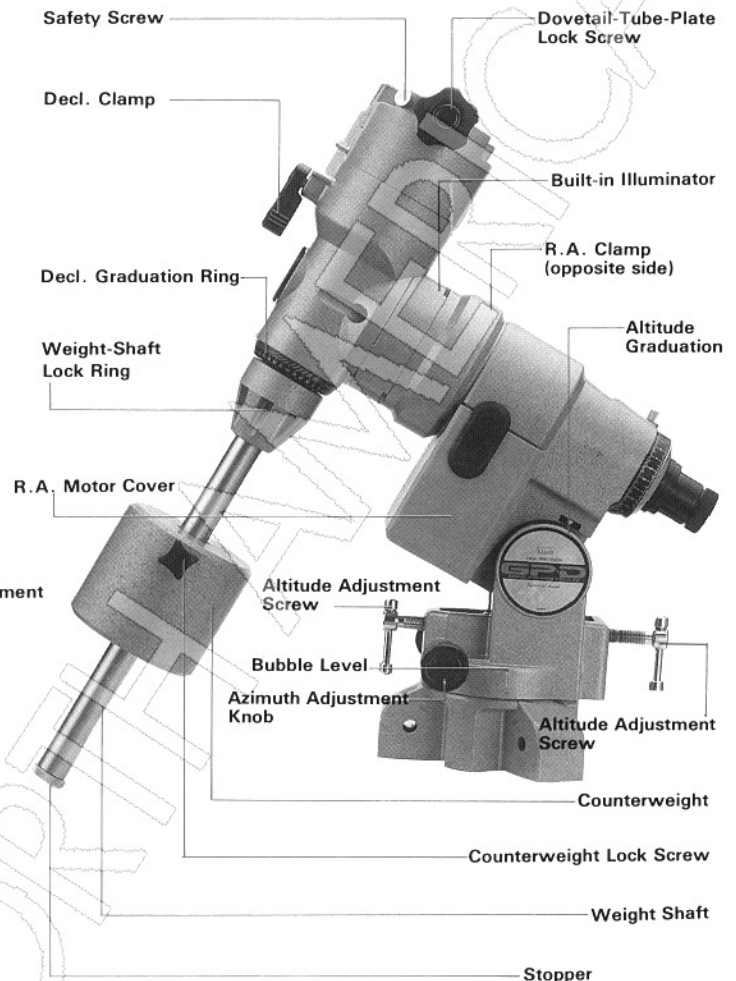

Specifications of "GREAT POLARIS" Mount

- R.A. and Decl. axes.....whole-circle micro-movement, 144-tooth worm gears
- R.A. graduation.....10' increment
- Decl. graduation.....2' increment
- R.A. slow-motion control knob.....attachable to either side, 2.5" per revolution
- Decl. slow-motion control knob.....attachable to either side, 2.5" per revolution
- Altitude adjustment.....0° to 62°, about 2° per revolution of adjustment screw
- Azimuth adjustment.....±5° about 1° per revolution of adjustment knob
- R.A. shaft.....maximum diameter 62mm
- Decl. shaft.....maximum diameter 62mm
- Weight shaft.....diameter 20mm
- Maximum loading weight.....about 7kg

Polar Alignment Graduations

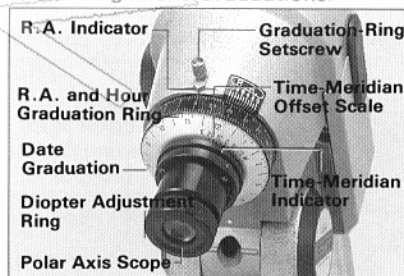

Built-in Type Illuminator

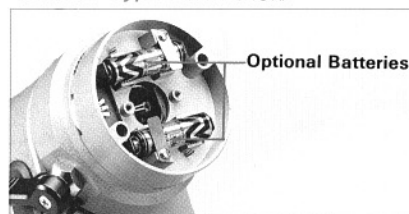

Specifications of "GP-DX" Mount

- R.A. and Decl. axes.....whole-circle micro-movement, 144-tooth worm gears
- R.A. graduation.....10' increment
- R.A. and Decl. motor drives.....±1.5x ± 2x ± 32x
- Altitude adjustment.....0° to 62°, about 2° per revolution of adjustment screw
- Azimuth adjustment.....±20°, about 1° per revolution of adjustment knob
- R.A. shaft.....maximum diameter 62mm
- Decl. shaft.....maximum diameter 62mm
- Weight shaft.....diameter 20mm
- Maximum loading weight.....about 10kg

FOR FIRST TIME TELESCOPE USERS

This manual will provide you with a better understanding of your new telescope—including its features, hardware and capabilities. As with many things, the better you understand the workings of the equipment, the more enjoyment you will get from it. This is particularly true of telescopes. So take a few moments now to become thoroughly acquainted with your new telescope. Mastering an astronomical telescope is a key to the success in astronomical observation.

Step 1 Proper assembly of the telescope

Pay particular attention to the following when assembling the telescope.

Make sure extension clamps that fix the tripod legs and a fixing knob for the mount on the underside of the tripod head are firmly fastened. They provide the stability which is so important to quality observation.

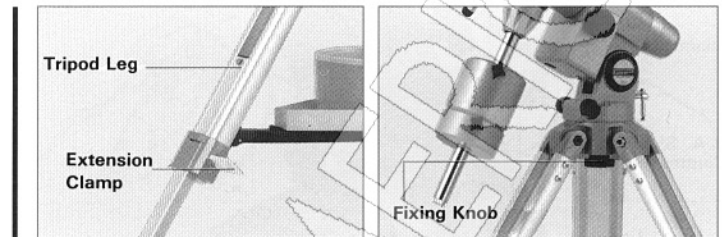

Step 2 Installation of an eyepiece

①The magnification of your telescope is determined by the eyepiece you use. It can be computed with the following formula.

$$\text{Magnification} = \frac{\text{Focal Length of Objective (mm)}}{\text{Focal Length of Eyepiece (mm)}}$$

②Read the writing on the eyepiece, and you may find characters such as "K20mm", "HM12.5mm" or "LV5mm". The first letter represents the type of eyepiece design, the number that follows represents the focal length of the eyepiece. As the number gets smaller, the magnification power of the eyepiece becomes greater, thereby allowing the viewer to observe close-up detail.

③Eyepieces are classified into three sizes of barrel diameter, 24.5mm, 31.7mm and 50.8mm.

④To set a 24.5mm, 31.7mm or 50.8mm eyepiece, insert it in a proper 24.5mm, 31.7mm or 50.8mm eyepiece adapter and securely tighten the eyepiece setscrew.

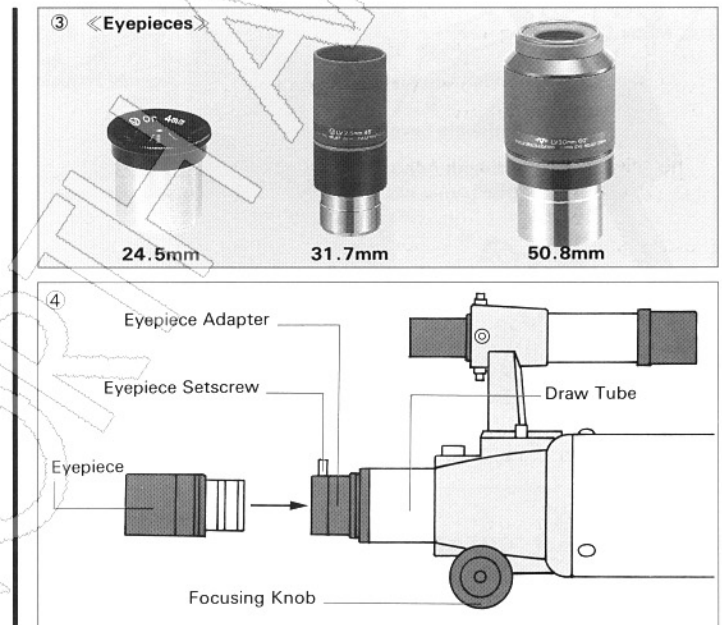

Step 3 First operation of the telescope

①Unfasten the R. A. and Decl. clamps and you can move the optical tube in a full range of motion.

CAUTION: DO NOT FORCE THE OPTICAL TUBE TO MOVE WHEN THE R. A. CLAMP OR DECL. CLAMP IS FULLY ENGAGED. THIS MAY DAMAGE PRECISION PARTS OF THE MOUNT.

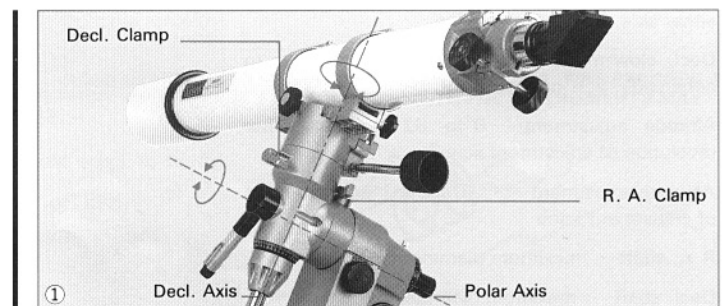

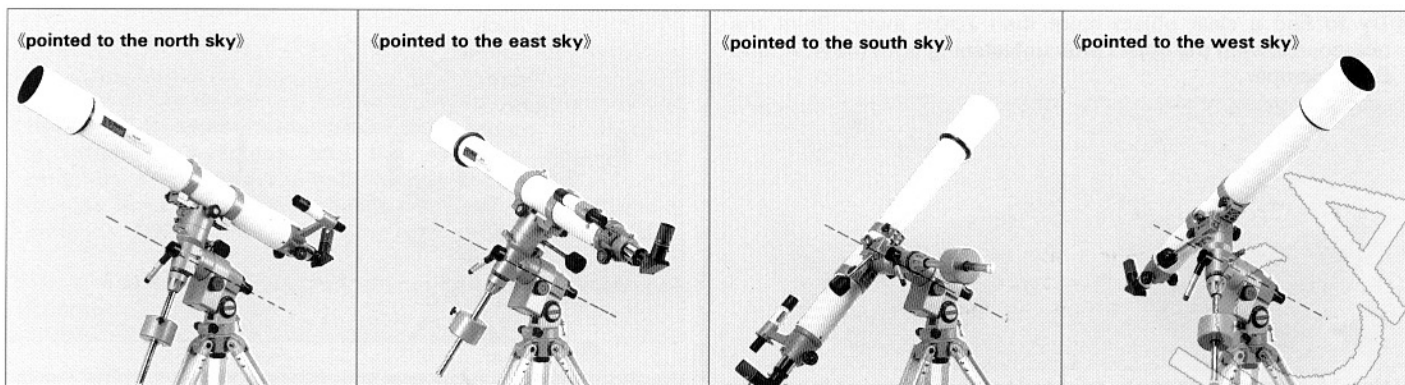

To eliminate undue stress on the mount, the telescope should be properly balanced after all the standard accessories (i. e., star diagonal, eyepiece, etc.) have been attached to the telescope. An unbalanced telescope may cause possible damage to the mount. In addition, proper balancing is crucial for accurate tracking if using a motor drive.

② To balance the mount, release the R. A. clamp and position the telescope off to one side of the mount. The counterweight bar will extend horizontally to the opposite side of the mount. Without tightening the R. A. clamp, gradually let go of the telescope to see which way it rolls. Loosen the counterweight and move it to a point where it balances the telescope. Re-tighten the counterweight.

③ The telescope should also be balanced on the declination axis to prevent any sudden motions when the Decl. clamp is released. To balance the telescope in Decl., release the R. A. clamp and rotate the telescope so that it is on one side of the mount (i. e., as described above for balancing the mount). Once this is done, lock the R. A. clamp to hold the telescope in place. Now, hold the telescope tube with one hand while releasing the Decl. clamp with the other. The telescope will most likely rotate around the declination axis. Slightly loosen the tube-ring screws and slide the telescope either forward or backward in the tube rings until it remains stationary when the Decl. clamp is released. Re-tighten the tube-ring screws.

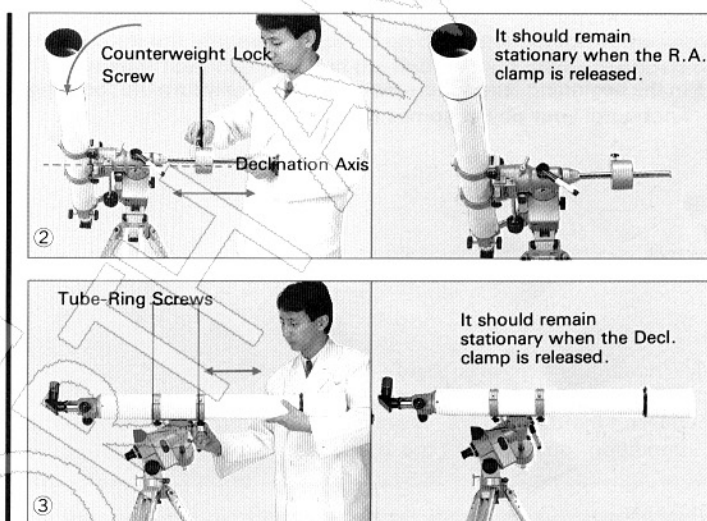

Step 4 Your first look

Your first look should be done in the daytime when it will be easier to locate adjustment knobs and clamps. This will help to familiarize you with your telescope, thus making it easier to use at night.

- ① Attach a low-power eyepiece having a long focal length. A high-power eyepiece having a short focal length will make the field of view darker and will make it more difficult to bring into focus.
- ② Remove lens caps from the objective and eyepiece.
- ③ Look through your telescope.

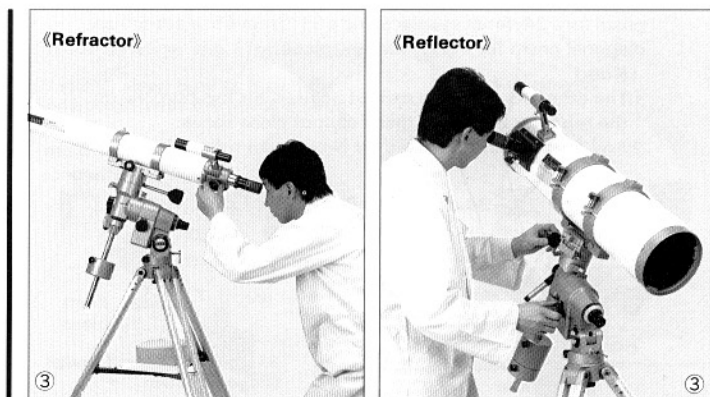

- ④ Try to find a clear object more than 200m away. Point the telescope toward the object after unfastening both the R. A. and Decl. clamps.

[Note] Eyepiece angle can be adjusted for your telescope by rotating the optical tube in the tube rings after unfastening the tube-ring screws.

- ⑤ In the beginning, everything may blur. Gradually turn the focusing knob until your object comes into sharp focus.

- ⑥ Whoops! The view is upside down, and backward! But that's OK—all astronomical telescopes operate this way as it really doesn't matter in space. There are special prisms that correct the condition, but they dim the image slightly.

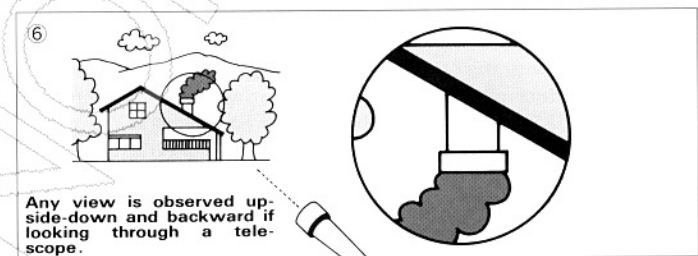
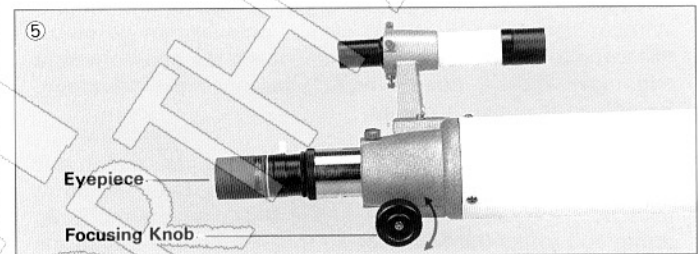
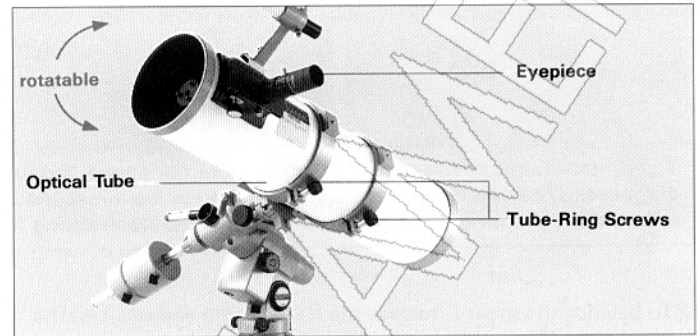
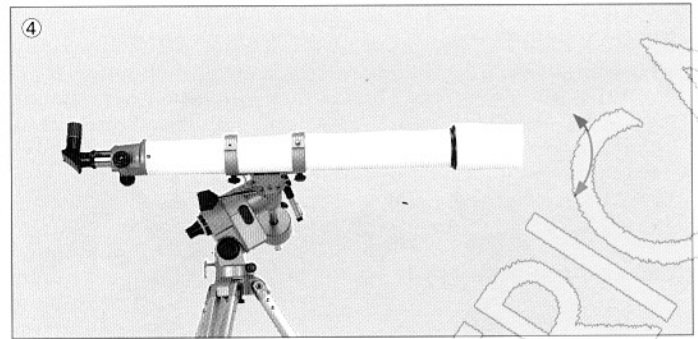

«How to use a Porro Prism or 45° Erect-Image Diagonal Prism»

To correct the upside-down view on the refractors, use a 36.4mm porro prism or 24.5mm 45° erect-image diagonal prism for a 24.5mm eyepiece and a 31.7mm 45° erect-image diagonal prism for a 31.7mm eyepiece.

[Note]

- ① The other porro prisms cannot be used for this purpose on the refractors because these cannot close focus.
- ② Any prism cannot be used on Newtonian reflectors.

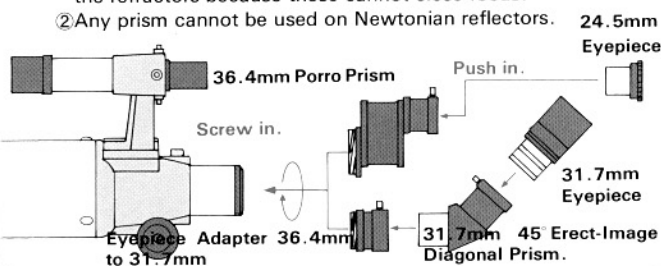

«How to use a Terrestrial Eyepiece»

Although the upside-down view can be corrected with a terrestrial eyepiece, it makes the field of view narrow. Also, the magnification power of the terrestrial eyepiece cannot be changed. The method of calculating the magnification of the terrestrial eyepiece is the same as those of other eyepieces.

[Note] The terrestrial eyepiece cannot be used on Newtonian reflectors.

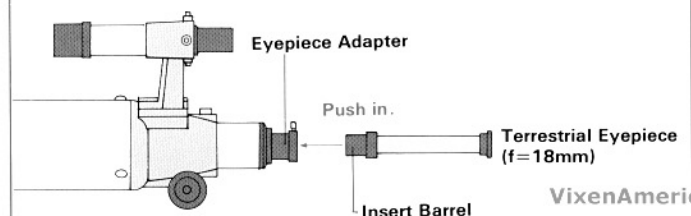

VixenAmerica.com

Step 5 Changing eyepieces

① To remove the eyepiece, loosen the eyepiece setscrew and slide the eyepiece out. Slide the chrome barrel of a higher-power eyepiece into the eyepiece adapter and re-tighten the setscrew to hold the eyepiece in place.

[Note] As the high-power eyepiece makes it more difficult to bring into focus, turn the focusing knob slowly and carefully.

② The size of the image you now observe through the telescope is larger.

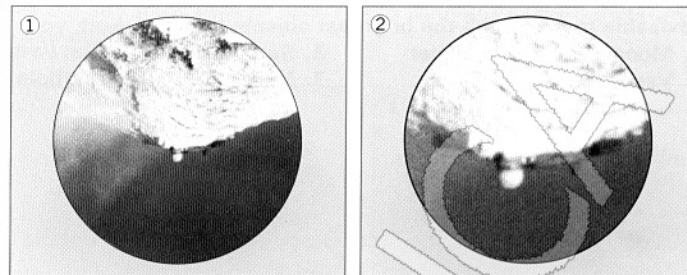

Step 6 Use of the finderscope

How does a terrestrial view look through a finder? Upside-down and backwards – just as through the main telescope. However, there are points of slight difference.

(a) A crosshair reticle is seen. This is for pinpoint accuracy.

(b) A wider view is seen than when the main telescope is used.

The finderscope is simply to help you easily locate objects and bring them within the view of the main telescope. As your telescope – even on “low” power – is still extremely powerful, finding the objects can be difficult. This is why telescopes are equipped with finderscopes.

Prior to serious observations, make sure both the telescope and the finderscope are aligned – targeted on the same object. If the same object is not centered in the crosshairs of the finderscope and centered in the main telescope, adjust the finderscope, using the position setscrews.

«Aligning the Finderscope»

① Attach a low-power eyepiece to the eyepiece adapter of your telescope.

② Point the telescope at a clear object about 1km away and center it in the field of view.

③ Bring the same object to the center of the crosshairs of the finderscope, using the position setscrews.

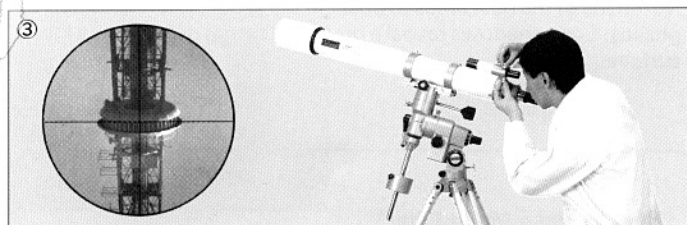
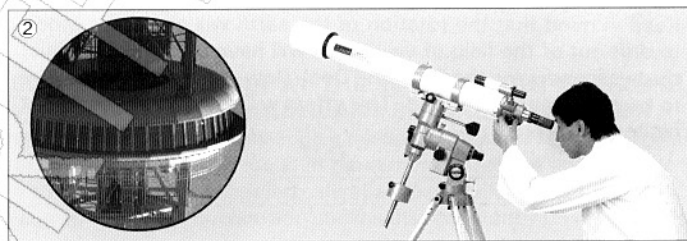

«How to align the Finderscope»

① and ② show how to fasten the finderscope with the position setscrews.

Position Setscrews
(3 pieces)



Bolt
Nut

①

②

Turn and fix the nut.

③

④

⑤

⑥

⑦

⑧

⑨

⑩



Step 7 Your first observation—the Moon !

Now, you are ready to point the telescope toward celestial objects! Although observation may start with any celestial object, it is advisable to start with the brightest objects first and work your way to fainter ones. Here is a good beginner's viewing order:

1. Moon
2. Jupiter
3. Saturn
4. Sun (with proper filter)
5. Venus
6. Mars
7. Mercury
8. Multiple Stars
9. Nebulae and Star Clusters

Now, let's look at the Moon.

① Locate the Moon in the finderscope and center it on the crosshairs.

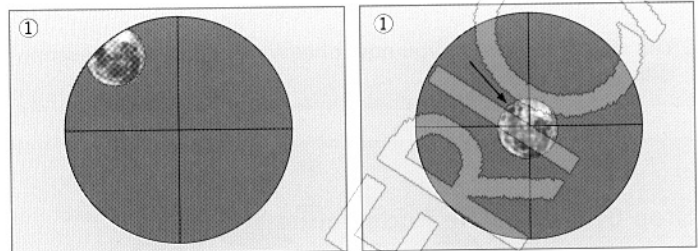

② Put a low power eyepiece in the telescope. At low power (about 50 magnification), you will be able to see the entire lunar disk at one time.

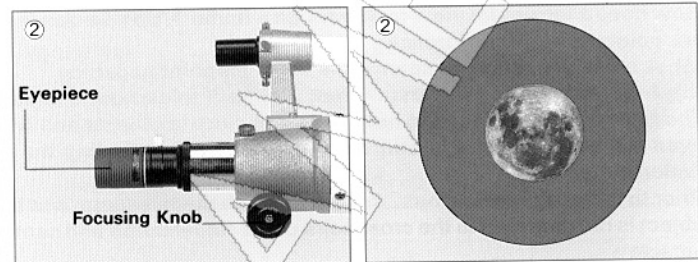

③ If you later desire a close-up of a lunar region, use a higher power eyepiece.

④ Keep in mind that the rotation of the earth will cause the Moon to drift out of the field of view. You will have to manually adjust the telescope using the R. A. and Decl. slow-motion control knobs to keep the Moon centered. This effect will be more noticeable at higher power.

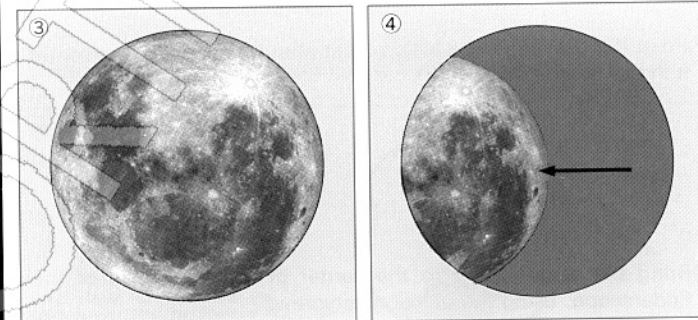

[Note] One of the best times to observe the Moon is during its partial phases. Long shadows reveal a great amount of detail on the lunar surface.

«How to use a Moon Filter»

If you find that the lunar image is too bright for comfortable viewing, attach a moon filter to the eyepiece. It will reduce the brightness and, at the same time, increase contrast on the lunar surface.

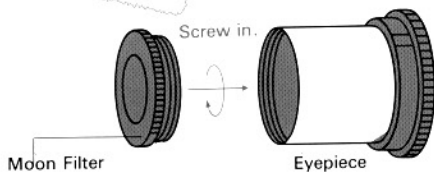

«How to use a Diagonal Prism»

A diagonal prism lets you view objects at a right-angle (90°) from the direction where the refractor telescope is pointing, thereby allowing comfortable viewing when the telescope is pointed at or near the zenith (directly overhead). Newtonian reflectors do not require such a diagonal prism since objects are always viewed from the side of the main tube of the telescope.

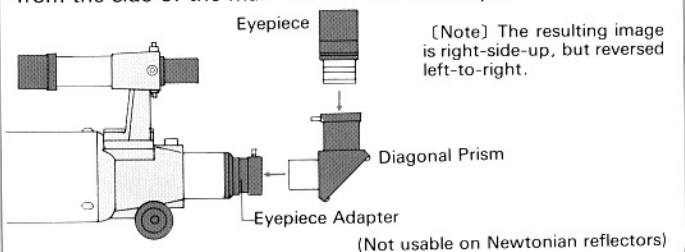

Step 8 Observing Jupiter and Saturn

Planets such as Jupiter and Saturn appear to steadily move across the sky from east to west. They appear as bright stars. Most astronomy publications tell where the planets can be found in the sky each month.

① Use a low power eyepiece—about 50 magnification. Jupiter will be seen like a small disk. You will also be able to see four moons of Jupiter. (These satellites are not always visible because their orbits carry them behind the planet.) Saturn, with its beautiful rings, is easily visible.

② When seeing conditions are good (the atmosphere is steady), raise the magnification greater than 100. You will be able to see the cloud belts of Jupiter and the great Red Spot (if it is visible at the time you are observing). The rings of Saturn and even the small dark division (Cassini's Division) in the rings will be visible.

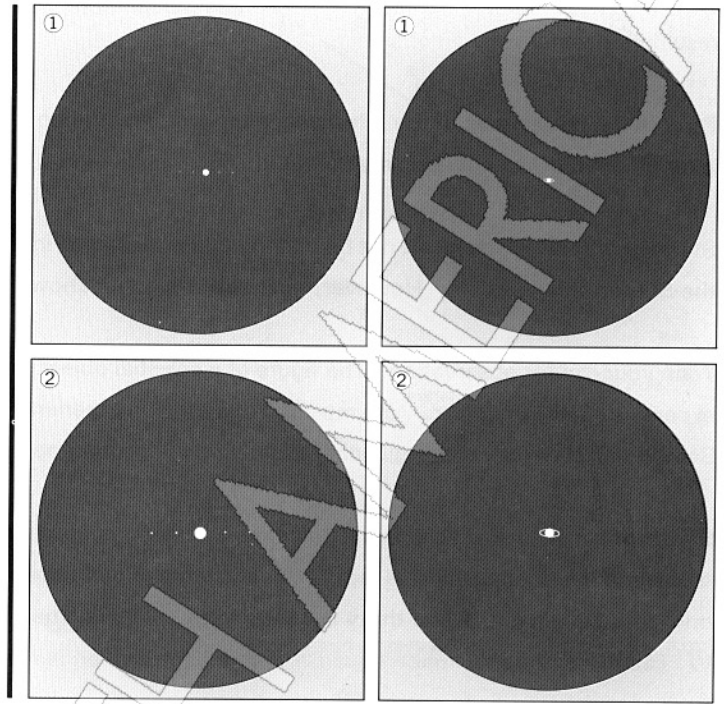

Step 9 Observing the Sun

CAUTION: NEVER POINT A TELESCOPE AT THE SUN AND NEVER LOOK DIRECTLY AT THE SUN WITHOUT TAKING ALL PROPER PRECAUTIONS. READ THIS PARAGRAPH CAREFULLY BEFORE UNDERTAKING ANY SOLAR OBSERVATION.

All telescopes collect light—much more light than the human eye. Therefore, viewing the Sun through a telescope must only be undertaken carefully, with all proper precautions observed. Failure to take the proper precautions may result in permanent blindness and damage to your telescope. To observe the Sun safely, always fit the eyepiece with a sun filter. In addition, always place the objective cap on the telescope with only the small solar aperture open. You will enjoy seeing sun spots—huge nuclear sun storms that constantly change position and size.

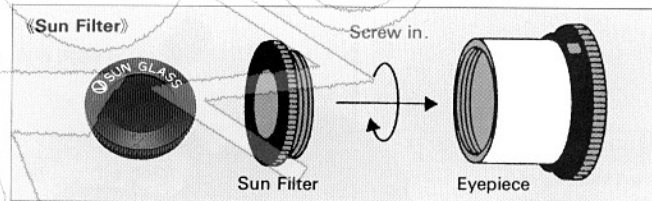

«Using the Sun Diagonal Prism»

When the sun filter is used with the telescope for long observation, it may sometimes break from the heat. If a sun diagonal prism is added, it exhausts 96% of sunlight and heat outside, so that only the remaining 4% of sunlight is used to observe the Sun, allowing long observation with safety. A special sun filter to be screwed in the eyepiece belongs to the sun diagonal prism. Use the special sun filter together with the sun diagonal prism. Its colour density is somewhat lighter than the ordinary sun filter. Only when using the sun diagonal prism and the special sun filter, take off the objective lens cap to expand the effective diameter of the objective lens and to enhance its resolving power.

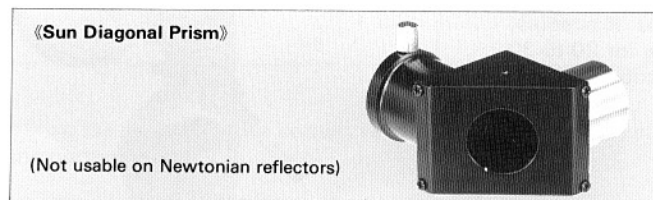

(Not usable on Newtonian reflectors)

Step 10 General Cautions

- ① Try never to view through glass windows when observing. Clear as window glass seems, compared to the fine optical glass of your telescope, it produces very distorted images. If the observation is undertaken through an open window, air movement through the window (owing to the temperature difference between the inside and outside air) may cause image instability, resulting in distortion.
- ② Be sure the optical axis of the telescope is centered. If the optical axis of the telescope is out of center, the image of an object is lengthened or is unnecessarily coloured.
- ③ Stars other than the Sun can not be observed in an enlarged image, because they are very far from the earth as compared with the Sun or other planets. However, your telescope can show you millions of stars not visible to the naked eye.
- ④ Train your eye for observation. The figure of a celestial object observed through a telescope looks different depending upon the experience of the observer. With repeated observation experience, you will begin to see objects that you could not earlier observe. Sometimes averted vision—glancing slightly away from an object will help you see more detail.
- ⑤ Stars appear to move very fast. Because a telescope tracks an object at high magnification for observation, the apparent movement of an object seems rapid. For instance, when observing Jupiter at a magnification of 100, the moving planet takes only about one minute and thirty seconds from the time when it first appears in the eyepiece to the time when it disappears. We call this apparent motion because most of the motion is really the earth rotating under us!

«Newtonian Reflector»

Secondary-Mirror Support Arm and Adjustment Screws

The secondary mirror is of critical importance to the proper operation of your telescope. Never turn the adjustment screws except when you correct the optical axis.

When observing an object soon after taking the telescope outside, you can sometimes see the object appear to fluctuate. This is because warm air and cold air are mixing in the tube. If possible, expose the telescope to the open air for 20 to 30 minutes before observing, so that tube temperature stabilizes.



Primary-Mirror Cell

There are three pairs of screws on the back of the primary-mirror cell. Never turn these screws except when you correct the optical axis.

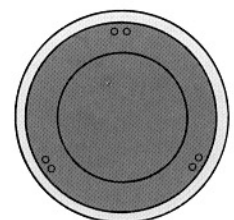

Free Manuals Download Website

<http://myh66.com>

<http://usermanuals.us>

<http://www.somanuals.com>

<http://www.4manuals.cc>

<http://www.manual-lib.com>

<http://www.404manual.com>

<http://www.luxmanual.com>

<http://aubethermostatmanual.com>

Golf course search by state

<http://golfingnear.com>

Email search by domain

<http://emailbydomain.com>

Auto manuals search

<http://auto.somanuals.com>

TV manuals search

<http://tv.somanuals.com>