

VIZIO

MODELS

E191VA  
E221VA  
E261VA

# USER GUIDE

INSTALLING YOUR NEW TV

CONTROLS & CONNECTIONS

CONNECTING YOUR DEVICES

USING THE ON-SCREEN MENU

USING THE USB MEDIA PLAYER

TROUBLESHOOTING & SUPPORT

SPECIFICATIONS, SAFETY & LEGAL



This product qualifies for ENERGY STAR in the "factory default" setting and this is the setting in which power savings will be achieved. Changing the factory default picture settings or enabling other features will increase power consumption that could exceed the limits necessary to qualify for ENERGY STAR rating.



SRS TruSurround HD and SRS TruVolume are trademarks of SRS Labs, Inc. TruSurround HD and TruVolume technologies are incorporated under license from SRS Labs, Inc.



Manufactured under license from Dolby Laboratories. Dolby and the double-D symbol are trademarks of Dolby Laboratories.



HDMI, the HDMI logo and High-Definition Multimedia Interface are trademarks or registered trademarks of HDMI Licensing LLC.

## THANK YOU FOR CHOOSING VIZIO

And congratulations on your new VIZIO HDTV.

To get the most out of your new VIZIO product, read these instructions before using your product and retain them for future reference. Be sure to inspect the package contents to ensure there are no missing or damaged parts.

## PRODUCT REGISTRATION

To purchase or inquire about accessories and installation services for your VIZIO product, visit our website at [www.VIZIO.com](http://www.VIZIO.com) or call toll free at (877) 878-4946.

We recommend that you either:

- Register your VIZIO product at [www.VIZIO.com](http://www.VIZIO.com)
- Complete and mail the enclosed registration card

## Extended Warranties

For peace of mind, and to protect your investment beyond the standard warranty, VIZIO offers on-site extended warranty service plans. These plans provide additional coverage during the standard warranty period. To purchase an extended warranty service plan, visit [www.VIZIO.com](http://www.VIZIO.com).

## WHEN READING THIS MANUAL



When you see this symbol, please read the accompanying important warning or notice. It is intended to alert you to the presence of important operating instructions.



When you see this symbol, please read the accompanying helpful tip.

## IMPORTANT SAFETY INSTRUCTIONS

Your TV is designed and manufactured to operate within defined design limits. Misuse may result in electric shock or fire. To prevent your TV from being damaged, the following instructions should be observed for the installation, use, and maintenance of your TV. Read the following safety instructions before operating your TV. Keep these instructions in a safe place for future reference.

- To reduce the risk of electric shock or component damage, switch off the power before connecting other components to your TV.
- Read these instructions.
- Keep these instructions.
- Heed all warnings.
- Follow all instructions.
- Do not use this apparatus near water.
- Clean only with a dry cloth.
- Do not block any ventilation openings. Install in accordance with the manufacturer's instructions.
- Do not install near any heat sources such as radiators, heat registers, stoves, or other apparatus (including amplifiers) that produce heat.
- Do not defeat the safety purpose of the polarized or grounding-type plug. A polarized plug has two blades and a third grounding prong. The wide blade or the third prong are provided for your safety. If the provided plug does not fit into your outlet, consult an electrician for replacement of the obsolete outlet.
- Protect the power cord from being walked on or pinched, particularly at plugs, convenience receptacles, and the point where they exit from the apparatus.
- Only use attachments/accessories specified by the manufacturer.
- Use only with the cart, stand, tripod, bracket, or table specified by the manufacturer, or sold

with the apparatus. When a cart is used, use caution when moving the cart/apparatus combination to avoid injury from tip-over.



- Unplug this apparatus during lightning storms or when unused for long periods of time.
- Refer all servicing to qualified service personnel. Servicing is required when the apparatus has been damaged in any way, such as when the power-supply cord or plug is damaged, liquid has been spilled or objects have fallen into the apparatus, the apparatus has been exposed to rain or moisture, does not operate normally or has been dropped.
- Unplug the power cord before cleaning your TV.
- When moving your TV from an area of low temperature to an area of high temperature, condensation may form in the housing. Wait before turning on your TV to avoid causing fire, electric shock, or component damage.
- A distance of at least three feet should be maintained between your TV and any heat source, such as a radiator, heater, oven, amplifier etc. Do not install your TV close to smoke. Operating your TV close to smoke or moisture may cause fire or electric shock.
- Slots and openings in the back and bottom of the cabinet are provided for ventilation. To ensure reliable operation of your TV and to protect it from overheating, be sure these openings are not blocked or covered. Do not place your TV in a bookcase or cabinet unless proper ventilation is provided.
- Never push any object into the slots and openings on your TV cabinet. Do not place any objects on the top of your TV. Doing so could short circuit parts causing a fire or electric shock. Never spill liquids on your TV.
- Your TV should be operated only from the type of power source indicated on the label. If you are not sure of the type of power supplied to your home, consult your dealer or local power company.

- Do not apply pressure or throw objects at your TV. This may compromise the integrity of the display. The manufacturer's warranty does not cover user abuse or improper installations.
- The power cord must be replaced when using different voltage than the voltage specified. For more information, contact your dealer.
- Your TV is equipped with a three-pronged grounded plug (a plug with a third grounding pin). This plug will fit only into a grounded power outlet. This is a safety feature. If your outlet does not accommodate the three-pronged, have an electrician install the correct outlet, or use an adapter to ground your TV safely. Do not defeat the safety purpose of the grounded plug.
- When connected to a power outlet, power is always flowing into your TV. To totally disconnect power, unplug the power cord.
- The lightning flash with arrowhead symbol within an equilateral triangle is intended to alert the user to the presence of un-isolated, dangerous voltage within the inside of your TV that may be of sufficient magnitude to constitute a risk of electric shock to persons.
- Do not overload power strips and extension cords. Overloading can result in fire or electric shock.
- The wall socket should be installed near your TV and easily accessible.
- Only power of the marked voltage can be used for your TV. Any other voltage than the specified voltage may cause fire or electric shock.
- Do not touch the power cord during lightning. To avoid electric shock, avoid handling the power cord during electrical storms.
- Unplug your TV during a lightning storm or when it will not be used for long period of time. This will protect your TV from damage due to power surges.
- Do not attempt to repair or service your TV yourself.



Opening or removing the back cover may expose you to high voltages, electric shock, and other hazards. If repair is required, contact your dealer and refer all servicing to qualified service personnel.

- **WARNING:** Keep your TV away from moisture. Do not expose your TV to rain or moisture. If water penetrates into your TV, unplug the power cord and contact your dealer. Continuous use in this case may result in fire or electric shock.
- Do not use your TV if any abnormality occurs. If any smoke or odor becomes apparent, unplug the power cord and contact your dealer immediately. Do not try to repair your TV yourself.
- Avoid using dropped or damaged appliances. If your TV is dropped and the housing is damaged, the internal components may function abnormally. Unplug the power cord immediately and contact your dealer for repair. Continued use of your TV may cause fire or electric shock.
- Do not install your TV in an area with heavy dust or high humidity. Operating your TV in environments with heavy dust or high humidity may cause fire or electric shock.
- Follow instructions for moving your TV. Ensure that the power cord and any other cables are unplugged before moving your TV.
- When unplugging your TV, hold the AC/DC power adapter, not the cord. Pulling on the power cord may damage the wires inside the cord and cause fire or electric shock. When your TV will not be used for an extended period of time, unplug the power cord.
- To reduce risk of electric shock, do not touch the connector with wet hands.
- Insert batteries in accordance with instructions. Incorrect polarities may cause the batteries to leak which can damage the remote control or injure the operator. Do not expose batteries to excessive heat such as sunshine, fire or the like.

- If any of the following occurs, contact the dealer:
  - The power cord fails or frays.
  - Liquid sprays or any object drops into your TV.
  - Your TV is exposed to rain or other moisture.
  - Your TV is dropped or damaged in any way.
  - The performance of your TV changes substantially.
- This apparatus shall not be exposed to dripping or splashing and no objects fill with liquids, such as vases, shall be placed on the apparatus.
- The mains plug or appliance coupler is used as the disconnect device, the disconnect device shall remain readily operable.
- **CAUTION** - These servicing instructions are for use by qualified service personnel only. To reduce the risk of electric shock, do not perform any servicing other than that contained in the operating instructions unless you are qualified to do so.



The lightning flash with arrowhead symbol within an equilateral triangle is intended to alert the user to the presence of uninsulated **DANGEROUS VOLTAGE** within the product's enclosure that may be of sufficient magnitude to constitute a risk of electrical shock to persons.

## DTV TRANSITION ADVISORY

The nationwide switch to digital television broadcasting was complete on June 12, 2009. Analog-only television sets that receive TV programming through an antenna now need a converter box to continue to receive over-the-air TV. Watch your local stations to find out when they will turn off their analog signal and switch to digital-only broadcasting. Analog-only TVs should continue to work as before to receive low power, Class A or translator television stations and with cable and satellite TV services, gaming consoles, VCRs, DVD players, and similar products.

For additional information, please contact the parties listed below, as appropriate:

### **FCC (US Federal Communications Commission)**

Web: [www.fcc.gov](http://www.fcc.gov)

Phone: 1-888-CALL-FCC (1-888-225-5322)

TTY: 1-888-TELL-FCC (1-888-835-5322)

Fax: 1-866-418-0232

E-mail: [fccinfo@fcc.gov](mailto:fccinfo@fcc.gov)

### **NTIA (National Telecommunications and Information Administration)**

Web: [www.ntia.doc.gov](http://www.ntia.doc.gov)

Phone: 1-888-DTV-2009 (1-888-388-2009)

### **List of US Television Stations**

[www.high-techproductions.com/usTVstations.htm](http://www.high-techproductions.com/usTVstations.htm)



Your TV comes with a built-in tuner capable of processing digital broadcasts. No extra converter box is needed.

## TELEVISION ANTENNA CONNECTION PROTECTION

If an outside antenna/satellite dish or cable system is to be connected to the TV, make sure that the antenna or cable system is electrically grounded to provide some protection against voltage surges and static charges.

Article 810 of the National Electrical Code, ANSI/NFPA 70, provides information with regard to proper grounding of the mast and supporting structure, grounding of the lead-in wire to an antenna discharge unit, size of the grounding conductors, location of antenna discharge unit, connection to grounding electrodes, and requirements of the grounding electrode.

## Lightning Protection

For added protection of the TV during a lightning storm or when it is left unattended or unused for long periods of time, unplug the TV from the wall outlet and disconnect the antenna or cable system.

## Power Lines

Do not locate the antenna near overhead light or power circuits, or where it could fall into such power lines or circuits. Remember, the screen of the coaxial cable is intended to be connected to earth in the building installation.

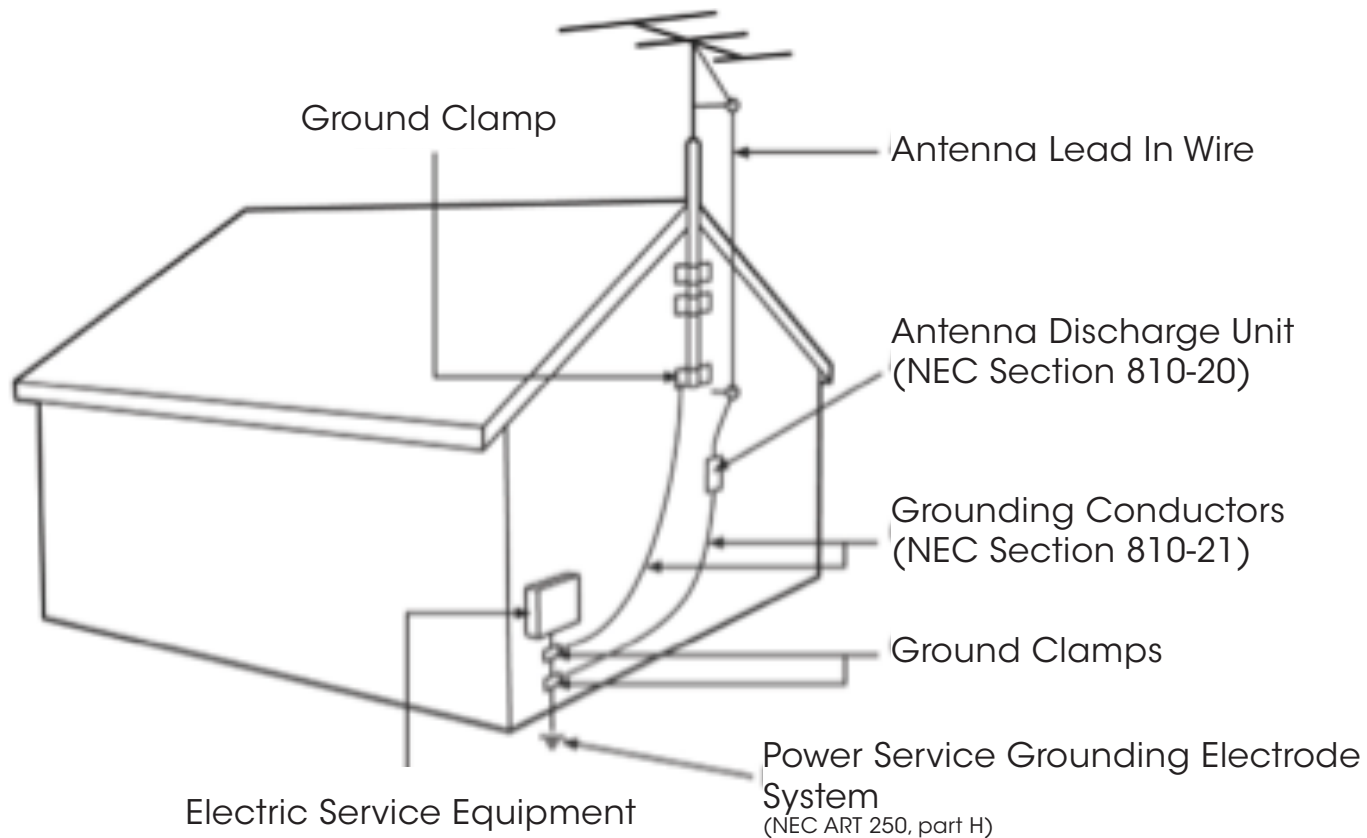

# Table of Contents

Installing the TV .....	3	Adjusting the Picture Settings .....	20
Inspecting the Package Contents .....	3	Adjusting the Noise Reduction Setting.....	21
Installing the TV.....	3	Enabling or Disabling Fast Response .....	22
Installing the TV Stand .....	3	Enabling or Disabling the Ambient Light Sensor.....	22
Installing the Base.....	4	Resetting the Picture Settings .....	23
Removing the Base .....	4	Adjusting the Audio Settings .....	23
Installing the TV on a Wall.....	5	Enabling or Disabling SRS TruSurroundHD .....	23
Controls and Connections .....	6	Enabling or Disabling SRS TruVolume .....	24
Rear Panel (E191VA & E221VA) .....	6	Adjusting the Equalizer Settings .....	24
Rear Panel (E261VA) .....	7	Adjusting Bass and Treble Levels.....	25
Side Panel .....	8	Adjusting the Speaker Balance.....	25
Front Panel.....	9	Enabling or Disabling the Built-In Speakers.....	26
Remote Control .....	10	Changing the Audio Language.....	26
Replacing the Batteries .....	11	Resetting the Audio Settings.....	27
Connecting Your Devices.....	12	Changing the TV Settings.....	27
Connecting A Device (E191VA & E221VA).....	12	Customizing and Removing Input Names .....	27
Connecting A Device (E261VA) .....	13	Customizing Input Names .....	27
Connecting A PC.....	14	Removing Unused Inputs from the Input List .....	28
Completing the First-Time Setup.....	15	Setting Up Channels.....	28
Using the On-Screen Menu .....	17	Changing the Signal Source .....	28
Navigating the On-Screen Menu .....	17	Customizing the Master Channel List.....	29
Changing the Input Source .....	18	Scanning for New or Additional Channels.....	29
Changing the Screen Aspect Ratio .....	18	Scanning for Channels.....	30
Setting Up Closed Captioning .....	19	Customizing Channel Names.....	30
Changing the Appearance of Digital Closed Captions .....	19	Changing the On-Screen Menu Language.....	31
Activating the Sleep Timer.....	20	Setting the TV's Date and Time .....	31
Setting the Auto Power Off Feature.....	20	Setting the Time Zone .....	31
		Adjusting the Time for Daylight Savings .....	32
		Enabling or Disabling Automatic Date and Time Updates.....	32

Setting the Date and Time .....	32
Adjusting the TV Settings for Use with A PC.....	33
Setting the Parental Controls.....	33
Enabling or Disabling Program Ratings.....	33
Locking and Unlocking Channels .....	33
Blocking and Unblocking Content by Rating.....	34
Changing the Parental Control Passcode .....	34
Resetting the Content Locks.....	34
Adjusting the CEC Settings.....	35
Viewing System Info and Resetting to Factory Defaults.....	35
Displaying System Information .....	35
Restoring the TV to the Factory Default Settings .....	36
Restarting the Setup App.....	36
<b>Using the USB Media Player .....</b>	<b>37</b>
Using the USB Media Player.....	37
Connecting a USB Thumb Drive to the TV.....	37
Viewing a USB Photo Slideshow.....	37
<b>Troubleshooting &amp; Technical Support.....</b>	<b>39</b>
<b>Specifications .....</b>	<b>43</b>
<b>Limited Warranty.....</b>	<b>44</b>
<b>Legal &amp; Compliance.....</b>	<b>45</b>

## INSPECTING THE PACKAGE CONTENTS

Before installing your new TV, take a moment to inspect the package contents. Use the images below to ensure nothing is missing or damaged.



VIZIO LCD HDTV



Quick Start Guide



Remote Control with Batteries

Package Contents

## INSTALLING THE TV

After removing the TV from the box and inspecting the package contents you can begin installing the TV. Your TV can be installed in two ways:

- On a flat surface, using the included stand
- On a wall, using a VESA-standard wall mount (not included)

### Installing the TV Stand

Your TV includes a stand designed to support the weight of the TV and keep it from falling over. However, the TV can still fall over if:

- It is placed on an uneven, unstable, or non-level surface
- It is pushed, pulled, or otherwise improperly moved
- If an earthquake occurs and the TV is not properly secured



TV on Stand

## Installing the Base

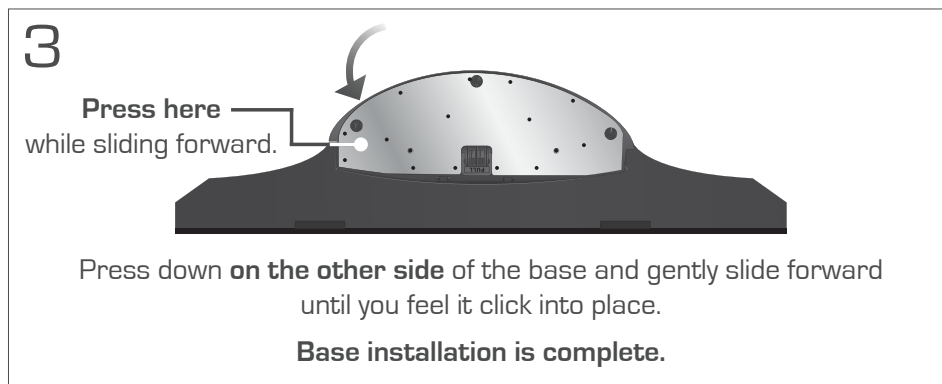
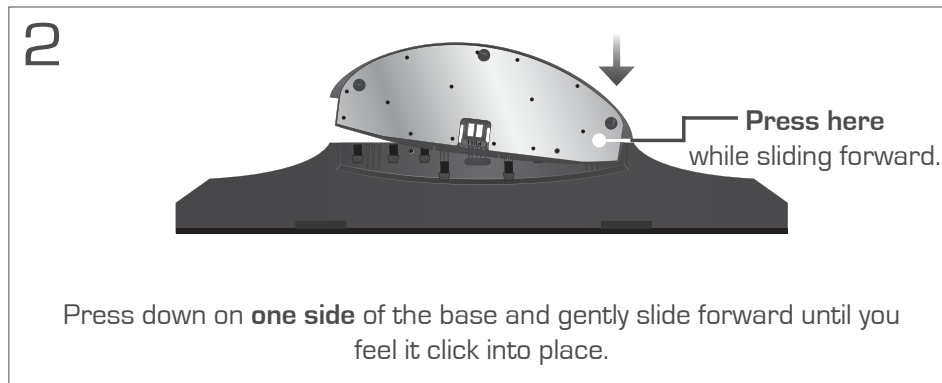
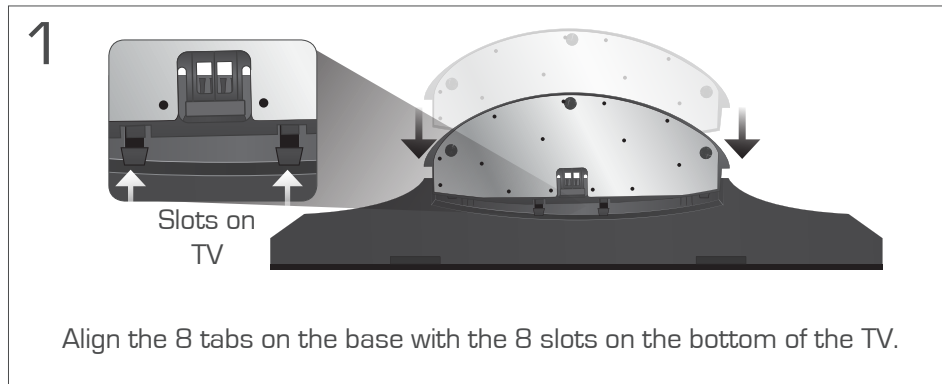

## Removing the Base

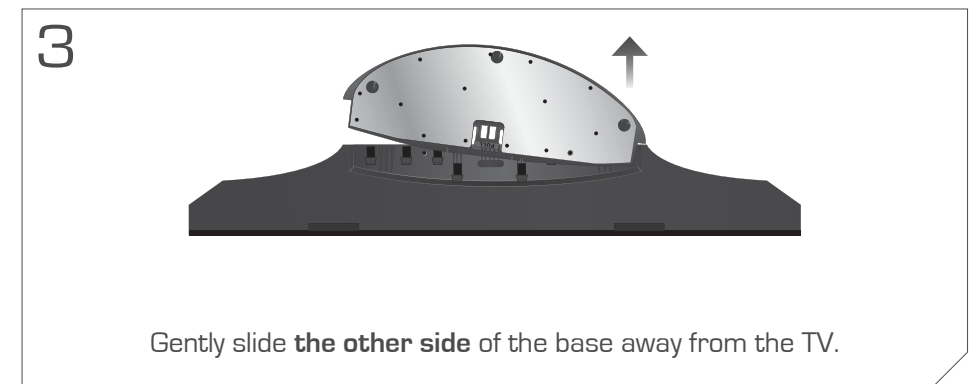
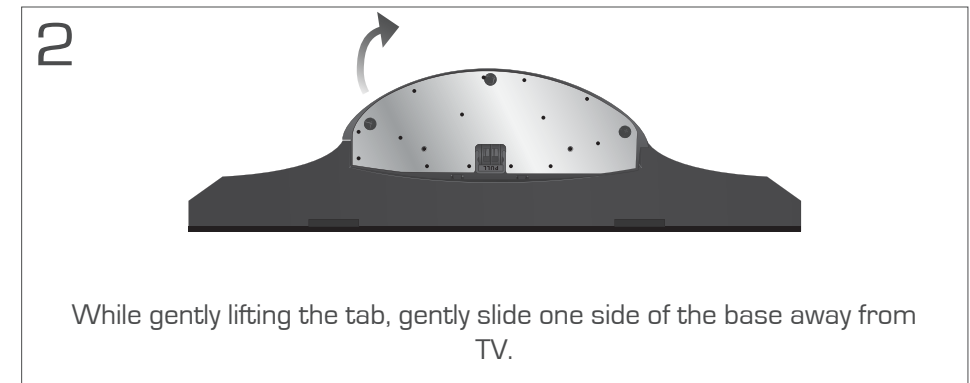
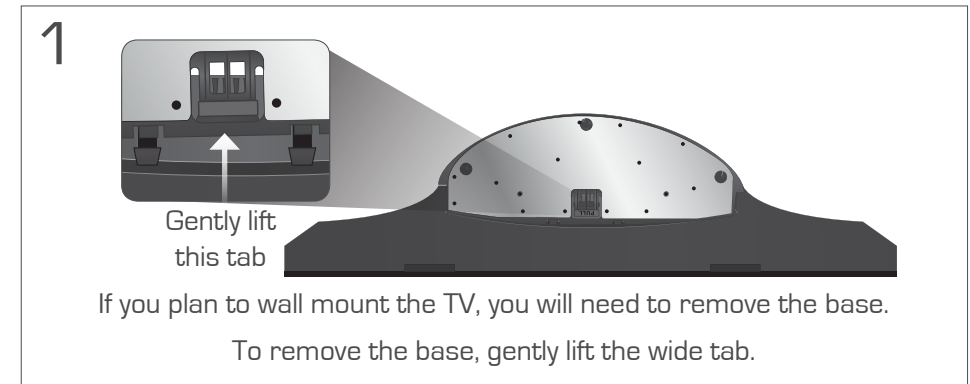



## Installing the TV on a Wall

To mount your TV on a wall, you will need a wall mount. Consult the information below to find the appropriate mount for your TV model:



Installing a TV on a wall requires lifting. To prevent injury or damage to the TV, ask someone to help you.

	E191VA	E221VA	E261VA
Screw Size:	M4	M4	M4
Screw Length:	10mm	10mm	10mm
Screw Pitch:	0.7mm	0.7mm	0.7mm
Hole Pattern:	75mm (V) x 75mm (H)	75mm (V) x 75mm (H)	100mm (V) x 100mm (H)

Be sure the mount you choose is capable of supporting the weight of the TV. After you have determined that you have the correct mount for your TV, you can begin the installation.

To install your TV on a wall:

1. Disconnect any cables connected to your TV.
2. Place the TV face-down on a clean, flat, stable surface. Be sure the surface is clear of debris that can scratch or damage the TV.
3. Remove the base by loosening and removing the screws.
4. Attach your TV and wall mount to the wall, carefully following the instructions that came with your mount.

Use only with a UL-listed wall mount bracket rated for the weight/load of this TV. See *Appendix B - Specifications* for the weight of this TV.

## REAR PANEL (E191VA & E221VA)

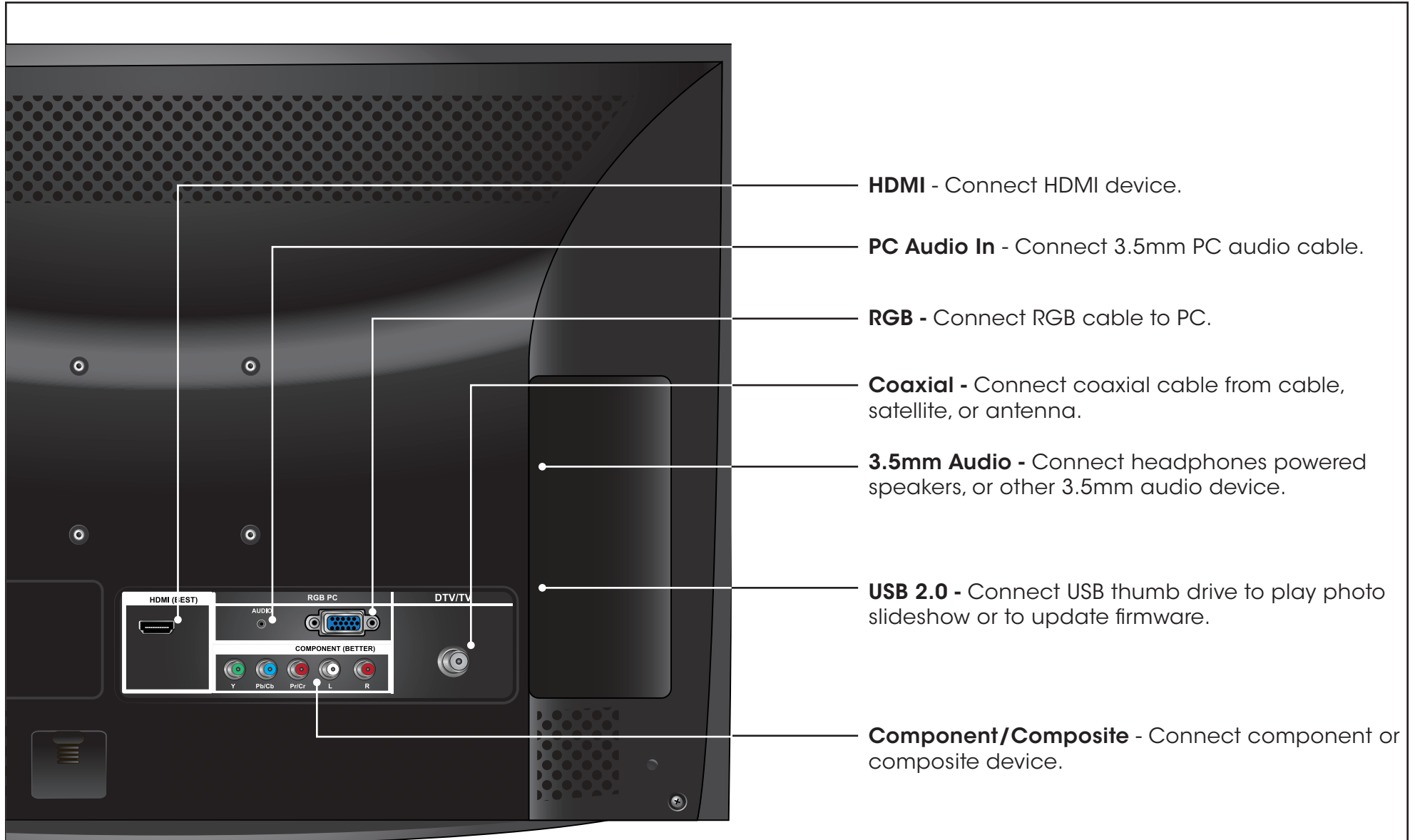

Rear Panel - E191VA & E221VA

## REAR PANEL (E261VA)

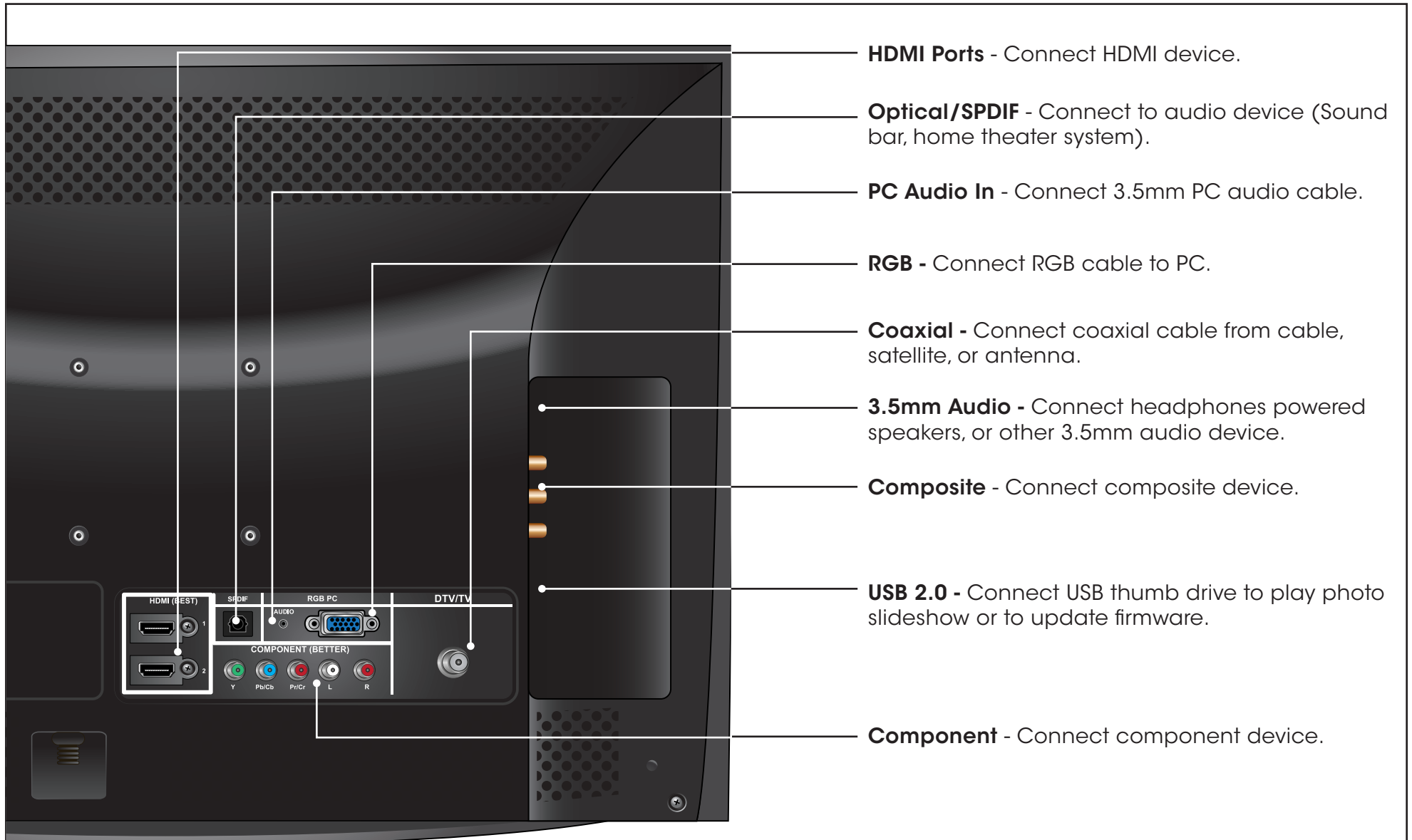

Rear Panel - E261VA

## SIDE PANEL

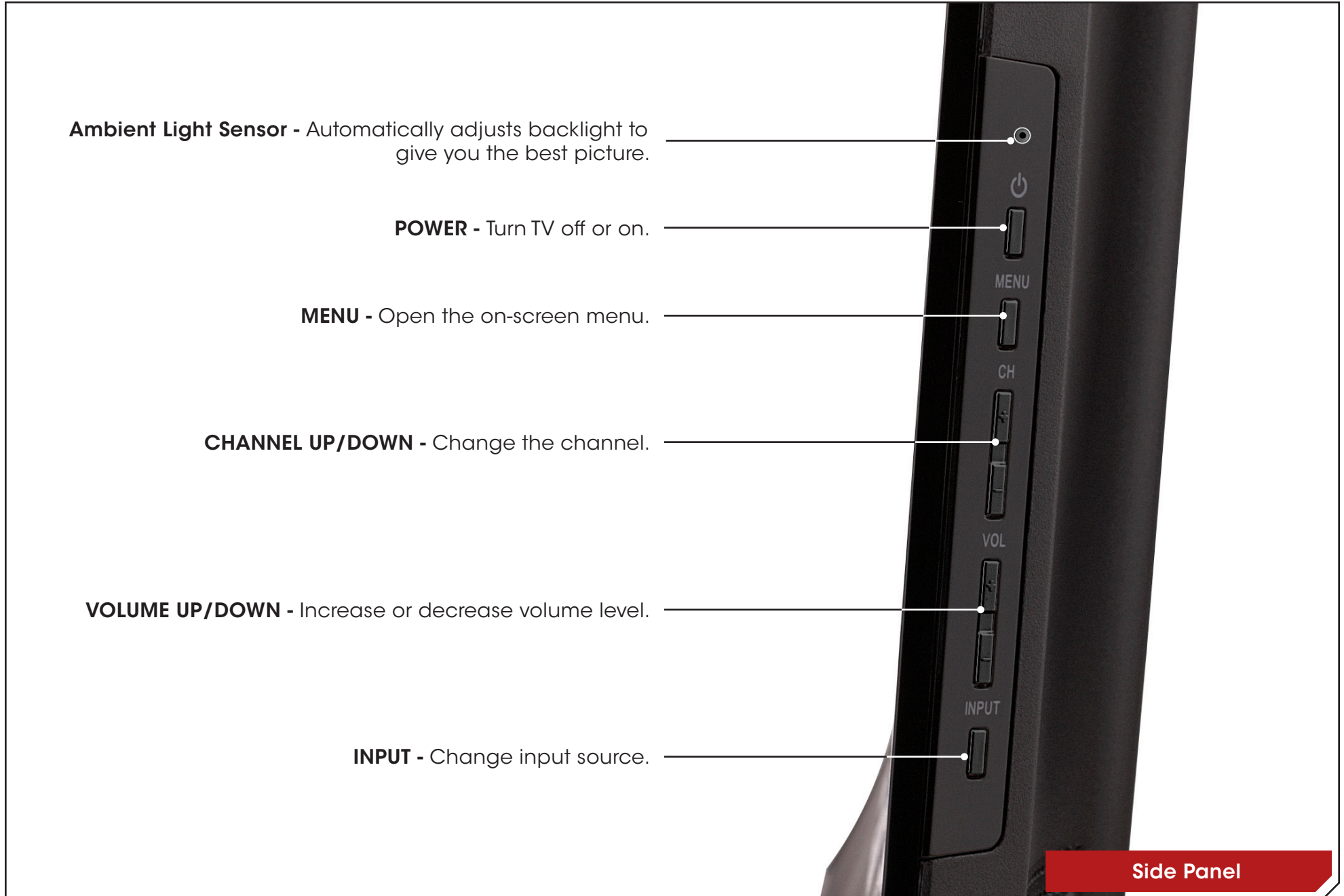

Side Panel

## FRONT PANEL



**REMOTE SENSOR**

When using the remote, aim it directly at this sensor.

Front Panel

## REMOTE CONTROL



Remote Control



### Replacing the Batteries

1. Remove the battery cover.
2. Insert two batteries into the remote control. Make sure that the (+) and (-) symbols on the batteries match the (+) and (-) symbols inside the battery compartment.
3. Replace the battery cover.



- Use only good quality batteries.
- Inserting the batteries incorrectly may result in cracking or leakage that may cause a fire or result in injury.
- Dispose of old or dead batteries in accordance with local hazardous waste regulations.
- Keep batteries away from children and pets.



## CONNECTING A DEVICE (E191VA & E221VA)

Your TV can be used to display output from most devices.

1. Verify that your device has a video port that matches an available port on the TV (HDMI, Component, etc).
2. Turn the TV and your device off.
3. Connect the appropriate cable (not included) to the TV and the device.
4. Turn the TV and your device on. Set the TV's input to match the connection you used (HDMI, Component, etc).



Cable/Satellite Box



DVD/Blu-ray Player



Game Console

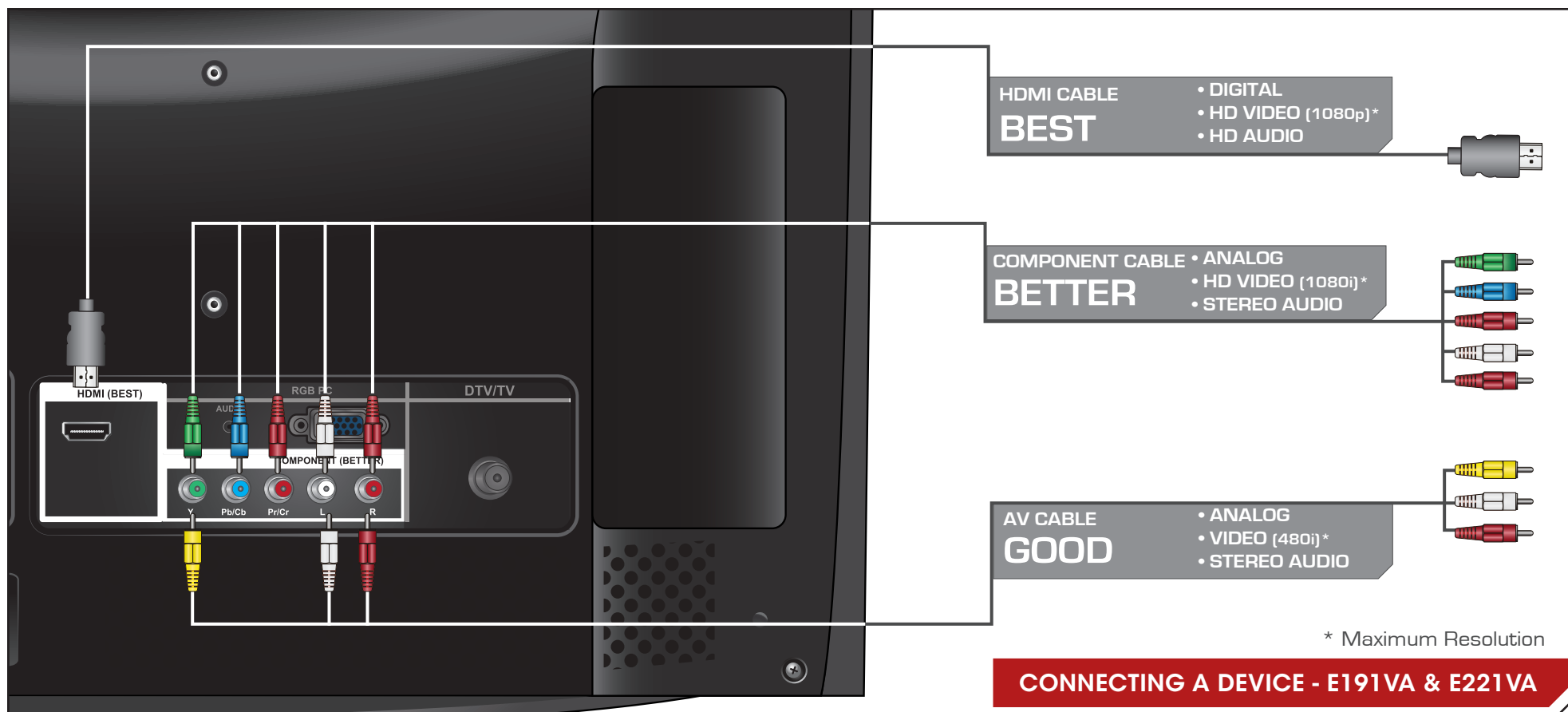

## CONNECTING A DEVICE (E261VA)

Your TV can be used to display output from most devices.

1. Verify that your device has a video port that matches an available port on the TV (HDMI, Component, etc).
2. Turn the TV and your device off.
3. Connect the appropriate cable (not included) to the TV and the device.
4. Turn the TV and your device on. Set the TV's input to match the connection you used (HDMI, Component, etc).



Cable/Satellite Box



DVD/Blu-ray Player



Game Console

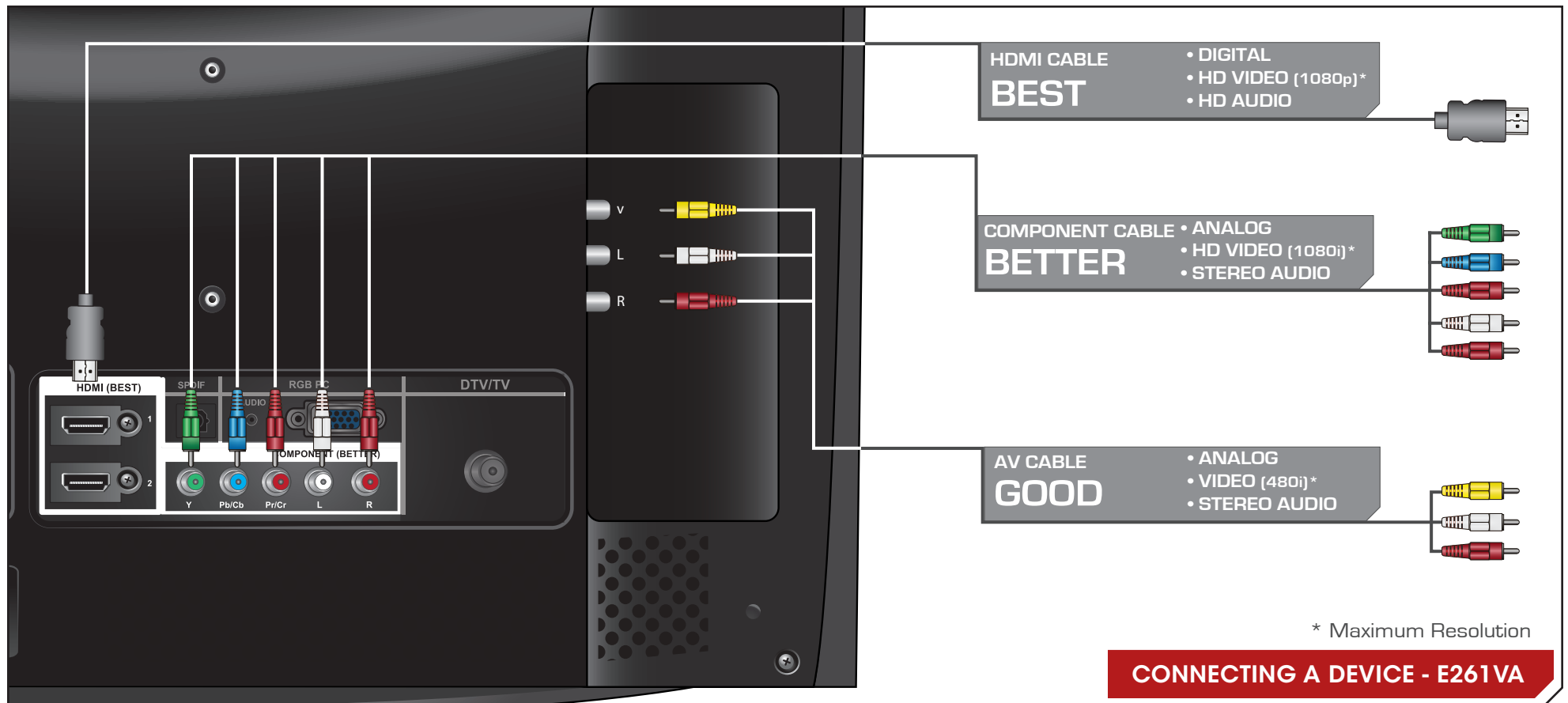

CONNECTING A DEVICE - E261VA

## CONNECTING A PC

Your TV can be used to display output from a personal computer.

To use your TV as a PC display:

1. Connect an RGB cable (not included) to your PC and the RGB port on the back of the TV. This cable transmits video.
2. Connect a 3.5mm cable (not included) to your PC and the PC Audio In port on the back of the TV. This cable transmits audio.
3. Set your PC's resolution to match the resolution of your TV. See *Appendix B - Specifications*.



Personal Computer

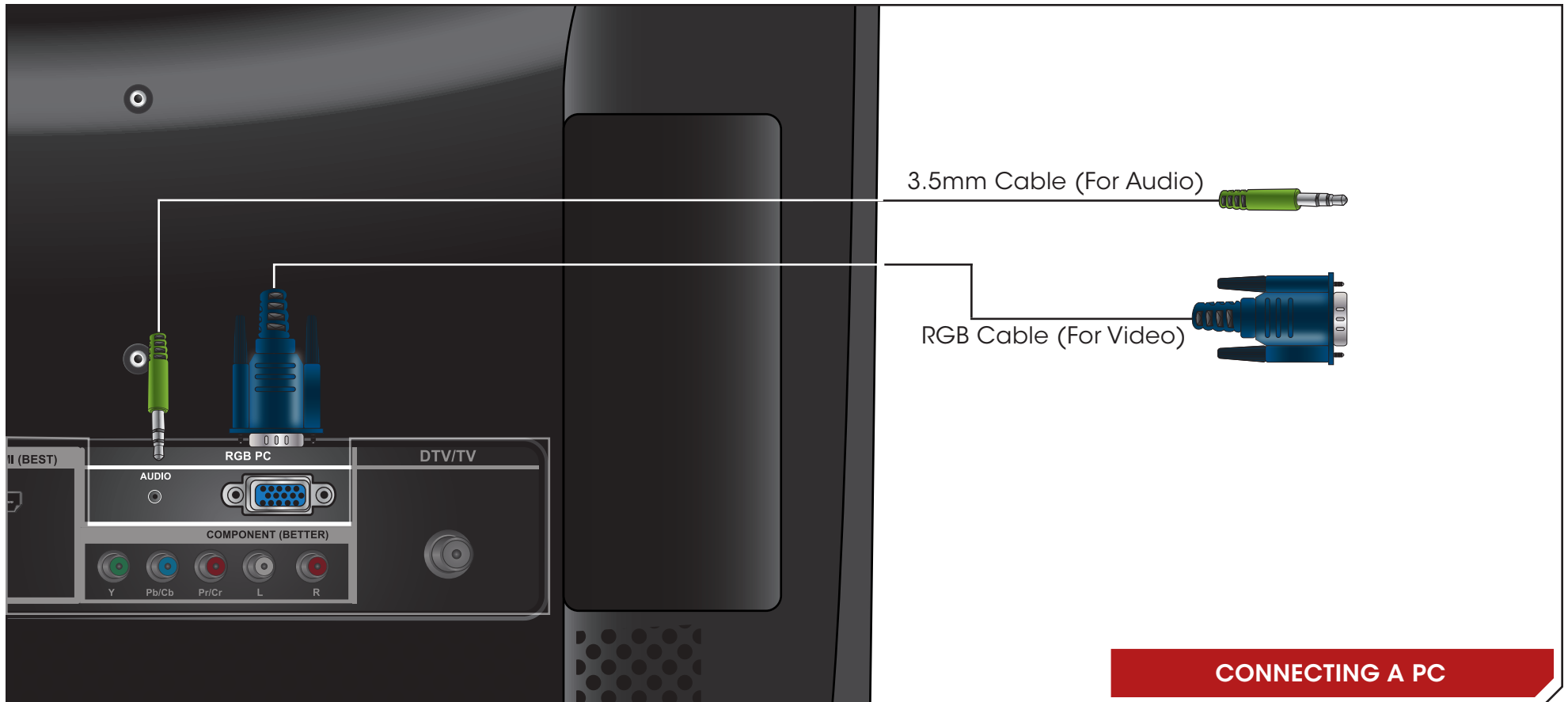

The first time you turn on the TV, the Setup App will guide you through each of the steps necessary to get your TV ready for use.

Before you begin the first-time setup:

- Your TV should be installed and the power cord should be connected to an electrical outlet. See *Installing the TV* on page 3.
- Have your remote ready. Ensure the batteries are inserted.
- Your devices should be connected. See *Connecting Your Devices* on page 7.

To complete the first-time setup:

1. Turn the TV on by pressing the **Power** button on the remote.

The Setup App is displayed.

Press the **Right Arrow** button on the remote to go to the next screen.

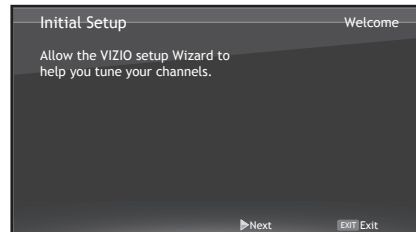

2. Use the **Up/Down Arrow** buttons on the remote to highlight your preferred language, then press **Right Arrow**

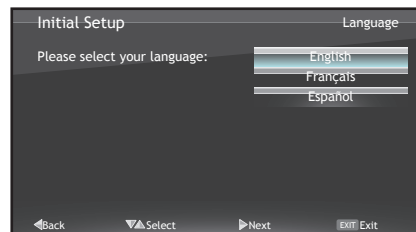

3. Use the **Up/Down Arrow** buttons on the remote to highlight **Home** and press **Right Arrow**.

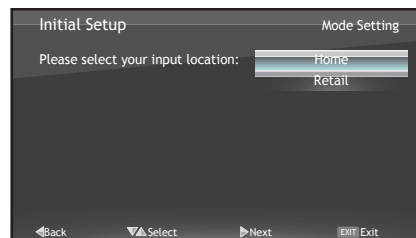

4. Use the **Up/Down Arrow** buttons on the remote to highlight your preferred Time Zone, then press the **Right Arrow**.

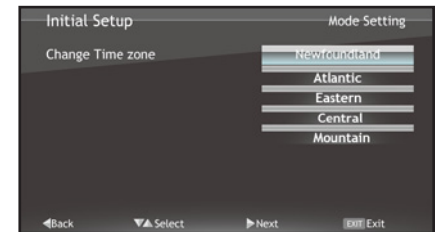

5. If the TV is connected to an external antenna, select **Antenna**, then press **Right Arrow** and go to step 5.

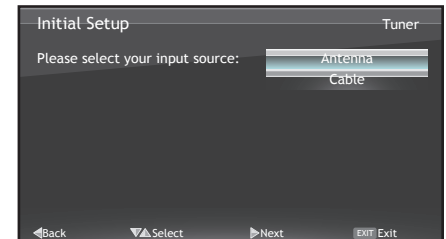

If the TV is connected to a cable service without a set-top box (cable is connected directly from the wall outlet) select **Cable**, then press **Right Arrow** and go to step 5.

If the TV is connected to a cable or satellite set-top box, press the **EXIT** button on the remote, then select the input to which your set-top box is connected (HDMI, COMP, or AV).

6. Use the **Up/Down Arrow** buttons on the remote to highlight **Scan**, then press **Right Arrow**.

The TV begins a channel scan.

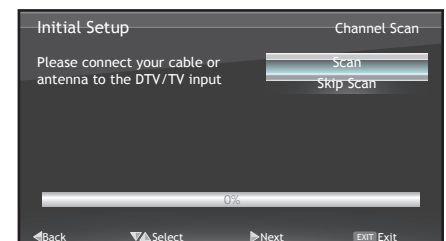

7. Wait for the channel scan to finish.

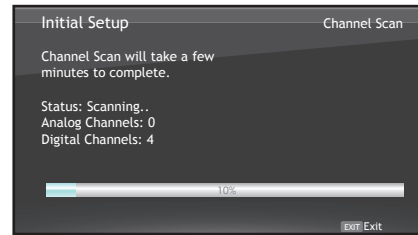

8. When the channel scan is complete, the Congratulations screen is displayed.

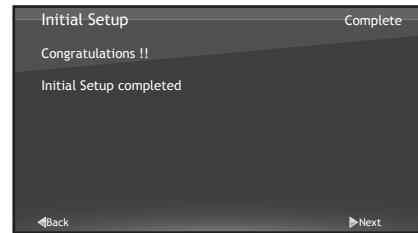

**The First-Time Setup is complete.**

Your TV features an easy-to-use on-screen menu.

To open the on-screen menu, press the **MENU** button on the remote. You can also open the on-screen menu by pressing the **VIA** button and selecting **HDTV Settings** from the VIA Dock, then pressing **OK**.

From this menu, you can:

- Change the input source
- Change the screen aspect ratio
- Set up closed captioning
- Activate the sleep timer
- Adjust the picture settings
- Adjust the audio settings
- Change TV settings

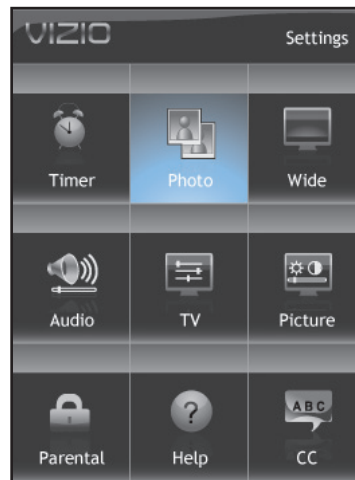

## NAVIGATING THE ON-SCREEN MENU

To open the on-screen menu, press the **MENU/OK** button on the remote.

Use the **Arrow** buttons to highlight a menu option, and press the **MENU/OK** button to select that option.



While navigating the on-screen menu, you can press the **BACK** button at any time to return to the previous menu screen. The **EXIT** button will close the on-screen menu.

## CHANGING THE INPUT SOURCE

External devices such as DVD players, Blu-Ray Players, and video game consoles can be connected to your TV. To use one of these devices with your TV, you must first change the input source in the on-screen menu.

To change the input device:

1. Press the **MENU** button on the remote. The on-screen menu is displayed.
2. Use the **Arrow** buttons on the remote to highlight the **TV** icon and press **OK**.
3. Use the **Up/Down Arrow** buttons on the remote to highlight the input source and press **OK**. The Input Source Selection menu is displayed.
4. Use the **Up/Down Arrow** buttons on the remote to highlight the input source you wish to display. Press **OK**, then press **EXIT**.

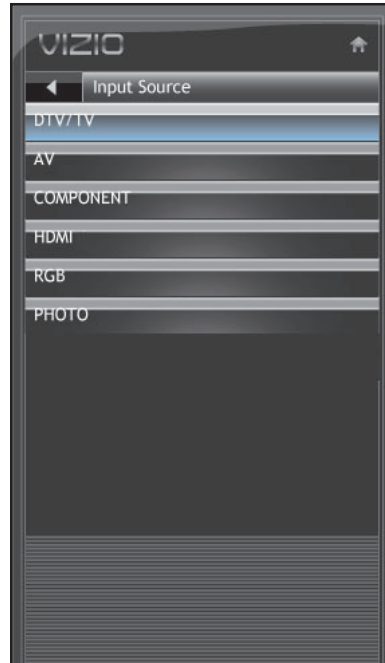

You can also change the input device by pressing the **INPUT** button on the remote.

## CHANGING THE SCREEN ASPECT RATIO

The TV can display images in four different modes: Wide, Zoom, Normal, and Stretch. Each mode displays the picture differently.

To change the screen aspect ratio:

1. Press the **MENU** button on the remote.
2. Use the **Arrow** buttons to highlight the **Wide** icon. Press **OK**.
3. Use the **Arrow** buttons to highlight your desired screen mode and press **OK**:
  - **Normal** preserves the content's original aspect ratio. Since the 4:3 aspect ratio is not large enough to fill the TV's screen, black bars are added to the left and right of the display image.
  - **Wide** stretches a 4:3 aspect ratio picture to the edges of the screen. Since the picture is being stretched, the display image may appear distorted. If the program is already formatted for widescreen viewing (1.85:1 or 2.35:1), then black bars will appear on the top and bottom of the display image.
  - **Zoom** expands images with black bars to fit the screen.
  - **Panoramic** expands the display image to fill the screen. Images may appear wider than intended. If you are watching widescreen (1.85:1 or 2.35:1) content, black bars will still appear on the top and bottom of the display image. **This option is only available when the TV is displaying a 480i/480p source.**
  - **Stretch** expands the display image to fill the screen. Images may appear wider than intended. If you are watching widescreen (1.85:1 or 2.35:1) content, black bars will still appear on the top and bottom of the display image. **This option is only available when the TV is displaying a 720p/1080i/1080p source.**

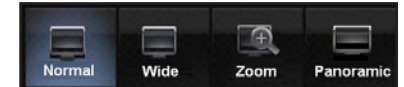



## SETTING UP CLOSED CAPTIONING

Your TV can display closed captions for programs that include them. Closed captions display a transcription of a program's dialogue.



If the program you are viewing is not being broadcast with closed captions, the TV will not display them.

To activate or deactivate closed captions:

1. Press the **MENU** button on the remote. The on-screen menu is displayed.
2. Use the **Arrow** buttons on the remote to highlight the **CC** icon and press **OK**. The Closed Caption menu is displayed.
3. Use the **Arrow** buttons on the remote to highlight the type of closed captions you wish to see:
  - **Analog Closed Caption** for analog (NTSC) TV channels.
  - **Digital Closed Caption** for digital (ATSC) TV channels.
4. After highlighting the type of closed captions you wish to see, use the **Left/Right Arrow** buttons on the remote to select the caption channel you wish to display, then press **EXIT**.



Caption channels usually display different languages. For example, CC1 may display English captions and CC2 may display Spanish captions.

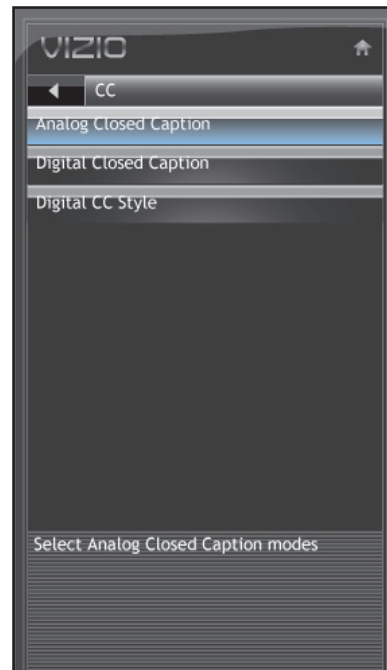

## Changing the Appearance of Digital Closed Captions

Digital closed captions can be displayed according to your preference.

To change the appearance of digital closed captions:

1. From the Closed Caption menu, use the **Arrow** buttons to highlight **Digital CC Style**.
2. Use the **Left/Right Arrow** buttons on the remote to select **Custom**, then press **OK**. The Digital CC Style menu appears.
3. Use the **Up/Down Arrow** buttons on the remote to highlight the setting you wish to change, then use the **Left/Right Arrow** buttons to change the setting:
  - **Caption Style** - Choose Auto to keep default settings or Custom to manually change each setting.
  - **Text Size** - Adjust the size of the text.
  - **Color** - Change the color of the text.
  - **Opacity** - Change the transparency of the text.
  - **BG Color** - Change the background color.
  - **BG Opacity** - Change the transparency of the background.
  - **Window Color** - Change the edge color.
  - **Window Opacity** - Change the edge type.
4. When you are satisfied with the appearance of the closed captions, press the **EXIT** button on the remote.

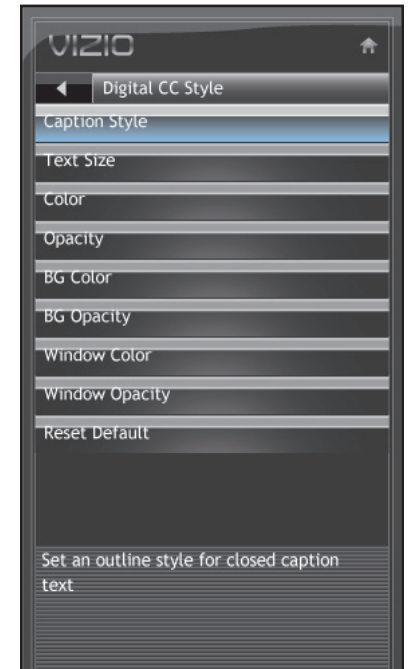

## ACTIVATING THE SLEEP TIMER

When activated, the TV's sleep timer will turn the TV off after a set period of time.

To use the sleep timer:

1. Press the **MENU** button on the remote. The on-screen menu is displayed.
2. Use the **Arrow** buttons on the remote to highlight the **Sleep Timer** icon and press **OK**. The Sleep Timer menu is displayed.
3. Use the **Up/Down Arrow** buttons on the remote to highlight **Timer** and press **OK**. The Timers menu is displayed.
4. Use the **Up/Down Arrow** buttons on the remote to highlight the period of time after which you want the TV to turn off: **30, 60, 90, 120, or 180 minutes**.
5. Press **OK**, then press **EXIT**.

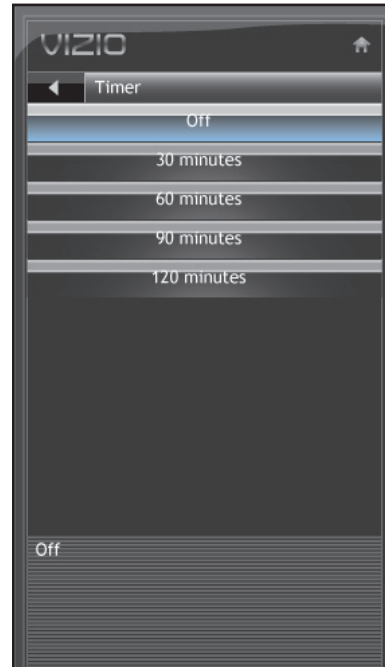

## Setting the Auto Power Off Feature

To help save energy, your TV is set by default to turn off after 10 minutes if no signal is being displayed on the screen. This feature can be deactivated.

To set the Auto Power Off feature:

1. From the Sleep Timer menu, use the **Up/Down Arrow** buttons on the remote to highlight **Auto Power Off** and press **OK**. The Auto Power-Off menu is displayed.
2. Highlight **Off** or **10 min** and press **OK**. Press **Exit**.

## ADJUSTING THE PICTURE SETTINGS

Using the Picture menu, you can adjust the following settings:

- Change the picture mode
- Adjust noise reduction
- Enable or disable Fast Response
- Enable or disable the ambient light sensor
- Reset the picture mode settings

To adjust the picture mode:

1. Press the **MENU/OK** button on the remote. The on-screen menu is displayed.
2. Use the **Arrow** buttons to highlight **Picture** and press **MENU/OK**.
3. Use the **Arrow** buttons to highlight **Picture Mode** and press **MENU/OK**.
4. Use the Arrow buttons to highlight one of the following options, then press **MENU/OK**:
  - **Home** - Sets the various picture settings to values that will produce the best picture in the most cases. This is the recommended setting.
  - **Game** - Optimizes the picture settings for displaying game console output.
  - **Movie** - Sets the picture settings to values perfect for watching a movie in a dark room.



- **Retail** - Sets the picture settings to values that produce a brighter, more vivid picture.
- **Photo** - Optimizes the picture settings for viewing photo slideshows. Flesh tones should appear more natural.
- **Custom** - Allows you to manually change each of the picture settings:

**Brightness** - Adjusts the black level of the picture. When this setting is too low, the picture may be too dark to distinguish details. When this setting is too high, the picture may appear faded or washed out.

**Contrast** - Adjusts the white level of the picture. When this setting is too high, the picture may appear dark. When this setting is too low, the picture may appear faded or washed out. If the setting is too high or too low, detail may be difficult to distinguish in dark or bright areas of the picture.

**Color** - Adjusts the intensity of the picture colors.

**Tint** - Adjusts the hue of the picture. This setting is useful in adjusting the flesh tones in the picture. If flesh appears too orange, reduce the level of color before adjusting tint.

**Sharpness** - Adjusts the edge sharpness of picture elements. It can be used to sharpen non-HD (high definition) content; however, it will not produce detail that does not otherwise exist.

**Backlight** - Adjusts the LED brightness to affect the overall brilliance of the picture. This option is not available unless Ambient Light Sensor is set to OFF.

**Adaptive Luma** - Adjusts the average brightness of the picture to compensate for large areas of brightness.

**Color Enhancement** - Reduces oversaturation of some colors and improves flesh tones.

**Color Temperature** - Changes the "warmness" or "coolness" of the white areas of the picture.

**Reset Picture Setting** - Restores custom picture settings to the factory defaults.

### Adjusting the Noise Reduction Setting

Noise reduction diminishes artifacts such as "blockiness" or "pixellation". When activated, the resulting picture usually has softer edges.

To adjust the noise reduction setting:

1. Press the **MENU/OK** button on the remote. The on-screen menu is displayed.
2. Use the **Arrow** buttons to highlight **Picture** and press **MENU/OK**.
3. Use the **Arrow** buttons to highlight **Noise Reduction** and press **MENU/OK**.
4. Use the **Arrow** buttons to highlight **Off**, **Low**, **Medium**, or **High**, then press **MENU/OK**.
5. Press **EXIT**.



## Enabling or Disabling Fast Response

Enabling the Fast Response setting can often improve PC and console gaming experiences.

To enable or disable Fast Response:

1. Press the **MENU/OK** button on the remote. The on-screen menu is displayed.
2. Use the **Arrow** buttons to highlight **Picture** and press **MENU/OK**.
3. Use the **Arrow** buttons to highlight **Fast Response**.
4. Use the **Left/Right Arrow** buttons to change the setting to **Off** or **On**.
5. Press **EXIT**.

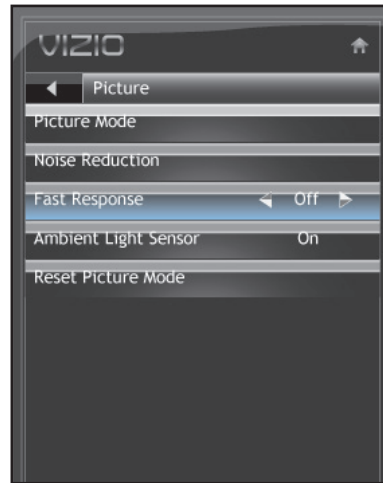

## Enabling or Disabling the Ambient Light Sensor

When enabled, the ambient light sensor detects the light levels in the room to optimize the brightness of the TV's backlight.



When the ambient light sensor is enabled, you will be unable to manually change the TV's brightness settings.

To enable or disable the ambient light sensor:

1. Press the **MENU/OK** button on the remote. The on-screen menu is displayed.
2. Use the **Arrow** buttons to highlight **Picture** and press **MENU/OK**.
3. Use the **Arrow** buttons to highlight **Ambient Light Sensor**.
4. Use the **Left/Right Arrow** buttons to change the setting to **Off** or **On**.
5. Press **EXIT**.

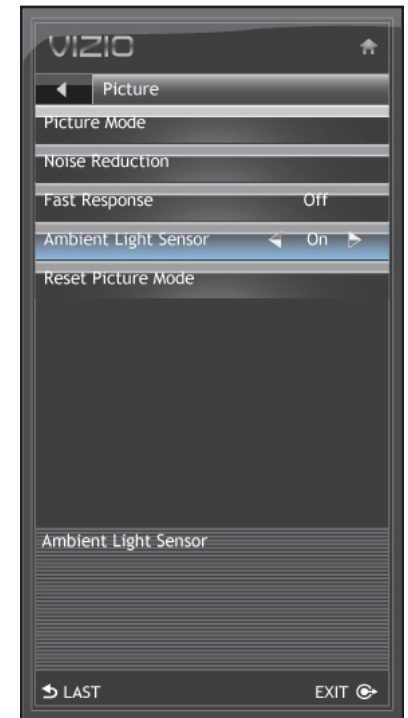

## Resetting the Picture Settings

To restore the TV's picture settings to the factory defaults:

1. Press the **MENU/OK** button on the remote. The on-screen menu is displayed.
2. Use the **Arrow** buttons to highlight **Picture** and press **MENU/OK**.
3. Use the **Arrow** buttons to highlight **Reset Picture Mode**, then press **MENU/OK**.
4. Use the **Arrow** buttons to highlight **OK** and press **MENU/OK**.
5. Press **EXIT**.

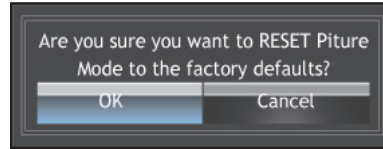

## ADJUSTING THE AUDIO SETTINGS

Using the Audio Settings menu, you can adjust the following:

- Enable or disable SRS TruSurroundHD™
- Enable or disable SRS TruVolume™
- Adjust the equalizer settings
- Adjust bass and treble levels
- Adjust speaker balance
- Enable or disable the built-in speakers
- Select the digital audio output mode
- Change the audio language
- Reset the audio settings

### Enabling or Disabling SRS TruSurroundHD

TruSurround HD is a robust multichannel virtualization technology developed by SRS Labs that provides an enhanced listening experience unlike any other technology offered for a two speaker playback environment.

To enable or disable SRS TruSurroundHD:

1. Press the **MENU/OK** button on the remote. The on-screen menu is displayed.
2. Use the **Arrow** buttons to highlight **Audio** and press **MENU/OK**.
3. Use the **Arrow** buttons to highlight **SRS TruSurround HD**.
4. Press the **Right/Left Arrow** buttons to select **On** or **Off** and press **EXIT**.



## Enabling or Disabling SRS TruVolume

SRS TruVolume intelligently normalizes volume fluctuations due to television commercials or channel changes.

To enable or disable SRS TruVolume:

1. Press the **MENU/OK** button on the remote. The on-screen menu is displayed.
2. Use the **Arrow** buttons to highlight **Audio** and press **MENU/OK**.
3. Use the **Arrow** buttons to highlight **SRS TruVolume**.
4. Press the **Right/Left Arrow** buttons to select **On** or **Off** and press **EXIT**.

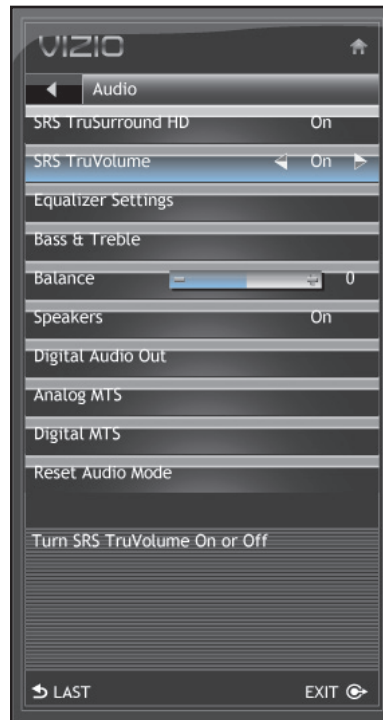

## Adjusting the Equalizer Settings

Your TV features six preset equalizer settings. These settings allow you to customize your TV's sound to match the type of programming you most often enjoy.



The Equalizer Settings menu is not available when SRS TruSurroundHD is enabled.

To adjust the equalizer settings:

1. Press the **MENU/OK** button on the remote. The on-screen menu is displayed.
2. Use the **Arrow** buttons to highlight **Audio** and press **MENU/OK**.
3. Use the **Arrow** buttons to highlight **Equalizer Settings** and press **Menu/OK**.
4. Use the **Arrow** buttons to highlight one of the following settings and press **Menu/OK**:
  - Classical
  - Disco
  - Flat
  - Jazz
  - Pop
  - Rock
5. Press **EXIT**.

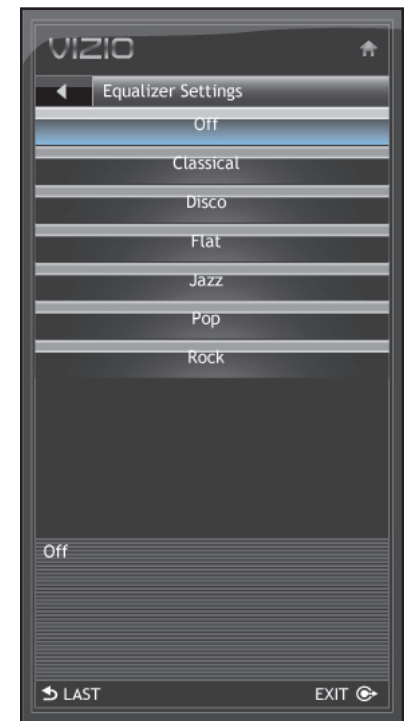

## Adjusting Bass and Treble Levels

The bass and treble levels for your TV's built-in speakers can be adjusted to your liking.



To adjust the bass and treble levels, you must disable SRS TruSurroundHD and change the Equalizer Settings to Off.

To adjust the bass and treble levels:

1. Press the **MENU/OK** button on the remote. The on-screen menu is displayed.
2. Use the **Arrow** buttons to highlight **Audio** and press **MENU/OK**.
3. Use the **Arrow** buttons to highlight **Bass & Treble** and press **MENU/OK**.
4. Use the **Arrow** buttons to highlight **Bass** or **Treble** and press **MENU/OK**.
5. Use the **Left/Right Arrow** buttons to increase or decrease the level. When you are finished, press **EXIT**.

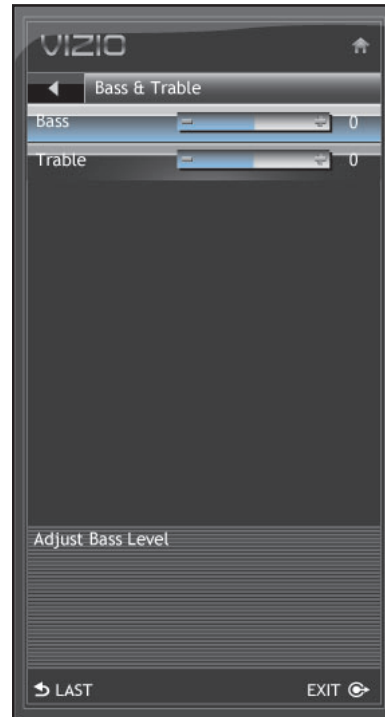

## Adjusting the Speaker Balance

The built-in speakers can be adjusted to distribute the sound between the left and right speakers.

To adjust the speaker balance:

1. Press the **MENU/OK** button on the remote. The on-screen menu is displayed.
2. Use the **Arrow** buttons to highlight **Audio** and press **MENU/OK**.
3. Use the **Arrow** buttons to highlight **Balance** and press **MENU/OK**.
4. Use the **Arrow** buttons to adjust the speaker balance:
  - To increase the loudness of the right speaker, increase the balance setting.
  - To increase the loudness of the left speaker, decrease the balance setting.

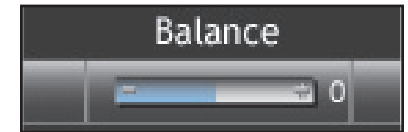



## Enabling or Disabling the Built-In Speakers

Using this menu option, you can turn the built-in speakers on or off. This is often used when the TV is connected to a home audio system.

To enable or disable the built-in speakers:

1. Press the **MENU/OK** button on the remote. The on-screen menu is displayed.
2. Use the **Arrow** buttons to highlight **Audio** and press **MENU/OK**.
3. Use the **Arrow** buttons to highlight **Speakers** and press **MENU/OK**.
4. Press the **Right/Left Arrow** buttons to select **On** or **Off** and press **EXIT**.

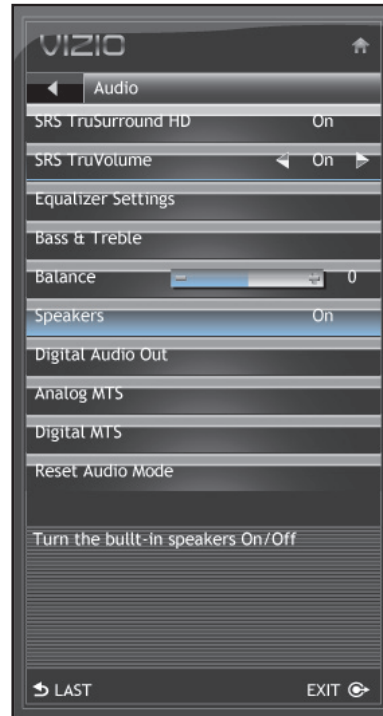

## Changing the Audio Language

Some digital free-to-air and cable channels broadcast programs in more than one language. The TV's MTS (Multichannel Television Sound) feature allows you to listen to audio in your preferred language.



Not all programs are broadcast in multiple languages. The MTS feature only works when the program being viewed is being broadcast in the language you select.

To change the MTS language:

1. Press the **MENU/OK** button on the remote. The on-screen menu is displayed.
2. Use the **Arrow** buttons to highlight **Audio** and press **MENU/OK**.
3. Use the **Arrow** buttons to highlight **Analog MTS** or **Digital MTS** and press **MENU/OK**.

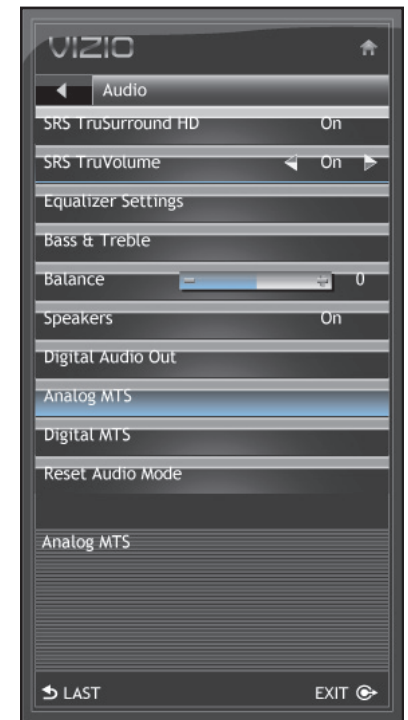

## Resetting the Audio Settings

To reset the audio settings to the factory default settings:

1. Press the **MENU/OK** button on the remote. The on-screen menu is displayed.
2. Use the **Arrow** buttons to highlight **Audio** and press **MENU/OK**.
3. Use the **Arrow** buttons to highlight **Reset Audio Mode** and press **MENU/OK**.
4. The TV displays "Are you sure you want to RESET Audio Settings to the factory defaults?"

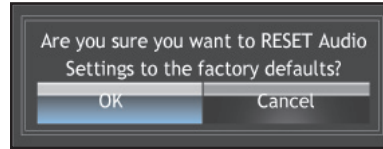

Use the Arrow buttons to highlight **OK** and press **MENU/OK**.

5. Press **EXIT**.

## CHANGING THE TV SETTINGS

From the TV Settings Menu, you can:

- Set up channels
- Change the on-screen menu language
- Change the TV's date and time
- Adjust the TV settings for use with a PC

## CUSTOMIZING AND REMOVING INPUT NAMES

When you have multiple devices connected to your TV, it can become difficult to remember the inputs to which they are connected. Your TV features the ability to customize the names of these inputs to make them easy to remember. (Custom names have a 10-character limit.)

For example, *HDMI 1* could be renamed as *My Blu-ray*.

You can also remove unused inputs from the input list, making selection of the correct input faster.

### Customizing Input Names

To customize an input name:

1. Press the **MENU** button on the remote. The on-screen menu is displayed.
2. Use the **Arrow** buttons on the remote to highlight the **TV** icon and press **MENU/OK**.
3. Use the **Arrow** buttons to highlight **Input** and press **MENU/OK**.
4. Use the **Arrow** buttons to highlight **Input Naming** and press **MENU/OK**.



- Use the **Arrow** buttons on the remote to highlight the input source you wish to rename, then press **MENU/OK**.
- Use the **Arrow** buttons to highlight **Input Naming** and press **MENU/OK**.

The on-screen keyboard is displayed.

- Use the **Arrow** and **MENU/OK** buttons to spell the custom input name.

When you are finished, highlight **OK** and press **MENU/OK**.

- Press **EXIT**.

### Removing Unused Inputs from the Input List

To remove unused inputs:

- Press the **MENU** button on the remote. The on-screen menu is displayed.
- Use the **Arrow** buttons on the remote to highlight the **Input** icon and press **MENU/OK**.
- Use the **Arrow** buttons to highlight **Input Naming** and press **MENU/OK**.
- Use the **Arrow** buttons on the remote to highlight the input source you wish to remove, then press **MENU/OK**.
- Use the **Arrow** buttons to highlight **Skip Input** and press **MENU/OK**.
- Press **EXIT**.



To restore an input to the list, go to the Input Naming screen and select Reset.

## SETTING UP CHANNELS

From the channel menu you can:

- Change the signal source
- Customize the master channel list
- Scan for new/additional channels
- Start a new channel scan
- Customize channel names

### Changing the Signal Source

Using this option, you can change the signal source for the coaxial (TV) input.

To change the signal source:

- Press the **MENU** button on the remote. The on-screen menu is displayed.
- Use the **Arrow** buttons on the remote to highlight the **TV** icon and press **MENU/OK**. The TV Settings menu is displayed.
- Use the **Arrow** buttons to highlight **Channels** and press **MENU/OK**.
- Use the **Arrow** buttons to highlight **Signal Source**.
- Use the **Arrow** buttons to change the setting to **Cable** or **Antenna**.
- Press **EXIT**.



## Customizing the Master Channel List

By customizing the master channel list, you can choose which channels can be displayed.

1. Press the **MENU** button on the remote. The on-screen menu is displayed.
2. Use the **Arrow** buttons on the remote to highlight the **TV** icon and press **MENU/OK**. The TV Settings menu is displayed.
3. Use the **Arrow** buttons to highlight **Channels** and press **MENU/OK**.
4. Use the **Arrow** buttons to highlight **Master Lists**, then press **MENU/OK**.

The master channel list is displayed.

5. To add a channel to the list, highlight the channel and press **MENU/OK**. When a channel is available, a check mark is displayed next to the channel.

To remove a channel from the list, highlight the channel and press **MENU/OK**. When the channel has been removed, the checkmark next to the channel will disappear.

To add all available channels to the list, highlight **Mark All** and press **MENU/OK**.

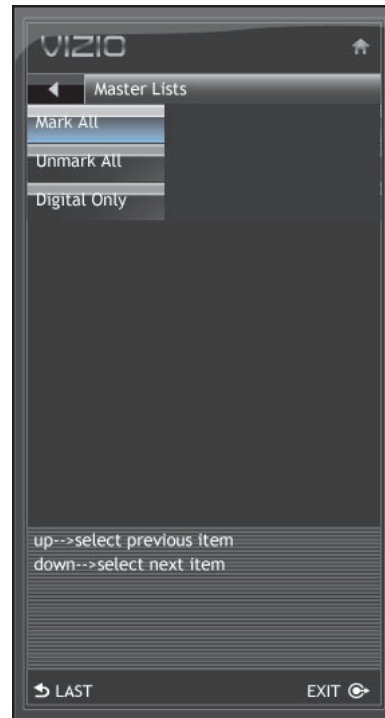

To remove all available channels from the list, highlight **Unmark All** and press **MENU/OK**.

To include only digital channels in the list, highlight **Digital Only** and press **MENU/OK**.

6. Press **EXIT**.

## Scanning for New or Additional Channels

When a new channel becomes available in your area, you do not have to rescan all channels to add the new channel. Using the add channel feature, you can restrict the scan to new channels only.

This is useful because your master channel list settings are preserved.

To scan for new channels:

1. Press the **MENU** button on the remote. The on-screen menu is displayed.
2. Use the **Arrow** buttons on the remote to highlight the **TV** icon and press **MENU/OK**. The TV Settings menu is displayed.
3. Use the **Arrow** buttons to highlight **Channels** and press **MENU/OK**.
4. Use the **Arrow** buttons to highlight **Additional Scan**.
5. Use the **Left/Right Arrow** buttons to change the option to **On** or **Off**.

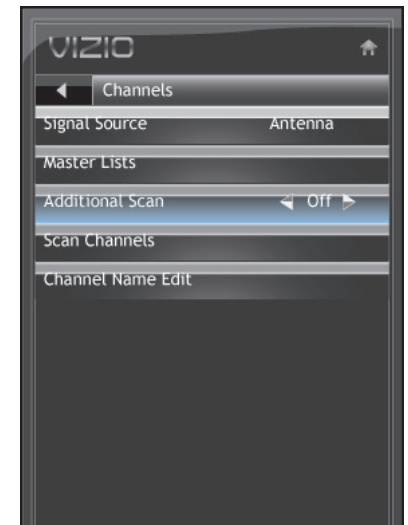

6. Perform a channel scan. See *Scanning for Channels* on page 30.

### Scanning for Channels

Before the TV can detect and display channels and their associated information, you must scan for channels. A channel scan may also be necessary when the TV has been moved to an area where different free-to-air broadcast television channels are available.

To scan for channels:

1. Press the **MENU** button on the remote. The on-screen menu is displayed.
2. Use the **Arrow** buttons on the remote to highlight the **TV** icon and press **MENU/OK**. The TV Settings menu is displayed.
3. Use the **Arrow** buttons to highlight **Channels** and press **MENU/OK**.
4. Use the **Arrow** buttons to highlight **Channel Scan** and press **MENU/OK**.
5. Use the **Arrow** buttons to highlight **On** and press **MENU/OK**.

The channel scan begins.

6. Wait for the channel scan to reach 100%, then press **EXIT**.

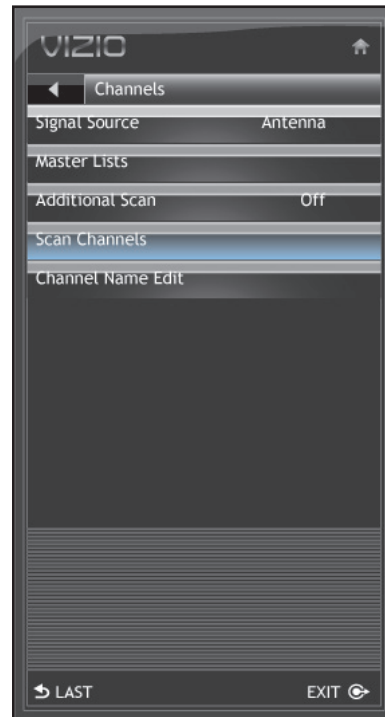

### Customizing Channel Names

Your TV features the ability to customize channel names, making them easy to identify. (Custom names have a 10-character limit.)

For example, *KBOT-DT* could be renamed as *Favorite*.

To customize a channel name:

1. Press the **MENU** button on the remote. The on-screen menu is displayed.
2. Use the **Arrow** buttons on the remote to highlight the **TV** icon and press **MENU/OK**. The TV Settings menu is displayed.
3. Use the **Arrow** buttons to highlight **Channels** and press **MENU/OK**.
4. Use the **Arrow** buttons to highlight **Channel Name Edit** and press **MENU/OK**.
5. Highlight the name of the channel you want to customize and press **MENU/OK**.

The on-screen keyboard is displayed.

6. Use the **Arrow** and **MENU/OK** buttons to spell the custom channel name.

When you are finished, highlight **OK** and press **MENU/OK**.

7. Press **EXIT**.

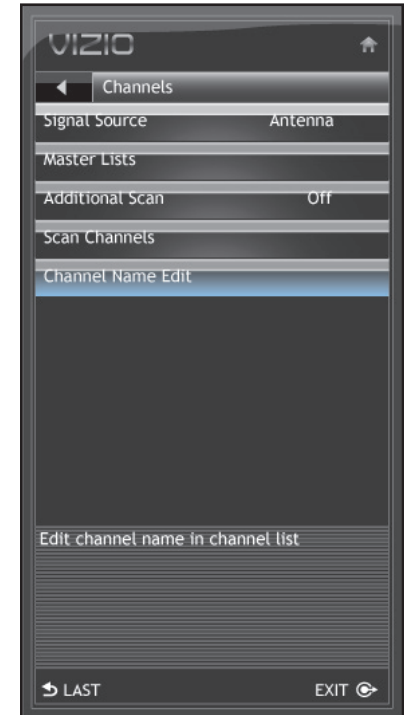

## CHANGING THE ON-SCREEN MENU LANGUAGE

Your TV can display the on-screen menu in different languages.

To change the on-screen menu language:

1. Press the **MENU** button on the remote. The on-screen menu is displayed.
2. Use the **Arrow** buttons on the remote to highlight the **TV** icon and press **MENU/OK**. The TV Settings menu is displayed.
3. Use the **Arrow** buttons to highlight **Menu Language** and press **MENU/OK**.
4. Use the **Arrow** buttons to highlight your preferred language and press **MENU/OK**.
5. Press **EXIT**.



## SETTING THE TV'S DATE AND TIME

From the Date & Time menu, you can:

- Set the time zone
- Adjust the time for daylight savings
- Enable or disable automatic date and time updates
- Set the current date and time

### Setting the Time Zone

To set the time zone:

1. Press the **MENU** button on the remote. The on-screen menu is displayed.
2. Use the **Arrow** buttons on the remote to highlight the **TV** icon and press **MENU/OK**. The TV Settings menu is displayed.
3. Use the **Arrow** buttons to highlight **Date & Time** and press **MENU/OK**.
4. Use the **Arrow** buttons to highlight **Time Zone** and press **MENU/OK**.
5. Use the **Arrow** buttons to highlight your time zone and press **MENU/OK**.
6. Press **EXIT**.

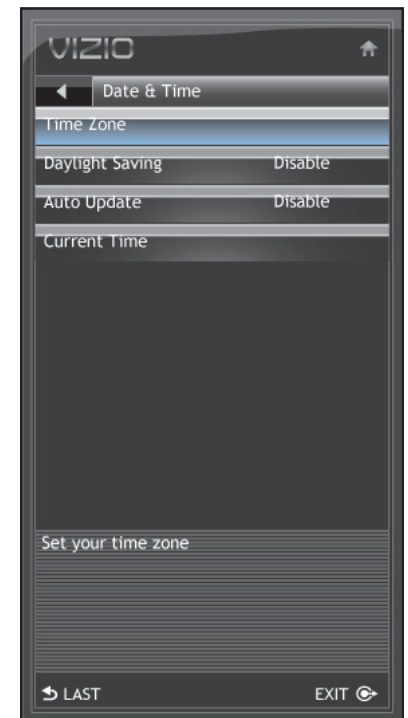

## Adjusting the Time for Daylight Savings

This setting will automatically adjust the time for zones which recognize daylight savings time.

To enable or disable the daylight savings adjustment:

1. Press the **MENU** button on the remote. The on-screen menu is displayed.
2. Use the **Arrow** buttons on the remote to highlight the **TV** icon and press **MENU/OK**. The TV Settings menu is displayed.
3. Use the **Arrow** buttons to highlight **Date & Time** and press **MENU/OK**.
4. Use the **Arrow** buttons to highlight **Daylight Saving**.
5. Use the **Arrow** buttons to change the setting to **Enable** or **Disable**.
6. Press **EXIT**.

## Enabling or Disabling Automatic Date and Time Updates

The current date and time is broadcast digitally in many areas. Your TV can automatically set the time and date using this information.



When this setting is enabled, you cannot manually set the date and time.

To enable or disable automatic updates:

1. Press the **MENU** button on the remote. The on-screen menu is displayed.
2. Use the **Arrow** buttons on the remote to highlight the **TV** icon and press **MENU/OK**. The TV Settings menu is displayed.
3. Use the **Arrow** buttons to highlight **Date & Time** and press **MENU/OK**.
4. Use the **Arrow** buttons to highlight **Auto Update**.

5. Use the **Arrow** buttons to change the setting to **Enable** or **Disable**.
6. Press **EXIT**.

## Setting the Date and Time

Using this menu option, you can manually set the TV's date and time.

To manually set the date and time:

1. Press the **MENU** button on the remote. The on-screen menu is displayed.
2. Use the **Arrow** buttons on the remote to highlight the **TV** icon and press **MENU/OK**. The TV Settings menu is displayed.
3. Use the **Arrow** buttons to highlight **Date & Time** and press **MENU/OK**.
4. Use the **Arrow** buttons to highlight **Current Time**.
5. Use the **Arrow** buttons to highlight individual numbers in the date and time. Use the **Number Pad** to enter the current date and time.
6. Press **EXIT**.



## ADJUSTING THE TV SETTINGS FOR USE WITH A PC

Your TV can be used to display output from a home computer using the RGB port.



These settings are only available when viewing content from the RGB port.

To adjust the PC settings:

1. Press the **MENU** button on the remote. The on-screen menu is displayed.
2. Use the **Arrow** buttons on the remote to highlight the **TV** icon and press **MENU/OK**. The TV Settings menu is displayed.
3. Use the **Arrow** buttons to highlight **PC Setting** and press **MENU/OK**.
4. Use the **Arrow** and **MENU/OK** buttons to adjust each of the following options:

**Horiz. Position** - Adjust the horizontal (left/right) position of the picture.

**Vertical Position** - Adjust the vertical (up/down) position of the picture.

**Fine Tune** - Adjust the synchronization between the PC and the TV. Increase or decrease this setting if you see "waviness" or a blurry picture.

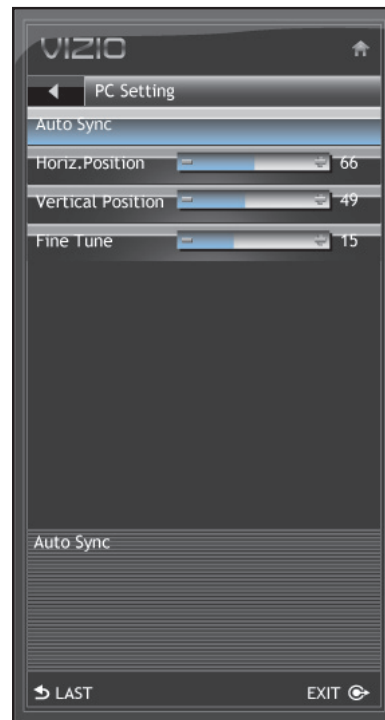

If you would like the TV to automatically adjust the picture for best quality, select **Auto Sync** and press **MENU/OK**.

## SETTING THE PARENTAL CONTROLS

The TV's parental controls allow you to prevent the TV from displaying certain channels or programs without a password.

To access the Parental Control menu:

1. Press the **MENU** button on the remote. The on-screen menu is displayed.
2. Use the **Arrow** buttons on the remote to highlight the **Parental** icon and press **MENU/OK**.
3. Enter your parental passcode. If you have not set a custom passcode, the default is **0000**. The Parental Control menu is displayed.

### Enabling or Disabling Program Ratings

To manage program content according to its rating, you must enable the Program Rating feature.

To enable or disable the Program Rating feature:

1. From the Parental Controls menu, highlight **Rating Enable** and press **OK**. The Rating Enable menu is displayed.
2. Select **On** or **Off** and press **OK**.

### Locking and Unlocking Channels

When a channel is locked, it will be inaccessible. Locking a channel is a good way to prevent children from viewing inappropriate material.

To lock or unlock a channel:

1. From the Parental Controls menu, highlight **Channel Locks** and press **OK**. The Channel Locks menu is displayed.



- Highlight the channel you want to lock or unlock and press **OK**.
- When a channel is **locked**, the **Lock** icon appears **locked**. The channel is not accessible unless the parental passcode is entered.
- When a channel is **unlocked**, the **Lock** icon appears **unlocked**. The channel is accessible.

### Blocking and Unblocking Content by Rating

A channel may sometimes broadcast programs that are meant for children, and at other times broadcast programs that are meant for mature audiences. You may not want to block the channel completely using a channel lock, but you may wish to block certain programs from being viewed.

When this is the case, you can use the TV's Rating Block feature to block content based on its rating.



For a list of content ratings and their definitions, visit [www.tvguidelines.org](http://www.tvguidelines.org).

To block or unblock content by its rating:

- From the Parental Controls menu, highlight the content type you want to adjust and press **OK**:

**USA - TV** - USA television program broadcasts.

**USA - Movie** - USA movie broadcasts.

**CAN - English** - Canadian English television program broadcasts.

**CAN - French** - Canadian French television program broadcasts.

- For each rating type you want to block or unblock, use the **Up/Down** and **Left/Right Arrow** buttons on the remote to

highlight the rating type and press **OK**.

- When the rating type is **blocked**, the **Lock** icon appears **locked**. Content with this rating cannot be viewed.
- When the rating type is **unblocked**, the **Lock** icon appears **unlocked**. Content with this rating can be viewed.
- If you want to block all unrated content, highlight **Block Unrated Shows** and use the **Arrow** buttons on the remote to select **On**.
- When you are finished adjusting the rating level blocks, press the **EXIT** button on the remote.

### Changing the Parental Control Passcode

If you use the parental controls, you should change the passcode to prevent children from accessing inappropriate material.

- From the Parental Controls menu, highlight **Change PIN** and press **OK**. The **Change PIN** menu is displayed.
- In the **New Pin** field, use the **Number Pad** on the remote to enter your new 4-digit parental control passcode.
- In the **Confirm Pin** field, use the **Number Pad** on the remote to re-enter your new 4-digit parental control passcode.
- Write down your new parental control passcode and save it in a secure location.
- Press the **EXIT** button on the remote.

### Resetting the Content Locks

To reset the content locks to the factory-default settings:

- From the Parental Controls menu, highlight **RESET LOCKS** and press **OK**. The TV displays, "Are you sure you want to RESET ALL LOCKS SETTINGS to the factory defaults?"
- Highlight **Yes** and press **OK**.

## Adjusting the CEC Settings

The CEC function on your TV enables you to control HDMI-connected devices with the included remote without any additional programming.



Not all HDMI devices support CEC. See your device's user manual for details.

To enable, disable, or adjust CEC settings:

1. Press the **MENU** button on the remote. The on-screen menu is displayed.
2. Use the **Arrow** buttons on the remote to highlight the **Settings** icon and press **OK**. The Settings menu is displayed.
3. Use the **Arrow** buttons on the remote to highlight **CEC Settings** and press **OK**. The CEC Settings menu is displayed.
4. Use the **Arrow** and **OK** buttons to adjust each setting:
  - **CEC Function** - To use CEC, you must select **Enable**.
  - **System Audio Control** - When system audio control is on, you can control your device's audio using the TV's remote control.
  - **Device Discovery** - Use this function to determine if your device is connected and supports CEC.
5. Press the **EXIT** button on the remote.

## VIEWING SYSTEM INFO AND RESETTING TO FACTORY DEFAULTS

You can use the TV's Help menu to:

- Display system information
- Restore the TV to its factory default settings
- Restart the Setup App

### Displaying System Information

To display a summary of the TV settings:

1. Press the **MENU** button on the remote. The on-screen menu is displayed.
2. Use the **Arrow** buttons on the remote to highlight the **Help** icon and press **MENU/OK**. The Help menu is displayed.
3. Highlight **System Info** and press **MENU/OK**. The system information is displayed.
4. When you are finished reviewing the system information, press the **EXIT** button on the remote.



## Restoring the TV to the Factory Default Settings

All of the on-screen menu settings can be reset to the factory defaults.



If you restore the TV to the factory default settings, all changes you have made to the settings will be lost!

To restore the TV to its factory default settings:

1. Press the **MENU** button on the remote. The on-screen menu is displayed.
2. Use the **Arrow** buttons on the remote to highlight the **Help** icon and press **OK**. The Help menu is displayed.
3. Highlight **System Reset** and press **MENU/OK**.

The TV displays, "Are you sure you would like to Restore Defaults? This will erase any custom settings."

4. Highlight **Yes** and press **MENU/OK**.
5. Press **EXIT**.

## Restarting the Setup App

The TV's Setup App can be used to easily set up the TV tuner.

To access the Setup App:

1. Press the **MENU** button on the remote. The on-screen menu is displayed.
2. Use the **Arrow** buttons on the remote to highlight the **Help** icon and press **MENU/OK**. The Help menu is displayed.
3. Highlight **Start Setup Wizard** and press **MENU/OK**.
4. Use the Number Pad to enter your parental PIN. If you have not yet set your PIN, enter **0000**.
5. The TV displays, "Are you sure you want to RESET SETUP WIZARD?"

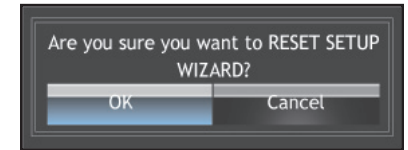

Highlight **OK** and press **MENU/OK**.

## USING THE USB MEDIA PLAYER

The USB Media Player allows you to connect a USB thumb drive to your TV and play music or photos.

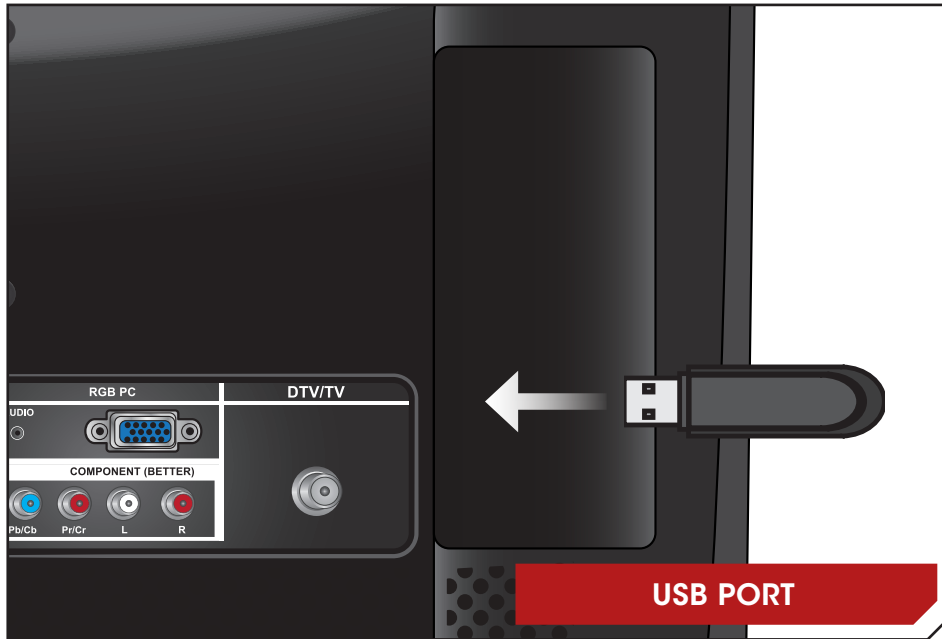

### Connecting a USB Thumb Drive to the TV

1. Turn the TV off. Connect your USB thumb drive to the USB port on the side of the TV.
2. Press the **Power/Standby** button on the remote or touch the **Power** control on the side of the TV to turn it on.

Media Type	File Types
Images	.jpeg .jpg

### Viewing a USB Photo Slideshow

To play a Photo Slideshow, you must first save your images onto a USB thumb drive.

Remember:

- The USB thumb drive must be formatted as FAT32
- Files on the USB thumb drive must be a supported file type
- The USB thumb drive must have a minimum 1GB memory
- The TV will not play media from external hard drives or mp3 players

To play your USB media:

1. Load your photos onto a USB thumb drive using your home computer.
2. Insert the USB thumb drive into the USB port on the left side of the TV. The photos on your USB thumb drive will be displayed automatically.

If your thumb drive is already inserted, continue with step 3.

3. Press the **MENU** button on the remote. The on-screen menu is displayed.
4. Use the **Arrow** buttons on the remote to highlight the **Photo** icon and press **MENU/OK**. The Photo screen is displayed.
5. Use the **Arrow** buttons on the remote to highlight the photo you would like to be displayed first, then press the **Play** button. The slideshow begins.
6. To pause the slideshow, press the **Pause** button.
7. To go to the previous photo, press the **Stop** button.
8. To exit the slideshow, press the **EXIT** button.

**Current Folder**

Displays the folder path.

**Folder Contents**

This area displays the contents of the currently selected folder. You can browse between files using the **Arrow** and **OK** buttons on the remote.

**Pause**

Press the **Pause** button on the remote control if you would like to pause the Photo Slideshow.

**Next**

Press the **Play** button on the remote control if you would like to start the Photo Slideshow.

**Previous**

Press the **Stop** button on the remote control if you would like to return to the previous screen.

**Exit**

Press the **Exit** button on the remote control if you would like to exit the Photo selection screen.

**PHOTO VIEWER**

DO YOU HAVE QUESTIONS?

# LET US HELP!

YOUR PRODUCT INCLUDES FREE LIFETIME TECH SUPPORT



The VIZIO support team is highly trained and is based in the United States.

We can help with:

- New Product Setup
- Connecting Your Devices
- Technical Problems
- And More

Phone: (877) 878-4946 (TOLL-FREE)

Email: [techsupport@VIZIO.com](mailto:techsupport@VIZIO.com)

Web: [www.VIZIO.com/support](http://www.VIZIO.com/support)

Hours of operation:

Monday - Friday: 5 AM TO 9 PM (PST)

Saturday - Sunday: 8 AM TO 4 PM (PST)

**We speak English • Se habla Español • Nous parlons Français**

**The TV displays “No Signal.”**

- Press the **INPUT** button on the remote control to select a different input source.
- If you are using cable TV, satellite, or antenna connected directly to the TV, scan for channels. See *Scanning for Channels* on page 30.

**There is no power.**

- Ensure the TV is plugged into a working electrical outlet.
- Ensure the power cable is securely attached to the TV.

**The power is on, but there is no image on the screen.**

- Ensure all cables are securely attached to the TV.
- Ensure all devices are connected correctly. Devices differ; see your device’s user manual for details.
- Adjust Brightness, Contrast, or Backlight. See *Adjusting the Picture Settings* on page 20.
- Press the INPUT button on the remote to select a different input source.

**There is no sound.**

- Press **Volume Up** on the remote control.
- Press the **MUTE** button on the remote to ensure mute is off.
- Check the audio settings. See *Adjusting the Audio Settings* on page 23. Ensure the speakers are set to On.
- Ensure no headphones are connected to the TV.
- Check the audio connections of external devices (Blu-ray player, game console, cable/satellite box) that are connected to the TV.
- If you are using an antenna, the signal strength of the channel may be low. Ensure your antenna is connected securely to the TV and move the antenna around the room or close to a window for the best signal.

**The colors on the TV don’t look right.**

- Adjust the Color and Tint settings in the Picture menu. See *Adjusting the Picture Settings* on page 20.
- Reset the picture settings. See *Resetting the Picture Settings* on page 23.
- Check all cables to ensure they are securely attached.

**The buttons on the remote aren’t working.**

- Ensure you are only pressing one button at a time.
- Point the remote directly at the TV when pressing a button.
- Replace the remote batteries with new ones. See *Replacing the Batteries* on page 11.

**The image quality is not good.**

- For the best image quality, view high-definition programs using digital sources. Connect your devices with HDMI cables.
- If you are using an antenna, the signal strength of the channel may be low. Ensure your antenna is connected securely to the TV and move the antenna around the room or close to a window for the best signal.

**The picture is distorted.**

- Nearby electrical devices may be interfering with the TV. Separate the TV from electrical appliances, cars, or fluorescent lights.
- Ensure all cables are securely attached.

**The display image does not cover the entire screen.**

- If you are in RGB mode (computer), ensure that H-Size and V-Position in the on-screen menu are set correctly.
- If you are using TV, AV1, AV2, or Component with 480i input, press the WIDE button on the remote to change the screen mode.

**The TV has pixels (dots) that are always dark or always lit.**

- Your HDTV is precision-manufactured using an extremely high level of technology. However, sometimes pixels may not display correctly. These types of occurrences are inherent to this type of product and do not constitute a defective product.

**I see "noise" or static on the screen.**

- When your TV's digital capabilities exceed a digital broadcast signal, the signal is up-converted (improved) to match your TV's display capabilities. This up-converting can sometimes cause irregularities in the image.
- If you are using an antenna, the signal strength of the channel may be low. Ensure your antenna is connected securely to the TV and move the antenna around the room or close to a window for the best signal.

**When I change input source, the volume changes.**

- The TV remembers the volume level on each input source. If the volume level on the new input source is higher or lower than the level on the source you switch from, the difference may be noticeable.
- Use the Volume Up/Down buttons on the remote to adjust the volume.

**When I change input source, the display image changes size.**

- The TV remembers the viewing mode on each input source. If the viewing mode on the new input source differs from the one on the input source you switch from, the difference may be noticeable.
- See *Changing the Screen Aspect Ratio* on page 18.



	<b>E191VA</b>	<b>E221VA</b>	<b>E261VA</b>
<b>Screen Size:</b>	19" Class	22" Class	26" Class
<b>Viewable Area:</b>	18.5"	21.5"	26"
<b>Dimensions w/ Stand:</b>	18.01 x 12.54 x 4.28"	20.63 x 14.09 x 5.10"	25.35 x 17.01 x 5.87"
<b>w/o Stand:</b>	18.01 x 12.54 x 1.54"	20.63 x 14.09 x 1.54"	25.35 x 17.01 x 1.54"
<b>Weight w/ Stand:</b>	8.09 lbs	9.26 lbs	13.12 lbs
<b>w/o Stand:</b>	7.32 lbs	8.16 lbs	11.75 lbs
<b>TV Type:</b>	Edge-lit Razor LED™	Edge-lit Razor LED™	Edge-lit Razor LED™
<b>Refresh Rate:</b>	60 Hz	60 Hz	60 Hz
<b>Maximum Resolution:</b>	1366 x 768	1920 x 1080	1366 x 768
<b>Colors:</b>	16.7 Million	16.7 Million	16.7 Million
<b>Response Time:</b>	<5 ms	<5 ms	<5 ms
<b>Brightness:</b>	250 nits	250 nts	300 nits
<b>Viewing Angle:</b>	170° H, 160° V	170° H, 160° V	160° H, 150° V
<b>HDMI Inputs:</b>	1	1	2
<b>Component Video Inputs:</b>	1	1	1
<b>Composite Inputs:</b>	1 (Shared with Component)	1 (Shared with Component)	1
<b>RF Antenna Input:</b>	1	1	1
<b>USB 2.0 Ports:</b>	1	1	1
<b>USB Photo Slideshow:</b>	Yes	Yes	Yes
<b>USB Individual Photo:</b>	Yes	Yes	Yes

	<b>E191VA</b>	<b>E221VA</b>	<b>E261VA</b>
<b>USB Video Playback:</b>	No	No	No
<b>USB Music Player:</b>	No	No	No
<b>RGB Inputs:</b>	1	1	1
<b>OSD Language:</b>	English, Spanish, French	English, Spanish, French	English, Spanish, French
<b>Ambient Light Sensor:</b>	Yes	Yes	Yes
<b>Remote Control Model:</b>	XRT010	XRT010	XRT010
<b>Certifications:</b>	UL, CUL, FCC class B, Canada (BETS-7), HDMI 1.4 incl CEC/ARC, Dolby Digital	UL, CUL, FCC class B, Canada (BETS-7), HDMI 1.4 incl CEC/ARC, Dolby Digital	UL, CUL, FCC class B, Canada (BETS-7), HDMI 1.4 incl CEC/ARC, Dolby Digital
<b>Compliance:</b>	Energy Star 5.3, ATSC Spec A/65. EIA/CEA-766-A, California Energy Commission Auto Shut Down	Energy Star 5.3, ATSC Spec A/65. EIA/CEA-766-A, California Energy Commission Auto Shut Down	Energy Star 5.3, ATSC Spec A/65. EIA/CEA-766-A, California Energy Commission Auto Shut Down
<b>Power Consumption:</b>	19.7W	22.5W	33.8W
<b>Standby Power:</b>	<1W	<1W	<1W

## ON PARTS AND LABOR

Covers units purchased as new in United States and Puerto Rico Only. VIZIO provides a warranty to the original purchaser of a new Product against defects in materials and workmanship for a period of one (1) year of non-commercial usage and ninety (90) days of commercial use. If a Product covered by this warranty is determined to be defective within the warranty period, VIZIO will either repair or replace the Product at its sole option and discretion.

To obtain warranty service, contact VIZIO Technical Support via e-mail: TechSupport@VIZIO.com or via phone at 877 MY VIZIO (877.698.4946) from 6:00AM to 9:00PM Monday through Friday and 8:00AM to 4:00PM Saturday and Sunday, Pacific Time, or visit [www.VIZIO.com](http://www.VIZIO.com). PRE-AUTHORIZATION MUST BE OBTAINED BEFORE SENDING ANY PRODUCT TO A VIZIO SERVICE CENTER. Proof of purchase in the form of a purchase receipt or copy thereof is required to show that a Product is within the warranty period.

## Parts and Labor

There will be no charge for parts or labor during the warranty period. Replacement parts and Products may be new or recertified at VIZIO's option and sole discretion. Replacement parts and Products are warranted for the remaining portion of the original warranty or for ninety (90) days from warranty service or replacement, whichever is greater.

## Type of Service

Defective Products must be sent to a VIZIO service center to obtain warranty service. VIZIO is not responsible for transportation costs to the service center, but VIZIO will cover return shipping to the customer. PRE-AUTHORIZATION IS REQUIRED BEFORE SENDING ANY PRODUCT TO A VIZIO SERVICE CENTER FOR WARRANTY SERVICE.

Product returns to VIZIO's service centers must utilize either the original carton box and shipping material or packaging that affords an equal degree of protection. VIZIO Technical Support will provide instructions for packing and shipping the covered Product to the VIZIO service center.

## Limitations and Exclusions

VIZIO's one-year limited warranty only covers defects in materials and workmanship. This warranty does not cover, for example: cosmetic damage, normal wear and tear, improper operation, improper voltage supply or power surges, signal issues, damages from shipping, acts of God, any type of customer misuse, modifications or adjustments, as well as installation and set-up issues or any repairs attempted by anyone

other than by a VIZIO authorized service center. Products with unreadable or removed serial numbers, or requiring routine maintenance are not covered. This one year limited warranty does not cover Products sold "AS IS", "FACTORY RECERTIFIED", or by a non-authorized reseller.

THERE ARE NO EXPRESS WARRANTIES OTHER THAN THOSE LISTED OR DESCRIBED ABOVE. ANY IMPLIED WARRANTIES, INCLUDING ANY IMPLIED WARRANTY OF MERCHANTABILITY AND FITNESS FOR A PARTICULAR PURPOSE, SHALL BE LIMITED IN DURATION TO THE PERIOD OF TIME SET FORTH ABOVE. VIZIO'S TOTAL LIABILITY FOR ANY AND ALL LOSSES AND DAMAGES RESULTING FROM ANY CAUSE WHATSOEVER INCLUDING VIZIO'S NEGLIGENCE, ALLEGED DAMAGE, OR DEFECTIVE GOODS, WHETHER SUCH DEFECTS ARE DISCOVERABLE OR LATENT, SHALL IN NO EVENT EXCEED THE PURCHASE PRICE OF THE PRODUCT. VIZIO SHALL NOT BE RESPONSIBLE FOR LOSS OF USE, LOSS OF INFORMATION OR DATA, COMMERCIAL LOSS, LOST REVENUE OR LOST PROFITS, OR OTHER INCIDENTAL OR CONSEQUENTIAL DAMAGES. SOME STATES DO NOT ALLOW LIMITATIONS ON HOW LONG AN IMPLIED WARRANTY LASTS OR THE EXCLUSION OF INCIDENTAL OR CONSEQUENTIAL DAMAGES, SO THE ABOVE LIMITATIONS OR EXCLUSIONS MAY NOT APPLY TO YOU. THIS WARRANTY GIVES YOU SPECIFIC LEGAL RIGHTS, AND YOU MAY ALSO HAVE OTHER RIGHTS, WHICH VARY FROM STATE TO STATE. THIS WARRANTY IS SUBJECT TO CHANGE WITHOUT NOTICE.

CHECK [WWW.VIZIO.COM](http://WWW.VIZIO.COM) FOR THE MOST CURRENT VERSION.

## Personal Data

If your VIZIO product is capable of storing personal data and other information, ALL CONTENTS AND INFORMATION WILL BE DELETED IN THE COURSE OF SOME IN-HOME AND ALL SHIP-IN WARRANTY SERVICE. If this occurs, your product will be restored to you configured as originally purchased. You will be responsible for restoring all applicable data and passwords. Recovery and reinstallation of user data is not covered under this Limited Warranty. In order to protect your personal information, VIZIO recommends that you always clear all personal information from the unit before it is serviced, regardless of the servicer.

## Zero Bright Pixel Defect Guarantee

This policy covers "zero bright pixel" defects for the duration of the limited "ONE YEAR WARRANTY" on select new product purchases. To determine if this guarantee applies to your product, refer to the "DETAILS" tab of the model's product information page ([www.VIZIO.com](http://www.VIZIO.com)) or look for the "zero bright pixel" guarantee on the box.



## **FCC Class B Radio Interference Statement**

NOTE: This equipment has been tested and found to comply with the limits for a Class B digital device, pursuant to Part 15 of the FCC Rules. These limits are designed to provide reasonable protection against harmful interference in a residential installation. This equipment generates, uses and can radiate radio frequency energy, and if not installed and used in accordance with the instructions, may cause harmful interference to radio communications. However, there is no guarantee that interference will not occur in a particular installation. If this equipment does cause harmful interference to radio or television reception, which can be determined by turning the equipment off and on, the user is encouraged to try to correct the interference by one or more of the following measures:

1. Reorient or relocate the receiving antenna.
2. Increase the separation between the equipment and receiver.
3. Connect the equipment into an outlet on a circuit different from that to which the receiver is connected.
4. Consult the dealer or an experienced radio/TV technician for help.

This device complies with Part 15 of the FCC Rules. Operation is subject to the following two conditions: (1) this device may not cause harmful interference, and (2) this device must accept any interference received, including interference that may cause undesired operation.

## **Notice**

1. The changes or modifications not expressly approved by the party responsible for compliance could void the user's authority to operate the equipment.
2. Shielded interface cables and AC power cord, if any, must be used in order to comply with the emission limits.
3. The manufacturer is not responsible for any radio or TV interference caused by unauthorized modification to this equipment. It is the responsibilities of the user to correct such interference.

## **FCC warning**

Changes or modifications not expressly approved by the party responsible for compliance with the FCC Rules could void the user's authority to operate this equipment.

VIZIO

## Free Manuals Download Website

<http://myh66.com>

<http://usermanuals.us>

<http://www.somanuals.com>

<http://www.4manuals.cc>

<http://www.manual-lib.com>

<http://www.404manual.com>

<http://www.luxmanual.com>

<http://aubethermostatmanual.com>

Golf course search by state

<http://golfingnear.com>

Email search by domain

<http://emailbydomain.com>

Auto manuals search

<http://auto.somanuals.com>

TV manuals search

<http://tv.somanuals.com>