

VIZIO



# HOME THEATER 32" SOUND BAR

MODEL VSB206

**QUICK START GUIDE**

# IMPORTANT SAFETY INFORMATION

**Your Sound Bar is designed and manufactured to operate within defined design limits, and misuse may result in electric shock or fire. To prevent your Sound Bar from being damaged, the following rules should be observed for its installation, use, and maintenance. Please read the following safety instructions before operating your Sound Bar. Keep these instructions in a safe place for future reference.**

- To reduce the risk of electric shock or component damage, switch off the power before connecting other components to your Sound Bar.
- Unplug the power cord before cleaning your Sound Bar. A damp cloth is sufficient for cleaning. Do not use a liquid or a spray cleaner on your Sound Bar. Do not use abrasive cleaners.
- Always use the accessories recommended by the manufacturer to insure compatibility.
- When moving your Sound Bar from an area of low temperature to an area of high temperature, condensation may form in the housing. Wait before turning on your Sound Bar to avoid causing fire, electric shock, or component damage.
- A distance of at least 3 feet should be maintained between your Sound Bar and any heat source, such as a radiator, heater, oven, amplifier etc. Do not install your Sound Bar close to smoke. Operating your Sound Bar close to smoke or moisture may cause fire or electric shock.
- Slots and openings in the back and bottom of the cabinet are provided for ventilation. To ensure reliable operation of your Sound Bar and to protect it from overheating, be sure these openings are not blocked or covered. Do not place your Sound Bar in a bookcase or cabinet unless proper ventilation is provided.
- Never push any object into the slots and openings on your Sound Bar enclosure. Do not place any objects on the top of your Sound Bar. Doing so could short circuit parts causing a fire or electric shock. Never spill liquids on your Sound Bar.
- Your Sound Bar should be operated only from the type of power source indicated on the label on the AC/DC Adapters. If you are not sure of the type of power supplied to your home, consult your dealer or local power company.
- Only power of the marked voltage can be used for your Sound Bar. Any other voltage than the specified voltage may cause fire or electric shock
- The power cord must be replaced when using different voltage than the voltage specified. For more information, contact your dealer.
- Your Sound Bar AC/DC Adapters are equipped with a three-pronged grounded plug (a plug with a third grounding pin). This plug will fit only into a grounded power outlet. This is a safety feature. If your outlet does not accommodate the three-pronged, have an electrician install the correct outlet, or use an adapter to ground your Sound Bar safely.
- Do not defeat the safety purpose of the grounded plug.
- When connected to a power outlet, power is always flowing into your Sound Bar. To totally disconnect power, unplug the power cord.
- The lightning flash with arrowhead symbol within an equilateral triangle is intended to alert the user to the presence of un-isolated, dangerous voltage within your Sound Bar that may be of sufficient magnitude to constitute a risk



of electric shock to persons.

- The exclamation point within an equilateral triangle is intended to alert the user to the presence of important operating and servicing instructions in the literature accompanying your Sound Bar.
- Do not overload power strips and extension cords. Overloading can result in fire or electric shock.
- The wall socket should be located near your Sound Bar and be easily accessible
- Do not touch the power cord during lightning. To avoid electric shock, avoid handling the power cord during electrical storms.
- Unplug your Sound Bar during a lightning storm or when it will not be used for long periods of time. This will protect your Sound Bar from damage due to power surges.
- Do not attempt to repair or service Sound Bar yourself. Opening or removing the front cover may expose you to high voltages, electric shock, and other hazards. If repair is required, contact your dealer and refer all servicing to qualified service personnel.
- Keep your Sound Bar away from moisture. Do not expose your Sound Bar to rain or moisture. If water penetrates into your Sound Bar, unplug the power cord and contact your dealer. Continuous use in this case may result in fire or electric shock.
- Do not use your Sound Bar if any abnormality occurs. If any smoke or odor becomes apparent, unplug the power cord and contact your dealer immediately. Do not try to repair your Sound Bar yourself.
- Avoid using dropped or damaged appliances. If your Sound Bar is dropped and the housing is damaged, the internal components may function abnormally. Unplug the power cord immediately and contact your dealer for repair. Continued use of your Sound Bar may cause fire or electric shock.
- Do not install your Sound Bar in an area with heavy dust or high humidity. Operating your Sound Bar in environments with heavy dust or high humidity may cause fire or electric shock.
- Ensure that the power cord and any other cables are unplugged before moving your Sound Bar.
- When unplugging your Sound Bar, hold the power plug, not the cord. Pulling on the power cord may damage the wires inside the cord and cause fire or electric shock. When your Sound Bar will not be used for an extended period of time, unplug the power cord.
- To reduce risk of electric shock, do not touch the connector with wet hands.
- Insert the remote control battery in accordance with instructions. Incorrect polarity may cause the battery to leak which can damage the remote control or injure the operator.
- If any of the following occurs, contact the dealer:
  - The power cord fails or frays
  - Liquid sprays or any object drops into your Sound Bar
  - Sound Bar is exposed to rain or other moisture
  - Sound Bar is dropped or damaged in any way
  - The performance of your Sound Bar changes substantially



# PACKAGE CONTENTS



32" Home Theater Sound Bar



Power Adapter



Stereo RCA to 3.5mm Audio Cable



This Quick Start Guide



Remote Control with Battery

# CONTROLS & CONNECTIONS

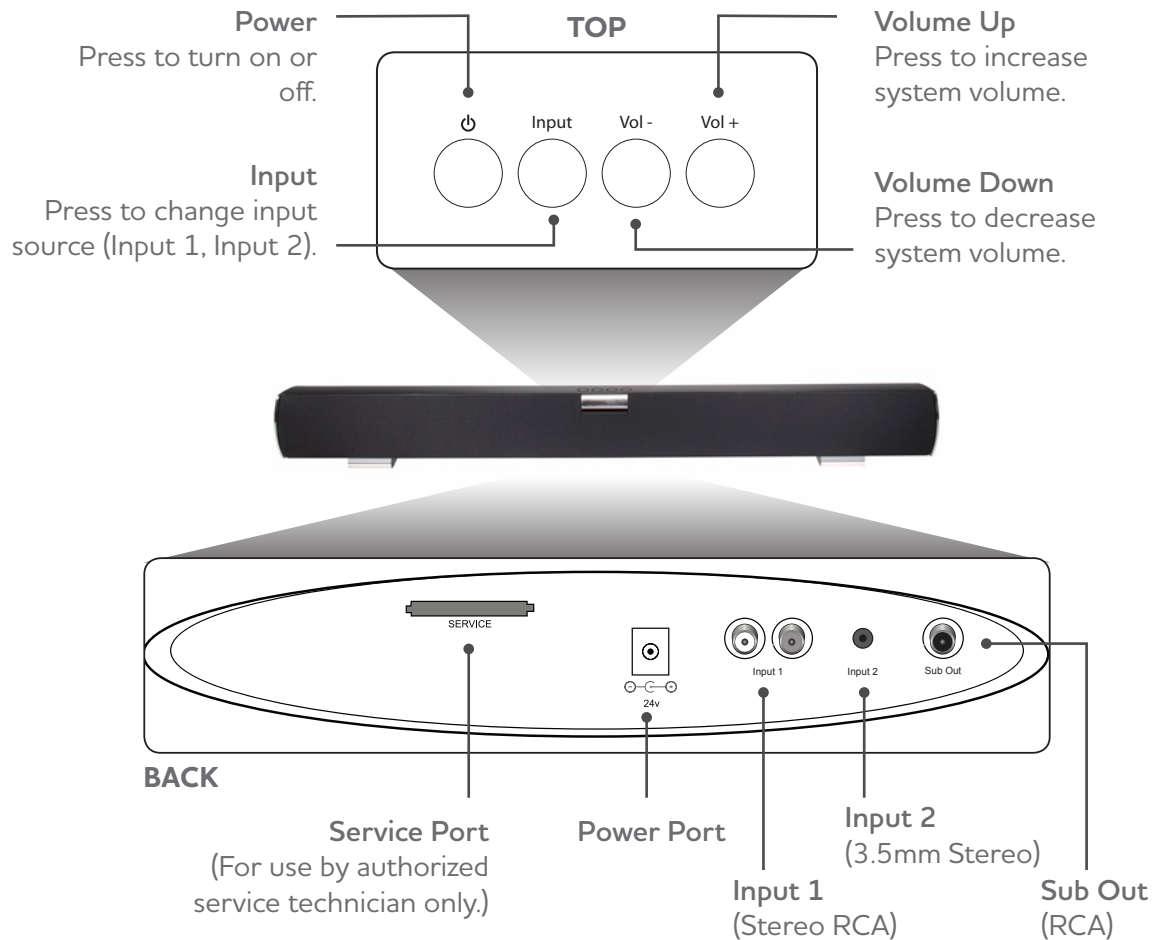



# FIRST-TIME SETUP

1

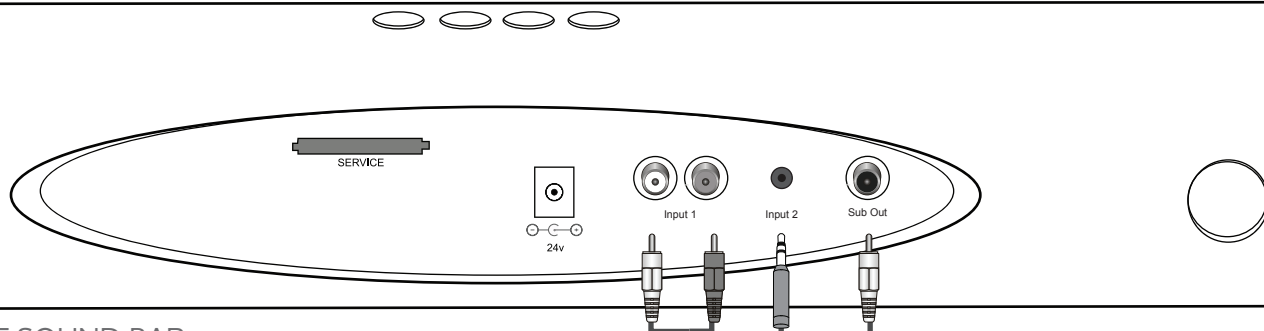

BACK OF SOUND BAR

Connect the included Stereo  
RCA to 3.5mm Cable to ONE TV  
audio output as shown.

CHOOSE ONE



This port might also be labeled  
Headphone, HP, or Line Out



BACK OF YOUR TV

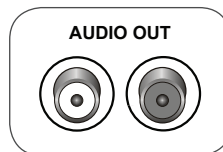

**OPTIONAL:** For extra bass,  
connect an RCA cable (not  
included) to an external  
subwoofer. Extra bass  
makes explosions and music  
sound more powerful.

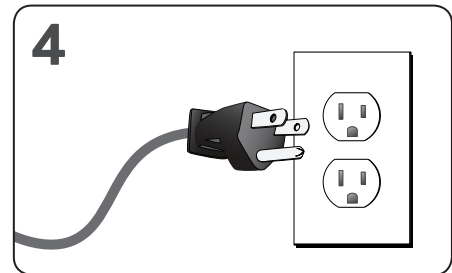
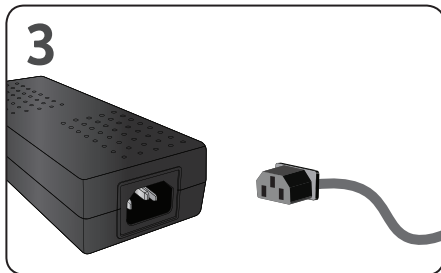
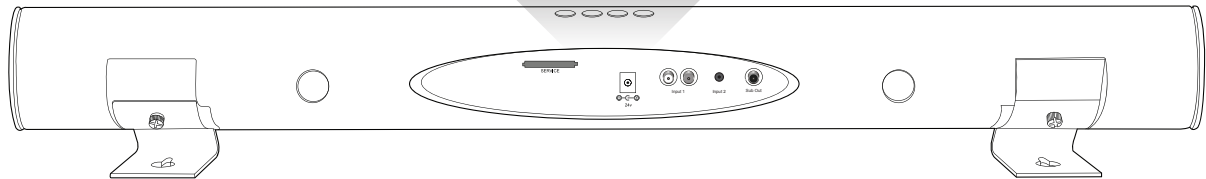
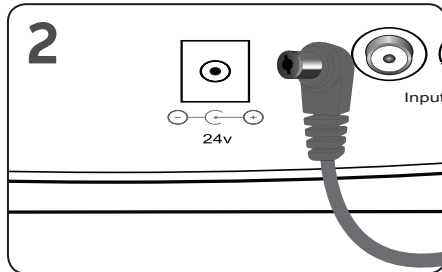

# 5

Gently pull the plastic tab from the back of the remote control. (The plastic tab can be thrown away.)

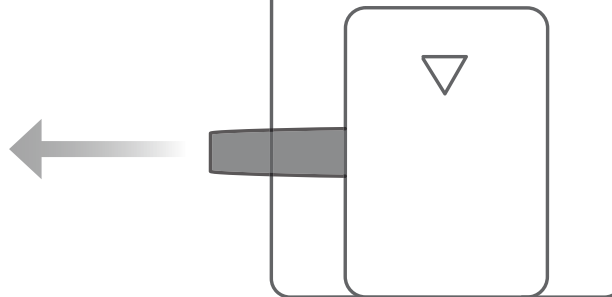

# 6

Turn your TV on, then press the Power button on the remote to turn the Sound Bar on.

Press the Input button to switch between the Input 1 and Input 2 audio sources. For example, if you connected your TV to Input 1, set the Sound Bar to Input 1.

Setup is complete.

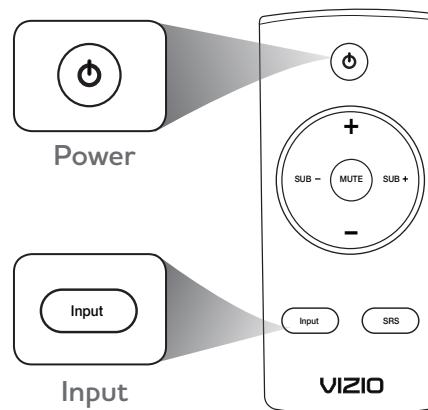

# USING THE REMOTE

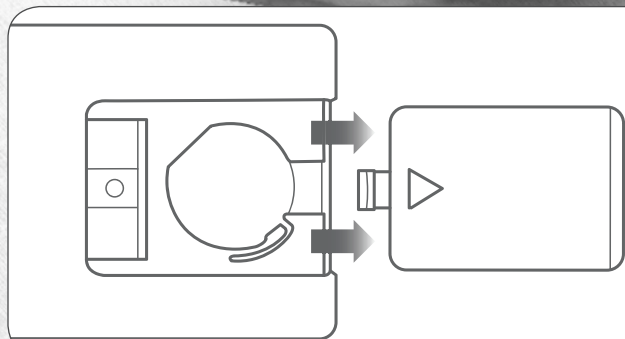
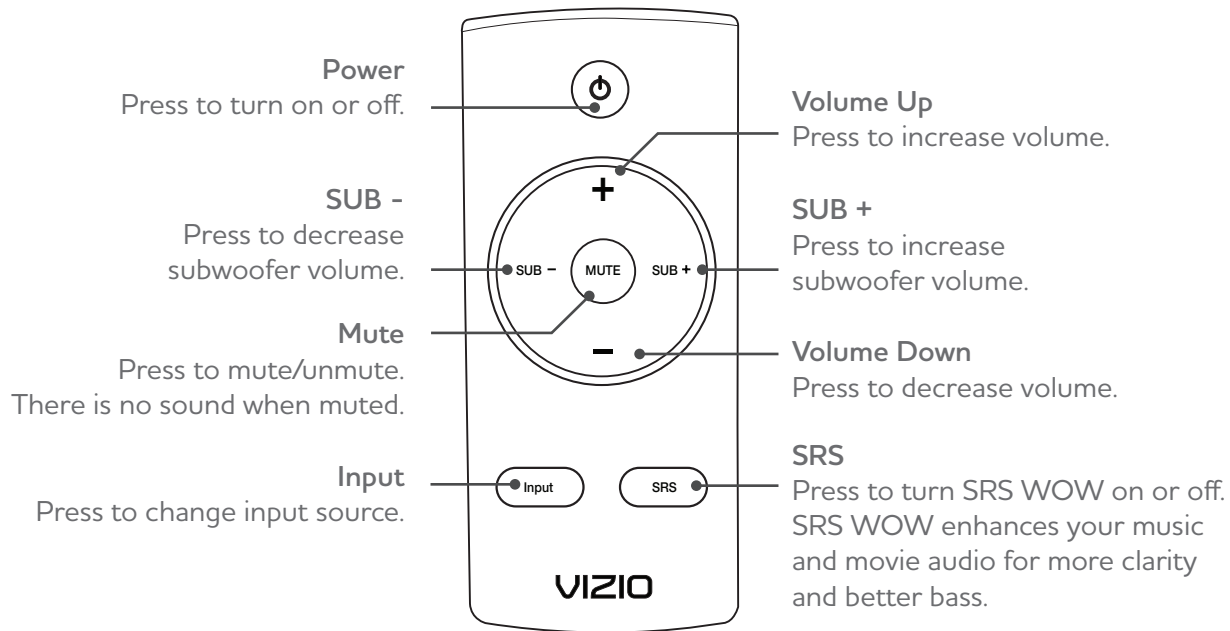

If your remote stops responding, you may need to replace the battery.

To replace the battery, remove the cover from the back of the remote as shown, then replace the old battery with a new CR2025. Be sure that the + sign on the battery is facing up.



# WALL MOUNTING THE SOUND BAR

**1**

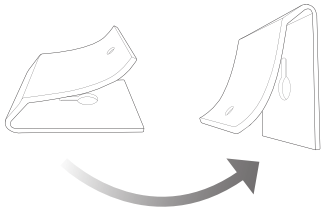

Remove the screw from the Sound Bar stands and rotate as shown.

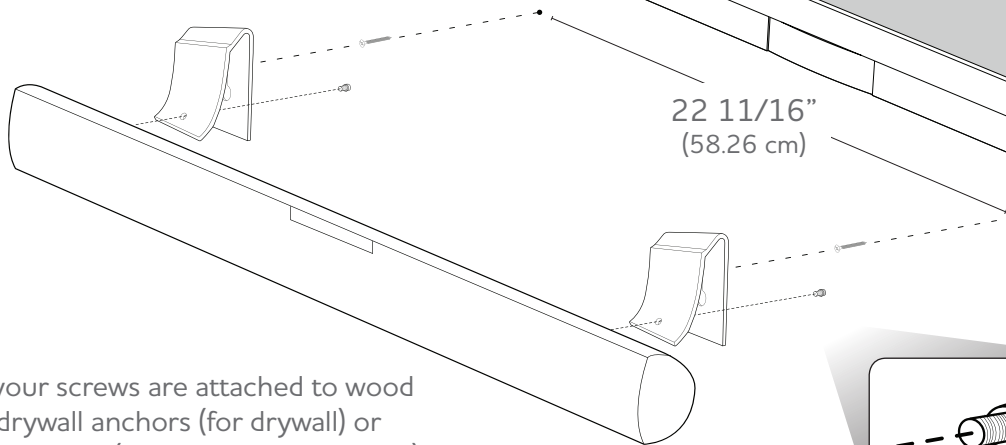

**2** Be sure your screws are attached to wood studs or drywall anchors (for drywall) or concrete anchors (for brick/concrete walls).



If you are unfamiliar with power tools or the layout of electrical wiring in the walls of your home, consult a professional installer.

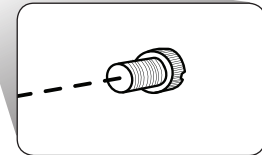

Reattach stands using the included screw.

# LET US HELP!

**YOUR PRODUCT INCLUDES FREE LIFETIME TECH SUPPORT**

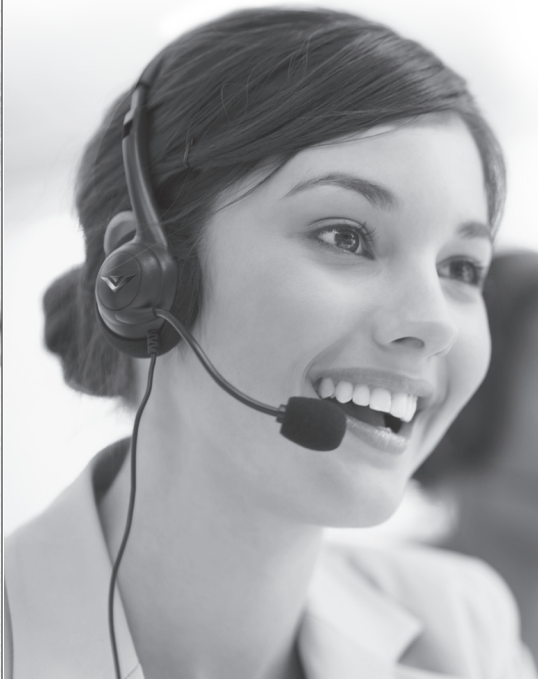

The VIZIO support team is highly trained and is based in the United States.

We can help with:

- Product Setup
- Technical Problems
- Warranty Questions
- And More

**Phone:** (877) 878-4946 (TOLL-FREE)

**Email:** [techsupport@VIZIO.com](mailto:techsupport@VIZIO.com)

**Web:** [www.VIZIO.com/support](http://www.VIZIO.com/support)

**Hours of operation:**

Monday - Friday: 5 AM TO 9 PM (PST)

Saturday - Sunday: 8 AM TO 4 PM (PST)

**We speak English • Se habla Español • Nous parlons Français**

**There is no power.**

- Press the **POWER** button on the remote control or on the top of your Sound Bar.
- Ensure the power cord is securely connected.
- Ensure the light on the power adapter is glowing green.
- Plug a different device into the electrical outlet to verify that the outlet is working correctly.

**There is no sound.**

- Increase the volume. Press **Volume Up** on the remote control or on the top of your Sound Bar.
- Press **MUTE** on the remote to ensure the Sound Bar is not muted.
- Press **INPUT** on the remote or on the top of your Sound Bar to select a different input source.
- If you are using the 3.5mm output from your TV, be sure that is connected to an audio **OUTPUT** and not audio **INPUT**. Some TVs use 3.5mm audio **INPUT** for devices such as computers.
- Your TV may be set to variable audio output. Confirm that the audio output setting is set to **FIXED** or **STANDARD**, not **VARIABLE**. Consult your TV's user manual for more detailed information.

**I hear buzzing or humming.**

- Ensure all cables and wires are securely connected.
- Connect a different source device (TV, Blu-ray player, etc) to see if the buzzing persists. If it does not, the problem may be with the original device.
- Connect your device to a different input on the Sound Bar.

**There is no bass.**

- Press the **SUB +** button on the remote control to increase the bass level.
- Adjust the bass volume on your subwoofer.

**There is too much bass.**

- Press the **SUB -** button on the remote control to decrease the bass level.
- Adjust the bass volume on your subwoofer.

# VIZIO RECOMMENDS



Complete your home theater experience! The VIZIO Blu-ray Player with Wireless Internet Apps delivers full 1080p HD video, 7.1 surround sound and has built-in 802.11n dual-band wireless for easy access to movies, TV shows, music and more from the Internet.

- Exceptional Full HD 1080p performance
- Streams movies, music, and more with VIZIO Wireless Internet Apps
- Built-in Wi-Fi 802.11n



Keep entertainment freedom at your fingertips – it's your movies, TV shows, and music in a thin, ultralight design. Stay ahead of the game with essential apps like email, calendar, and news. Part of the VIZIO Internet Apps® Plus ecosystem, the VIZIO Tablet redefines entertainment with more choice, more fun, more freedom for all.

- Elegant, Easy-to-Use VIZIO Internet Apps Plus User Interface
- 802.11n WiFi for High-Speed Wireless Internet
- Choose From Over 150,000 Apps in Android Market



# ONE-YEAR LIMITED WARRANTY

## ON PARTS AND LABOR

### Covers units purchased as new in United States and Puerto Rico Only

VIZIO provides a warranty to the original purchaser of a new Product against defects in materials and workmanship for a period of one year of non-commercial usage and ninety (90) days of commercial use. If a Product covered by this warranty is determined to be defective within the warranty period, VIZIO will either repair or replace the Product at its sole option and discretion.

To obtain warranty service, contact VIZIO Technical Support via email: TechSupport@VIZIO.com or via phone at 877 MY VIZIO (877.698.4946) from 6:00AM to 9:00PM Monday through Friday and 8:00AM to 4:00PM Saturday and Sunday, Pacific Time, or visit [www.VIZIO.com](http://www.VIZIO.com). PRE-AUTHORIZATION MUST BE OBTAINED BEFORE SENDING ANY PRODUCT TO A VIZIO SERVICE CENTER. Proof of purchase in the form of a purchase receipt or copy thereof is required to show that a Product is within the warranty period.

### Parts and Labor

There will be no charge for parts or labor during the warranty period. Replacement parts and Products may be new or recertified at VIZIO's option and sole discretion. Replacement parts and Products are warranted for the remaining portion of the original warranty or for ninety (90) days from warranty service or replacement, whichever is greater.

### Type of Service

Defective Products must be sent to a VIZIO service center to obtain warranty service. VIZIO is not responsible for transportation costs to the service center, but VIZIO will cover return shipping to the customer. PRE-AUTHORIZATION IS REQUIRED BEFORE SENDING ANY PRODUCT TO A VIZIO SERVICE CENTER FOR WARRANTY SERVICE.

Product returns to VIZIO's service centers must utilize either the original carton box and shipping material or packaging that affords an equal degree of protection. VIZIO Technical Support will provide instructions for packing and shipping the covered Product to the VIZIO service center.

### Limitations and Exclusions

VIZIO's one-year limited warranty only covers defects in materials and workmanship. This warranty does not cover, for example: cosmetic damage, normal wear and tear, improper operation, improper voltage supply or power surges, signal issues, damages from shipping, acts of God, any type of customer misuse, modifications or adjustments, as well as installation and set-up issues or any repairs attempted by anyone other than by a VIZIO authorized service center. Products with unreadable or removed serial numbers, or requiring routine maintenance are not covered. This one year limited warranty does not cover Products sold "AS IS", "FACTORY RECERTIFIED", or by a non-authorized reseller.

THERE ARE NO EXPRESS WARRANTIES OTHER THAN THOSE LISTED OR DESCRIBED ABOVE. ANY IMPLIED WARRANTIES, INCLUDING ANY IMPLIED WARRANTY OF MERCHANTABILITY AND FITNESS FOR A PARTICULAR PURPOSE, SHALL BE LIMITED IN DURATION TO THE PERIOD OF TIME SET FORTH ABOVE. VIZIO'S TOTAL LIABILITY FOR ANY AND ALL LOSSES AND DAMAGES RESULTING FROM ANY CAUSE WHATSOEVER INCLUDING VIZIO'S NEGLIGENCE, ALLEGED DAMAGE, OR DEFECTIVE GOODS, WHETHER SUCH DEFECTS ARE DISCOVERABLE OR LATENT, SHALL IN NO EVENT EXCEED THE PURCHASE PRICE OF THE PRODUCT. VIZIO SHALL NOT BE RESPONSIBLE FOR LOSS OF USE, LOSS OF INFORMATION OR DATA, COMMERCIAL LOSS, LOST REVENUE OR LOST PROFITS, OR OTHER INCIDENTAL OR CONSEQUENTIAL DAMAGES. SOME STATES DO NOT ALLOW LIMITATIONS ON HOW LONG AN IMPLIED WARRANTY LASTS OR THE EXCLUSION OF INCIDENTAL OR CONSEQUENTIAL DAMAGES, SO THE ABOVE LIMITATIONS OR EXCLUSIONS MAY NOT APPLY TO YOU. THIS WARRANTY GIVES YOU SPECIFIC LEGAL RIGHTS, AND YOU MAY ALSO HAVE OTHER RIGHTS, WHICH VARY FROM STATE TO STATE. THIS WARRANTY IS SUBJECT TO CHANGE WITHOUT NOTICE. CHECK [www.VIZIO.com](http://www.VIZIO.com) FOR THE MOST CURRENT VERSION.

# SPECIFICATIONS

**Sound Bar:** Four 2.75" High-Efficiency  
Hand-Built Full Range Transducers  
**Inputs:** 1 x 3.5mm Audio  
1 x RCA Stereo Audio

**Sound Pressure Level:** 98 dB

**Frequency Response:** 90Hz - 19 KHz

**Voltage:** 100-240 VAC, 50-60 Hz

**Dimensions:** 31.50" x 3.98" x 2.75" (with stand)  
31.50" x 3.20" x 2.75" (w/o stand)

**Net Weight:** 4.76 lbs (with stand)  
4.10 lbs (w/o stand)

**Gross Weight:** 6.98 lbs

**Compliances:** UL, FCC

### **FCC Class B Radio Interference Statement**

NOTE: This equipment has been tested and found to comply with the limits for a Class B digital device, pursuant to Part 15 of the FCC Rules. These limits are designed to provide reasonable protection against harmful interference in a residential installation. This equipment generates, uses and can radiate radio frequency energy, and if not installed and used in accordance with the instructions, may cause harmful interference to radio communications. However, there is no guarantee that interference will not occur in a particular installation. If this equipment does cause harmful interference to radio or television reception, which can be determined by turning the equipment off and on, the user is encouraged to try to correct the interference by one or more of the following measures:

1. Reorient or relocate the receiving antenna.
2. Increase the separation between the equipment and receiver.
3. Connect the equipment into an outlet on a circuit different from that to which the receiver is connected.
4. Consult the dealer or an experienced radio/TV technician for help.

This device complies with Part 15 of the FCC Rules. Operation is subject to the following two conditions: (1) this device may not cause harmful interference, and (2) this device must accept any interference received, including interference that may cause undesired operation.

### **Notice:**

1. The changes or modifications not expressly approved by the party responsible for compliance could void the user's authority to operate the equipment.
2. Shielded interface cables and AC power cord, if any, must be used in order to comply with the emission limits.
3. The manufacturer is not responsible for any radio or TV interference caused by unauthorized modification to this equipment. It is the responsibilities of the user to correct such interference.

### **RF Exposure Information**

This device meets the government's requirements for exposure to radio waves. This device is designed and manufactured not to exceed the emission limits for exposure to radio frequency (RF) energy set by the Federal Communications Commission of the U.S. Government. This device complies with FCC radiation exposure limits set forth for an uncontrolled environment.

### **IC Statement**

Operation is subject to the following two conditions:

1. This device may not cause interference, and
2. This device must accept any interference, including interference that may cause undesired operation of the device.

This Class B digital apparatus complies with Canadian ICES-003.

Cet appareil numérique de la classe B est conforme à la norme NMB-003 du Canada.

### **IC Radiation Exposure Statement**

This equipment complies with IC RSS-102 radiation exposure limits set forth for an uncontrolled environment. This equipment should be installed and operated with minimum distance 20cm between the radiator & your body.

### **Disposal and Recycling**

You must dispose of this product properly, according to local laws and regulations. Because this product contains electronic components and a battery, it must be disposed of separately from household waste. Contact local authorities to learn about disposal and recycling options.



Incorporated under license from SRS Labs, Inc.  
SRS WOW HD is a trademark of SRS Labs, Inc.



ENTERTAINMENT  
FREEDOM  
FOR ALL

© 2011 VIZIO INC. ALL RIGHTS RESERVED.

1102155T-NC

Download from [Www.Somanuals.com](http://Www.Somanuals.com). All Manuals Search And Download.

## Free Manuals Download Website

<http://myh66.com>

<http://usermanuals.us>

<http://www.somanuals.com>

<http://www.4manuals.cc>

<http://www.manual-lib.com>

<http://www.404manual.com>

<http://www.luxmanual.com>

<http://aubethermostatmanual.com>

Golf course search by state

<http://golfingnear.com>

Email search by domain

<http://emailbydomain.com>

Auto manuals search

<http://auto.somanuals.com>

TV manuals search

<http://tv.somanuals.com>