



Functions and Operating Instructions



TOA ELECTRIC CO., LTD.
KOBE, JAPAN

Contents

Introduction to the "Functions and Operating Instructions" for stations for EXES-6000	3
---	---

Chapter 1. Basic Functions, Their Operating Procedures and All Functions

1. Stations	4	5) Hands-free/Handset Master Station (HF-600M/610M/660M)	11
2. Speech Functions	5	6) Hands-free/Handset Substation (HF-600S/610S) ...	13
3. Station Operation		7) Hands-free/Handset Master Station with Auto-dialer (HF-660M)	15
1) Handset Master Station (TL-600M)	6	4. Functions: EXES-6000 CP-64	15
2) Handset Substation (TL-600S)	6		
3) Hands-free Master Station (HF-620M/630M/631M/650M)	7		
4) Hands-free Substation (HF-620S/630S/631S/640S)	9		

Chapter 2. Functions and Operating Procedures of Single Exchange System for a Maximum of 256 Stations

1. Part Names and Functions of the Station Keyboard ...	18	21) Conference	39
2. Function Description	19	22) Paging	40
3. EXES-6000 CP-64 Summary of Dial Operations (For Single Exchange)	21	23) Other Paging Modes	41
4. Description of Each Function		24) How to Select the Paging Area and Make the Paging Call	42
1) Automatic Line Release	23	25) All-Call Paging and Individual Zone Paging	43
2) Camp-On-Busy	23	26) Combination Paging	44
3) Privacy	23	27) Emergency All-Call Paging	46
4) Camp-On-Privacy	24	28) Paging Priority	47
5) Press-To-Talk	24	29) Personal Number Paging	48
6) Mic Off	24	30) Selectable First Station Number	49
7) Press-To-Talk Control	25	31) Programmable Station Numbering	49
8) Single Digit Dialing	26	32) Group Blocking	50
9) Master Sub Relationship	27	33) Programmable Restricted Access for Stations	51
10) Automatic Access To Paging	27	34) Selectable Calling Tone	52
11) Personal Number Call	28	35) Selectable Paging Pre-Announcement Tone Duration	52
12) Continuous Calling Tone	29	36) Time-Out of Conversation	52
13) Remote Response	39	37) Time-Out of Paging Call	52
14) Call Transfer, Paging during Normal Call	31	38) In/Out Annunciation	53
15) Group Hunting	32	39) Destination Annunciation Indication	54
16) Secretary Transfer	33	40) Calling Party Indication [Lamp Type]	55
17) Call Forwarding	36	41) Calling Party Indication [Numerical Type]	56
18) Priority	37	42) Pocket Pager	57
19) Executive Priority	37	43) General Purpose Control	58
20) Highest Executive Priority	38	44) Simplified Paging	59
		45) Clear Entry and Conversation Over	59

**Chapter 3. Functions and Operating Procedures of Tie-Line
System for a Maximum of 768 Stations**

1. Part Names and Functions of the Station Keyboard ...	60	14) Secretary Transfer	77
2. Tie-Line Connections of Exchanges	61	15) Highest Executive Priority	80
3. Function Description	63	16) Conference	81
4. Restrictions Resulting from Tie-Line Connection	65	17) Paging	82
5. EXES-6000 CP-64 Summary of Dial Operations (For Tie-Line System)	66	18) How to Select the Paging Area and Make the Paging Call	83
6. Description of Each Function		19) All-Call Paging and Individual Zone Paging	84
1) Automatic Line Release	68	20) Selectable First Station Number of Each Exchange	85
2) Camp-On-Busy	68	21) Programmable Station Numbering	86
3) Privacy	68	22) Group Blocking	87
4) Camp-On-Privacy	69	23) Programmable Restricted Access for Stations	89
5) Press-To-Talk	69	24) Selectable Calling Tone	90
6) Single Digit Dialing	70	25) Selectable Paging Pre-Announcement Tone Duration	90
7) Master Sub Relationship	71	26) Time-Out of Conversation	90
8) Automatic Access To Paging	71	27) Time-Out of Paging Call	90
9) Personal Number Call	72	28) In/Out Annunciation	91
10) Continuous Calling Tone	73	29) Calling Party Indication [Lamp Type]	92
11) Remote Response	74	30) Pocket Pager	94
12) Call Transfer, Paging during Normal Calls	75	31) General Purpose Control	95
13) Group Hunting	76	32) Simplified Paging	97
		33) Clear Entry and Conversation Over	97

Introduction to the "Functions and Operating Instructions" for stations for EXES-6000

This handbook explains the functions and operating procedures of stations for TOA's EXES-6000 Intercom System using central processing unit CP-64 (for single exchange or tie-line system) and exchanges EX-630.

Designed for connection of up to 3 exchanges, the EXES-6000 system permits you to talk with the person in the remote area, and also to increase the number of stations which one (1) exchange cannot cover.

This handbook is comprised of the following 3 chapters:

Chapter 1. Basic functions, their operating procedures and all functions.

Chapter 2. Functions and operating procedures of single exchange system (a maximum of 256 stations).

Chapter 3. Functions and operating procedures of tie-line system (a maximum of 768 stations).

Refer to Chapters 1 and 2 for single exchange system and to Chapters 1 and 3 for tie-line system.

Please note that performances of some functions are restricted in the tie-line system.

You need not read all the instructions given in this handbook but it is necessary to read the instructions on those functions employed in your system. The following guidelines will help you select the pages that you should read.

Selecting different functions made available by placing the Privacy Switch in the "ON" position

The EXES-6000 System is designed to allow either "PV" typ operation (The system having Privacy function) or "NP" type (Without Privacy function) to be selected by turning on or off a switch inside the exchange. It is impossible to make one station the "NP" type and another the "PV" type in the same system.

The function provided when the Privacy switch is in the ON position is different between the "PV" and the "NP" type. Therefore, read the page marked **PV Type** if your system is of the "PV" type and the Page **NP Type** if it is of the "NP" type.

"PV" Type and "NP" Type

Type	Definition	Description
PV Type	System having Privacy function	<ol style="list-style-type: none"> 1. Privacy tone With the Privacy switch in the ON position, a brief Privacy tone sounds and any incoming call is refused. 2. The Handset Master/Substation may not be used in this system. If used, it is not called by a continuous calling tone but by a brief Privacy tone.
NP Type	System having no Privacy function	<ol style="list-style-type: none"> 1. Continuous calling tone A station with the Privacy switch may be called by the continuous calling tone when its Privacy switch is placed in the ON position. One touch dialing any key (1 through 9, 0, *, C) other than the PTT key or picking up the handset stops the calling tone and the stations is made ready to initiate the response to the call. 2. The Handset Master station without Privacy switch may be called by the continuous calling tone. Picking up the handset stops the calling tone and allows the conversation.

Note.

By programming, the continuous calling tone function may be made available to specific stations with the Privacy switch in the OFF position.

In this event, touch dialing any key (1 through 9, 0, *, C) other than the **PTT** key stops the calling tone and permits conversation.

This feature may be employed for the industrial type of station (Model HF-650M) or in the "PV" type system that needs to be continuously called.

Chapter 1

Basic functions, their operating procedures and all functions

Stations

- | | | | |
|----------------------|--|-----------------------|---|
| 1. TL-600M | Desk/Wall-Mounted Handset Master Station | 9. HF-620M | Desk/Wall-Mounted Hands-Free Master Station |
| 2. TL-600S | Desk/Wall-Mounted Handset Substation | 10. HF-620S | Desk/Wall-Mounted Hands-Free Substation |
| 3. HF-660M | Desk / Wall-Mounted Hands-Free / Handset Master Station with Auto-Dialer (8 keys — 16 registrations) | 11. HF-630M | Flush-Mounted Hands-Free Master Station |
| 4. AK-024 | Auto-Dialer Key Unit (24 keys) | 12. HF-630S | Flush-Mounted Hands-Free Substation |
| 5. HF-600M | Desk Hands-Free/Handset Master Station | 13. HF-631M | Flush-Mounted Hands-Free Master Station (Stainless steel panel) |
| 6. HF-600S | Desk Hands-Free / Handset Substation | 14. HF-631S | Flush-Mounted Hands-Free Substation (Stainless steel panel) |
| 7. HF-610M | Flush-Mounted Hands-Free/Handset Master Station | 15. HF-640S | Door Station (Hands-free) |
| 8. HF-610S | Flush-Mounted Hands-Free / Handset Substation | 16. HF-650M | Surface-Mounted Industrial Master Station (Hands-free) |

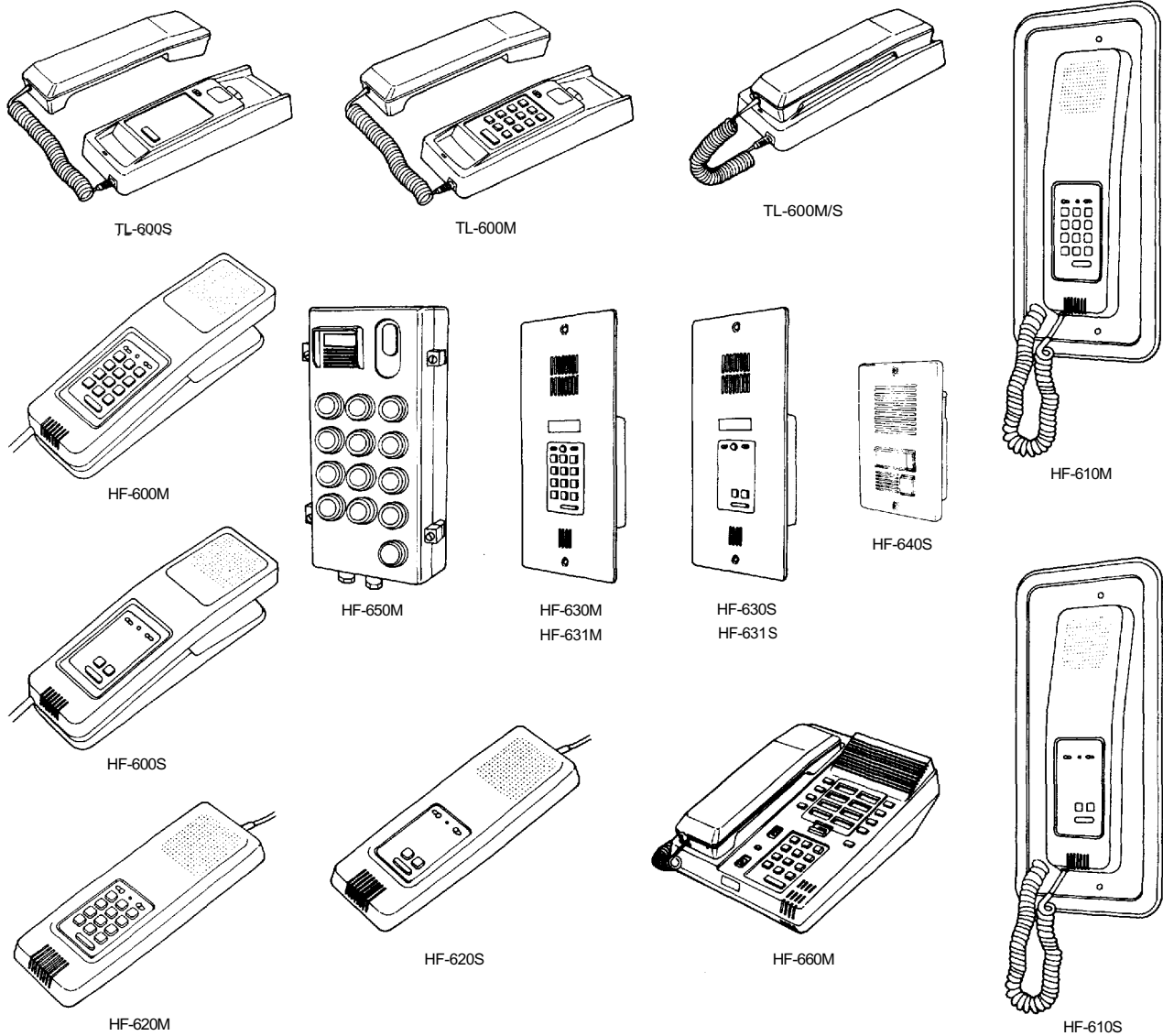

Speech functions

Either "PV" Type (the system with Privacy function) or "NP" Type (Without Privacy function) mode should be selected in the total intercom system.

When Privacy Switch (SW) of station is turned ON, privacy tone is available in "PV" Type system, while continuous calling tone is available in "NP" Type system.

	Functions	System types		Descriptions	Stations *2		Privacy SW
		PV	NP		Without Privacy SW	With Privacy SW	
Calling	Dialing	<input type="radio"/>	<input type="radio"/>	Calls are made by touching dial. Even if the Privacy SW is on, calling is possible.	HF-650M	HF-660M HF-600M, 610M HF-620M, 630M HF-631M	ON/OFF
	One-Touch Dialing	<input type="radio"/>	<input type="radio"/>	Substations can make a call to designated Master Stations by one-touch dialing. Calling is possible even if the Privacy SW is on.	HF-640S	HF-600S HF-610S, 620S HF-630S, 631S	ON/OFF
	Dialing after picking up Handset and confirming Dial tone	<input checked="" type="radio"/>	<input type="radio"/>	Calls can be made by touching dial button after picking up handset, and confirming dial tone is heard.	TL-600M *2	HF-660M HF-600M HF-610M	ON
	Calling by picking up Handset	<input checked="" type="radio"/>	<input type="radio"/>	Substations can make a call to designated Master Stations just by picking up the handset.	TL-600S *2	HF-600S HF-610S	ON
Voice	Voice Calling	<input type="radio"/>	<input type="radio"/>	When called by continuous calling tone or privacy tone, voice can be sent by pressing (PTT) bar.	All stations except HF-640S		ON/OFF
Receiving	Hands-free Calling and Conversation	<input type="radio"/>	<input type="radio"/>	With touch-dial, after a brief calling tone Hands-free conversation is available.	HF-640S HF-650M	HF-660M HF-600M/S HF-610M/S 620M/S HF-630M/S 631M/S	OFF
	Continuous Calling Tone Response by One-Touch Dialing (No. 200 programming) *1	<input type="radio"/>	<input type="radio"/>	With touch-dial, a continuous calling tone is sent. Hands-free Conversation is available when called party depresses, the <input type="checkbox"/> ~ <input type="checkbox"/> , <input type="checkbox"/> or <input type="checkbox"/> key	HF-640S HF-650M	HF-660M HF-600M/S HF-610M/S 620M/S 630M/S 631M/S	OFF
	Privacy	<input type="radio"/>	<input checked="" type="radio"/>	When calls are unwanted, turn ON Privacy SW. Then, a brief privacy tone sounds when called. By turning off Privacy SW or touching any key (<input type="checkbox"/> ~ <input type="checkbox"/> , <input type="checkbox"/> , <input type="checkbox"/> key) or picking up a handset, conversation becomes available.	—	HF-660M HF-600M/S HF-610M/S HF-620M/S HF-630M/S HF-631M/S	ON
	Continuous Calling Tone.Picking up Response (in Privacy Mode)	<input checked="" type="radio"/>	<input type="radio"/>	When called by Continuous Calling Tone, conversation is possible by picking up handset.	TL-600M/S *2	HF-660M HF-600M/S HF-610M/S	ON
	Continuous Calling Tone-One-Touch Response (in Privacy Mode)	<input checked="" type="radio"/>	<input type="radio"/>	Calls can be made just by touching the <input type="checkbox"/> ~ <input type="checkbox"/> , <input type="checkbox"/> or <input type="checkbox"/> key. Without picking up handset when called by Continuous Calling Tone.	—	Same as "Privacy"	ON
Speech Methods	Voice Switch Conversation	<input type="radio"/>	<input type="radio"/>	Voice switch conversation is available automatically, when two parties speak in hands-free mode.	HF-640S HF-650M	HF-660M HF-600M/S 610M/S HF-620M/S HF-630M/S 631M/S	ON/OFF
	Simplex Conversation by Press-to-Talk key	<input type="radio"/>	<input type="radio"/>	One-way conversation is available by a party who presses (PTT) . Releasing the (PTT) bar will reverse the one-way conversation flow.	HF-640S HF-650M	HF-660M HF-600M/S HF-610M/S HF-620M/S HF-630M/S 631M/S	ON/OFF
	Full Duplex Conversation	<input type="radio"/>	<input type="radio"/>	Full duplex conversation is available when one or two parties are speaking using a handset.	TL-600M/S *2 HF-640S HF-650M	HF-660M HF-600M/S 610M/S HF-620M/S 630M/S HF-631M/S	ON/OFF

*1 This function may be employed for the industrial type of station (Model HF-650M) or in the "PV" type system that needs to be continuously called.

*2 All stations other than the TL-600M/S (Intended for exclusive use in NP type system) may be used in both the PV and NP type system.

Station operation

1) Handset Master Station

Model TL-600M

NP Type

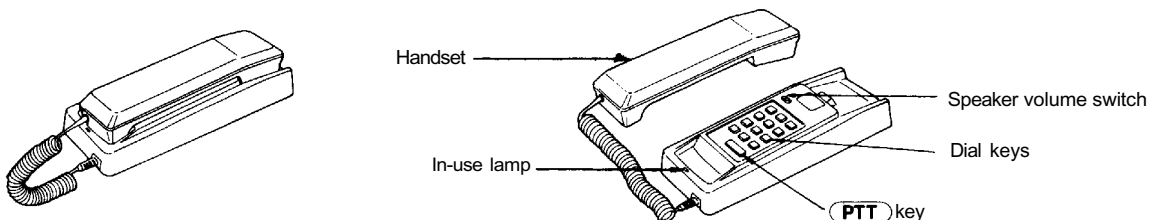

< Making a call >

1. Pick up the handset and touch dial the station number of the party you wish to talk to after hearing dial tone.
2. Start conversation after the calling tone stops.
3. When you hear a busy tone that indicates the party you call is on another line, you can camp on the line by simply waiting without hanging up the handset. As soon as the line becomes free, your call is automatically connected.
4. While the continuous calling tone is sent, you can break in on the calling tone by continuously depressing the **PTT** key to make a voice call through the station speaker of the called party.

5. Hang up the handset or depress the  key to terminate the conversation.

< Responding to a call >

6. When you are called by the continuous calling tone or paged through your station speaker, respond to the call by picking up the handset.

Note.

The sound volume of the calling tone may be adjusted by means of a 2-stage volume selector (SP. VOL) switch.

2) Handset Substation

Model TL-600S

NP Type

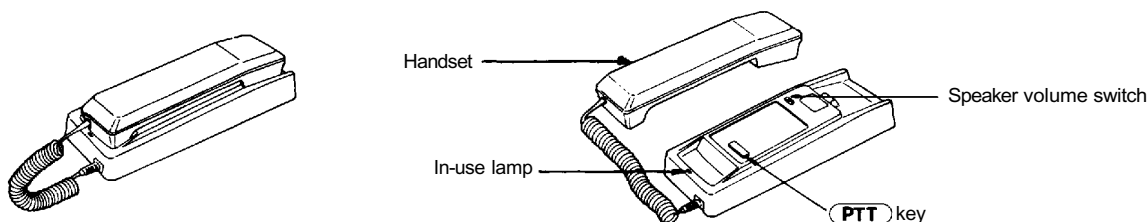

< Making a call >

1. Picking up the handset makes a call to the designated other station.
2. Start conversation after the calling tone stops.
3. When you hear a busy tone that indicates the party you call is on another line, you can camp on the line by simply waiting without hanging up the handset. As soon as the line becomes free, your call is automatically connected.
4. While the continuous calling tone is sent, you can break in on the calling tone by continuously depressing the **PTT** key to make a voice call through the station speaker of the called party.

5. Hang up the handset to terminate the conversation.

<Responding to a call>

6. When you are called by the continuous calling tone or paged through your station speaker, respond to the call by picking up the handset.

Note.

The sound volume of the calling tone may be adjusted by means of a 2-stage volume selector (SP. VOL) switch.

3) Hands-free Master Station

Model HF-620M/630M/631M/650M

PV Type

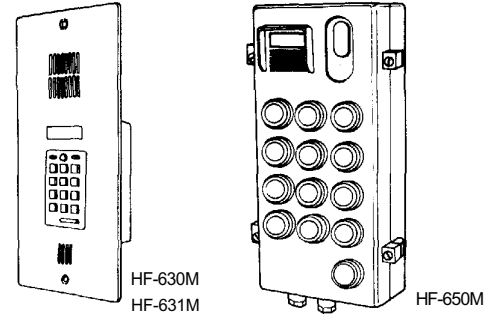
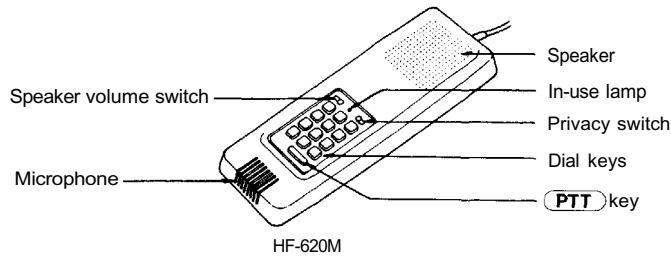

< Making a call >

1. Touch dial the station number you wish to call, regardless of whether the Privacy switch of your station is in the ON position or OFF position.
2. Start conversation after the calling tone stops.
3. When the line is busy, a busy tone is heard and you can camp on the line by simply waiting. As soon as the line becomes free, your call is automatically connected.
4. During a call attempt made by means of the continuous calling tone or the Privacy tone, you can break in on the calling tone by continuously depressing the **PTT** key to make a voice call through the station speaker of the called party.
5. When the party you call is in a high noise level area, your continuously depressing the **PTT** key allows one-way conversation to that party. As long as you depress the **PTT** key, your voice has dominance and releasing the **PTT** key will reverse the one-way conversation from that party to you.
6. To terminate the conversation, depress the **☐** key.

< Responding to a call >

- [In the case that the Privacy switch is in the OFF position.]
7. Respond to the call after the calling tone stops.
- [In the case that the Privacy switch is in the ON position.]
8. A brief Privacy tone sounds from your station each time there is an incoming call and all incoming calls are refused.
To respond touch dial any key (1~9, *, 0, ☐) other than the **PTT** key while the line is connected between you and the calling party.

Note.

1. The sound volume of the speaker may be adjusted by means of the 2-stage volume selector (VOL) switch.
2. With no speaker built inside, the HF-650M needs to be connected to a separate speaker. Also, the HF-650M is fitted with no Privacy switch.

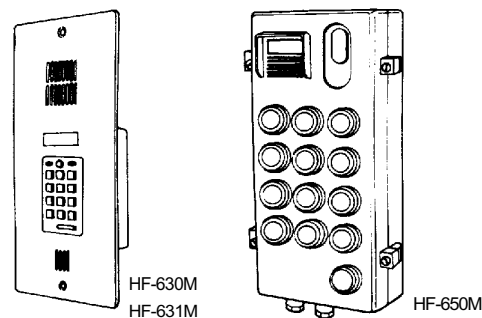
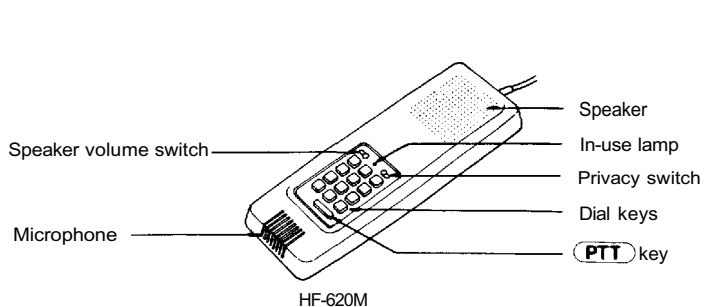

< Making a call >

1. Touch dial the station number you wish to call, regardless of whether the Privacy switch of your station is in the ON position or OFF position.
2. Start conversation after the calling tone stops.
3. When the line is busy, a busy tone is heard and you can camp on the line by simply waiting. As soon as the line becomes free, your call is automatically connected.
4. During a call attempt made by means of the continuous calling tone, you can break in on the calling tone by continuously depressing the **PTT** key to make a voice call through the station speaker of the called party.
5. When the party you call is in a high noise level area, your continuously depressing the **PTT** key allows one-way conversation to that party. As long as you depress the **PTT** key, your voice has dominance and releasing the **PTT** key will reverse the one-way conversation from that party to you.
6. To terminate the conversation, depress the **[C]** key.

< Responding to a call >

[In the case that the Privacy switch is in the OFF position.]

7. Respond to the call after the calling tone stops .

[In the case that the Privacy switch is in the ON position.]

8. The continuous calling tone function is made available to any station if its Privacy switch is placed in the ON position. Depressing any key (**[1]~[9]**, **[*]**, **[#]**) other than the **PTT** key causes the continuous calling tone to stop and puts the station in the conversation mode.

Note.

1. The sound volume of the speaker may be adjusted by means of the 2-stage volume selector (VOL) switch.
2. With no speaker built inside, the HF-650M needs to be connected to a separate speaker. Also, the HF-650M is fitted with no Privacy switch.

4) Hands-free Substation

Model (HF-620S/630S/631S/640S)

PV Type

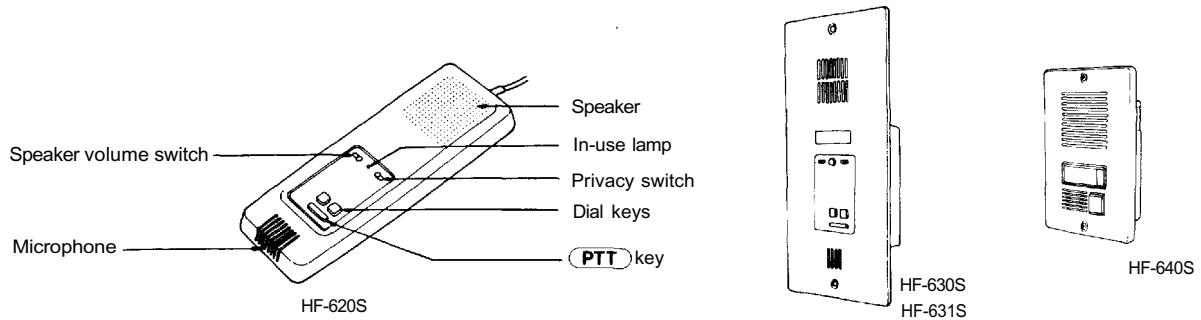

< Making a call >

1. Touching the key makes a call to the designated other station whether the Privacy switch on your station is in the ON position or OFF position.
2. Start conversation after the calling tone stops.
3. When the line is busy, a busy tone is heard and you can camp on the line by simply waiting. As soon as the line becomes free, your call is automatically connected.
4. During a call attempt made by means of the continuous calling tone or the Privacy tone, you can break in on the calling tone by continuously depressing the key to make a voice call through the station speaker of the called party.
5. When the party you call is in a high noise level area, your continuously depressing the key allows one-way conversation to that party. As long as you depress the key, your voice has dominance and releasing the key will reverse the one-way conversation from that party to you.
6. To terminate the conversation, depress the key.

< Responding to a call >

[In the case that the Privacy switch is in the OFF position.]

7. Respond to the call after the calling tone stops.

[In the case that the Privacy switch is in the ON position.]

8. A brief Privacy tone sounds from your station each time there is an incoming call, and all incoming calls are refused.
To respond, touch dial the or key while the line is connected between you and the calling party.

Note.

1. The sound volume of the speaker may be adjusted by means of the 2-stage volume selector (VOL) switch.
2. The HF-640S is fitted with no Privacy switch, nor key, nor key.





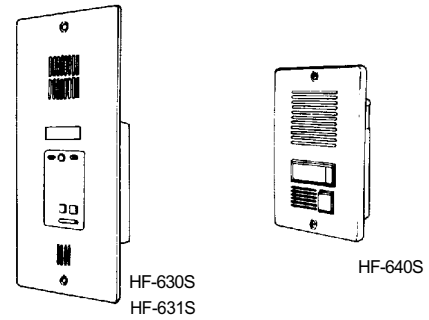
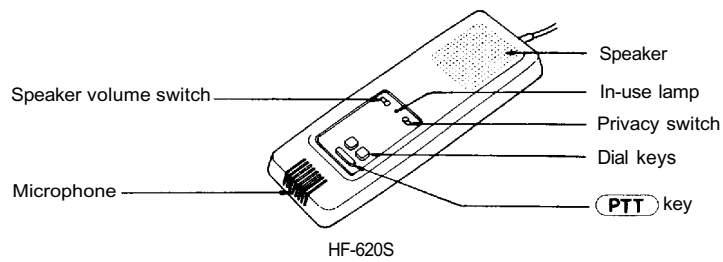

4) Hands-free Substation

Model (HF-620S/630S/631S/640S)

NP Type



< Making a call >



1. Touching the  key makes a call to the designated other station whether the Privacy switch on your station is in the ON position or OFF position.
2. Start conversation after the calling tone stops.
3. When the line is busy, a busy tone is heard and you can camp on the line by simply waiting. As soon as the line becomes free, your call is automatically connected.
4. During a call attempt made by means of the continuous calling tone, you can break in on the calling tone by continuously depressing the  key to make a voice call through the station speaker of the called party.
5. When the party you call is in a high noise level area, your continuously depressing the  key allows one-way conversation to that party. As long as you depress the  key, your voice has dominance and releasing the  key will reverse the one-way conversation from that party to you.
6. To terminate the conversation, depress the  key.

< Responding to a call >



[In the case that the Privacy switch is in the OFF position.]

7. Respond to the call after the calling tone stops.

[In the case that the Privacy switch is in the ON position.]

8. The continuous calling tone function is made available to any station when its Privacy switch is in the ON position. Depressing the  or  key makes the continuous calling tone stop and puts the station in the conversation mode.

Note.

1. The sound volume of the speaker may be adjusted by means of the 2-stage volume selector (VOL) switch.
2. The HF-640S is fitted with no Privacy switch, nor  key, nor  key.

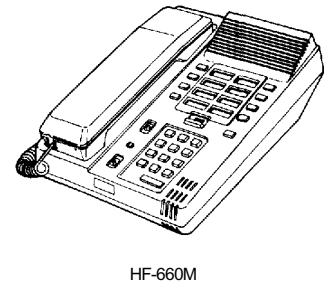
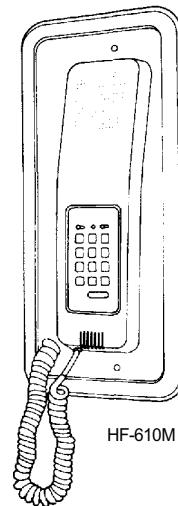
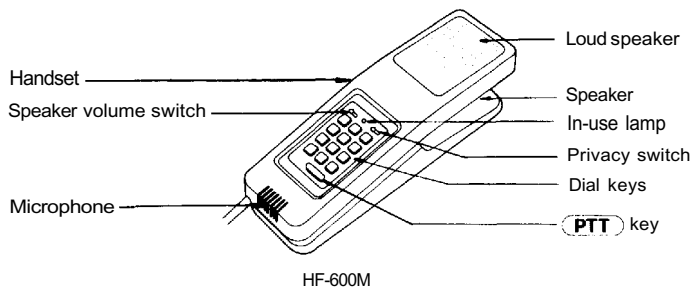

< Making a call >

1. Hands-free conversation may be made by simply touch dialing the station number you wish to call.
2. When you wish to use the handset, pick it up, then touch dial the station number you wish to call, or reverse the order.
3. Start conversation after the calling tone stops.
4. When you hear a busy tone that indicates the party you call is on another line, you can camp on the line by simply waiting. As soon as the line becomes free, your call is automatically connected.
5. In the event that the party you are calling does not respond and the continuous calling tone is still heard from your station, or when the station of that party is in the Privacy mode and the Privacy tone is sounded, you can break in on the calling tone by continuously depressing the **(PTT)** key to make a voice call through the station speaker of the called party.
6. During hands-free conversation, when the person you are talking to is in a high noise level area,
 - (1) Pick up the handset to talk or (2) depress the **(PTT)** key continuously for one-way conversation to that party. As long as the **(PTT)** key is depressed, your voice has dominance, and releasing the **(PTT)** key will reverse the one-way conversation from that party to you.
7. To terminate the conversation, hang up the handset or depress the **(☐)** key.

< Responding to a call >

[In the case that the Privacy switch is in the OFF position.]

8. Respond to call after the calling tone stops.

[In the case that the Privacy switch is in the ON position.]

9. A brief Privacy tone will sound from your station each time it receives an incoming call and all incoming calls are refused. To respond, depress any key (**[1 ~ 9]**, **[☐]**, **[*]**, **[#]**) other than the **(PTT)** key or pick up the handset while the line is still connected between your station and the calling station. These 2 busy stations are, however, automatically disconnected from the speech path after approximately 10 seconds from call establishment if no response is made by you.

Note.

The sound volume of the loud speaker may be adjusted by means of the 2-stage volume selector (VOL) switch.

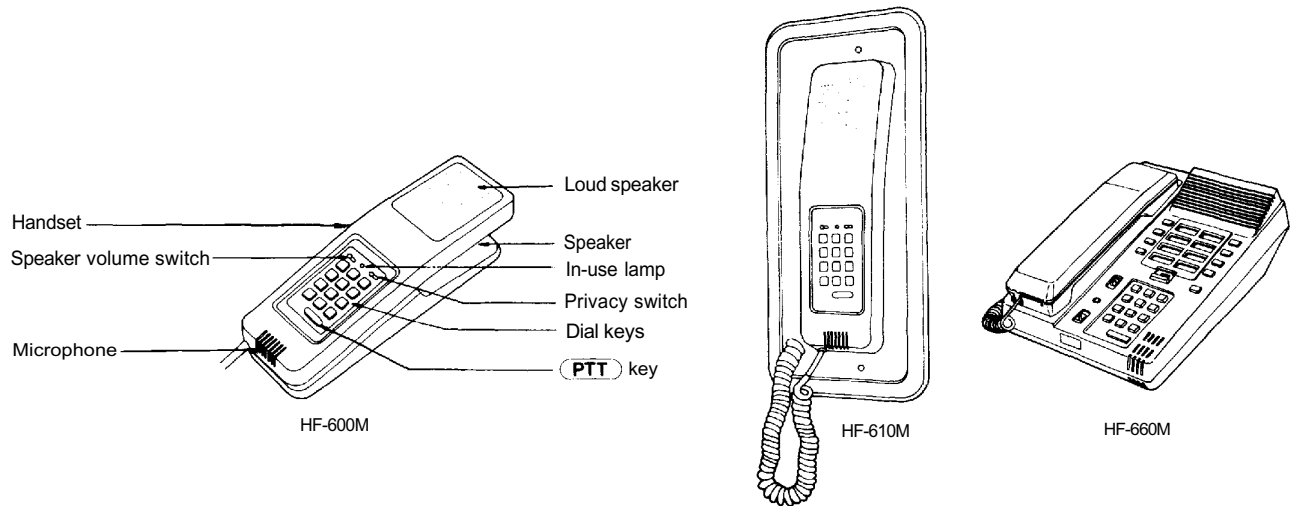

< Making a call >

1. Hands-free conversation may be made by simply touch dialing the station number you wish to call.
2. When you wish to use the handset, pick it up, then touch dial the station number you wish to call, or reverse the order.
3. Start conversation after the calling tone stops.
4. When you hear a busy tone that indicates the party you call is on another line, you can camp on the line by simply waiting. As soon as the line becomes free, your call is automatically connected.
5. In the event that the party you are calling does not respond and the continuous calling tone is still heard from your station, you can break in on the calling tone by continuously depressing the **PTT** key to make a voice call through the station speaker of the called party.
6. During hands-free conversation, when the person you are talking to is in a high noise level area,
 - (1) Pick up the handset to talk or (2) depress the **PTT** key continuously for one-way conversation to that party. As long as the **PTT** key is depressed, your voice has dominance, and releasing the **PTT** key will reverse the one-way conversation from that party to you.
7. To terminate the conversation, hang up the handset or depress the **☐** key.

< Responding to a call >

- [In the case that the Privacy switch is in the OFF position.]
8. Respond to call after the calling tone stops.
[In the case that the Privacy switch is in the ON position.]
 9. The continuous calling tone function is made available to any station when its Privacy switch is in the ON position. Depressing any key (**1~9** , **☐** , **☐** or **☐**) other than the **PTT** key or picking up the handset of the station called causes the continuous calling tone to stop and puts the station in the conversation mode.

Note.

The sound volume of the loud speaker may be adjusted by means of the 2-stage volume selector (VOL) switch.

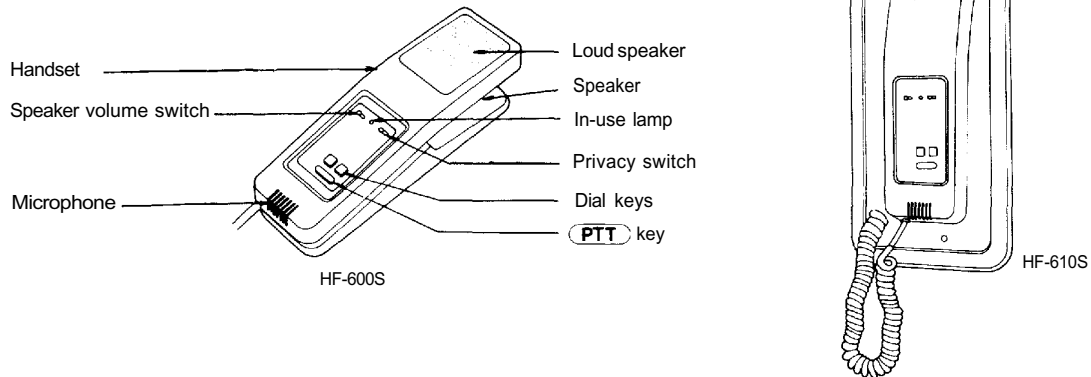

< Making a call >

1. For hands-free conversation, touching the key makes a call to the designated other station whether the Privacy switch on your station is in the ON position or OFF position.
2. When you wish to use the handset, pick it up, then touch dial the key to make a call or reverse the order.
3. Start conversation after the calling tone stops.
4. When you hear a busy tone that indicates the party you call is on another line, you can camp on the line by simply waiting. As soon as the line becomes free, your call is automatically connected.
5. In the event that the party you are calling does not respond and the continuous calling tone is still heard from your station, or when the station of that party is in the Privacy mode and the Privacy tone is sounded, you can break in on the calling tone by continuously depressing the key to make a voice call through the station speaker of the called party.
6. During hands-free conversation, when the person you are talking to is in a high noise level area,
 - (1) Pick up the handset to talk or (2) depress the key continuously for one-way conversation to that party. As long as the key is depressed, your voice has dominance, and releasing the key will reverse the one-way conversation from that party to you.
7. To terminate the conversation, hang up the handset or depress the key.

< Responding to a call >

- [In the case that the Privacy switch is in the OFF position.]
8. Respond to call after the calling tone stops.

[In the case that the Privacy switch is in the ON position.]
 9. A brief Privacy tone will sound from your station each time it receives an incoming call and all incoming calls are refused. To respond, depress the or key or pick-up the handset while the line is still connected between your station and the station calling. These 2 busy stations are, however, automatically disconnected from the speech path after approximately 10 seconds from call establishment if no response is made by you.

Note.

The sound volume of the loud speaker may be adjusted by means of the 2-stage volume selector (VOL) switch.

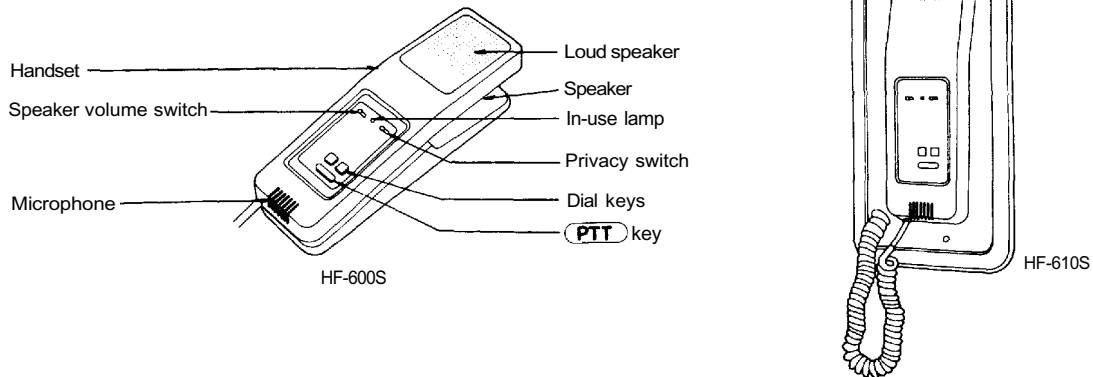

< Making a call >

1. For hands-free conversation, touching the key makes a call to the designated other station whether the Privacy switch on your station is in the ON position or OFF position.

[In the case that the Privacy switch is in the OFF position.]

2. When you wish to use the handset, pick it up, then touch dial the key to make a call or reverse the order.

[In the case that the Privacy switch is in the ON position.]

3. Picking up the handset makes a call to the designated other station.

-
4. Start conversation after the calling tone stops.
 5. When you hear a busy tone that indicates the party you call is on another line, you can camp on the line by simply waiting. As soon as the line becomes free, your call is automatically connected.
 6. In the event that the party you are calling does not respond and the continuous calling tone is still heard from your station, you can break in on the calling tone by continuously depressing the key to make a voice call through the station speaker of the called party.
 7. During hands-free conversation, when the person you are talking to is in a high noise level area,
 - (1) Pick up the handset to talk or (2) depress the key continuously for one-way conversation to that party. As long as the key is depressed, your voice has dominance, and releasing the key will reverse the one-way conversation from that party to you.
 8. To terminate the conversation, hang up the handset or depress the key.

< Responding to a call >

[In the case that the Privacy switch is in the OFF position.]

9. Respond to call after the calling tone stops.

[In the case that the Privacy switch is in the ON position.]

10. The continuous calling tone function is made available to any station when its Privacy switch is in the ON position. Depressing the or key or picking up the handset of the station called makes the continuous calling tone stop and puts the station in the conversation mode.

Note.

The sound volume of the loud speaker may be adjusted by means of the 2-stage volume selector (VOL) switch.

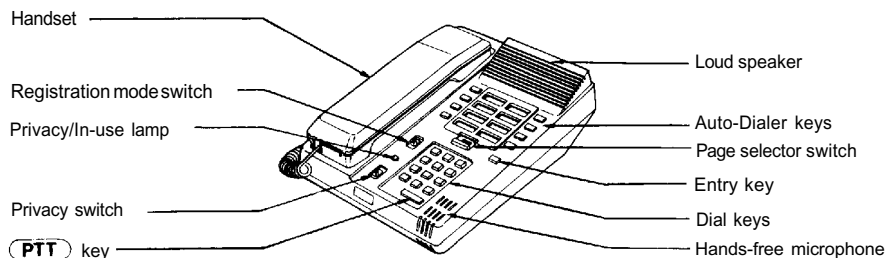

< Making a call >

1. Place the auto-dialer registration (REGISTER) switch in the OFF position.
2. A maximum of 16 single digit dialing numbers including station numbers, personal numbers and paging zone number may be programmed into the built-in auto-dialer.

(16 registrations are possible with 8 keys by changing over the Page selector switch)

You can not only call any station by touch dialing the station selector key but also you can make a call to up to 16 specific, pre-registered stations by depressing the station selector key or by single digit dialing the auto-dialer key of this station.

Expansion of another 24 auto-dialer keys is possible by connecting the **AK-024** auto-dialer key unit to the HF-660M.

Note.

1. For programming the auto-dialer, please refer to the operation manual of the HF-660M.
2. The sound volume of the calling tone can be adjusted by means of the 3-stage selector (SP VOL) switch.
3. For instructions on how to call and respond without using the auto-dialer, please refer to the information as to the HF-600M/610M.

<How to make Registration at Auto-Dialer>

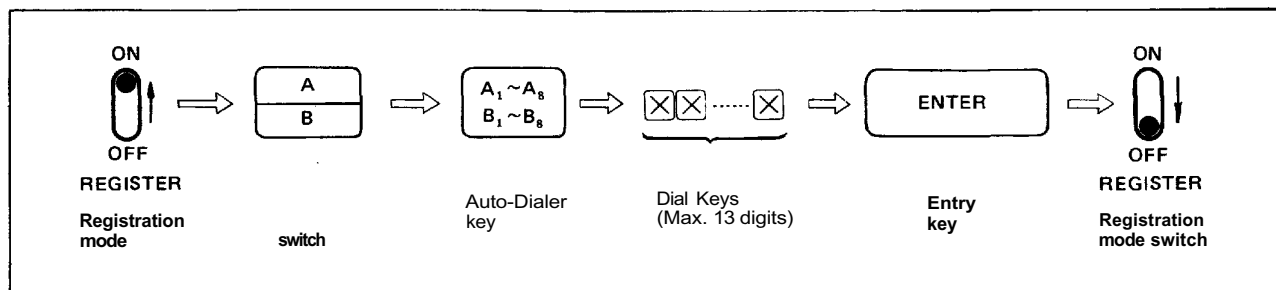

1. Place the registration mode switch (**REGISTER**) in the ON position.
A lamp turns to green and a confirmation tone is heard.
2. Place the page selector switch in either **A** or **B** position.
3. Press any one of the auto-dialer keys (**A₁~A₈**, **B₁~B₈**), which is to be registered.
4. Register the station or other numbers to be registered by pressing the dial keys (**1~9**, **0**, *****, **#**) A maximum of 13 digits on each auto-dialer key may be registered
5. Press the entry key (**ENTER**). The confirmation tone is again heard and registration is completed.
6. Repeat the procedures described in (2) through (5) each time registration is made.
7. To cancel the registration, press the auto-dialer key (**A₁~A₈**, **B₁~B₈**) and the Entry Key (**ENTER**).
8. Place the registration mode switch (**REGISTER**) in the OFF position. The lamp goes out and the normal speech mode will resume.

Functions: EXES-6000 CP-64

No.	Classification	Function	Standard Function	Selectable Function		Optional Function	Single Exchange	Tie-line		
				By DIP Switch	By No. 200 Programming			Own Exchange	Outside Exchange	
1		Automatic Line Release	○				○	○	○	
2		Camp-On-Busy	○				○	○	○	
3		Mic-Off					○	X	X	
4		Single Digit Dialing	○				○	○	○	
5	Single Digit	Automatic Access to Paging			○		○	○	○	
6		Master/Sub Relationship			○		○	○	X	
7	Continuous Calling Tone	Privacy • Camp-On-Privacy/Continuous Calling Tone at Privacy Mode *1		○			○	○	○	
8		Continuous Calling Tone • One-touch Response *2		○	○		○	○	○	
9	PTT	Press-To-Talk	○				○	○	○	
10		Press-To-Talk Control		○*3		○	○	X	X	
11	Personal Number	Personal Number Call			○*4		○	○	○	
12		Personal Number Paging		○		○	○	X	X	
13		Remote Response	○				○	○	X	
14		Call Transfer • Paging during Normal call		○		(○)*5	○	○	X	
15	Transfer	Group Hunting		○	○		○	○	X	
16		Secretary Transfer		○	○		○	○	X	
17		Call Forwarding		○			○	X	X	
18	Priority	Priority		○			○	X	X	
19		Executive Priority		○	○		○*6	X	X	
20		Highest Executive Priority		○	○		○*6	○	○	
21	Conference	Conference		○		○	○	○	○	
22	Paging and Response	PA Paging • Station Paging All-Call +31 zones (Single Exchange)/30 zones (2 Exchanges)/ 45 zones (3 Exchanges) *7		○	(○)*5	○	○	○	○	
23		Combination Paging		○	○	○	○	X	X	
24		Emergency All-Call		○		○	○	X	X	
25		Paging Priority		○	○	○	○	X	X	
26	Selection of Dial Operation	Selectable First Station Number of Each Exchange No. 100/200/300/400/500/600/700/800/900		○	○		○	○	○	
27		Output Capacity of Paging Zone		○			○	-	-	
28		Selectable Dial Operation for Paging Response		○			○	○	○*9	
29		Output Capacity of General Purpose Control		○			○	○	X	
30		Programmable Station Numbering		○	○		○	○	○*10	
31		Group Blocking (Restricted Dialing)		○	○		○	○	○	
32	Restricted Access	Restricted Access to All-Call Paging					○	○	○	
		Restricted Access to Conference					○	○	○	
		Restricted Access to General Purpose Control	One-shot make output							
			Make/break output		○					
			8 selectable one-shot make output 8 selectable make output/Decimal output		○			○	○	X
4 decimal digits output		○								
33	Selection	Calling Tone • Paging Pre-Announcement Tone Duration *11			○		○	○	○	
34		Time out of Conversation and Paging Call			○		○	○	○	
35	Interface	IN/OUT Annunciation			○*4		○	○	○	
36		Destination Annunciation Indication				○	○	X	X	
37		Calling Party Indication (Lamp type) (with/without memory)		○*12	○		○	○	X	
38		Calling Party Indication (Numerical type)					○	X	X	
39		Pager (make output type)		○		○	○	○	○*13	
40	General Purpose Control	One-shot make output								
		Make/break output								
		8 selectable one-shot make output		○			○	○	X	
		8 selectable make output/Decimal output								
		4 decimal digits output								

Functions: EXES-6000 CP-64

Notes.

1. XX/YY indicates to select either XX (Function) or YY (Function).
2. Not all circles (○) in The Switch Selection table correspond to the DIP switches of the CP unit.
- *1: "PV" (system with Privacy function) Type: with the Privacy switch in the ON position, a brief Privacy Tone sounds.
"NP" (system without Privacy function) Type: A station may be called by the continuous calling tone when the Privacy switch is placed in the ON position.
- *2: When a hands-free station without handset is called by the continuous calling tone, conversation may start by touching any key (☐~☐, ☐ or ☐).
- *3: Using the Press-to-talk control function reduces the maximum number of paging zone to All call + 23 zones.
- *4: This function may not be used if numbers 100 through 199 are used in the Station Numbering Schedule. Either "Personal number call" or "Personal number paging" may be selected.
- *5: Additional equipment is required for paging.
- *6: Either "Executive Priority" or "Highest Executive Priority" may be selected.
- *7: Each zone of paging provides Station paging and/or PA paging.
- *8: It is necessary to respond only by touching ☐ ☐ (without zone No.).
- *9: It is possible to make a paging and its response across the other exchange. However, a response to the zone paging is possible only from a station connected to the exchange having the paged zone.
- *10: Station numbers of each exchange can be changed freely within the range of "Selectable numbering schedule of each exchange".
- *11: Calling tone: 0.3 sec (Trill note tone)/0.2 sec (Single note tone)/none.
Paging pre-announcement tone: 2 sec/1 sec/none.
- *12: Selects whether or not the indication of the calling party station continuously lights up, after the calling party has cancelled the call to a line which is busy or in the privacy mode.
- *13: A call can only be made from the stations No. 200 ~ 455 connected to the "A" type exchange. It is possible to respond from any station.

Chapter 2

Functions and operating procedures
of single exchange system for
a maximum of 256 stations

Part names and functions of the station keyboard

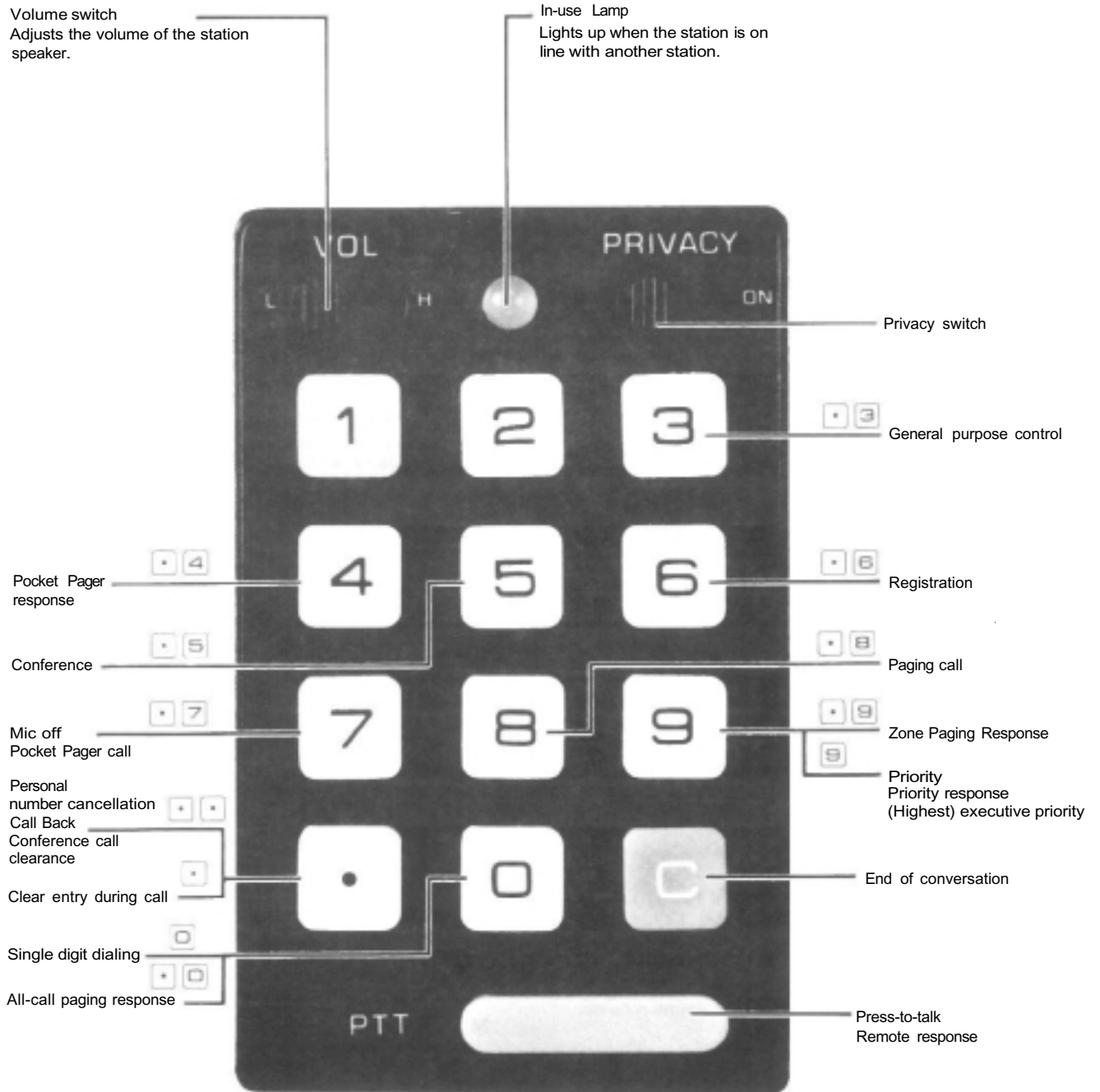

Function description



Besides fixed standard functions, there are selectable standard functions and optional functions. Selectable standard functions can be selected by changing over The CP Unit switches and by establishing station No. 200 programming. Optional functions can be made available by using external equipment or additional units.

1. Standard Functions

- 1) Automatic Line Release
The calling Station is released from the speech path if dialing is not completed within 5 seconds. The called station is also released from the speech path if no response is given within 10 seconds, when calling a station in the privacy mode.
- 2) Camp-on-Busy
When the called party is busy, the caller can camp-on the line. After the conversation is finished, he is automatically put through.
- 3) Press-to-Talk
One-way conversation is possible by pressing the Press-to-Talk bar when the ambient noise is high at one party's station.
- 4) Mic-off
Line is held temporarily.
- 5) Remote Response
The station called by continuous calling tone can be remotely answered by other stations.
- 6) Single Digit Dialing
Single digit calling of numbers up to 4 digits in length can be made by one-touch operation.

2. Selectable Functions

- 7) Master/Sub Relationship
Substations can call Master stations by one-touch operation. In the event of Handset Substation, a call can be made from Substation to its designated master station by simply picking up a handset.
- 8) Automatic Access to Paging
Specific Substations may initiate a Paging Call or Paging Response or Personal Number Call, etc. by simply picking up a handset.
- 9) Privacy
When calls are unwanted, turn Privacy switch on and a brief privacy tone sounds when the station is called.
- 10) Camp-on-Privacy
When called in the privacy mode from another station, calls can be connected immediately after releasing the Privacy switch.
- 11) Handset Response in Continuously Called Stations
Full duplex handset conversation is available by lifting the handset when the continuous calling tone is heard.
- 12) One-touch Response in Continuously Called Stations
Hands-free conversation is available by just touching any key except **(PTT)** when the continuous calling tone is heard.
- 13) Personal Number Call
Calls can be connected by using Personal Numbers, other than normal station numbers when Personal Numbers are registered into any designated station.

- 14) Call Transfer
The called party can transfer the call to other selected station. Call Hold and Call Back are also possible.
- 15) Group Hunting
When the first called party in a group is busy, the call is automatically transferred to the next stations.
- 16) Secretary Transfer
Calls to an "Executive" may be automatically transferred to a "Secretary".
- 17) Call Forwarding
Calls to stations are automatically transferred to any other designated station.
- 18) Priority
When the party called is busy, by just sending priority tone conversation is available if response is given, holding the original conversation.
- 19) Executive Priority
When the party called is busy, the caller can break in on the called party without the response, holding the original conversation.
- 20) Highest Executive Priority
The preprogrammed caller can interrupt forcibly the called party in busy mode. In this event, original conversation is cancelled.
- 21) Selection of Dial Operation
 - ① Selectable First Station Number
The first station number for system may be selected from any of the following numbers (Hardwired station number): 100/200/300/400/500/600/700/800/900.
The system with Personal Numbers can't use No. 100 ~ 199.
 - ② Paging Response
Paging response may be made either by pressing the "Zone No.", or [Simply pressing  ].
 - ③ General Purpose Control
Dial digit numbers change the output numbers.
- 22) Programmable Station Numbering
The system has programmable station numbers up to No. 999 rather than only the normal hardwired station numbers.
- 23) Group Blocking (Restricted Dialing)
Stations can be blocked into groups which cannot call or page each other unless further programming is done.
- 24) Restricted Access
Stations with access to All-call Paging, Conference and General Purpose Control can be limited.
- 25) Selectable Calling Tone
(Calling Tone/Paging Pre-Announcement Tone)
The time duration of the Calling Tone can be set for "long" (Trill note tone) or "short" (Single note tone) or none. Similarly, Paging Pre-Announcement Tone may be set for "long" (2 sec.) or "short" (1 sec.) or none.
- 26) Time-out of Conversation and Paging Call
A Calling Time Limitation can be set, in case paging and normal calls are to be kept short or where cancelling calls might be forgotten.

3. Optional Functions

- 27) Station Paging and Response (PI-62 Unit is required)
Paging is available through the built-in station speakers. Paging calls can be responded to by the nearest master station.
- 28) Paging Priority and Response (PI-62 Unit is required)
Conversation may be interrupted temporarily to accept the priority station paging.
- 29) Combination Paging and Response (PI-62 Unit is required)
Combination paging zones which cover 2 or more independent paging zones is allowed in the system.
- 30) Paging during Normal Call
Calls can be transferred to a third party after paging while speaking.
- 31) Personal Number Paging
Zone paging is made by Personal Numbers when Personal Numbers are registered into any designated station within a zone.
- 32) PA Paging and Response (PI-62 Unit and PA System are required)
Paging through PA System and response.
- 33) Emergency All-Call Paging (PI-62 Unit is required)
Top priority of all-call paging is available from one specified station.
- 34) Conference (CL-62 Unit is required)
Conference calls can be made including up to 4 persons.
- 35) Press-to-Talk Control (PI-62 is required)
The operation of Press-to-Talk activates Relay Outputs, thus controlling Door-Lock and Radio Transmitting Equipment.
- 36) In/Out Annunciation
(Interface for the Indicator Board needs to be made by using Data Transmitter DT E11 and Receiver DR-B61)
In or Out status is annunciated by registration/cancellation of Personal Numbers.
- 37) Destination Annunciation Indication
(Interface for the Indicator Board is to be made by using Data Transmitter DT-E11 and Receiver DR-B61.)
Personal number registered stations are indicated.
- 38) Calling Party Indication [Lamp Type]
(Interface for the Indicator Board is made by using Data Transmitter DT-E11 and Receiver DR-B61.)
One lamp for one calling station. This can memorize the station numbers of stations which put through calls to stations in the privacy or busy modes.
- 39) Calling Party Indication [7-SEG Display Type]
(Interface for the Indicator Board is made by using Data Transmitter DT-E11 and Receiver DR-B61.)
A numerical type calling party indication panel can be provided at certain specified stations.
- 40) Pager Calling and Response
(Interface is accomplished by using Data Transmitter DT-E11 and Receiver DR-B61)
Pagers with relay input interface can be connected.
- 41) General Purpose Control
(Make the Indicator Board and General Purpose Control Interface by using Data Transmitter DT-E11 and Receiver DR-B61)
Various types of Relay Output modes for control are available. Use as Remote Control for such applications as In/Out Annunciation, Destination Annunciation Indication, VTR and ITV.
- 42) Simplified Paging
Simplified PA paging is possible if an external speaker is connected instead of a station.

EXES-6000, CP-64 Summary of Dial Operations (For single exchange system)

Classification	Function	Dial operation	Number	Description
Call	Press-to-talk	Simplex Duplex		Conversation is simplex when PTT bar is used.
	Remote response			When a station is called by continuous calling tone, near station in the groups can respond the call instead of the called station.
	Remote response registration	Confirmation tone	X X X : Station No.	Group registration of stations can be made from each station.
	Continuous calling tone response	~ or		Called party touches one of these keys then conversation may begin.
	Privacy	PRIVACY ON Privacy off ON		When a party does not wish to accept incoming calls, set the Privacy Switch in the ON position.
	Secretary transfer	PRIVACY ON Secretary transfer off ON		This function allows for automatic transfer of calls to a secretary when desired.
	Single digit registration	(PTT button) Registration dials (maximum 4 digits)		This function allows for single digit registration of up to 4 digits among the numbers 0 through 9 and the key.
	Single digit dialing			Registered dial code may be automatically dialed.
	Personal number registration In/Out annunciation-lamp ON	Confirmation tone	1 X X X : 1000 ~ 1999	Personal number may be registered at any master station which the person to whom the number is assigned expects to be.
	Personal number cancellation In/Out annunciation-lamp OFF	Confirmation tone		When anyone having a personal number leaves the office he merely cancels the programming of his personal number.
	Personal number call Personal number paging			A personal number dialing enables the station call or zone paging for a person having the personal number.
	Conference	Calling Calling	X X X : Station No., Personal No., Single digit number	A conference call may be made with up to 4 persons. Participants must be called individually.
	Conference clear			If a person called into a conference is absent, the conference may be returned to the original condition.
	Call forwarding registration	Confirmation tone	X X X : Transferred Station No.	This function allows for automatic transfer of call to another station which number is registered already.
	Mic off			This function is used to temporarily hold a conversation, causing a holding tone to sound at both stations. The line is thus kept open until the party who operates the mic off switch re-dials and the call is continued.
	Priority/priority response	Busy tone ⇒ Station called	X X X : Station No., Personal No., Single digit number	When the called party is busy, this function signals to request priority. The party requesting can talk after the called party responds.
	Executive priority/ Highest executive priority	Busy tone		When the called party is busy, this function allows interruption of the existing conversation and immediate direct contact with the called party.
	Call transfer	Call conversation ⇄ Transfer ⇄ Conversation with original station		The called party can transfer the call to a selected other station (by station number, personal number or single digit number).

Classification	Function	Dial operation	Number	Description
Paging	All-call plus 9-zone paging	• 8 X	X : 0 (All-call), 1 ~ 8(9) (Zone) (9 : When combination paging is not used)	Any station can be used to initiate PA or station paging. A person paged can respond from the nearest master station.
	All-call plus 31-zone paging	• 8 X X	X X : 00 (All-call), 01 ~ 31 (Zone)	
	Combination paging	• 8 9 X	X : 0 ~ 9 (Combination)	Several zones may be paged simultaneously.
	All-call response	• 0 or • 8 (0) 0		Response to all-call
	Zone paging response	• 9 or • 9 (X) X	X : 1 ~ 9, X X : 01~31 90~99	Response to zone paging or combination paging.
	Paging transfer	Conversation • 8 X Paging C Transfer Conversation after response ⇒ • • Conversation with original station	X : 0-8(9) (00-31) 90-99	This function allows a called party to transfer the call to a third party who responds to paging.
Display and Control (Data Transmitting and Receiving Unit)	One-shot make output	• 3 (X) X X	X X X : 000 ~ 499 X X : 00-49	One-shot make output of relay may control other equipments such as ITV camera, VTR control, dictating systems, etc.
	Make/break output	• 3 5 (X) X X (Make) • 3 6 (X) X X (Break)	X X X : 000-511 X X : 00-99	Make/break output of relay may control other equipments.
	8-selectable one-shot make output	• 3 7 X Y Unit No. Condition No.	X : 1 ~ 9 Y : 1 ~ 8	8-selectable one-shot make is available (VTR control)
	8-selectable output (Decimal output)	• 3 8 (X) X Y Unit No. Condition No.	X : 1 ~ 9 Y : 1 ~ 8, 0 (Clear) X X : 01 ~ 64 (0-9) (01 ~ 99)	8 selectable outputs or a decimal output is available (indicating room status and destination).
	4 decimal digits output	• 3 9 X Y Y Y Y Unit No. 4-digits	X : 1 ~ 9 Y Y Y Y : 0000 ~ 9999	4 decimal digits output is indicated.
	Make output for Pager control	• 7 X X	X X : 00 ~ 99	Control the pocket pager by make output of relays.
	Pocket Pager response	• 4 X X		
	Calling party selection	• 9 X X X	X X X : Station No.	When the indication panel shows several incoming calls at the same, the called party may select any of them for response.
	Clearing calling party indication	C C		This is used to cancel the calling party indication without conversation.

Automatic Line Release

When, in dialing, all of the numbers are not dialed within 5 seconds, the station is automatically disconnected from the speech path and dialing cannot be completed. In this instance, the dialing process will have to be repeated from the beginning.

This function has been adopted to speed up traffic processing and to improve the availability of speech path.

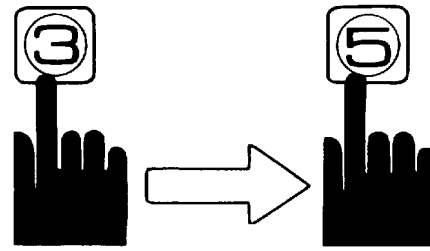

Within 5 sec

Camp-On-Busy

When the party you are calling is on another line, by simply waiting you automatically "Camp-On" the line. (Busy tone sounds continuously.) As soon as the line is freed, you will be automatically connected.

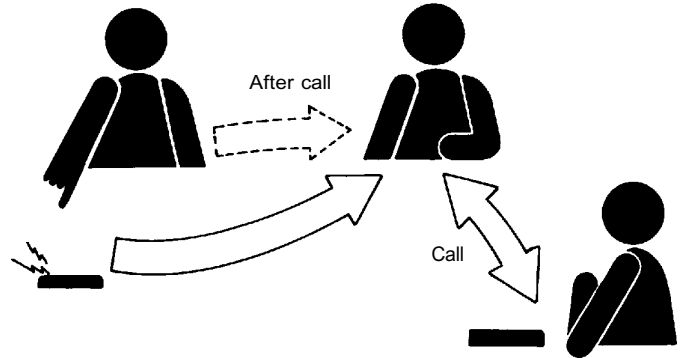

Privacy

PV Type

Shift Privacy Switch to ON.



When a party does not wish to accept incoming calls, this function may be employed to refuse them. With the Privacy switch in the ON position, a continuous privacy tone will be sounded in the station making the call, and at the same time, a brief Privacy tone will sound in the station called, indicating a call attempt is being made.

It is possible to call the other party from the station in the Privacy mode but Remote Response (PTT) is impossible from that station.

Shift Privacy Switch back to the left.



To restore a station in the "Privacy" mode to a normal condition, and thus ready to receive calls.

- Note:
1. A call received while the station is in the Privacy mode may be accepted if the Privacy function is immediately cancelled. (see Camp-On Privacy)
 2. With a station that incorporates the Secretary Transfer function, the Privacy switch is used to activate the Secretary Transfer function, (see Secretary Transfer)
 3. During the above "Privacy" mode, while the calling station has the PTT bar depressed, the privacy tone stops and the caller can transmit a one way message.

When the PTT bar is released, the normal "Privacy" mode to be resumed.

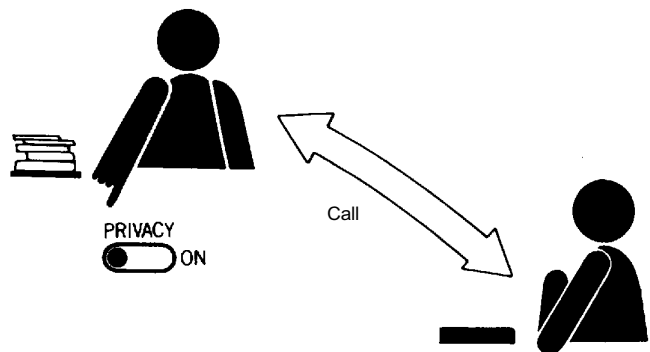
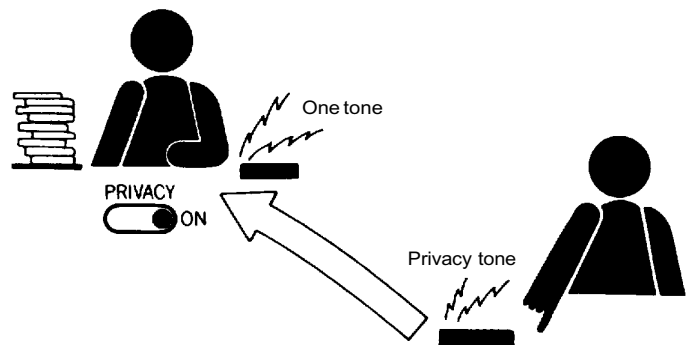

When the party you are calling has his station on Privacy mode, by simply waiting you will automatically "Camp-On" the line. (Privacy tone sounds continuously.) As soon as the Privacy mode is released, or as soon as he one-touch dials any of the keys (1~9, *, #, C), or as soon as he picks up a handset of his station, you will be automatically connected.

This function is cancelled automatically if the station in the privacy mode may not accept the call within approximately 10 seconds.

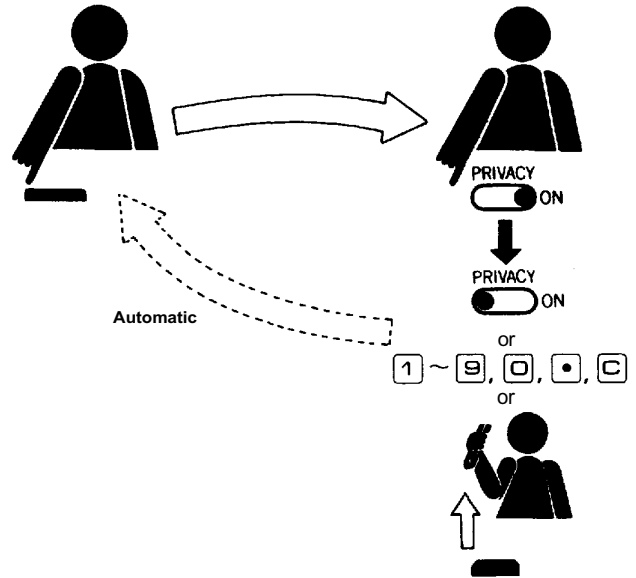

Press-To-Talk

This function is activated when the PTT  (Press-To-Talk Bar)

is continuously depressed after dial tone confirmation or during hands-free conversation. This allows one-way conversation from the party depressing the function key. When the key is released, one-way conversation is reversed.

Employed when a person in a high noise level area is called by a person in a quiet area, or when no particular response is required, or when simple announcements are made. In such cases, one-way conversation flow can be used.

One-way conversation is activated while the Press-To-Talk bar is continuously depressed.

As long as the Press-To-Talk bar is depressed by either party, the voice of the party using this function has dominance. When the key is released, the other party has dominance.

One-way conversation is reversed when the Press-To-Talk bar is released.

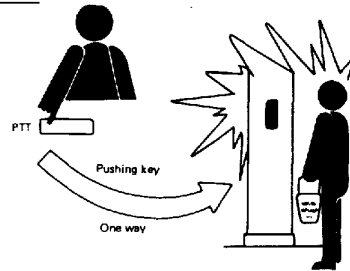

If both parties depress the Press-To-Talk bar, the voice of the party who depresses the bar last will have dominance.

Depress the



to return to ordinary hands-free 2-way conversation

Note.

One-way conversation is impossible even if the PTT  bar is depressed as far as either party or both parties involved pick up a handset.

Mic Off

Touch dialing of



during a conversation turns off that station's microphone, and a holding tone is heard at both stations involved.

This function is used when for one reason or another it is desirable to stop a conversation temporarily. With this function in use, a holding tone is transmitted to both the calling and the called station while the conversation is interrupted.

Touch dialing



again cancels the Mic-Off function, and the conversation can be resumed.

When it is desirable to resume the conversation interrupted with the Mic-Off function, the function may be cancelled by the Party who operates the Mic-Off.

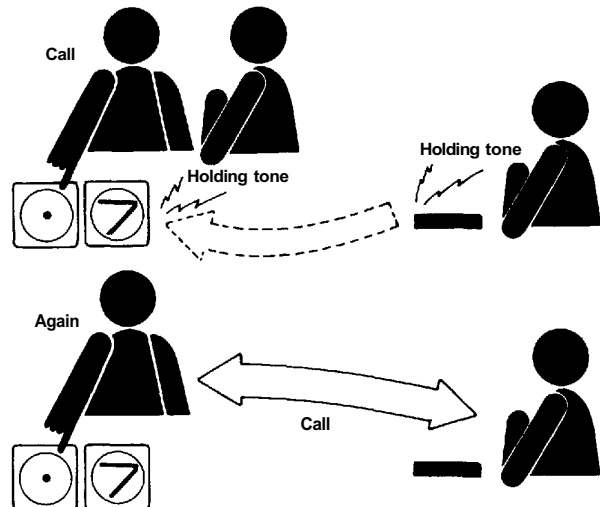

Press-To-Talk Control

Touch dialing the specific station number.

One way conversation is activated while the Press-To-Talk bar is continuously depressed, same as the Press-To-Talk (selected simplex) function, and a relay is activated with continuous make-contact.

One way conversation is reversed when the Press-To-Talk bar is released, and the relay is activated with break-contact.

Note.

1. Stations No.232 through No.239 (8 stations) are the specific stations.
2. It is possible to use a relay make output for Door Remote or for controlling Radio Transmitting/Receiving Equipment through user provided interface.
3. The relay output of the Paging Interface Unit PI-62 is used for this purpose.
Adaption of this function permits the paging of only all-call plus 23 zones (the paging of all-call + 31 zones is impossible.)

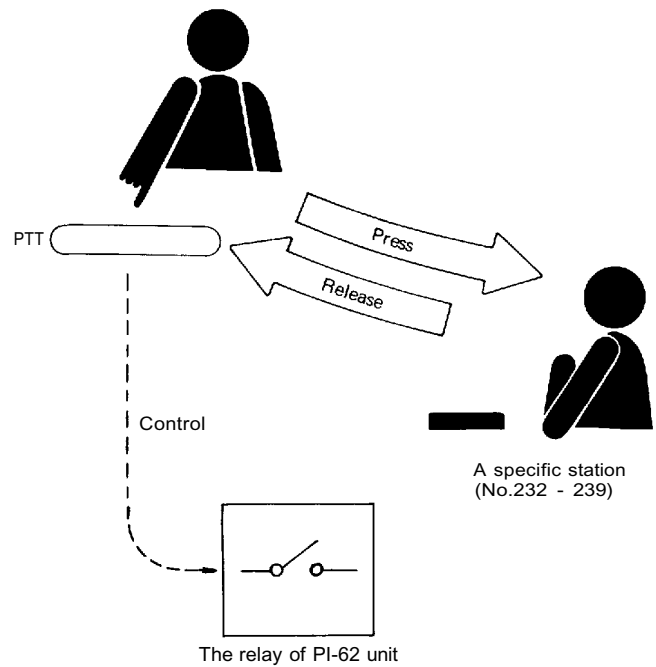

Single Digit Dialing

Single digit registration

Register in advance as follows:

• 6 0 X X X X	Confirmation tone	Single digits of station number
Station number		
• 6 0 1 X X X X	Confirmation tone	Single digit of personal number
Personal number		
• 6 0 • 8 X X X	Confirmation tone	Single digit of paging call
Paging zone		
• 6 0 • 0	Confirmation tone	Single digit of All-call paging response
• 6 0 X X X X X	Confirmation tone	
Any four digits		
• 6 0 X X X X	PTT Confirmation tone	
Any three digits		
• 6 0 X X X	PTT Confirmation tone	
Any two digits		

Single digit dialing

When required, dial



and the registered number will be called automatically.

Note:1. Single digit registration can be cancelled by registering your assigned station number.

2. Any function dialing with long operation may be shortened by Single Digit Dialing.

Example: Single digit Combination paging Dial

0 1 and • 8 0 1 is called automatically.

• 8 0 1 Combination paging

|| Single digit



3. One-shot make output may be operated even in the event every link is not free. But it may not be operated in single digit dialing if all links are busy.

4. Single digit registration is not available from any substation programmed by No.200 programming, even if its line is connected with master station.

Master Sub Relationship

Master/Substation associations are set up by using station #200 as the programming station. Once these relationships have been established, substations can then contact their designated master stations by simply touch dialing



If TL-600S Handset substation is used, substations can be connected to their designated master stations by simply picking up a handset. (Only applicable to NP Type system)

With respect to this function, the stations in the system are divided into two categories; master stations and substations. Any master station can be connected to any other station in the system. However, substations can initiate calls only to specific master stations. This is done by single touch dialing, and will only connect the substation to one specific master.

Several substations can be programmed under this station to connect with a single specified master station.

To register single digit dialing, touch dial



substation number

Single digit dialing from that master to a specific substation is then accomplished by touch dialing



Programming a master station for Single Digit Dialing of a substation number under this function is programmed in the same manner as other single digit dialing, and results in one touch dialing from master to substation.

Note.

Single digit registration is not available from any substation programmed by No.200 programming, even if its line is connected with master station.

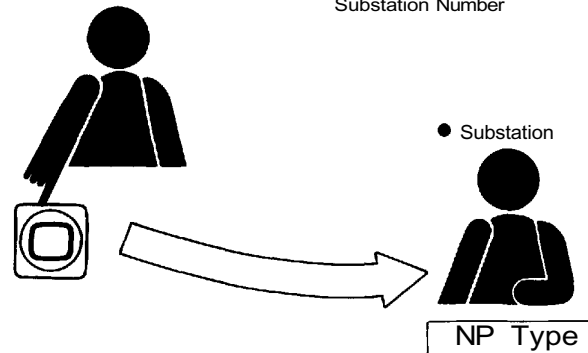
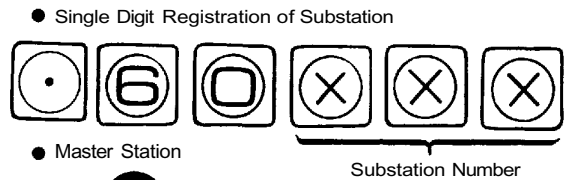
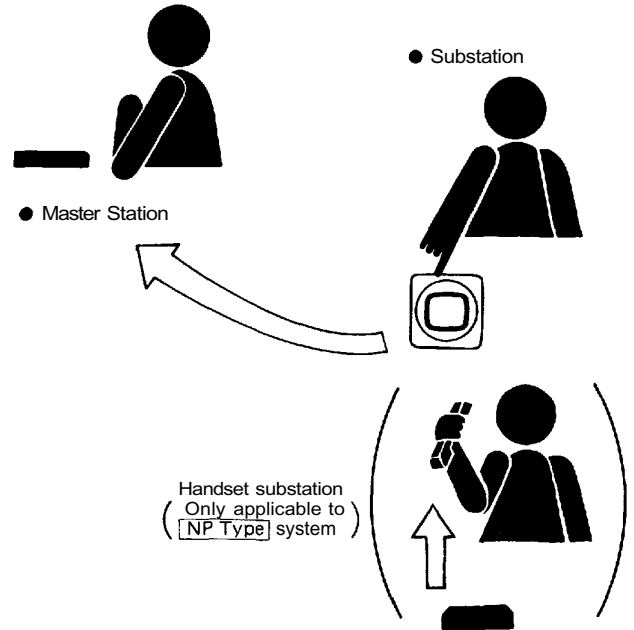

Automatic Access To Paging

Once programming has been set up for the purpose of this function.

A paging call may be made from specific Handset Substations to the registered zone by simply picking up a handset. Refer to Fig. 1

A specific Handset substations may respond to the paging call by simply picking up a handset. Refer to Fig. 2

Note.

Single digit registration for Handset Substation as well as No.200 programming is required for this function at the time of installation.

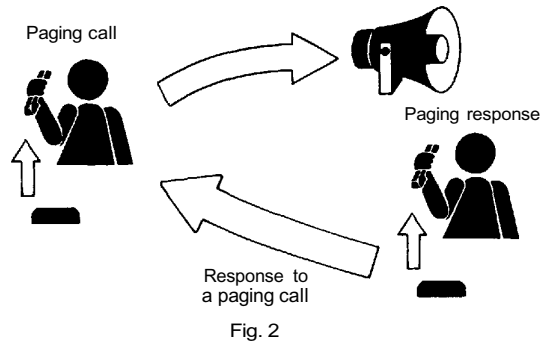
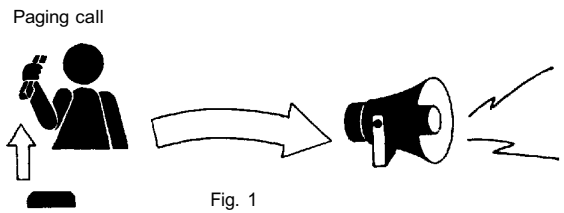

Personal Number Call

A personal number may be registered at any master station which the person to whom the number is assigned expects to be. A party wishing to receive personal number calls at a specific station may register his number at that station by touch dialing

• 6 1 X X X

Personal Number.

Those who are frequently away from their assigned station, as well as those who share a single station may be assigned a "Personal" 4-digit number which may be programmed to any master station in the system. This personal number, which is completely independent of station numbers, may be programmed at any master station, and any previous programming of that same number at any other station is automatically cancelled. When the party calling has dialed the number to which he wishes to speak, the call is then routed to the station at which the Personal Number was last registered. The numbers which may be assigned in this group are 1000 through 1999.

Personal number program cancellation can be done at any station by merely dialing:

• • 1 X X X

Personal Number

When anyone having a personal number leaves the office, he merely cancels the programming of his personal number. With the personal number cancelled, any incoming calls to that number will be answered by a dial tone, indicating that he is not available.

Note.

The maximum number of the Personal Number remains same even if the number of exchange to be connected is increased to 2 or 3.

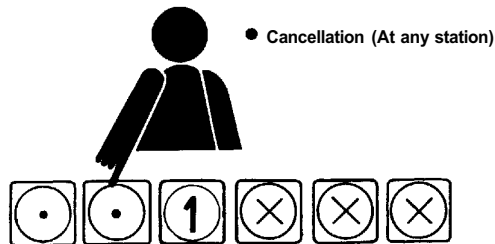
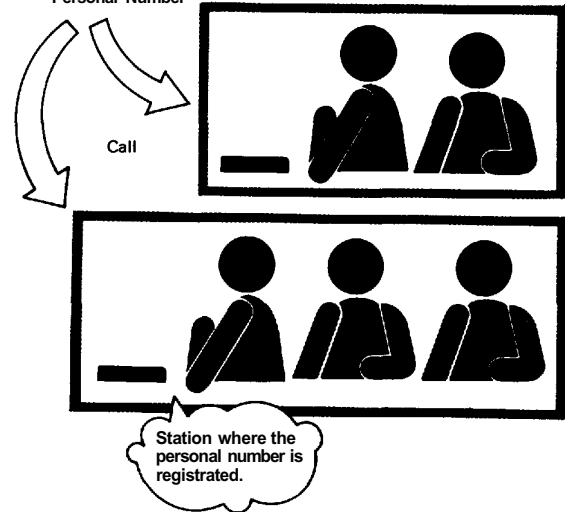
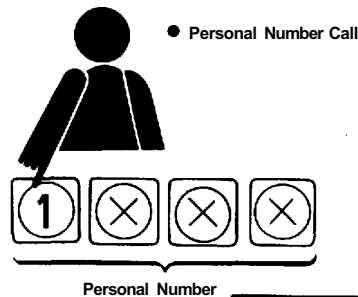
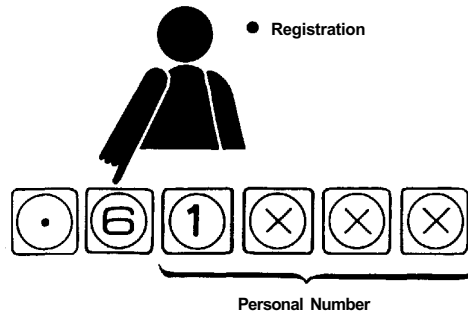

Continuous Calling Tone

When a specified station receives a call, the calling tone continues until

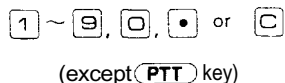

is depressed by this party.

1. When calls cannot be answered immediately or when it is difficult to hear a normal calling tone due to high background noise, the station should be provided with the continuous calling tone function. There is no limit to the number of stations that may be equipped with this function, but a No.200 registration must be completed.
2. When the caller depresses the **PTT** bar while the continuous calling tone sounds, he can talk to the person called by one-way. When the **PTT** bar is released, the continuous calling tone returns.
3. During two-way conversation, each party presses the **PTT** bar to talk and releases the **PTT** key to receive the other party. (Press to Talk)

Note.

1. In the event of the system without Privacy function (NP Type system), stations with Privacy switch in the ON position are called by a continuous calling tone. By No.200 programming, this continuous calling tone function may also be made available to the system having Privacy function (PV Type system) and to industrial type of station model HF-650M.
2. Two (2) different continuous calling tones may be employed in
 - (1) stations used in "NP" type system having a standard function of "continuous calling tone".
 - (2) specific stations provided with a "continuous calling tone" function by station No. 200 programming.

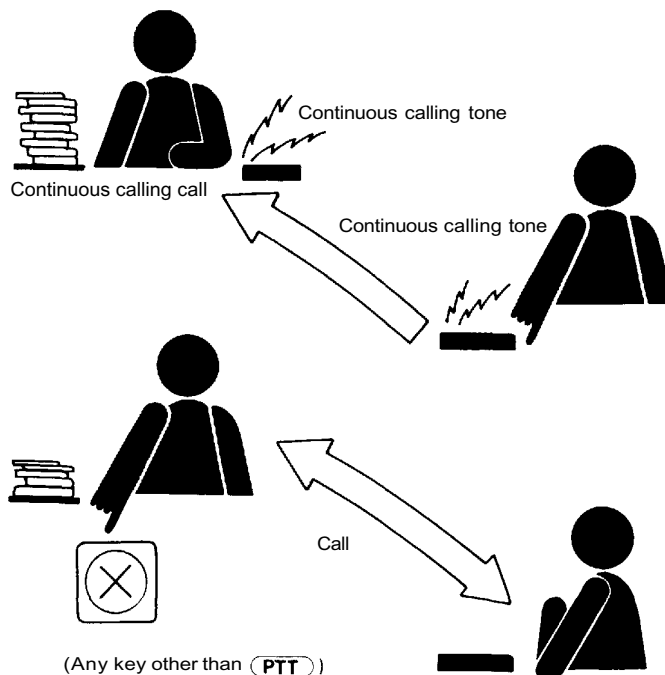

< Comparison of continuous calling tones >

Type of system	Type of station (Specific station provided with "continuous calling tone" function by station No.200 programming)	Nature of calling tone	
		Privacy switch in OFF position	Privacy switch in ON position
"PV" Type	Non-programmed station (standard)	Single "trill" calling tone (Call is put through immediately after calling tone)	Privacy tone
	Programmed station	Continuous calling tone	Privacy tone
"NP" Type	Non-programmed station (standard)	Single "trill" calling tone (Call is put through immediately after calling tone)	Continuous calling tone
	Programmed station	Continuous calling tone	Continuous calling tone
Responding to a call made by continuous calling tone		Depress any dial key other than PTT key.	<ol style="list-style-type: none"> 1. Depress only dial key other than PTT key. 2. Pick up a handset. 3. Shift Privacy switch to OFF.

Remote Response

This feature is available only among stations programmed for this purpose. When a station at which no one is present is called by means of a continuous calling tone, remote response to that call can be made by pressing the (PTT) key from any other station programmed for this function.

Note.

1. This function is only possible when a station is called by a continuous calling tone.
2. When this function is used from a station with the Privacy switch ON, press the (PTT) key, after lifting a station handset or after shifting the Privacy switch to OFF.

- ◆ Programming the remote response group
Establish the remote response group of stations and designate a specific station within the group as a temporary "Master station" and the rest as "Substations".

The Master station registers the number of his own station as follows.



Master's number

Each of "Substation" within the group registers the "Master" 's number by dialing



Master's number

Note.

Make sure that the temporarily designated master always registers his own station number at time of programming.

- ◆ Cancelling remote response program

Touch dialing at each "Substation"



His own Substation number

cancel Is the Remote reponse program.

Note.

When 2 or 3 exchanges are connected by tie-line, select the Remote response group within the stations connected to the same exchange.

- Dial operation for Remote response

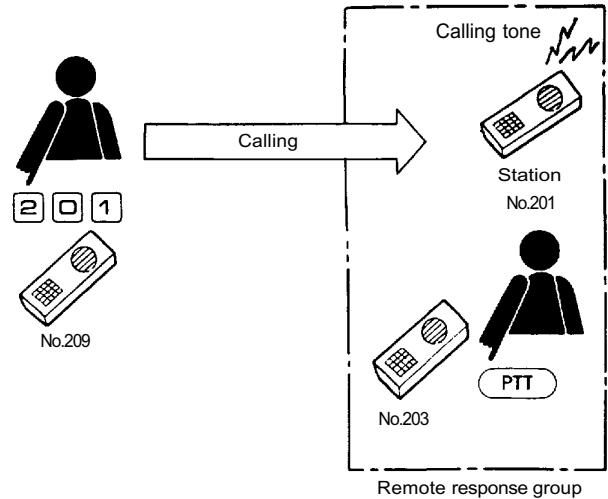

- Conversation after Remote response

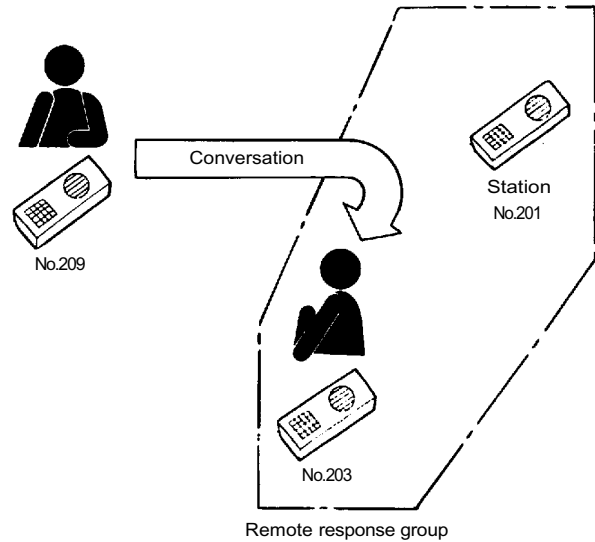

- Programming the remote response group (Example)

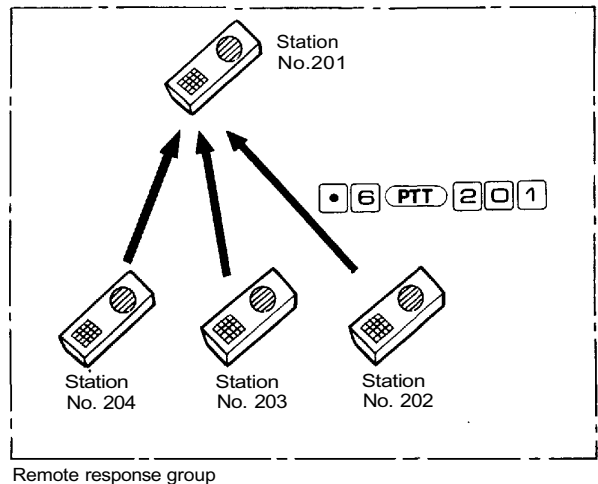

Call Transfer

Call Transfer from Called Station

During the conversation, first dial



(the Station Number of the person the call is to be transferred to).

The original call is then held and the holding tone is transmitted to the other party, while the third party is called and asked whether he will accept the call. If he agrees to accept the call, dial

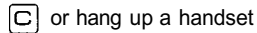

and the transfer will be completed.

This function allows called party to transfer that call to another station. The party to whom the call is to be transferred, may be called using either the Station Number, the Personal Number or through Single Digit Dialing.

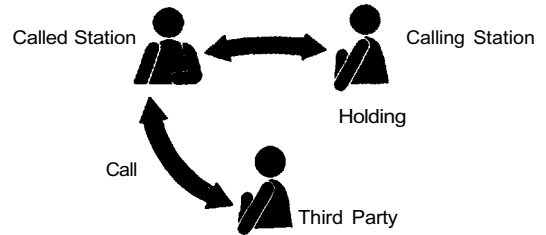
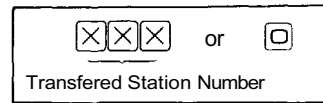
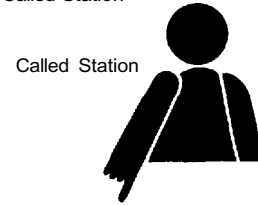
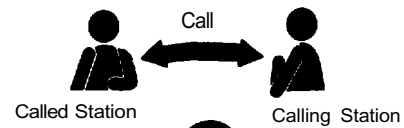

Call Hold and Call Back from Calling or Called Station

During the conversation, first dial



the Station Number of the third party.

The other party is then placed on hold as the third party is called. Upon completion of the conversation with the third party,

the party called touch dials the



key

or the third party touch dials the

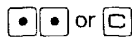

key

or the third party replaces a handset.

This allows the original conversation to resume.

The Transfer function is combined with the Call Holding function.

When two parties are talking, either one can be temporarily placed on hold to permit the calling of another station. The conversation with the third party over, the original conversation can be resumed.

The third party can be called using either the Station Number, his Personal Number or through Single Digit Dialing.

● Transfer

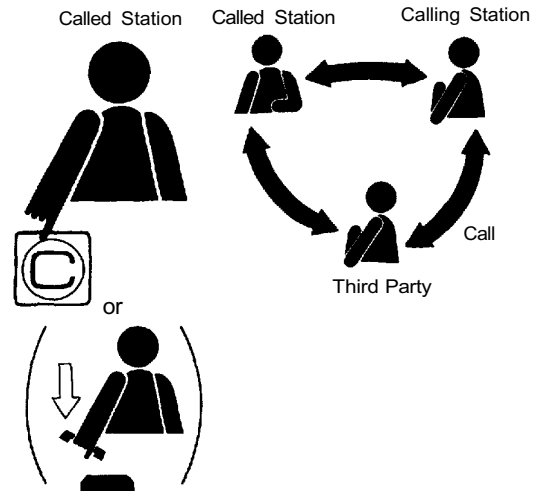

Note.

When 2 or 3 exchanges are connected by tie-line, an original call can be transferred only to the third party who shares the same exchange with the party who transfers the call.

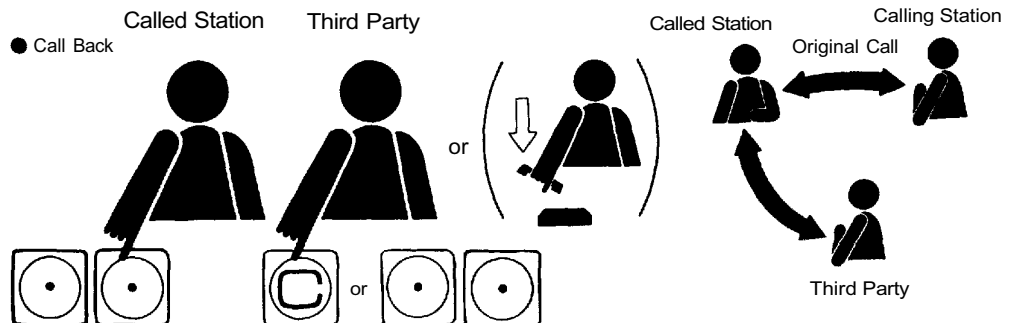



Paging during Normal Calls

A paging call can be made by a called party of an existing call to a third party, the third party's response accepted while the original call is on hold, and the original call resumed when the response call has ended.

Press  and the desired zone number. This puts the original call on hold and makes the External PA and or Station paging call. Then, press

 to restore the original call, and wait for the response to the paging call. When the response is received, press

 or replace the handset and the original call goes back on hold allowing the second call to be taken. When the second call is completed, press

 and the original call can be resumed.

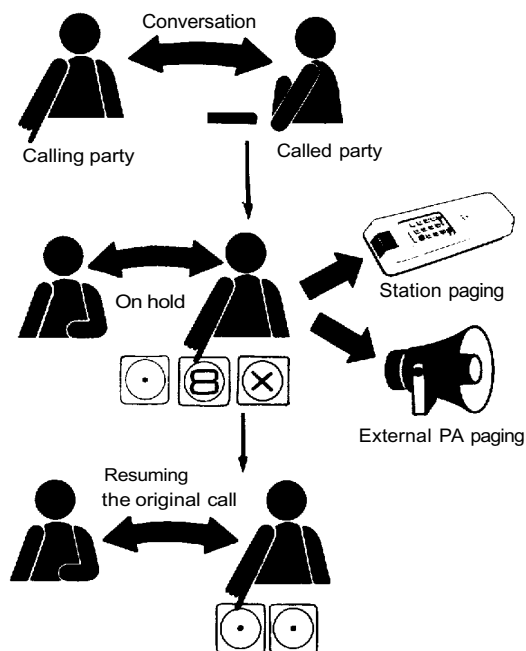

Note.

1. With adoption of the selective functions "Call Transfer" and "Paging", this function is allowed to activate.
2. When 2 or 3 exchanges are connected by tie-line, paging during a normal call is only possible within the paging zones allocated to the exchange to which a station making the paging is connected. And All-call paging during a normal call is impossible.

Group Hunting

When the party you are calling is on another line, your call is automatically rerouted to another station which is programmed from the beginning.

When the party to whom the call is rerouted is also on another line, the call can further be rerouted to the other station by programming.

Note.

1. To use this function, station No.200 programming of the station number(s) to which the call is to be transferred must be set up in the exchange. Place a DIP switch for Group Hunting in the ON position and make Group Hunting programming, so that this function can be programmed.
2. The combined use of this function with the "Secretary Transfer" function makes the system more functional. When "Secretary Transfer" function is employed, setting the Privacy switch to the ON position allows any incoming call to be automatically transferred to the other stations even when one is absent.
3. If station No. 200 programming is made so that the call can be rerouted to the station which is called first when the other stations registered are busy, then any call can be transferred automatically to another station. Similarly, the original call can be rerouted one after another in the "Secretary Transfer".
4. When 2 or 3 exchanges are connected by tie-line, select the station to which the call is to be transferred within the same exchange group.

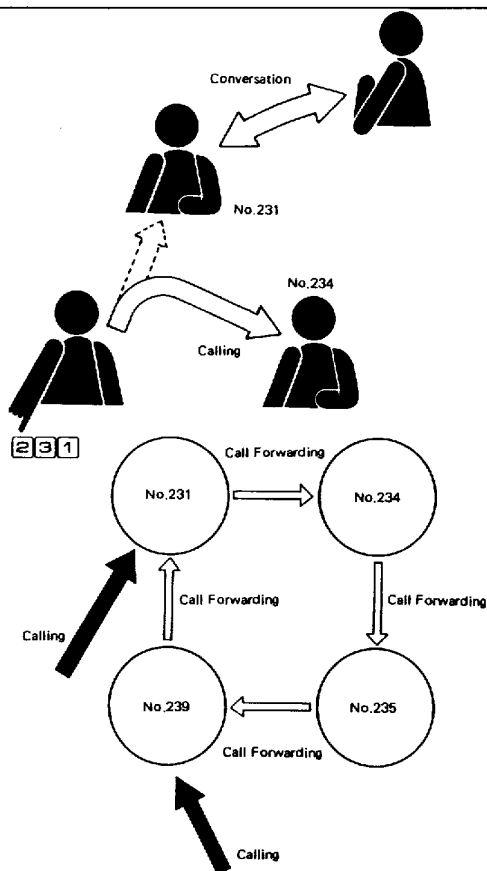

Secretary Transfer

This function is only available when a specified station is programmed for this purpose with use of Station #200 in the programming mode. Automatic transfer of incoming calls by an executive to his secretary is accomplished by placing the Privacy Switch on his station in the ON position.



This function allows a secretary to accept all incoming calls placed to an executive.

For the executive to accept calls directed to his station once the automatic secretary function has been programmed by station #200, he simply moves the privacy switch to the left, or OFF position.



It is also possible for the executive to accept calls at his station.

There is no limit to the number of Executive/Secretary pairings except by the number of available number combinations within a given system.

When a secretary who is already programmed for this function wishes another secretary to accept all incoming calls directed to an executive, station No. 200 programming of another secretary should be set up in the exchange. Then, the calls can be rerouted to another secretary if the executive and the secretary first registered place their Privacy switches in the ON position. It is also possible to transfer the call in a daisy chain method.

Note.

When 2 or 3 exchanges are connected by tie-line, set up a Secretary/Executive association within a group of stations connected to the same exchange.

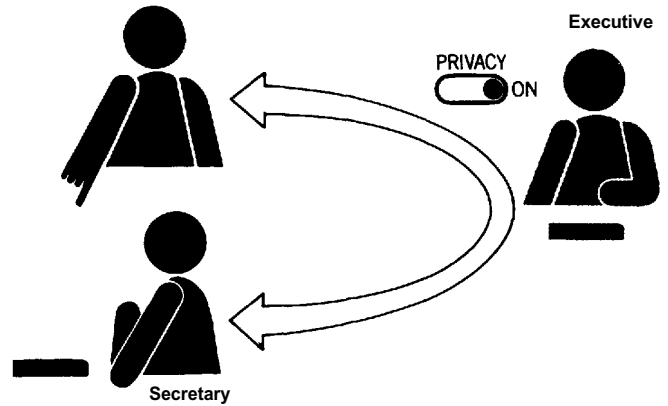

Digit the executive station.

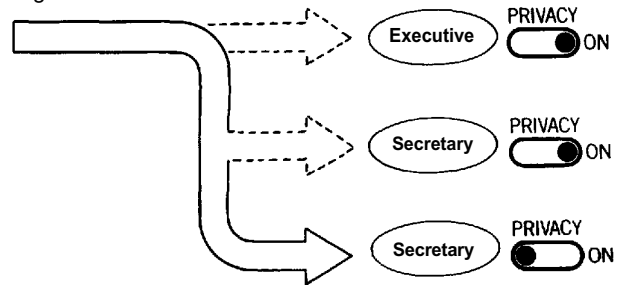

Adoption of the selective function "Transfer" allows rerouting of the call transferred to the secretary back to the executive's station.

When the secretary answering a call touch dials

Executive's station number

the privacy tone sounds continuously at both ends of the line, while the call is held. The call holding tone is transmitted to the calling station. If the executive shifts the privacy switch to the left position, or if he depresses any of the keys other than the PTT key (, , , ,) or picks up a handset he can talk with the secretary. If the call held is to then be transferred back to the executive's station, the secretary is to touch dial , or to hang up a handset, and the original calling station will be connected to the executive's station.

Secretary Transfer and Call Transfer using Single Digit Dialing

Adoption of the selective functions "Transfer" and "Single Digit Dialing" allows simple retransfer of the call transferred to the secretary back to the executive's station.

Touch dial

Executive's station number

at the secretary's station in advance. When the call transferred to the secretary has to be transferred back to the executive, the secretary simply touch dials

at her station. This sets the privacy tone sounding continuously at both ends of the line while the call is held. If the call is to be transferred back to the executive's station, the secretary touch dials or hangs up a handset.

The calling station will then be connected to the executive's station.

Reply from the executive, the secretary touch dials

This will then return the secretary to the original call.

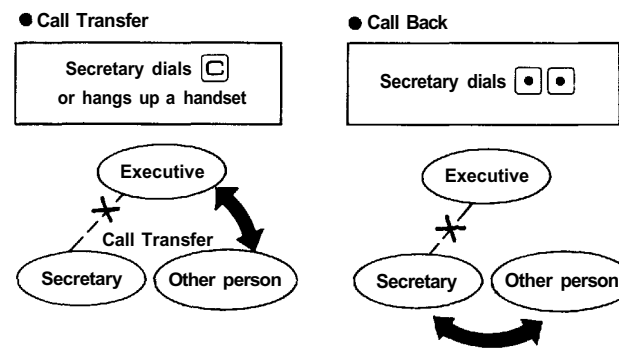
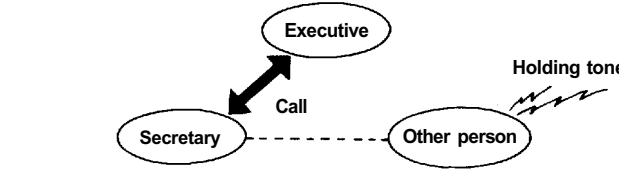
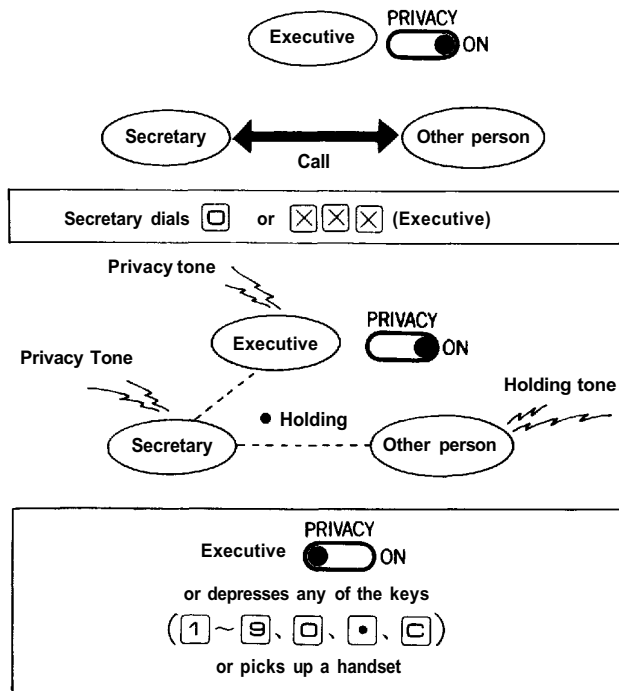

Secretary Transfer end Cell Transfer

NP Type

Adoption of the selective function "Transfer" allows rerouting of the call transferred to the secretary back to the executive's station.

When the secretary answering a call touch dials

☒☒☒

Executive's station number

the continuous calling tone sounds at both ends of the line, while the call is held. The call holding tone is transmitted to the calling station. If the executive shifts the privacy switch to the left position, or if he depresses any of the keys other than the PTT key (☐~☑, ☐, •, ☐), or picks up a handset he can talk with the secretary. If the call held is to then be transferred back to the executive's station, the secretary is to touch dial ☐, or to hang up a handset, and the original calling station will be connected to the executive's station.

Secretary Transfer and Call Transfer using Single Digit Dialing

Adoption of the selective functions "Transfer" and "Single Digit Dialing" allows simple retransfer of the call transferred to the secretary back to the executive's station.

Touch dial

•60☒☒☒

Executive's station number

at the secretary's station in advance. When the call transferred to the secretary has to be transferred back to the executive, the secretary simply touch dials

☐

at her station. This sets the continuous calling tone sounding at both ends of the line while the call is held. If the call is to be transferred back to the executive's station, the secretary touch dials

☐ or hangs up a handset.

The calling station will then be connected to the executive's station.

Reply from the executive, the secretary touch dials

••

This will then return the secretary to the original call.

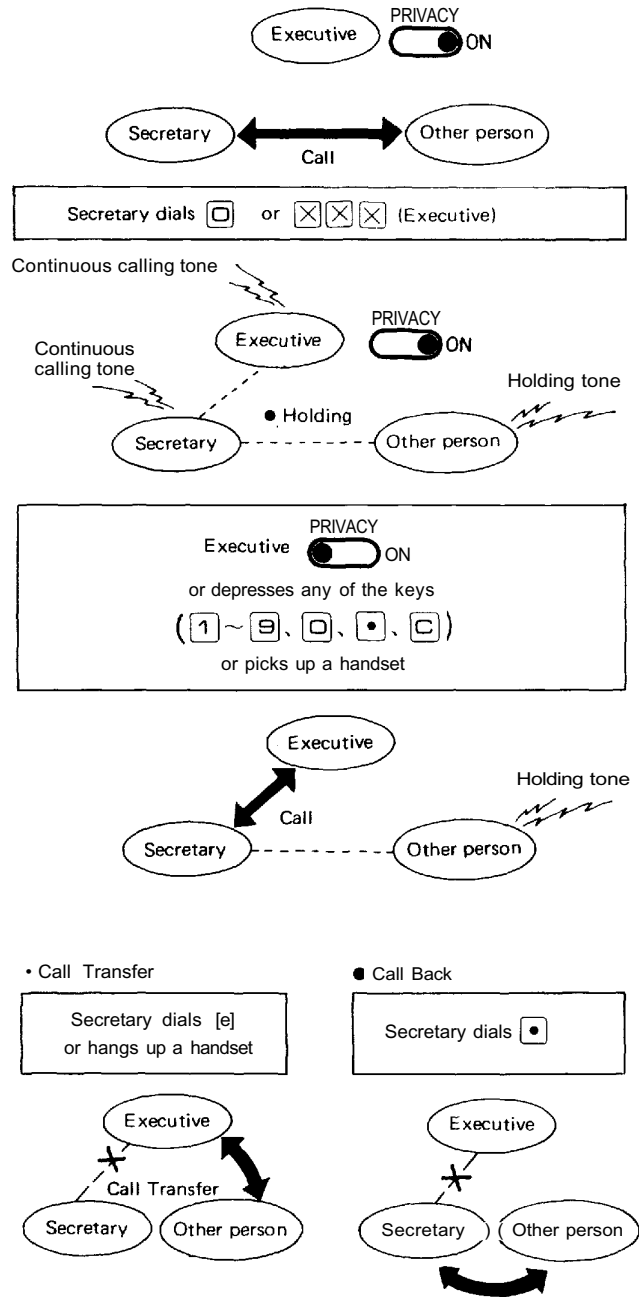

Call Forwarding

When you will be away from your station and wish all incoming calls to be rerouted to a different destination you are going to move to, you can do so by registering that station number before you leave.

◆ Registering Call Forwarding function

To program this function, touch dial **•6** plus the station number of the destination you are going to move to. The registration of this function may only be made at the original station and any previous programming made for this function is automatically cancelled each time the new programming is made.

◆ Cancelling Call Forwarding program

Touch dial

•6XXXX

Your original station number

at your assigned station.

Note.

1. Calls made in the following instances are directly put through to the original station even if call forwarding function is programmed.
 1. Calls from the destination station registered to the original station.
 2. Calls made by using a personal number registered at the original assigned station.
2. Before a call is automatically rerouted to the station registered with Call Forwarding function, a brief confirmation tone sounds at the original station, indicating that a call has been made and is going to be put through to the registered station.
3. This function is available only between stations within the same group when the system employs Group Blocking function. Even if it is possible to make a call between stations of different groups, Call Forwarding function cannot be registered between them.

● Registration of Call Forwarding

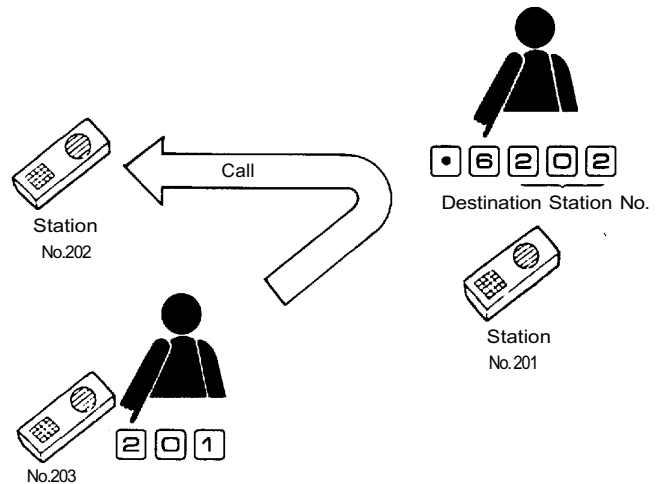

● Cancellation of Call Forwarding

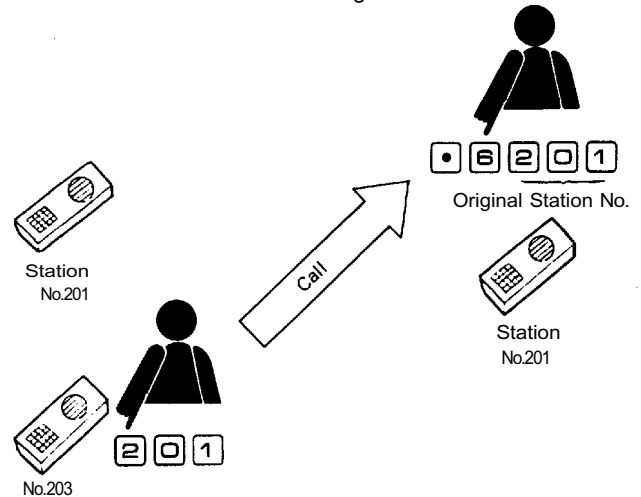

Priority

When the party called is on the line, as indicated by the busy tone, dialing



transmits a priority tone to the called party. The same tone is audible at the calling station. The call is connected if the called party also responds by dialing



In this event, the original conversation partner of the party called is temporarily placed on hold and the holding tone is transmitted to his station.

Upon completion of the priority conversation, the party who placed the priority conversation dials



or he hangs up a handset of his station. This allows the interrupted conversation to resume.

When the called party is already on the line, the party calling, if he deems it necessary, can send a Priority signal to the called party. After a response from the party called, the urgent call is allowed to take priority and go through.

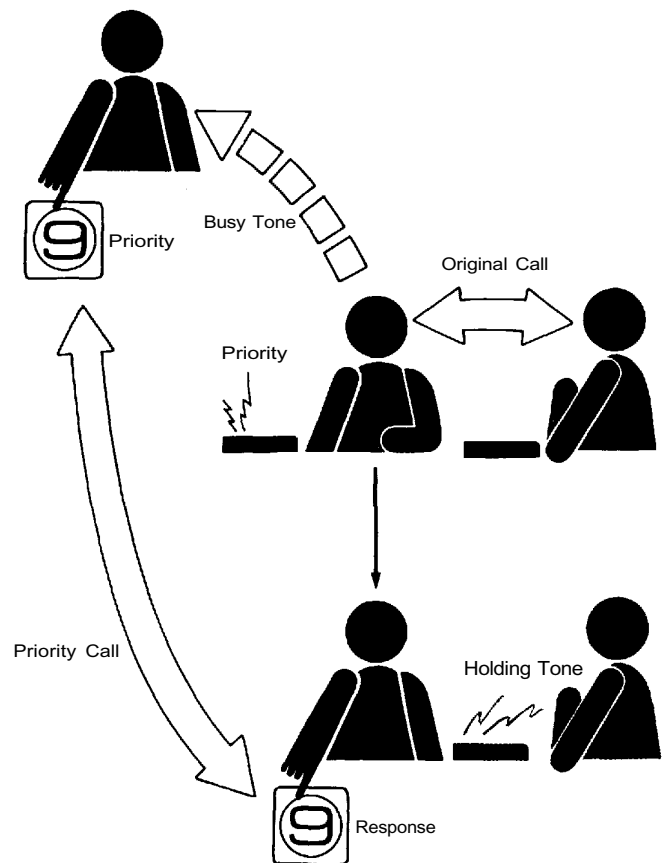

Executive Priority

This function is available only for those stations specifically programmed for this function, with programmed station #200. When the station called is busy or in the Privacy mode, as indicated by the busy or privacy tone, dialing



sends a priority tone. This priority tone is transmitted for a few seconds and then the call is put through.

In this event, the original conversation partner of the party called is put on hold and a holding tone is transmitted to his station.

Upon completion of the priority conversation, the party placing the priority call dials



or he hangs up a handset of his station to allow the original conversation to resume.

When the called station is busy or in the "Privacy" mode, this function allows forced interruption for priority conversation.

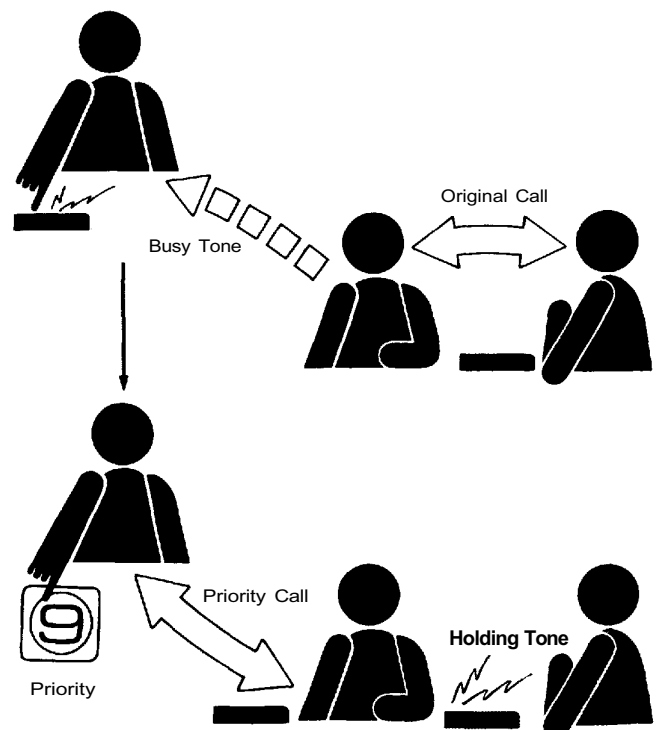

Highest Executive Priority

This function is available only for those stations specifically programmed for this function, with programming station No. 200. When the station called is busy, as indicated by the busy or privacy tone, dialing



sends a priority tone. This priority tone is transmitted for a few seconds and then the call is put through, terminating the original conversation.

When the called station is busy or in the Conference mode or during a paging call, this function allows forced interruption for priority conversation.

Note.

Either Executive Priority function or Highest Executive Priority function may be employed.

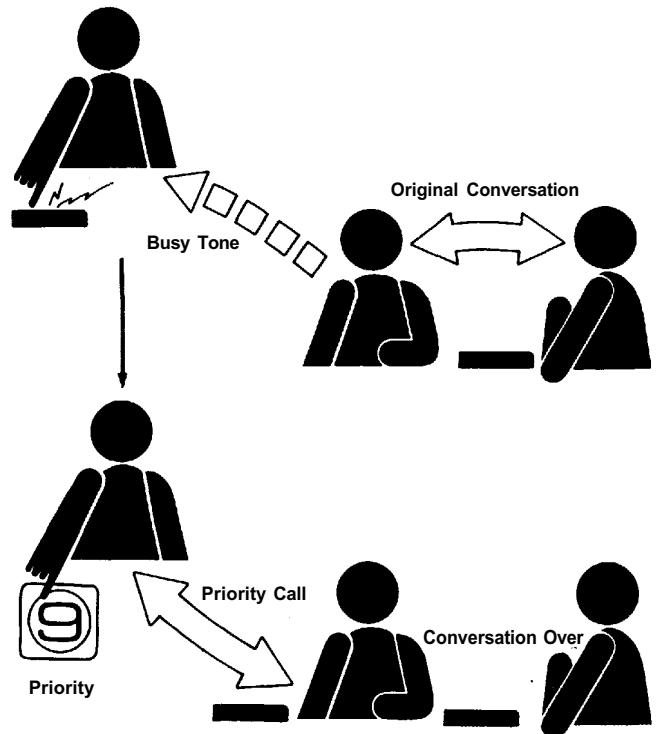

Conference

A "Hands-Free" conference call can be made with up to 4 persons. For a conference under this function the other participants may be called either through their station number, personal number or by Single Digit Dialing. Addition of stations or personal numbers (total of only 4) may be added by anyone already connected.

The person who proposes the conference may dial

• 5 X X X X

(Station Number of the 1st of the participants)

After receiving 2nd person's consent, he may then dial

X X X

(2nd participant)

After receiving 3rd person's consent, he may now dial

X X X

(the last participant)

At this point, the 4-man conference may begin. It is also possible for any of the 4 participants to call up any of the other participants.

A person wishing to drop out of the conference should dial

C or hangs up a handset

at his station.

Any of the participants who wish to drop out during the conference may do so as long as it's not the party who originated the conference.

The function is cancelled and the normal mode is restored when the person who arranged the conference dials

• •

In the event that the calls made by the person arranging the conference are not answered or that there has been a dialing error, the function can be cancelled for restoration to the normal mode.

The conference is terminated when the party who arranged the conference dials

C or hangs up a handset

When the conference has been terminated by the party who originated it, the other participants cannot continue the conference.

Either of the parties in conversation is to dial

• 5 X X X X

(the Station Number of the third party).

It is possible for persons in normal conversation to change to the Conference mode without interruption.

- A "Hands-Free" conference call can be made with up to 4 persons.

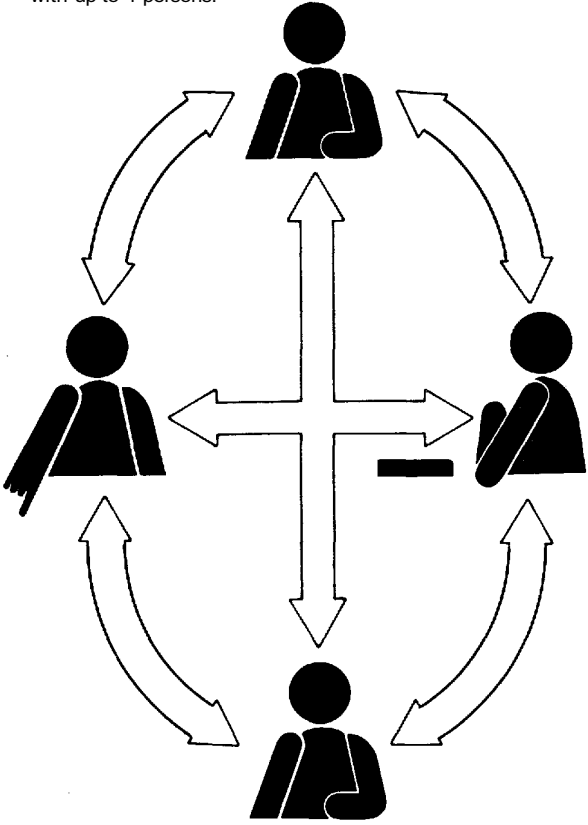

- Dialing of conference member.

• 5 X X X X
Station number

• 5 1 X X X
Personal number

• 5 0
Single Digit

Paging

A variety of paging modes allows paging over a wide area from any master station. The paged party may respond from the nearest master station.

Paging modes include external PA systems and/or Station paging and Zone paging is for calling a limited area, and All-call paging is for calling over the entire area.

Response to a paging call may be made by means of Automatic response or Zone number dialing.

1. External PA paging and Station paging

A. External PA paging

1. Paging through external speakers is possible from any master station, with the paged party able to respond from the nearest master station.
2. External PA paging zones and all-call paging are possible up to a maximum number of 31 zones (zone 1 through 31).

B. Station paging

1. Paging from any master station to all stations within a certain area is possible through the station speakers. But the page will not be heard at stations in use in the area.
2. Station zone paging and all-call paging are possible only within zone 1 through 31.

2. Zone paging and All-call paging

A. Zone paging (Individual zone paging).

Paging and Paging response are possible through Zone paging. To page a specific zone, press $\square \square$ and the zone number. To respond to a zone page, press simply $\square \square$ or $\square \square$ plus the zone number.

Paging to zones 1 through 31 may be made through external PA paging using the external amplifiers and speakers, and/or through station paging using the station speakers.

B. All-call paging

Paging and Paging response for External PA and/or station paging is possible through All-call paging. To make an all-call page, press $\square \square \square$ (maximum of 9 zones) or $\square \square \square \square$ (maximum of 31 zones). To respond, press $\square \square$ or $\square \square (\square) \square$.

This does not necessarily mean that All-call station paging must reach all the stations.

3. Responding to a paging call

A. Automatic response

1. Zone paging response

Touch dialing $\square \square$ at the station within the paged zone permits a response to the party who placed a paging call.

In this event, No.200 registration of the stations (consecutive station numbers) within each zone must be made.

2. All-call paging response

Touch dial $\square \square$ at any station and the paged party is put through to the party calling.

B. Zone number dialing

1. Zone paging response

The paged party is connected to the party calling by depressing.

$\square \square (\square) \square$ (Zone number)

at any station.

2. All-call paging response

Depressing $\square \square (\square) \square$ or $\square \square$ permits a response to the party calling.

Other Paging Modes

1. Combination paging

Combination paging is used when several zones must be paged simultaneously through External PA or Station paging. A special paging area can be created wherever the paging ranges overlap by combining several zones. A maximum of 10 combinations can be created in this way from a maximum of 31 individual zones.

2. Emergency all-call paging

Emergency external PA or station all-call paging can be made either from the specified station (No.247) or by an external input signal connected to line No.247. All normal calls and pages are interrupted for the duration of the emergency All-call page, returning to normal when the page is terminated.

3. Paging priority

In normal station paging, the page is not heard at any station already in use. By using the paging priority function, the call can be interrupted to allow the page to go through. A holding tone sounds at the other party's station, and the call is restored when the page is terminated.

Note.

Dial operation of Combination paging

- Paging call



Combination zone No.
(90~99)

- Paging response



Combination zone No.
(90~99)

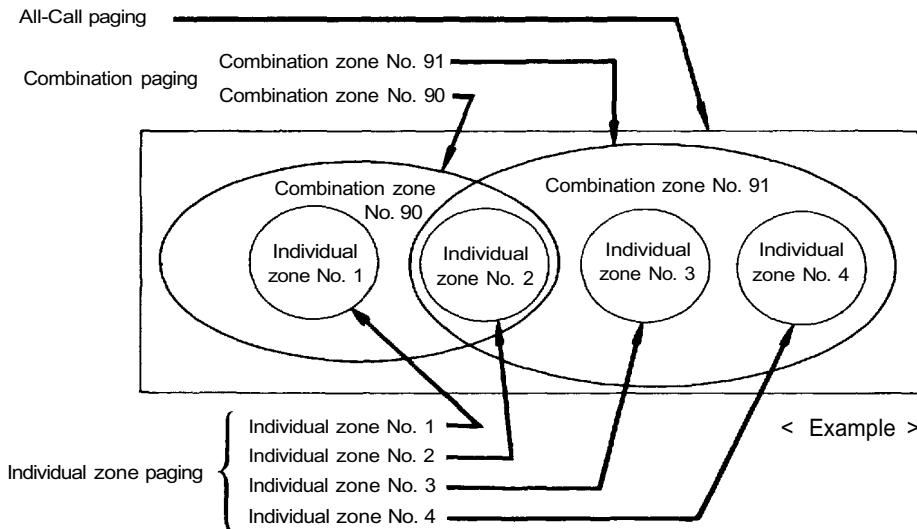

Note: Priority of Paging

Emergency all-call paging > All-call paging > Combination paging = (Individual) zone paging

1. The higher priority page overrides the lower priority one. The lower priority page will be restored when the higher priority page is terminated.
2. Individual zone pages made while a Combination paging is in progress will result in Camp-On-Busy.

How to select the paging area and make the paging call.

Paging functions may include both external PA and stations, depending on the zone being used. The paging area is limited to individual zone, Combination paging and All-call paging depending on the call range.

Paging area	Dialing operation				
	No.	Paging call		Response	
		All-call and maximum of 9-zone paging.	All-call and maximum of 15-zone paging.	Automatic response	Zone number dialing
All-call paging	0	• 8 0	• 8 0 0	• 0	• 0 or • 9 (0) 0
Zone paging up to 31 zones	1 ~ 31	• 8 X Individual zones (1 ~ 9) *(1 ~ 8)	• 8 X X Individual zones (01 ~ 31)	• 9	• 9 (X) X Individual or Combination zones
Combination paging of up to 10 zones	90 ~ 99	• 8 9 X Combination zone(90-99)			

*This applied when the Combination Paging is used.

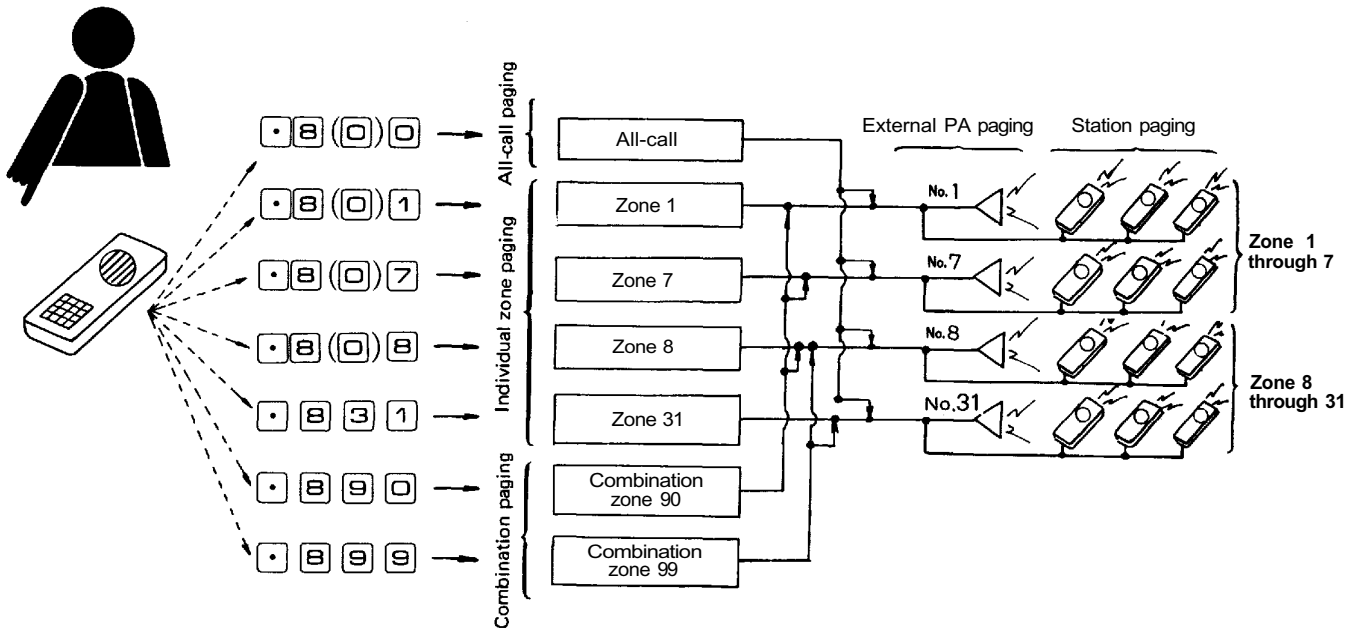

< Example >

All-Call Paging and Individual Zone Paging

◆ Paging call

External PA paging to a specific zone is possible from any master station by pressing

or ('0' or '00' = all-call)
1~9(1~8*) (00~31)

and the desired zone number ('0' = all-call). It is possible to wait for a response in this mode, but anything said will be broadcasted over the entire zone. It is best to end the paging call by pressing

or hanging up a handset

and waiting for a response.

Paging to zones 1 through 31 may be made through external PA paging using the external amplifiers and speakers, and/or through station paging using the station speakers. All zones are paged at the same time by all-call paging.

Note.

* This applies when the Combination Paging is used.

◆ Paging response

1. Automatic response

To respond to a paging call, go to the nearest master station and press either

(All-call paging response)

or

(Zone paging response).

2. Zone number dialing

To respond to a All-call paging, go to the nearest master station and press

() or

To respond to a Zone paging call, press

()

Zone No. 1 ~ 9 (01 ~ 31)

at the nearest station.

Note 1: When all-call paging is initiated during zone paging, the Zone paging is interrupted and restored after the all-call paging is finished.

Note 2: To respond to Zone paging by pressing , No.200 registration of the stations (consecutive station numbers) within each zone must be made. Such registration is required for both external and station paging. For further details, please refer to Installation Hand Book for EXES-6000 CP unit.

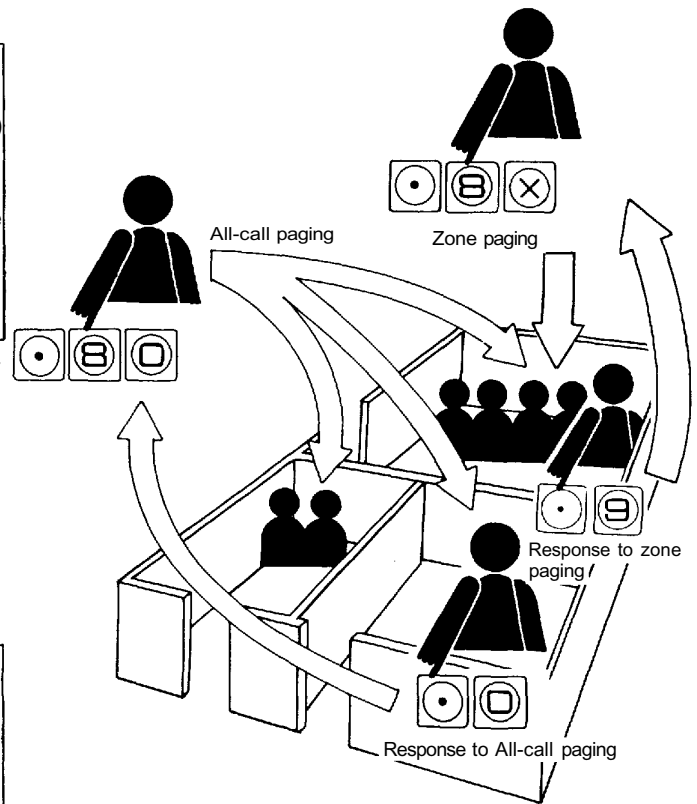

Table of stations used for individual zone paging. (Example)

Zone numbers	First station number	Last station number
1	2 0 1	2 0 3
2	2 0 5	2 0 7
3	2 1 0	2 1 9
4		
5		
6		
7		
8		
9		
1 0		
1 1		
1 2		
1 3		
1 4		
1 5		
1 6		
1 7		
3 0		
3 1		

Combination Paging

Several zones can be called simultaneously using external PA paging and station paging. This is combination paging and is initiated by pressing

• 8 9 X
90 ~ 99

Paging will be broadcast to predetermined zones. It is possible to wait for a response in this mode, but it is usually preferable to terminate the paging call and wait for a response. The paged party can respond by pressing

• 9 or • 8 9 X
90 ~ 99

at the nearest station. Refer to Example 1.

Priority of paging

All call paging > combination paging = individual zone paging

1. When some stations are already receiving another combination paging, the second paging call will be put on camp-on-busy. Refer to Example 2.
2. When some stations are receiving individual zone paging, a combination paging call will be put on camp-on-busy.

Likewise, when a combination paging call is being received, individual zone paging calls will be put on camp-on-busy. Refer to Example 3.

Responding to combination paging and zone paging

1. Automatic response

To respond to zone paging or combination paging, press

• 9

When the same zone is called via both zone paging and combination paging, responses will be put through to the station calling last. Refer to Example 4.

2. Zone number dialing

To respond to the (individual) zone paging call, depress

• 9 (X) X
1 ~ 8
(01 ~ 31)

Depressing

• 9 9 X
(90 ~ 99)

permits the response to the combination paging call.

< Example 1 > Combination of individual zones

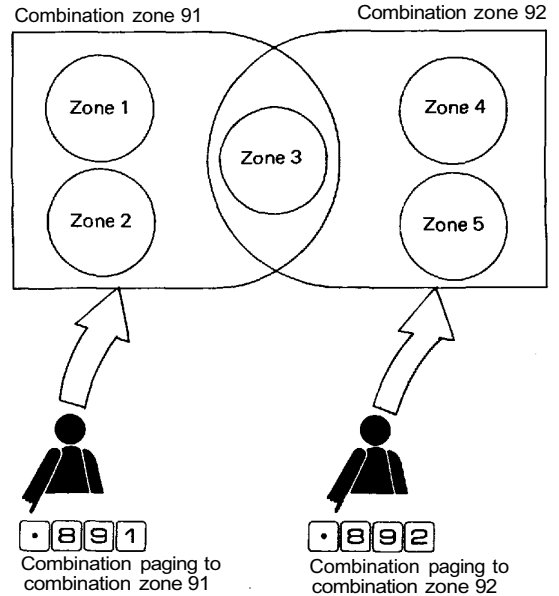

< Example 2 >

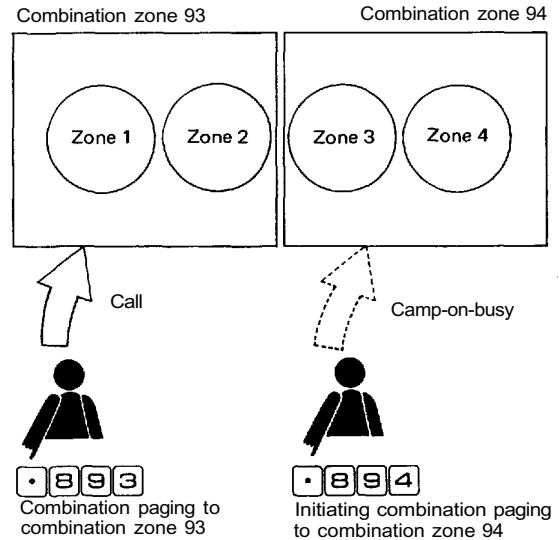

< Example 3 >

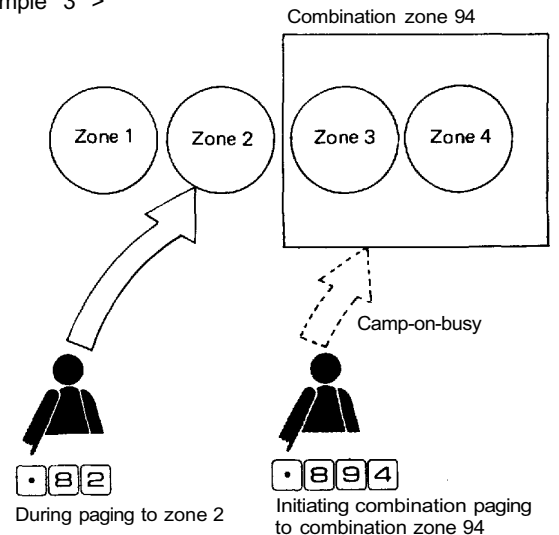

< Example 4 >

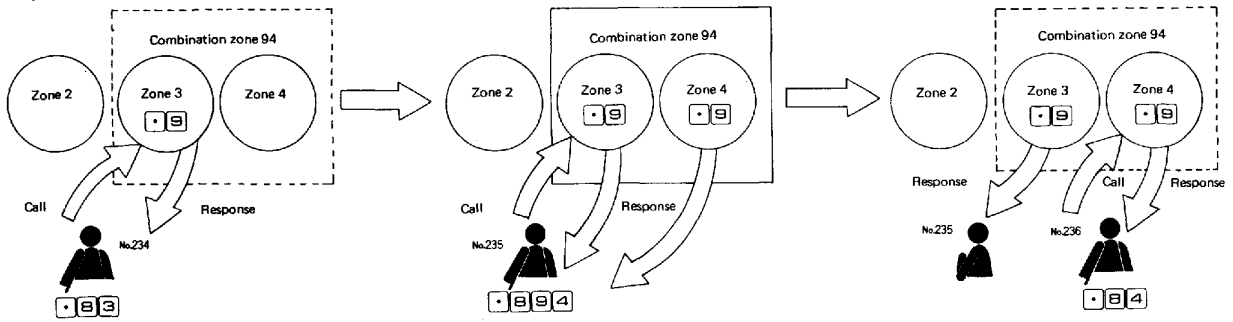

To operate combination paging, No. 200 registration indicating the individual zones to be included in the combination zone must be made.

For further details, refer to Installation Hand Book for EXES-6000 CP unit.

Programming for Example 1.

Combination zone	Dialing	Individual zone																
			1	2	3	4	5	6	7	8	9	10	11	29	30	31		
90	• 8 9 0																	
91	• 8 9 1		○	○	○													
92	• 8 9 2				○	○	○											
93	• 8 9 3																	
94	• 8 9 4																	
95	• 8 9 5																	
96	• 8 9 6																	
97	• 8 9 7																	
98	• 8 9 8																	
99	• 8 9 9																	

Emergency All-Call Paging

Handset substation TL-600S should normally be used for the emergency all-call station, No. 247.

To broadcast emergency all-call paging, pick up a handset.

The highest priority all-call paging can be broadcasted to all zones without pre-announcement of paging. During emergency all-call paging, all other paging calls and normal calls are interrupted until the handset is replaced and the emergency message is finished.

1. This function may be used to announce emergency instructions from the specified station No.247. It may also be used to provide the signal tones such as chime or alarm signals when the signal sources are fed to No.247 circuit.
2. To make emergency all-call paging from the specified station No.247 using Hands-free type of station, move the privacy switch from "ON" to "OFF" position.

< Emergency all-call paging is made >

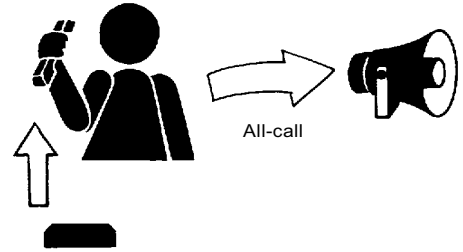

< Emergency all-call paging is finished >

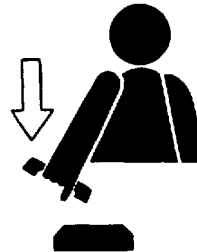

Paging Priority

When using the standard paging functions, paging is not heard while other calls are in progress.

Using paging priority:

1. Dial



(zones: 1—9, all-call: 0),



(zones: 01—31, all-call: 00), or



(combination zones: 90—99).

When the station being paged is already on the line, the call is interrupted. And the calling party is put on hold while the paging message is delivered. Refer to Example 1.

2. The calling party will be restored after the paging message is finished and his original conversation may be resumed. *

3. If the person paged wishes to respond immediately, he should dial

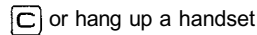

to terminate his original conversation and then dial



(zone paging or combination paging response)

or



(all-call response).

*: Conversation made at a station with its Privacy switch in ON is not resumed once interrupted. (The EXES-6000 System permits the station in Privacy mode to make or receive a call.)

Note 1: If the station called is in the process of dialing when station paging is initiated, paging will not be heard at that station and the call can be completed without interference.

Note 2: If a station being paged with station paging is called by a third party, camp-on-busy will result. Refer to Example 2.

Note 3: If any station in a given zone (zone 1, for example) pages another zone (zone 2, for example), station paging to stations in zone 1 results in camp-on-busy. Refer to Example 3.

Note 4: If station paging priority is used, the station numbers within the zone area must be programmed at station No. 200.

(1) To determine areas where conversation is interrupted by station paging priority.

(2) To determine zones to permit automatic response to zone paging from the paged station. (See Note 2 of Paging.)

Note 5: when system incorporates Station paging and PA paging at the same time, employ the Zone number dialing method (*9(X)X) for dial operation made when responding to the page. Also, set up "Station No. 200 programming" for Station paging priority. If the Automatic responding method (*9) is employed, then "No. 200 programming" need to be set up for every station and conversation is interrupted each time the External PA paging is made.

< Example 1 >

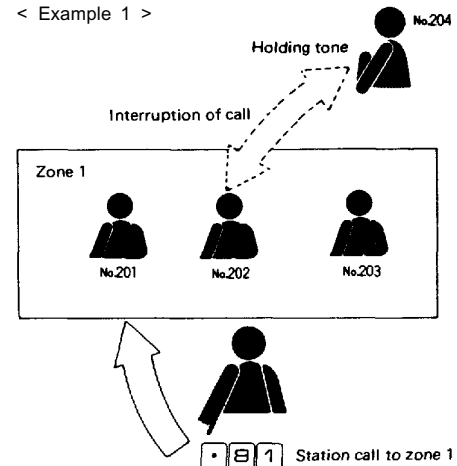

< Example 2 >

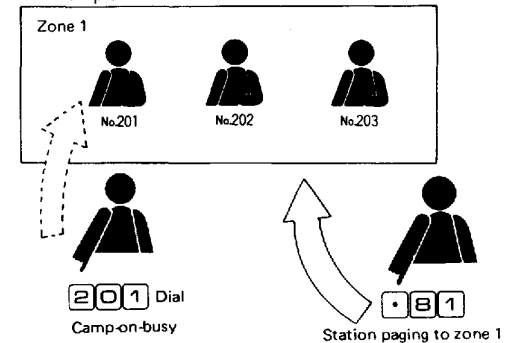

< Example 3 >

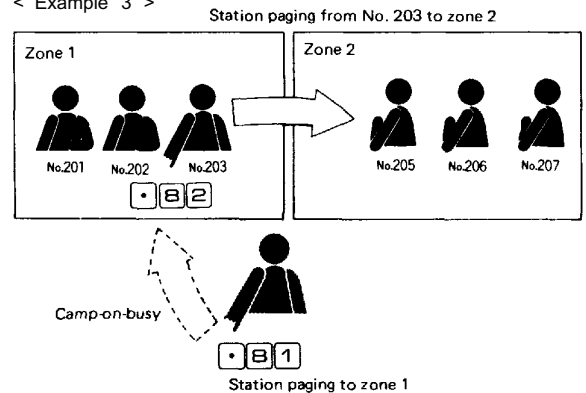

Programming for Example 1, 2 and 3

Zone numbers	First station number	Last station number
1	2 0 1	2 0 3
2	2 0 5	2 0 7
3	2 1 0	2 1 9
4		
5		
6		
7		
8		
9		
1 0		
1 1		
1 2		
1 3		
1 4		
1 5		
1 6		
1 7		
3 0		
3 1		

Personal Number Paging

If you wish to receive personal number paging calls, you may register your personal number at any station assigned in your desired paging zone by dialing

• 6 1 X X X confirmation tone is heard.

Your personal number

A calling party who wishes to speak to you can page you automatically in the specific zone if he dials your personal number.

1 X X X

Your personal number

To respond to a paging call, press • 9 on the nearest master station.

This function allows those who are frequently away from their original station to be paged automatically in the area where they are available, if personal number registration is done.

When you move from that registered area to another, make the same programming again.

When you leave the office, cancel the personal number registration, which may be done from any station by dialing

• • 1 X X X confirmation tone is heard.

Your personal number

With your personal number cancelled, any incoming call to your number will be answered by a dial tone, indicating that you are not available.

Note.

1. There is no limit to the number of personal numbers that may be registered at any single station, but the personal numbers which are used in this function are No. 1000 through 1999.
2. Either the personal number call function or the personal number paging function is selectable.
3. No.200 programming of station numbers assigned to each paging zone must be done for the • 9 response.
4. In the systems where the zone number must be pressed to respond to a paging call, dial • 9 (X) X for paging response.

• Registering a Personal Number

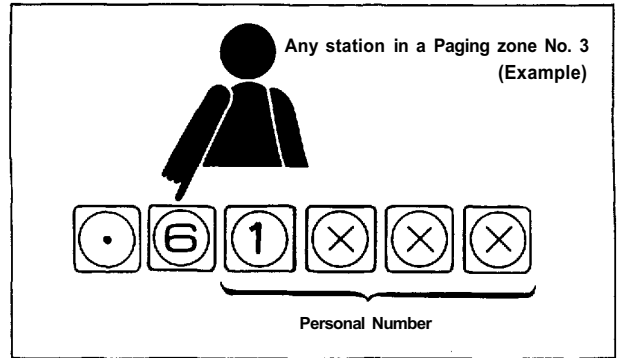

• Calling from any master station

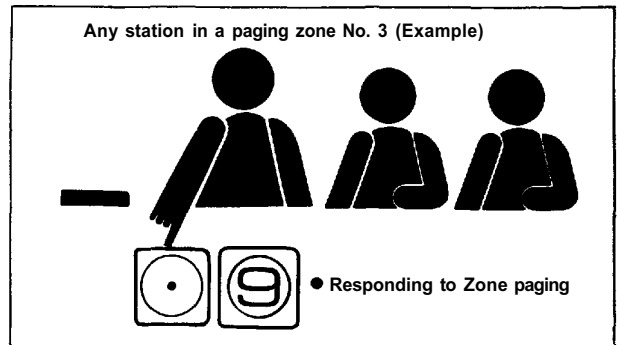
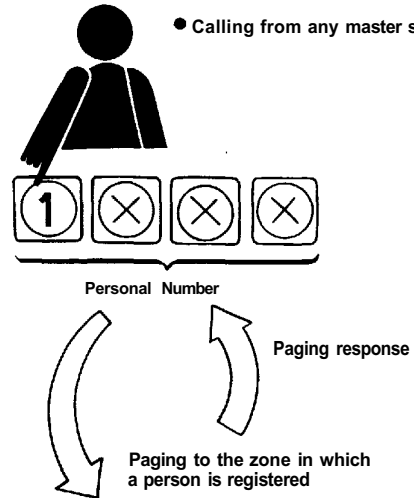

• Cancelling Personal number

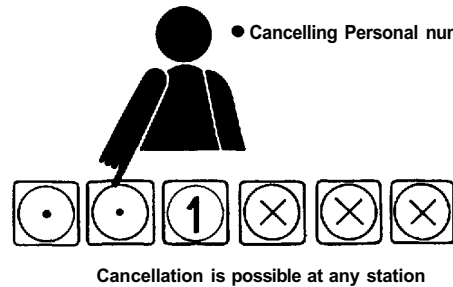

Selectable First Station Number

The first station number for system may be selected from any of the following numbers (Hardwired station number): 100/200/300/400/500/600/700/800/900.

The system with Personal Numbers can't use No. 100 ~ 199.

Note.

Station No. 200 programming is required when any other numbering schedules than standard (No. 200 ~) are used.

Programmable Station Numbering

This function allows the system to have "Programmable station numbers", other than the "Hardwired station numbers" by programming.

The unprogrammed stations are used as original hardwired station numbers.

Type of dial operation	Hardwired station number	Programmable station number
With Personal number	No.200 ~ 455	No.200 ~ 999
Without Personal number	No.100~355	No.100 ~ 999

1. Numbering schedules can be changed easily by programming in stead of rewiring.
2. Numbering schedule (such as 200's, 300's, 900's) is available for convenient office differentiation, (architectural numbering).
3. Normally, station numbers which are included in a station paging zone must be sequential, but programmable station numbers can be randomly included in a station paging zone.
4. This function is programmed at station No.200. Please see Installation Instructions for EXES-6000 CP unit.

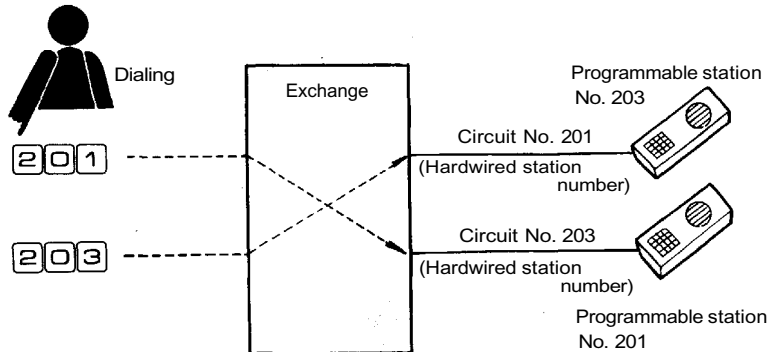

5. People operating the intercom stations need not be aware of the Hardwired station numbers. However, care must be taken when programming using station No. 200 in the exchange, as hardwired station numbers must be used for that purpose.

< Example >

Hardwired station number	Programmable station number	
2 0 1	2 0 1	} Department 1
2 0 2	2 0 2	
2 0 3		
2 0 4	3 0 1	} Department 2
2 0 5	3 0 2	

Hardwired station number	Programmable station number	
2 0 1	2 0 1	} Station paging zone
2 0 2	2 3 1	
2 0 3	2 4 1	

Hardwired station number	Programmable station number
2 0 0	→
2 0 1	2 0 3
2 0 2	→
2 0 3	2 0 1
3 2 6	→
3 2 7	→

Group Blocking

Function (A) . . The system can be grouped or divided into a maximum of 8 groups of stations with sequential station numbers. Stations in the group cannot call another.

Function (B) . . The group can call and/or be called by any other group (s) by programming.

< Example >

Fig. 1

Function (C) . . The paging zone number (all-call, individual zone and combination) which each group can call is programmable. (No distinction is made between external and station paging.)

Fig. 2

Fig. 3

Note.

- When the paging call is made, the group of stations to which the response is made is restricted by Function B. Function B permits the normal station call in the direction of the arrows. Its paging response can be made in the opposite direction of the arrows. (Refer to Fig. 4)

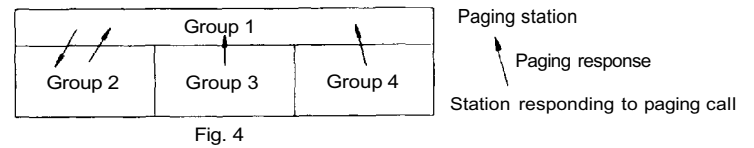

< Example of Paging response >

When the programming is set up for the normal station call as is shown in Fig. 2, the paging response is only possible in the direction of the arrows of Fig. 4.

Note.

- To use this function, station No. 200 programming of the allocated station number, group, paging zone, etc., must be set up in the exchange. For further details, please refer to Installation Hand Book for EXES-6000CP unit.

< Programming for Fig. 1, 2, 3 and 4 >

Station for each group		Group No. of calling station		Group No. of station receiving call		Paging zone of station receiving call																															
						All-call		Zone No.										Combination zone No.																			
First station number	Last station number	1	2	3	4	5	6	7	8	X	00	01	02	03	04	05	06	07	08	09	10	28	29	30	31	90	91	92	93	94	95	96	97	98	99		
2 0 1	2 0 9	1	⊙	⊙	⊙	⊙				⊙	⊙																										
2 1 0	2 1 9	2	⊙	⊙						⊙																											
2 2 0	2 4 9	3			⊙					⊙																											
2 5 0	2 7 9	4				⊙				⊙					⊙																						
		5					⊙			⊙																											
		6						⊙		⊙																											
		7							⊙	⊙																											
		8								⊙	⊙																										
Station not in group		X	⊙	⊙	⊙	⊙	⊙	⊙	⊙	⊙	⊙	⊙	⊙	⊙	⊙	⊙	⊙	⊙	⊙	⊙	⊙	⊙	⊙	⊙	⊙	⊙	⊙	⊙	⊙	⊙	⊙	⊙	⊙	⊙	⊙	⊙	

This chart shows the possibilities for one sample set of conditions.

- ⊙ indicates that registration is not necessary.
- × indicates that the station is not within the group.

< Example >

Selectable Calling Tone

The duration of the calling tone can be set for either 0.2 second (single note tone) or 0.3 second (warble tone). It is also possible to have the station without any calling tone.

Note.

1. The duration of the continuous calling tone is impossible to change.
2. Different modes of the duration of the calling tone may not be employed in each station within the same system.

Selectable Paging Pre-Announcement Tone Duration

The duration of the all-call and zone paging tones can be set for either 2 seconds ("long") or 1 second ("short"). It is also possible to have the system without any paging pre-announcement tone.

Time-Out of Conversation

It is possible to limit the conversation duration to one through ninety-nine minutes in the unit of one minute in order to improve speech path availability. A hurry-up tone is sounded in both the calling and called stations approximately 10 seconds before the busy stations are automatically disconnected from the speech path.

Time-Out of Paging Call

This function is employed to prevent the unnecessary line occupation as a result of a paging party's failure to depress the key after a paging call establishment. The paging call is automatically cancelled after a certain period of time, which may be set at one through ninety-nine minutes in the unit of one minute, with a hurry-up tone transmitted to the paging station approximately 10 seconds prior to the automatic disconnection. When the paged party responds, the conversation is automatically cut off after the duration set by the Time-out of conversation function.

In/Out Annunciation

The in/out annunciation indicators can be turned on or off from any master station by using the personal number registering procedure.

When a personal number registration is made at a station, by dialing

• 6 1 X X X

1000~1999 (personal number)

the personal number is registered at that station and the personal number lamp on the in/out indication panel is turned on.

Personal number call

By dialing

1 X X X

1000~1999 (personal number)

from any station, the call is put through to the station registered with the personal number.

Cancelling personal number and turning off in/out annunciation.

By dialing

• • 1 X X X

1000~1999 (personal number)

from any station, the personal number is cancelled and the personal number lamp on the in/out indication panel is turned off.

1. The maximum number of in/out annunciation windows is 1000.
This maximum number remains same even if the number of exchange to be connected is increased to 2 or 3.
2. The in/out indication panel must be used with the Data Transmitting and Receiving Units (DT-E11 and DR-B61).

In/out indication panel

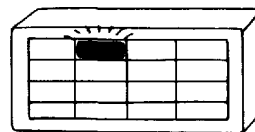

Lamp on

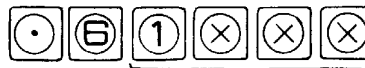

Personal number

In/out indication panel

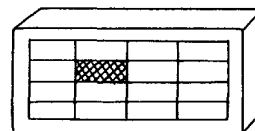

Lamp off



Personal number

Destination Annunciation Indication

When a personal number is registered at the station of the destination a person has moved to, the corresponding lamp on the destination indication panel comes on, indicating where he is.

When a personal number registration is made at any station (No. 201 ~ 232) by dialing

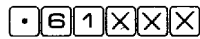

1000 ~ 1031 (personal number)

the personal number is registered at that station and the registered station's lamp on the destination indication panel comes on. No personal number (1032 ~ 1999) that has been registered is indicated on the panel. Registering the same personal number at another station causes the original station's lamp to extinguish and the new station's lamp to come on.

Personal number call

By dialing

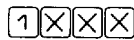

1000 ~ 1999 (personal number)

from any station, the call is put through to the station registered with the personal number.

Cancelling Personal number registration and turning off Destination indication

By dialing

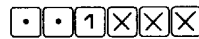

1000 ~ 1031 (personal number)

from any station, the personal number program is cancelled and the registered station's lamp on the destination indication panel goes out.

Note.

1. The personal numbers which may be assigned to this function are from No. 1000 through 1031.
2. The station numbers which may be assigned to this function are No. 201 through 232. Registering the personal number at any other station than those specific stations causes the lamp of station registered with the same personal number to go out.
3. The destination indication panel must be made with use of the Data Transmitting and Receiving units. For further details, please refer to instruction manuals for the DT-E11 and the DR-B61.

The lamp on the Destination panel is turned on

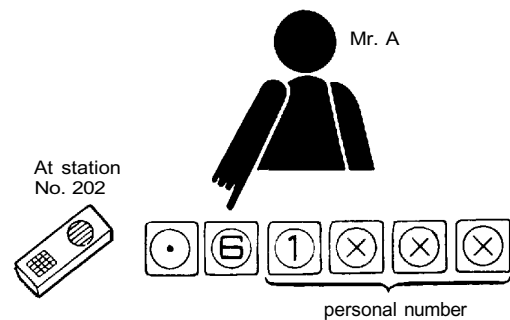
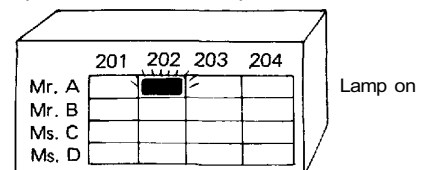

The lamp on the Destination panel is turned off

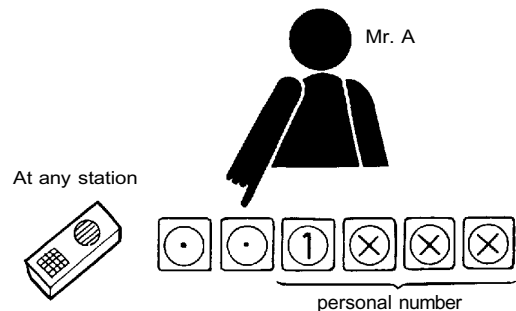
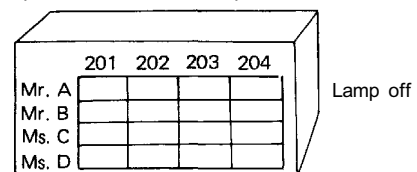

Calling Party Indication (Lamp Type)

A one station/one lamp type calling party indication panel can be provided for certain specified stations (eight stations or eight groups of stations)

The system can also be divided into a maximum of 8 groups of stations (consecutive station numbers) so that each group may have the calling party indication panels which are common within the group. The party making the call is indicated even if the call is made to any station in the group.

Indication panel at station No. 239

○ 200	● 208	○ 216	○ 320
● 201	○ 209	○ 217	○ 321
○ 202	○ 210	○ 218	○ 322
○ 203	○ 211	○ 219	○ 323
○ 204	○ 212	○ 220	○ 324
● 205	○ 213	○ 221	○ 325
○ 206	○ 214	○ 222	○ 326
○ 207	○ 215	○ 223	○ 327

<Calling station memory>

It is also possible to equip the system with the "Calling station Memory" function. Adopting this function causes the calling party's lamp on the indication panel to keep on lighting even if he cancels the call when the called party is on other line or in Privacy mode.

< Indication mode without calling station memory >

1. A lamp of the calling station comes on and goes out when the conversation is over.
2. When the call is made during conversation or privacy mode, a lamp of the calling station comes on and goes out when the calling station cancels the call.

< Indication mode with calling station memory >

1. The lamp at the station receiving the call comes on when a call is made and goes out when the conversation is completed.
2. When a call (camp-on-busy) is made to the busy or the privacy station (with the privacy switch on), the lamp of calling station comes on. The lamp will not go out even if the original call is cancelled.
3. The lamp goes out after the conversation is cancelled.
4. Dialing



without placing a call causes all lights to go out. *1

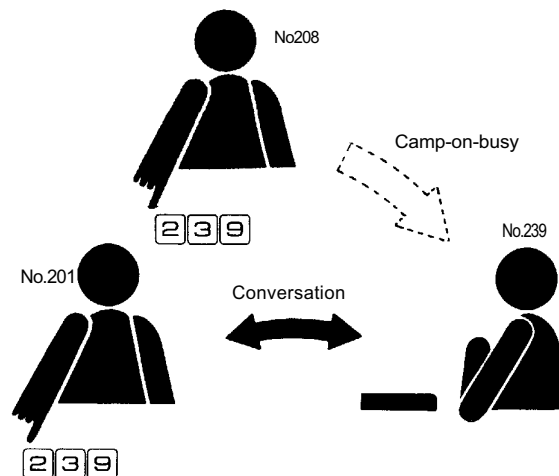

Note.

- *1. In the case of Handset Master station TL-600M, lift a station handset and confirm that a dial tone is heard. Press after cancelling the dial tone by pressing .

1. The maximum number of calling stations is 256. When 2 or 3 exchanges are connected by tie-lines, the party who is calling through the other exchange is not indicated.
2. The indication panel must be used with the Data Transmitting and Receiving Units.
3. No. 200 programming of stations or groups of stations for which a calling party indication panel is provided must be set up in exchange "A", No. 470 programming in exchange "B" and No. 740 programming in exchange "C".

Example of registration

Indication panel	First station number	Last station number
1		
2	239	239
3		
4		
5	251	255
6		
7		
8		

1. Station No. 239 has the indication panel No.2.
2. The group of stations No. 251-255 is provided with the indication panel No. 5.

< Calling party selection >

1. When there are more than 2 incoming calls to a busy station, the calling parties' lamps on the indication panel come on. The called party may select the calling party he wishes to respond to by touch dialing **[9]** plus **[XXX]** (desired calling party's number). In this event, the original conversation is finished.
2. In the event that a station in the busy mode receives a call that is indicated on the indication panel, by touch dialing **[XXX]** (the calling party's number), the called party is put through to the calling party, while the original conversation partner is placed on "hold" temporarily. (Refer to "Call Transfer" and "Call Back".)

Indication panel at station No. 239

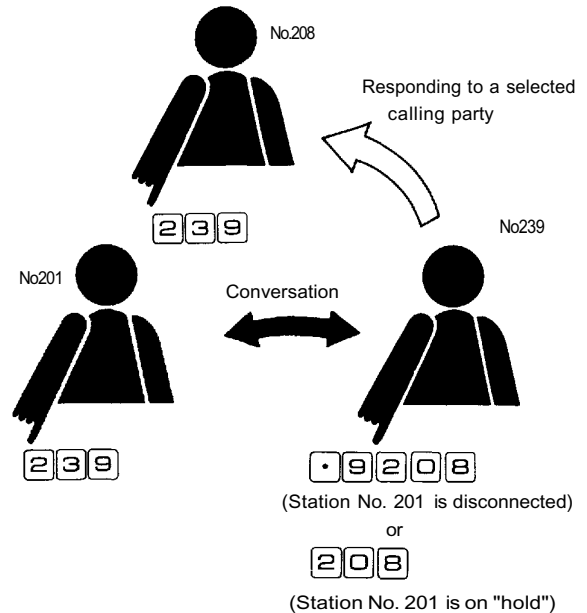
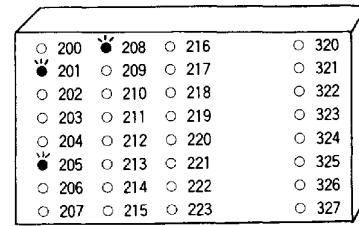

Calling Party Indication (Numerical Type)

A numerical type calling party indication panel can be provided for certain specified stations (32 stations from No. 201 to No. 232).

1. The party receiving the call is indicated in the area for the calling station number with 7 segment display.
2. When a call is made to the busy or the privacy station (with the privacy switch on), the number of the calling party is indicated in the area for the waiting station and as a 1 in the number of waiting stations area. If there are other stations waiting, the station numbers are stored but not indicated. A maximum of 8 waiting stations can be indicated. Even if a call is cancelled by a waiting station, the indication is not cancelled.
3. When a call is placed to a station in the waiting station mode, the next stored waiting station is indicated.
4. If a call is cancelled at the completion of a call, the indication is turned off.
5. To cancel a waiting station number without calling, dial **[C][C]**

to have the next station number indicated. *1

Note.

*1. In the case of Handset Master station TL-600M, lift a station handset and confirm that a dial tone is heard. Press **[C][C]** after cancelling the dial tone by pressing **[C]**

1. If the number of waiting stations exceeds 8, the indication for the station that has been waiting for the longest period of time is cancelled and the next station moves into that place.
2. The indication panel must be used with the Data Transmitting and Receiving Units. For further details, please refer to the Installation Hand Book for CP Unit and Instructions for the Data Transmitting and Receiving Units.

Indication panel at station No. 231

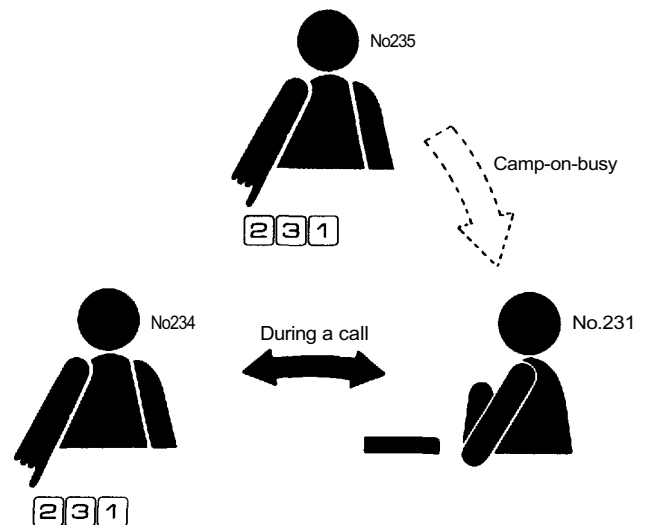
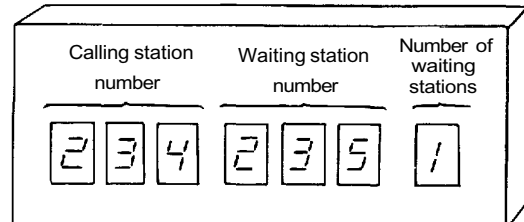

Pocket Pager

The system can be connected with usual type Pocket pager using the interface with Make/break relay output.

1. Dial

7

(00 ~ 99, Pager No.)

and the pager is called after confirmation tone is heard.

2. When

4

(00 ~ 99, Pager No.)

is dialed by the party called from the nearest master station, it is possible to respond a call to the station.

Note.

1. Once a receiver is called from one station and a response is waited for, camp-on-busy will result for other callers. But, if a response to the call is not received within 3 minutes, the terminal can be called from a new calling station.
2. If the pager is called after confirmation tone is heard, a calling station is disconnected from the speech line and waits for a response while the relay for pager transmission is kept in the Make position till a response is made. The station which waits for a response can be called from the other stations.
3. The other stations can call the other pagers while one station makes a call and is waiting for a response.
4. Dialing 4 (pager number that is called) cancels calling the pager if the wrong number has been pressed.
5. When the exchanges are connected by tie-lines, it is only possible to call the pager from the stations connected to the exchange "A" for stations No. 200 through 455. A pager response can be made from any station.

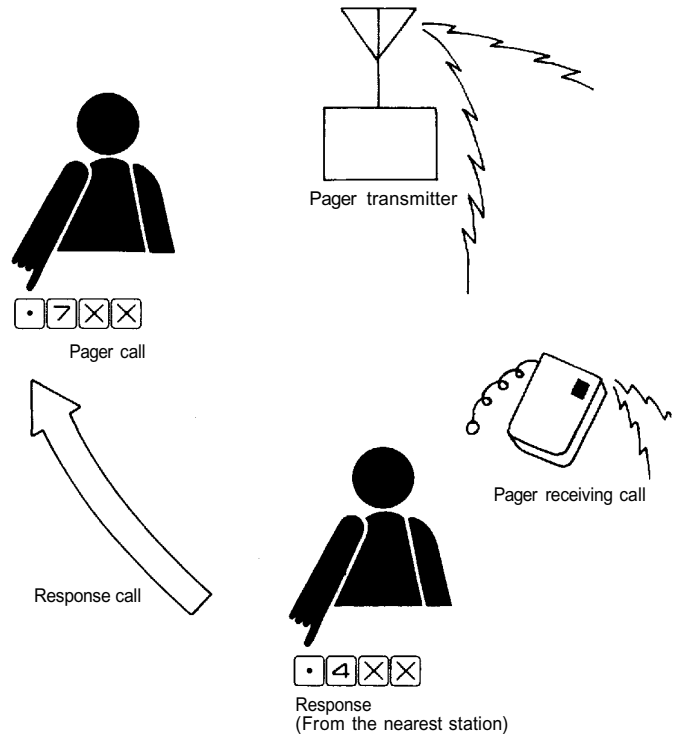

General Purpose Control

Station may be restricted from access to this function. This function can control other equipments by employing the Data Transmitting and Receiving Units.

Select the required type of output.

(Mode 1) One-shot make output (500/50 contacts)

Dial

3 (X) (X) (X)

00 ~ 49
(000 ~ 499)

and the relay output is made for 1 to 2 seconds.

Example: Door remote and VTR control

Note: Operation performed even when all link circuits are occupied.

(Mode 2) Make/break output (512/100 contacts)

Dial

3 5 (X) (X) (X)

00~99
(000 ~ 511)

and the make output is sent out.

Dial

3 6 (X) (X) (X)

00~99
(000~511)

and the break output sent out.

Example: In/out annunciation, Prescription annunciation.

(Mode 3) 8-selectable one-shot make output (9 units)

Dial

3 7 (X) (Y)

1~9 1~8
Unit No. Contact No.

and one contact out of 8 selectable make outputs is obtained for about 1 or 2 seconds.

Example: VTR control

(Mode 4) 8 selectable make output and/or decimal output

(A) 8 selectable make output (64/9 units)

Dial

3 8 (X) (X) (Y)

1~9 1~8,0 (Clear)
(01 ~ 64) Condition No.
Unit No.

and one of the 8 relay outputs is made. "Clear" operation makes all 8 relays break.

Example: Destination indication, room condition indication, ITV control

(B) Decimal output

Dial

3 8 (X) (X) (Y)

1~9 0~9
(01 ~ 64) Condition No.
Unit No.

and the condition is indicated numerically.

Example: Destination indication, room condition

(Mode 5) 4 decimal digits output

Dial

3 9 (X) (Y) (Y) (Y) (Y)

1~9 0000 ~ 9999
Unit No. 4 decimal digits

and 4 decimal digits are indicated.

Example: Prescription annunciation

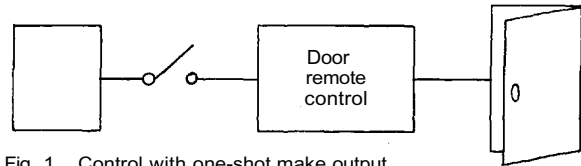

Fig. 1 Control with one-shot make output

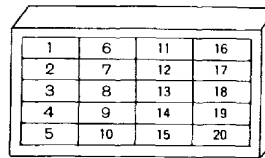

Fig. 2 Lamp on/off indication panel

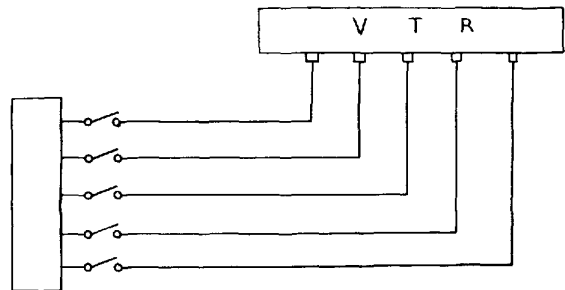

Fig. 3 VTR control with 8-selectable one-shot make output

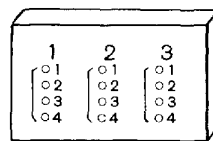

Fig. 4 8 selectable output type indication panel

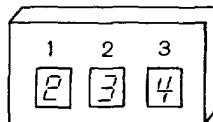

Fig. 5 Decimal output type indication panel

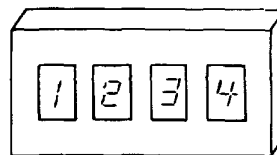

Fig. 6 4 decimal digits type indication panel

Simplified Paging

If an external speaker is connected instead of a station, simplified paging can be made without the PA amplifier if the caller dials that station number and makes a paging call.

Note.

For further details, please refer to "Installation Handbook for Exchange"

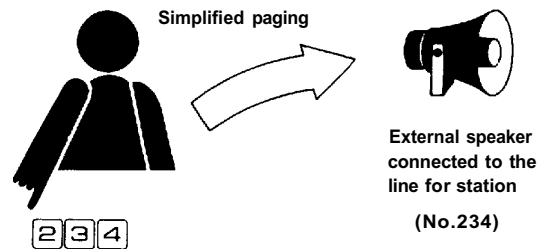

Clear Entry and Conversation Over

1. Clear entry

In the event that an error has been made when dialing for Transfer or Conference, at the start of or during the conversation, dial



This will restore the condition before the error was made, allowing the caller to make a correction without interrupting the call.

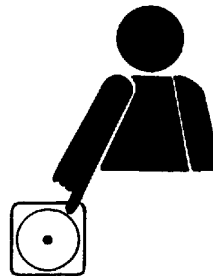

2. Conversation over

To terminate conversation, dial

 or hang up a handset

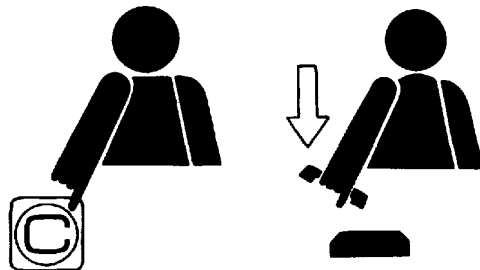

Chapter 3

Functions and operating procedures of tie-line system for a maximum of 768 stations

Volume switch
Adjusts the volume of the station speaker.

In-use Lamp
Lights up when the station is on line with another station.

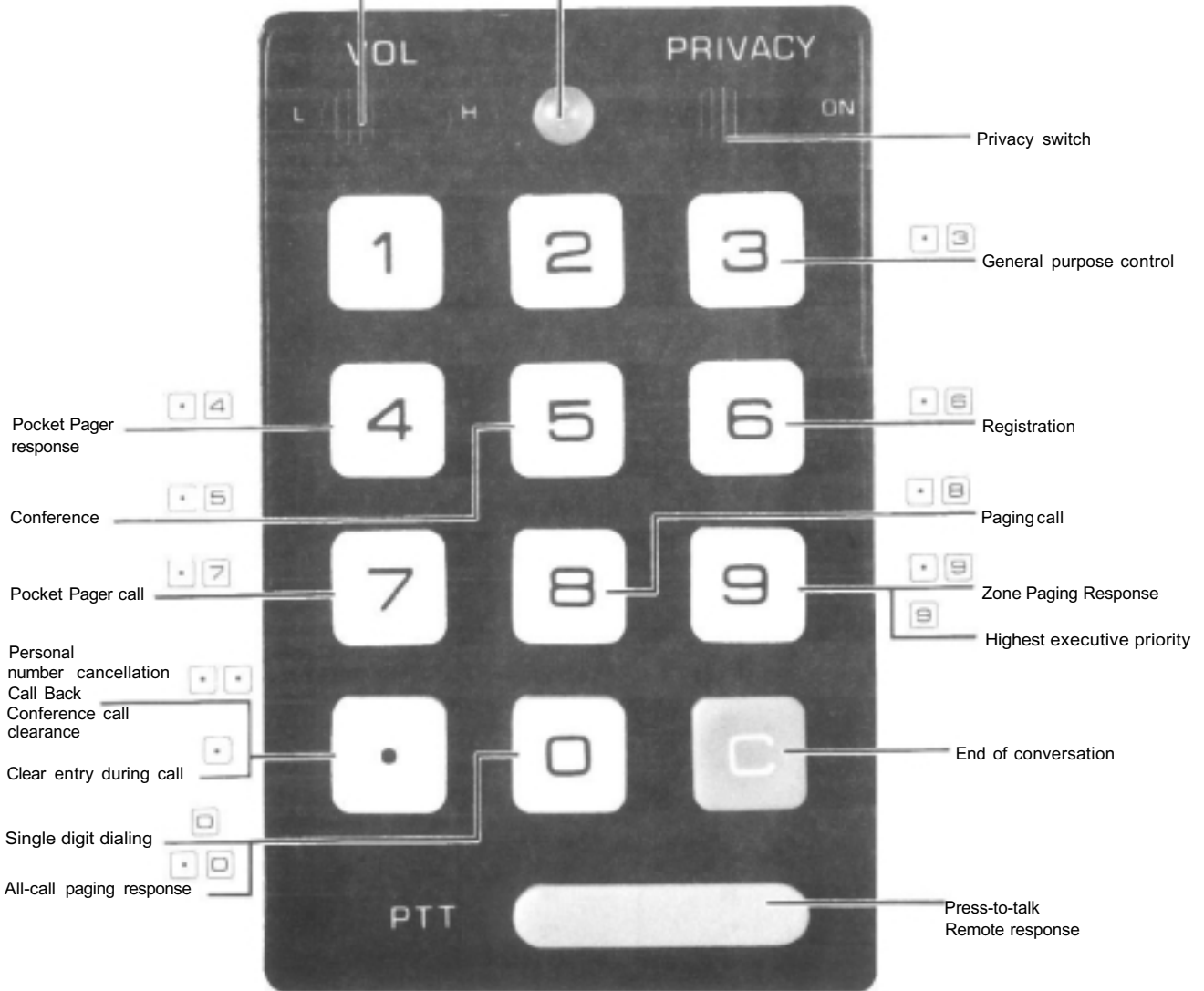

1. Purpose of tie-line connection

When the EXES-6000 system uses the Central Processing Unit Model CP-64, not only the use of a single exchange (up to 256 stations) but also the tie-line connections of 2 exchanges (up to 512 stations) or 3 exchanges (up to 768 stations) are possible.

This tie-line function may be used when

- 1) You wish to connect 2 or 3 exchanges in the remote areas (maximum distance connected between exchanges using the cable of 0.65mm diameter is approximately 2 km.)
- 2) One exchange is not sufficient enough to cover the desired number of stations and a separate exchange is required for increase in the number of stations.

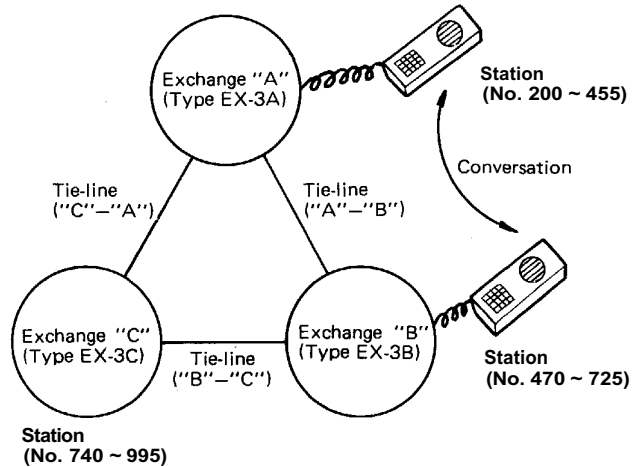
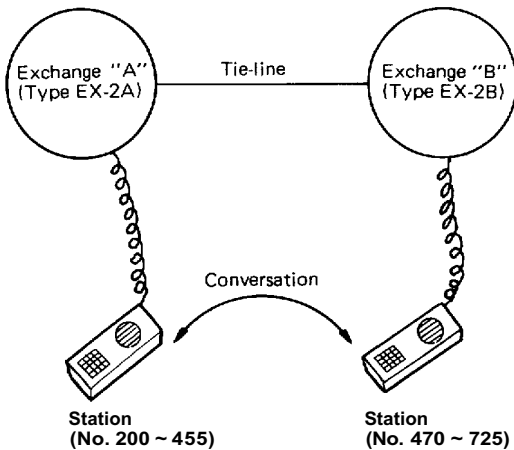

2. Number of stations, paging zones and links

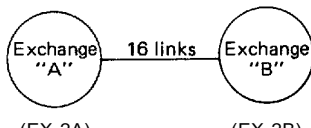
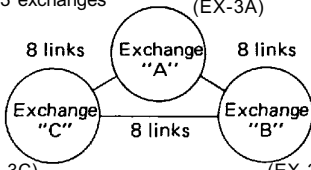
Composition of exchange(s)	Maximum number of links within own exchange	Maximum number of links between tie-lined exchanges	Maximum number of paging zones	Maximum number of stations
(1) Without tie-lines  Single Exchange (EX-1)	16	—	All call +31 zones	256
(2) 2 exchanges  Exchange "A" (EX-2A) — 16 links — Exchange "B" (EX-2B)	16 *1	16 *2	All call +30 zones *4 (15 zones per exchange)	512
(3) 3 exchanges  Exchange "A" (EX-3A) — 8 links — Exchange "B" (EX-3B) Exchange "C" (EX-3C) — 8 links — Exchange "A" (EX-3A) Exchange "C" (EX-3C) — 8 links — Exchange "B" (EX-3B)	16 *1	8 between each tie-lined link *3	All call +45 zones *4 (15 zones per exchange)	768

*1 The links within own exchange as well as the tie-line links are used in each tie-line communication.

*2 One (8 links) or two tie-line units (TI-62) are needed per exchange.

*3 Two tie-line units (TI-62) are needed per exchange.

*4 All call paging is provided to all the paging zones of all the exchanges connected by tie-line.

3. Numbering schedule for stations and paging zones

Type of exchange	Numbering for stations		Numbering for paging zones	
	Standard	Without personal number	Paging zone per exchange	
			All call	Zone
Single Exchange (EX-1)	200 ~ 455	100 ~ 355*1	0 (00)	1 ~ 9 (1 ~ 8) *2 (01 ~ 31)
Exchange "A" (EX-2A/3A)			00	01 ~ 15
Exchange "B" (EX-2B/3B)	470 ~ 725	400 ~ 655*1		16 ~ 30
Exchange "C" (EX-3C)	740 ~ 995	700 ~ 95.5 *1		31 ~ 45

Note.

* 1: The first station number of each exchange can be selected from any of the following numbers (Hardwired station number): 100/200/300/400/500/600/700/800/900.

The system with Personal Numbers can't use No. 100 ~ 199.

*2: The combination paging is used, zone number is from 1 to 8.

Besides fixed standard functions, there are selectable standard functions and optional functions. Selectable standard functions can be selected by changing over The CP Unit switches and by establishing station No. 200 programming. Optional functions can be made available by using external equipment or additional units.

1. Standard Functions

1-1. Available across the other exchange

1) Automatic Line Release

The calling Station is released from the speech path if dialing is not completed within 5 seconds. The calling station is also released from the speech path if no response is given within 10 seconds, when calling a station in the privacy mode.

2) Camp-on-Busy

When the called party is busy, the caller can camp-on the line. After the conversation is finished, he is automatically put through.

3) Press-to-Talk

One-way conversation is possible by pressing the Press-to-Talk bar when the ambient noise is high at one party's station.

4) Single Digit Dialing

Single digit calling of numbers up to 4 digits in length can be made by one-touch operation.

1-2. Available only within the same exchange

5) Remote response

The station called by continuous calling tone can be remotely answered by other stations.

2. Selectable Functions

2-1. Available across the other exchange

6) Privacy

When calls are unwanted, turn Privacy switch on and a brief privacy tone sounds when the station is called.

7) Camp-on-Privacy

When called in the privacy mode from another station, calls can be connected immediately after releasing the Privacy switch.

8) Handset Response in Continuously Called Stations

Full duplex handset conversation is available by lifting the handset when the continuous calling tone is heard.

9) One-touch Response in Continuously Called Stations

Hands-free conversation is available by just touching any key except **(PTT)** when the continuous calling tone is heard.

10) Personal Number Call

Calls can be connected by using Personal Numbers, other than normal station numbers when Personal Numbers are registered into any designated station.

11) Highest Executive Priority

The preprogrammed caller can interrupt forcibly the called party in busy mode. In this event original conversation is cancelled.

12) Selection of Dial Operation

(1) Numbering Schedules of Tie-line System (Standard)

The exchanges A, B and C permit the following standard station Numbering Schedules: (Hardwired station number)

Type of Exchange	A	B	C
With Personal Number (Standard)	200~ 455	470~ 725	740~ 995

(2) Selectable First Station Number of Each Exchange

The first station number of each exchange can be selected from any of the following numbers (Hardwired station number): 100/200/300/400/500/600/700/800/900.

The system with Personal Numbers can't use No. 100~199.

(3) Paging Response

Paging response may be made either by pressing the "Zone No.", or [Simply pressing **()**].

(4) General Purpose Control

Dial digit numbers change the output numbers.

13) Programmable Station Numbering

The system has programmable station numbers up to No. 999 other than the normal hardwired station numbers.

14) Group Blocking (Restricted Dialing)

Stations can be blocked into groups which cannot call or page each other unless further programming is done.

15) Restricted Access

Stations with access to All-call Paging, Conference and General Purpose Control can be limited.

16) Selectable Calling Tone

(Calling Tone/Paging Pre-Announcement Tone)
The time duration of the Calling Tone can be set for "long" (Trill note tone) or "short" (Single note tone) or none. Similarly, Paging Pre-Announcement Tone may be set for "long" (2 sec.) or "short" (1 sec.) or none.

17) Time-out of Conversation and Paging Call

A Calling Time Limitation can be set, in case paging and normal calls are to be kept short or where cancelling calls might be forgotten.

18) Automatic Access to Paging

Specific Substations may initiate a Paging Call or Paging Response or Personal Number Call, etc. by simply picking up a handset.

2-2. Available only within the same exchange

19) Master/Sub Relationship

Stations can call Master stations by one-touch operation. In the event of Handset Substation, a call can be made from Substation to its designated master station by simply picking up a handset.

20) Call Transfer

The called party can transfer the call to other selected station. Call Hold and Call Back are also possible.

21) Group Hunting

When the first called party in a group is busy, the call is automatically transferred to the next stations.

22) Secretary Transfer

Calls to an "Executive" may be automatically transferred to a "Secretary".

3. Optional Functions**3-1. Available across the other exchange****23) Station Paging and Response (P1-62 Unit is required)**

Paging is available through the built-in station speakers. Paging calls can be responded to by the nearest master station.

24) PA Paging and Response

(P1-62 Unit and PA System are required)
Paging through PA System and response.

25) Conference (CL-62 Unit is required)

Conference calls can be made including up to 4 persons.

26) Simplified Paging

Simplified PA paging is possible if an external speaker is connected instead of a station.

27) In/Out Annunciation

(Interface for the Indicator Board needs to be made by using Data Transmitter DT-E11 and Receiver DR-B61)

In or Out status is annunciated by registration/cancellation of Personal Numbers.

3-2. Available only within the same exchange**28) Paging during Normal Calls**

Calls can be transferred to a third party after pag while speaking.

29) Calling Party Indication [Lamp Type]

(Interface for the Indicator Board is made by using Data Transmitter DT-E11 and Receiver DR-B61)

The lamp of the calling party comes on when a call is made. The calling party is kept in display while the called party is in the privacy or busy mode. It is also possible to continue the lamp indication for the later reference for the calling party.

30) Pager Calling and Response

(Make Interface for this purpose by using Data Transmitter DT-E11 and Receiver DR-B61).

Pagers with relay input interface can be connected. A call can only be made from the stations No. 200-455 connected to the "A" type exchange. It is possible to respond from any station.

31) General Purpose Control

(Make the indicator Board and General Purpose Control Interface by using Data Transmitter DT-E11 and Receiver DR-B61)

Various types of Relay Output modes for control are available. Use as Remote Control for such applications as In/Out Annunciation, Destination Annunciation Indication, VTR and ITV.

1. Paging

- 1) Paging is possible up to a maximum number of 15 zone per exchange.
- 2) It is possible to make paging to all zones (30 zones for 2 exchanges and 45 zones for 3 exchanges) by means of All-call paging.
- 3) All-call paging and zone paging are possible from any master station.
- 4) It is possible to respond to All-call paging from any master station.
- 5) A response to the zone paging is possible only from a station connected to the exchange that includes the paged zone (Exchange "A": Zone No. 1 ~ 15, "B": No. 16 ~ 30, "C": No. 31 ~ 45). It is not impossible to respond from the station connected to the other exchange.
When the Automatic Response () is employed, the response to the zone paging is made only from the station (consecutive station numbers) linked to the paged zone.
- 6) It is impossible to allocate the same paging zone to 2 exchanges.

3. Programmable Station Numbering

It is possible to change a station number series of each exchange freely within the range of "Selectable numbering schedule of each exchange"

4. Group Blocking

- 1) The system can be grouped or divided into a maximum of 6 groups of stations by each exchange.
- 2) The group can call and/or be called by any other group(s) within the same exchange area by programming.
- 3) Only one pair of groups can call each other across the tie-lined exchange.
- 4) The group of stations which can make All-call paging and zone paging (No. 1 ~ 45) can be set up.
- 5) To make a paging response possible, the calling and the called groups must be set up. The paging response can be made from the called group to the calling group (the opposite direction of call restrictions).

5. When connected by tie-line, the following functions are available within the same exchange but unavailable across the other exchange:

- 1) Remote Response
Select the Remote response group within the stations connected to the same exchange.
- 2) Master-Sub Relationship
Set up Master/Substation associations within the same exchange area.
- 3) Transfer
An original call can be transferred only to the third party who shares the same exchange with the party who transfers the call.
- 4) Paging during Normal Calls
Paging during a normal call is only possible within the paging zones allocated to the exchange to which a station making the paging is connected.
- 5) Group Hunting
Select the station to which the call is to be transferred within the same exchange group.
- 6) Secretary Transfer
Set up a Secretary/Executive association within a group of stations connected to the same exchange.
- 7) General Purpose Control (One-shot Make Output, Make/Break Output, 8 Selectable One-shot Make Output, 8 Selectable Make Output, Decimal Output, 4 Decimal Digits Output).
Only the Data Transmitting and Receiving Units connected to the same exchange can be operated.
- 8) Calling Party Indication (Lamp type)
The lamp at the station which receives the call turns on only when the call is made from the station within the same exchange area (Max. of 256 stations). The lamp does not light if the call is made from the stations connected to the other exchange(s).
- 9) Pager Call
A call can only be made from the stations No. 200 ~ 455 connected to the "A" type exchange. It is possible to respond from any station.

EXES-6000, CP-64 Summary of Dial Operations

Tie-line

Tie-line system of 2 or 3 exchanges

Station numbering: No. 200 ~ 455, No. 470 ~ 725, No. 740 ~ 995 (standard)

Classification	Function	Dial operation	Number	Description
Call	Press-to-talk	PTT Simplex Duplex		Conversation is simplex when PTT bar is used.
	Remote response	PTT		When a station is called by continuous calling tone, near station in the groups can respond the call instead of the called station.
	Remote response registration	Confirmation tone	X X X : Station No.	Group registration of stations can be made from each station.
	Continuous calling tone response	~ , , or		Called party touches one of these keys then conversation may begin.
	Privacy	PRIVACY ON Privacy off ON		When a party does not wish to accept incoming calls, set the Privacy Switch in the ON position.
	Secretary transfer	PRIVACY ON Secretary transfer off ON		This function allows for automatic transfer of calls to a secretary when desired.
	Single digit registration	(PTT bar) Registration dials (maximum 4 digits)		This function allows for single digit registration of up to 4 digits among the numbers 0 through 9 and the key.
	Single digit dialing			Registered dial code may be automatically dialed.
	Personal number registration In/Out annunciation-lamp ON	Confirmation tone	1 X X X : 1000 ~ 1999	Personal number may be registered at any master station which the person to whom the number is assigned expects to be.
	Personal number cancellation In/Out annunciation-lamp OFF	Confirmation tone		When anyone having a personal number leaves the office he merely cancels the programming of his personal number.
	Personal number call			A personal number dialing enables the station call for a person having the personal number.
	Conference	Calling Calling	X X X : Station No., Personal No., Single digit number	A conference call may be made with up to 4 persons. Participants must be called individually.
	Conference clear			If a person called into a conference is absent, the conference may be returned to the original condition.
	Highest executive priority	Busy tone	X X X : Station No., Personal No., Single digit number	When the called party is busy, this function allows interruption of the existing conversation and immediate direct contact with the called Party.
Call transfer	Call conversation Transfer Conversation with original station		The called party can transfer the call to a selected other station (by station number, personal number or single digit number).	

Automatic Line Release

Tie-line

When, in dialing, all of the numbers are not dialed within 5 seconds, the station is automatically disconnected from the speech path and dialing cannot be completed. In this instance, the dialing process will have to be repeated from the beginning.

This function has been adopted to speed up traffic processing and to improve the availability of speech path.

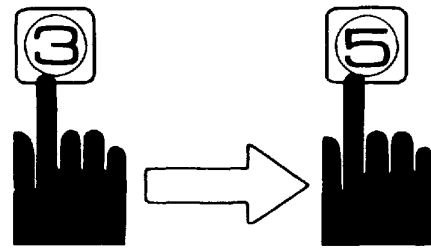

Within 5 sec

Camp-On-Busy

When the party you are calling is on another line, by simply waiting you automatically "Camp-On" the line. (Busy tone sounds continuously.) As soon as the line is freed, you will be automatically connected.

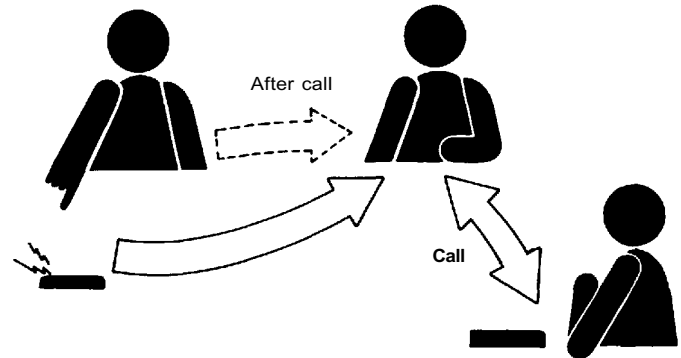

Privacy

PV Type

Shift Privacy Switch to ON.



When a party does not wish to accept incoming calls, this function may be employed to refuse them. With the Privacy switch in the ON position, a continuous privacy tone will be sounded in the station making the call, and at the same time, a brief Privacy tone will sound in the station called, indicating a call attempt is being made.

It is possible to call the other party from the station in the Privacy mode but Remote Response (PTT) is impossible from that station.

Shift Privacy Switch back to the left.



To restore a station in the "Privacy" mode to a normal condition, and thus ready to receive calls.

- Note: 1. A call received while the station is in the Privacy mode may be accepted if the Privacy function is immediately cancelled, (see Camp-On Privacy)
2. With a station that incorporates the Secretary Transfer function, the Privacy switch is used to activate the Secretary Transfer function, (see Secretary Transfer)
 3. During the above "Privacy" mode, while the calling station has the (PTT) bar depressed, the privacy tone stops and the caller can transmit a one way message.

When the (PTT) bar is released, the normal "Privacy" mode to be resumed.

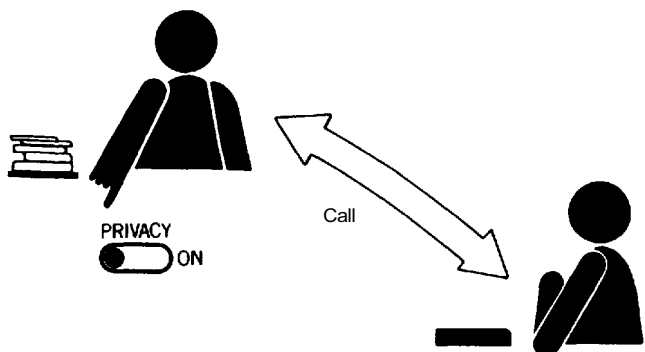
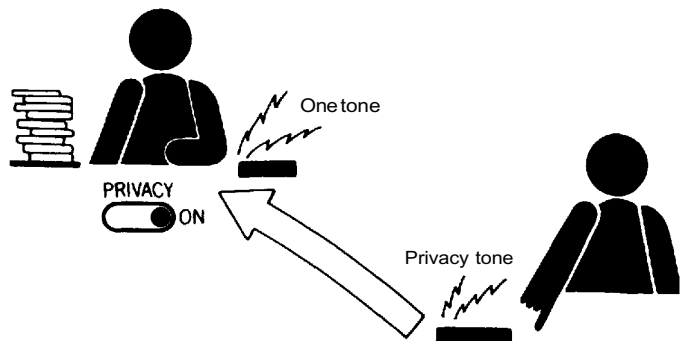

When the party you are calling has his station on Privacy mode, by simply waiting you will automatically "Camp-On" the line. (Privacy tone sounds continuously.) As soon as the Privacy mode is released, or as soon as he one-touch dials any of the keys (1~9, *, #, C), or as soon as he picks up a handset of his station, you will be automatically connected.

This function is cancelled automatically if the station in the privacy mode may not accept the call within approximately 10 seconds.

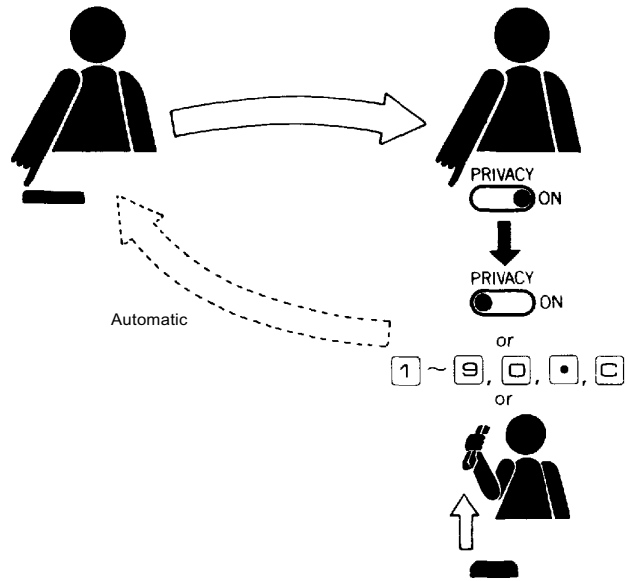

Press-To-Talk

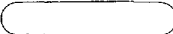
This function is activated when the PTT  (Press-To-Talk Bar)

is continuously depressed after dial tone confirmation or during hands-free conversation. This allows one-way conversation from the party depressing the function key. When the key is released, one-way conversation is reversed.

Employed when a person in a high noise level area is called by a person in a quiet area, or when no particular response is required, or when simple announcements are made. In such cases, one-way conversation flow can be used.

One-way conversation is activated while the Press-To-Talk bar is continuously depressed.

As long as the Press-To-Talk bar is depressed by either party, the voice of the party using this function has dominance. When the key is released, the other party has dominance.

One-way conversation is reversed when the Press-To-Talk bar is released.

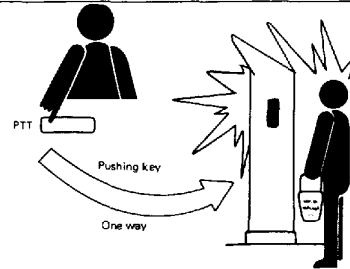

If both parties depress the Press-To-Talk bar, the voice of the party who depresses the bar last will have dominance.

Depress the



to return to ordinary hands-free 2-way conversation

Note.

One-way conversation is impossible even if the **PTT** bar is depressed as far as either party or both parties involved pick up a handset.

Single digit registration

Register in advance as follows:

• 6 0 X X X	Confirmation tone	Single digits of station number
Station number		
• 6 0 1 X X X	Confirmation tone	Single digit of personal number
Personal number		
• 6 0 • 8 X X	Confirmation tone	Single digit of paging call
Paging zone		
• 6 0 • 0	Confirmation tone	Single digit of All-call paging response
• 6 0 X X X X	Confirmation tone	
Any four digits		
• 6 0 X X X	PTT Confirmation tone	
Any three digits		
• 6 0 X X	PTT Confirmation tone	
Any two digits		

Single digit dialing

When required, dial



and the registered number will be called automatically.

Note:1. Single digit registration can be cancelled by registering your assigned station number.

2. Any function dialing with long operation may be shortened by Single Digit Dialing.

Example: Single digit Combination paging Dial 0 1, and • 8 0 1 is called automatically.

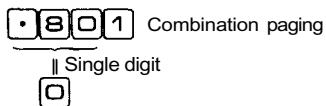

3. One-shot make output may be operated even in the event every link is not free. But it may not be operated in single digit dialing if all links are busy.
4. Single digit registration is not available from any substation programmed by No.200 programming, even if its line is connected with master station.

Master/Substation associations are set up by using station #200 as the programming station. Once these relationships have been established, substations can then contact their designated master stations by simply touch dialing



If TL-600S Handset substation is used, substations can be connected to their designated master stations by simply picking up a handset. (Only applicable to NP Type system)

With respect to this function, the stations in the system are divided into two categories; master stations and substations. Any master station can be connected to any other station in the system. However, substations can initiate calls only to specific master stations. This is done by single touch dialing, and will only connect the substation to one specific master.

Several substations can be programmed under this station to connect with a single specified master station.

To register single digit dialing, touch dial

• 6 0 X X X

substation number

Single digit dialing from that master to a specific substation is then accomplished by touch dialing

Programming a master station for Single Digit Dialing of a substation number under this function is programmed in the same manner as other single digit dialing, and results in one touch dialing from master to substation.

Note.
Single digit registration is not available from any substation programmed by No.200 programming, even if its line is connected with master station.

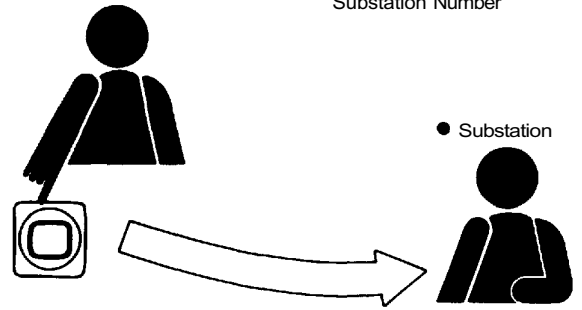
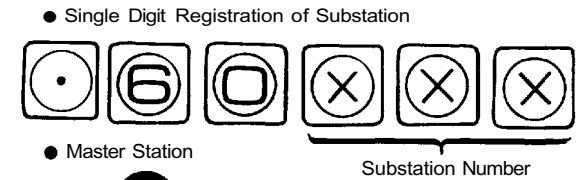
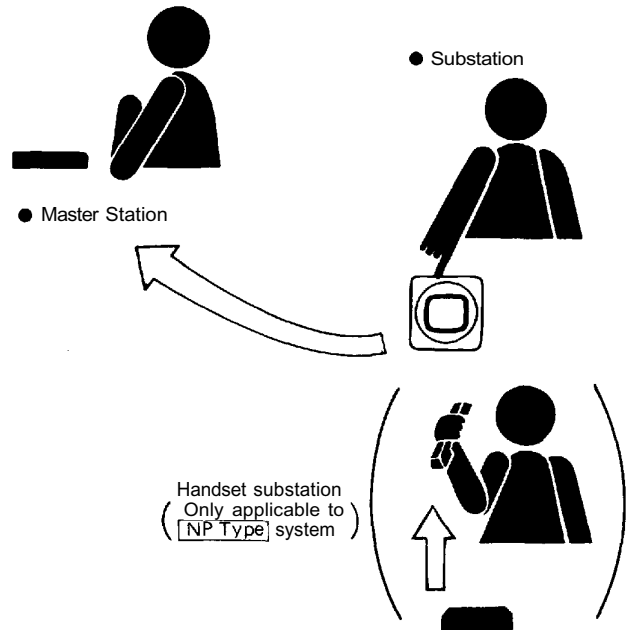

Automatic Access To Paging

Once programming has been set up for the purpose of this function.

A paging call may be made from specific Handset Substations to the registered zone by simply picking up a handset. Refer to Fig. 1

A specific Handset substations may respond to the paging call by simply picking up a handset. Refer to Fig. 2

Note.
Single digit registration for Handset Substation as well as No.200 programming is required for this function at the time of installation.

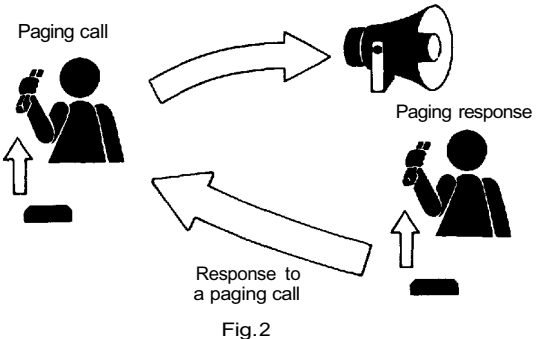
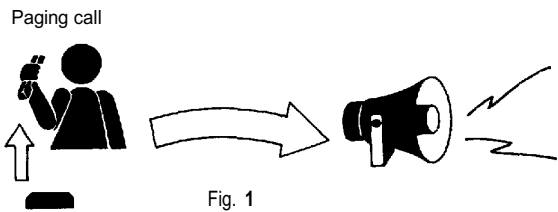

NP Type

A personal number may be registered at any master station which the person to whom the number is assigned expects to be. A party wishing to receive personal number calls at a specific station may register his number at that station by touch dialing

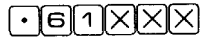

Personal Number.

Those who are frequently away from their assigned station, as well as those who share a single station may be assigned a "Personal" 4-digit number which may be programmed to any master station in the system. This personal number, which is completely independent of station numbers, may be programmed at any master station, and any previous programming of that same number at any other station is automatically cancelled. When the party calling has dialed the number to which he wishes to speak, the call is then routed to the station at which the Personal Number was last registered. The numbers which may be assigned in this group are 1000 through 1499.

Personal number program cancellation can be done at any station by merely dialing:

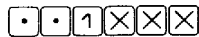

Personal Number

When anyone having a personal number leaves the office, he merely cancels the programming of his personal number. With the personal number cancelled, any incoming calls to that number will be answered by a dial tone, indicating that he is not available.

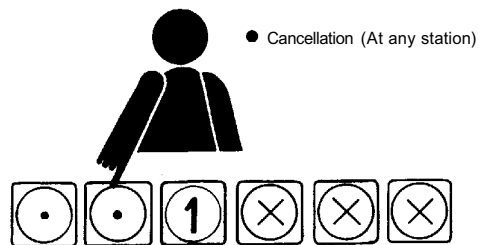
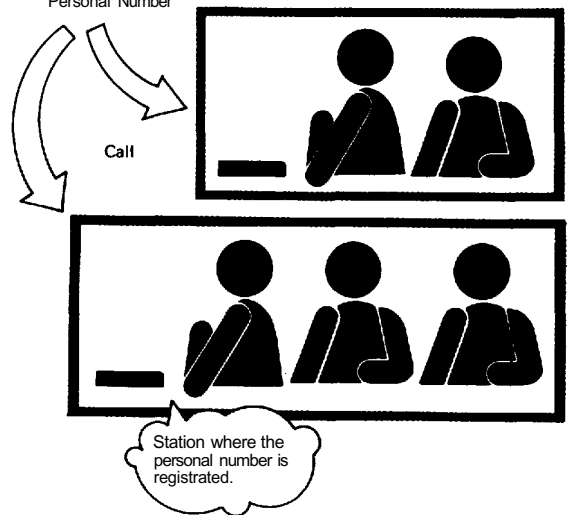
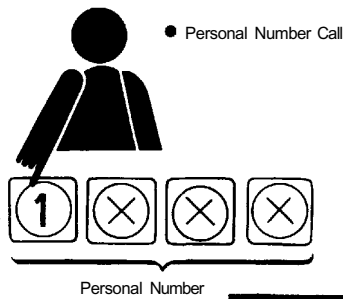
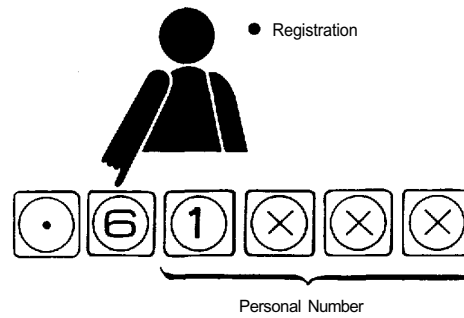

When a specified station receives a call, the calling tone continues until



is depressed by this party.

1. When calls cannot be answered immediately or when it is difficult to hear a normal calling tone due to high background noise, the station should be provided with the continuous calling tone function. There is no limit to the number of stations that may be equipped with this function, but a No.200 registration must be completed (refer to Installation Handbook for EXES-6000CP-62.)
2. When the caller depresses the PTT bar while the continuous calling tone sounds, he can talk to the person called by one-way. When the PTT bar is released, the continuous calling tone returns.
3. During two-way conversation, each party presses the PTT bar to talk and releases the PTT key to receive the other party. (Press to Talk).

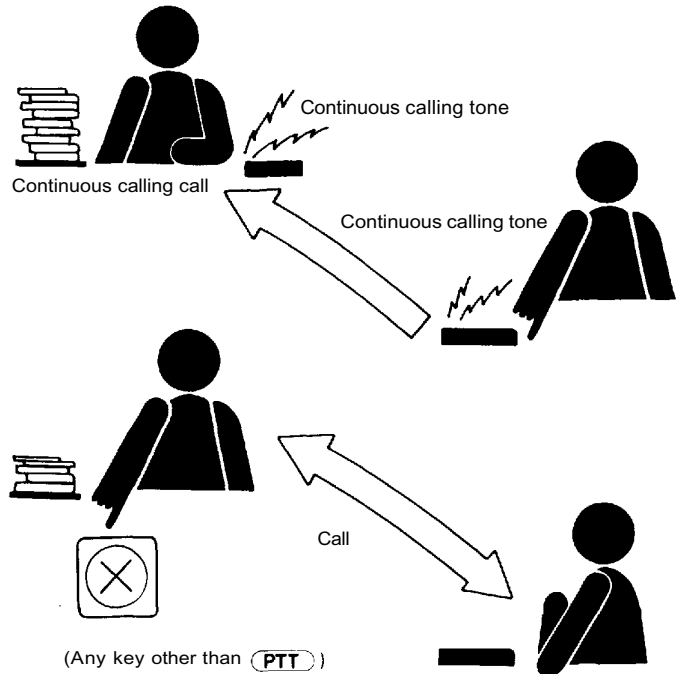

Note.

1. In the event of the system without Privacy function (NP Type system), stations with Privacy switch in the ON position are called by a continuous calling tone. By No.200 programming, this continuous calling tone function may also be made available to the system having Privacy function (PV Type system) and to industrial type of station model HF-650M.
2. Two (2) different continuous calling tones may-be employed in
 - (1) stations used in "NP" type system having a standard function of "continuous calling tone".
 - (2) specific stations provided with a "continuous calling tone" function by station No. 200 programming.

< Comparison of continuous calling tones >

Type of system	Type of station (Specific station provided with "continuous calling tone" function by station No.200 programming)	Nature of calling tone	
		Privacy switch in OFF position	Privacy switch in ON position
"PV" Type	Non-programmed station (standard)	Single "trill" calling tone (Call is put through immediately after calling tone)	Privacy tone
	Programmed station	Continuous calling tone	Privacy tone
"NP" Type	Non-programmed station (standard)	Single "trill" calling tone (Call is put through immediately after calling tone)	Continuous calling tone
	Programmed station	Continuous calling tone	Continuous calling tone
Responding to a call made by continuous calling tone		Depress any dial key other than PTT key.	1. Depress only dial key other than PTT key. 2. Pick up a handset. 3. Shift Privacy switch to OFF.

This feature is available only among stations programmed for this purpose. When a station at which no one is present is called by means of a continuous calling tone, remote response to that call can be made by pressing the **PTT** key from any other station programmed for this function.

Note.

1. This function is only possible when a station is called by a continuous calling tone.
2. When this function is used from a station with the Privacy switch ON, press the **PTT** key, after lifting a station handset or after shifting the Privacy switch to OFF.

◆ **Programming the remote response group**

Establish the remote response group of stations and designate a specific station within the group as a temporary "Master station" and the rest as "Substations".

The Master station registers the number of his own station as follows.



Each of "Substation" within the group registers the "Master" 's number by dialing



Note.

Make sure that the temporarily designated master always registers his own station number at time of programming.

◆ **Cancelling remote response program**

Touch dialing at each "Substation"

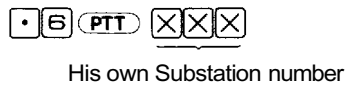

cancels the Remote response program.

Note.

When 2 or 3 exchanges are connected by tie-line, select the Remote response group within the stations connected to the same exchange.

● **Dial operation for Remote response**

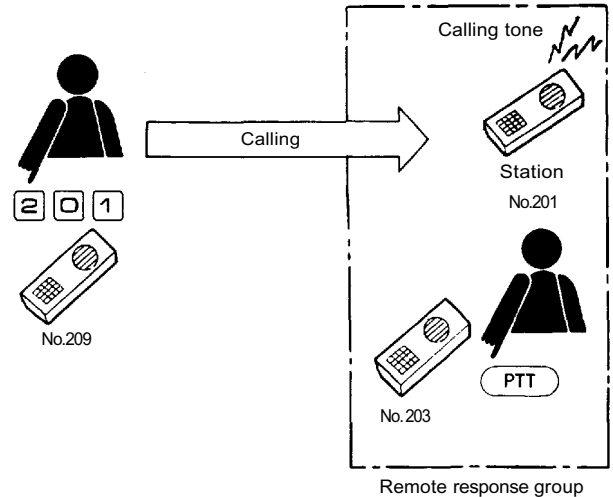

● **Conversation after Remote response**

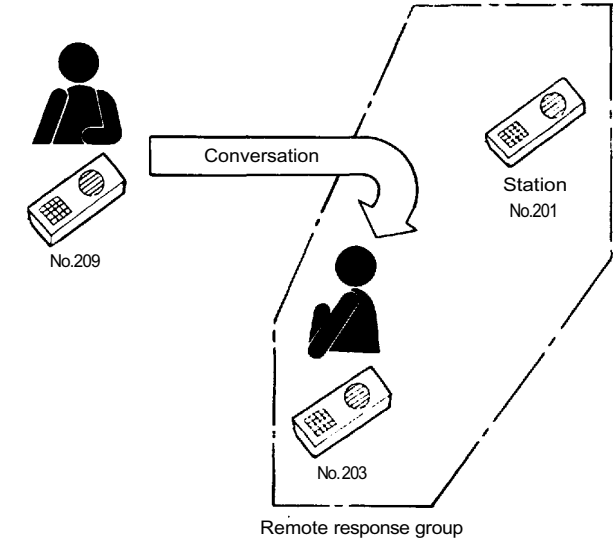

● **Programming the remote response group (Example)**

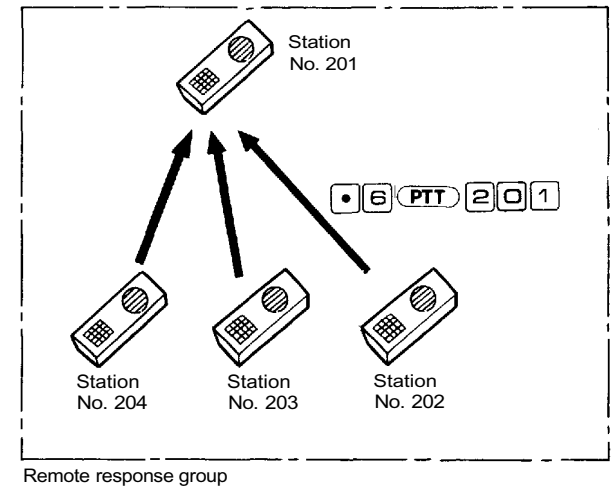

Call Transfer from Called Station

During the conversation, first dial



(the Station Number of the person the call is to be transferred to).

The original call is then held and the holding tone is transmitted to the other party, while the third party is called and asked whether he will accept the call. If he agrees to accept the call, dial

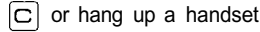

and the transfer will be completed.

This function allows called party to transfer that call to another station. The party to whom the call is to be transferred, may be called using either the Station Number, the Personal Number or through Single Digit Dialing.

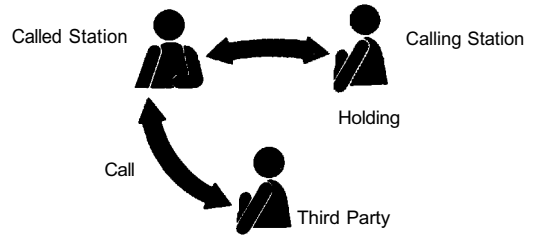
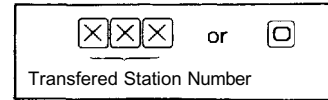
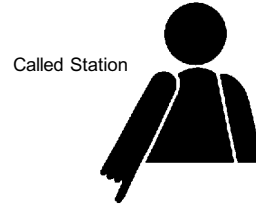
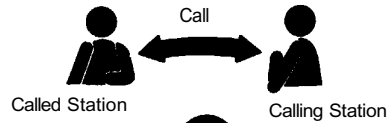

Call Hold and Call Back from Calling or Called Station

During the conversation, first dial



the Station Number of the third party.

The other party is then placed on hold as the third party is called. Upon completion of the conversation with the third party,

the party called touch dials the



key

or the third party touch dials the



key

or the third party replaces a handset.

This allows the original conversation to resume.

The Transfer function is combined with the Call Holding function.

When two parties are talking, either one can be temporarily placed on hold to permit the calling of another station. The conversation with the third party over, the original conversation can be resumed.

The third party can be called using either the Station Number, his Personal Number or through Single Digit Dialing.

● Transfer

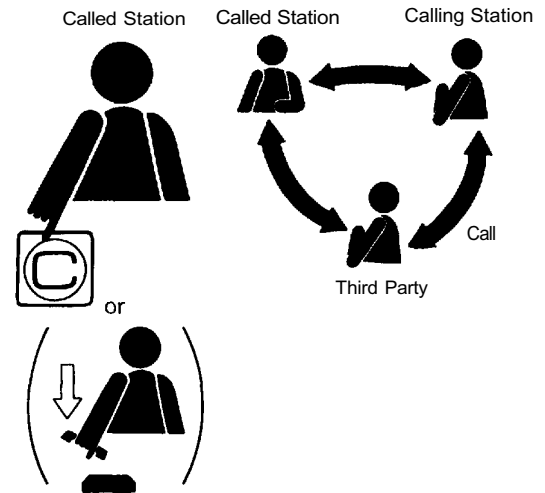



Note.

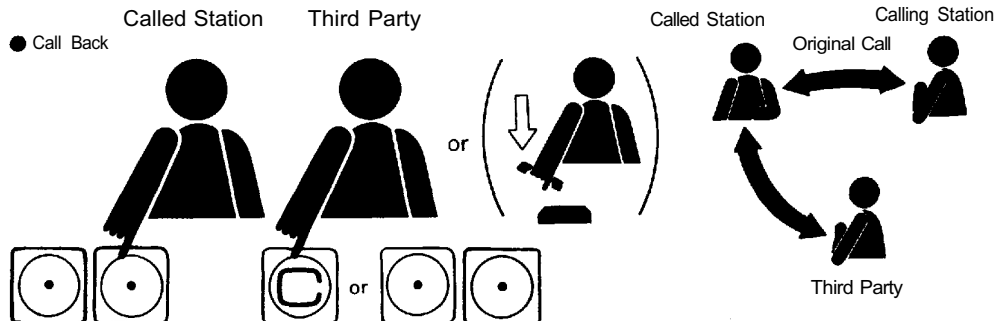

When 2 or 3 exchanges are connected by tie-line, an original call can be transferred only to the third party who shares the same exchange with the party who transfers the call.



A paging call can be made by a called party of an existing call to a third party, the third party's response accepted while the original call is on hold, and the original call resumed when the response call has ended.

Press  



and the desired zone number. This puts the original call on hold and makes the External PA and or Station paging call. Then, press

to restore the original call, and wait for the response to the paging call. When the response is received, press



or replace the handset and the original call goes back on hold allowing the second call to be taken. When the second call is completed, press

and the original call can be resumed.

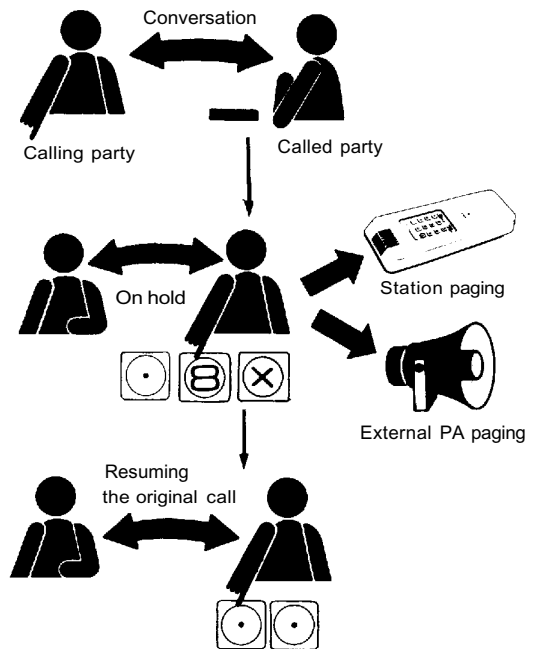

Note.

1. With adoption of the selective functions "Call Transfer" and "Paging", this function is allowed to activate.
2. When 2 or 3 exchanges are connected by tie-line, paging during a normal call is only possible within the paging zones allocated to the exchange to which a station making the paging is connected. And All-call paging during a normal call is impossible.

Group Hunting

When the party you are calling is on another line, your call is automatically rerouted to another station which is programmed from the beginning. When the party to whom the call is rerouted is also on another line, the call can further be rerouted to the other station by programming.

Note.

1. To use this function, station No.200 programming of the station number(s) to which the call is to be transferred must be set up in the exchange. Place a DIP switch for Group Hunting in the ON position and make Group Hunting programming, so that this function can be programmed.
2. The combined use of this function with the "Secretary Transfer" function makes the system more functional. When "Secretary Transfer" function is employed, setting the Privacy switch to the ON position allows any incoming call to be automatically transferred to the other stations even when one is absent.
3. If station No. 200 programming is made so that the call can be rerouted to the station which is called first when the other stations registered are busy, then any call can be transferred automatically to another station. Similarly, the original call can be rerouted one after another in the "Secretary Transfer".
4. When 2 or 3 exchanges are connected by tie-line, select the station to which the call is to be transferred within the same exchange group.

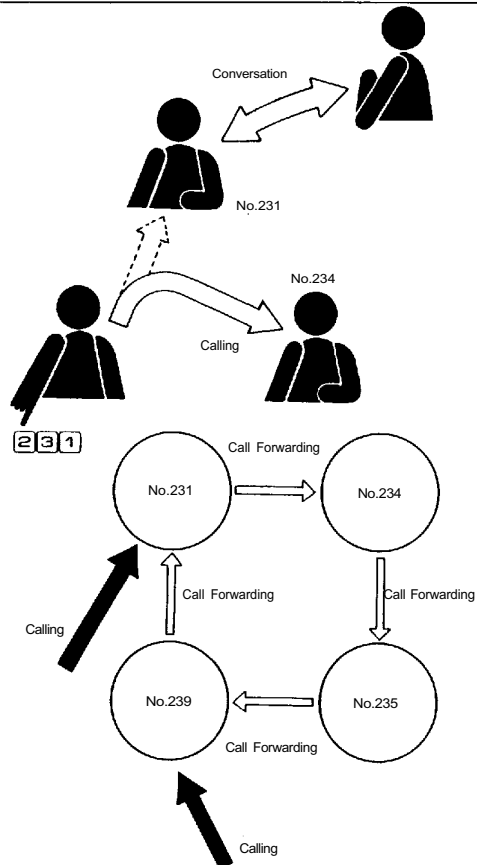

Secretary Transfer

Tie-line

This function is only available when a specified station is programmed for this purpose with use of Station #200 in the programming mode. Automatic transfer of incoming calls by an executive to his secretary is accomplished by placing the Privacy Switch on his station in the ON position.

PRIVACY ON

This function allows a secretary to accept all incoming calls placed to an executive.

For the executive to accept calls directed to his station once the automatic secretary function has been programmed by station #200, he simply moves the privacy switch to the left, or OFF position.

PRIVACY ON

It is also possible for the executive to accept calls at his station.

There is no limit to the number of Executive/Secretary pairings except by the number of available number combinations within a given system.

When a secretary who is already programmed for this function wishes another secretary to accept all incoming calls directed to an executive, station No. 200 programming of another secretary should be set up in the exchange. Then, the calls can be rerouted to another secretary if the executive and the secretary first registered place their Privacy switches in the ON position. It is also possible to transfer the call in a daisy chain method.

Note.
When 2 or 3 exchanges are connected by tie-line, set up a Secretary/Executive association within a group of stations connected to the same exchange.

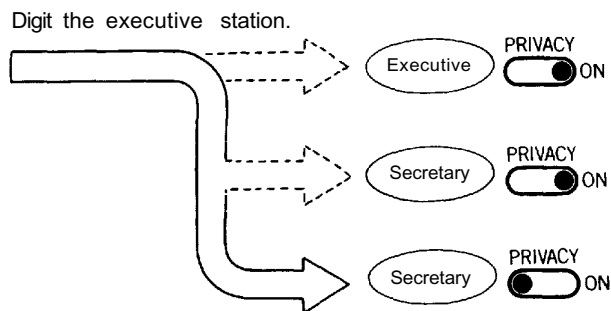
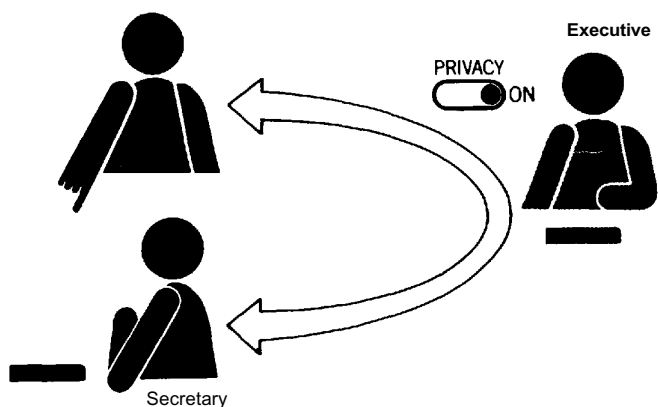

Secretary Transfer and Call Transfer

Adoption of the selective function "Transfer" allows rerouting of the call transferred to the secretary back to the executive's station.

When the secretary answering a call touch dials

Executive's station number

the privacy tone sounds continuously at both ends of the line, while the call is held. The call holding tone is transmitted to the calling station. If the executive shifts the privacy switch to the left position, or if he depresses any of the keys other than the PTT key (~, , ,) or picks up a handset he can talk with the secretary. If the call held is to then be transferred back to the executive's station, the secretary is to touch dial , or to hang up a handset, and the original calling station will be connected to the executive's station.

Secretary Transfer and Call Transfer using Single Digit Dialing

Adoption of the selective functions "Transfer" and "Single Digit Dialing" allows simple retransfer of the call transferred to the secretary back to the executive's station.

Touch dial

Executive's station number

at the secretary's station in advance. When the call transferred to the secretary has to be transferred back to the executive, the secretary simply touch dials

at her station. This sets the privacy tone sounding continuously at both ends of the line while the call is held. If the call is to be transferred back to the executive's station, the secretary touch dials or hangs up a handset.

The calling station will then be connected to the executive's station.

Reply from the executive, the secretary touch dials

This will then return the secretary to the original call.

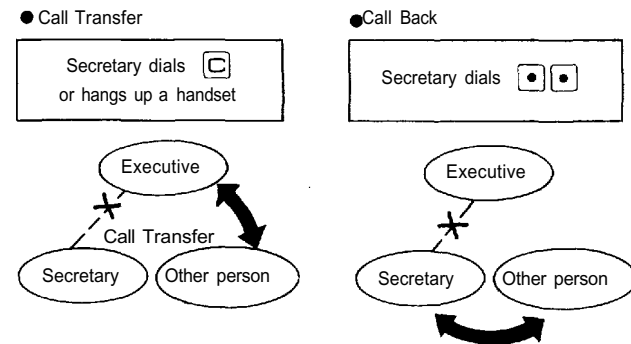
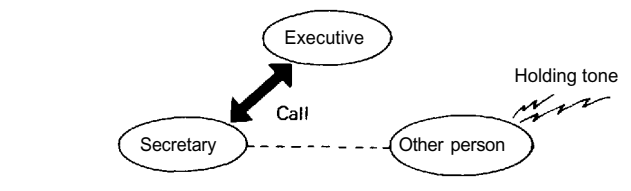
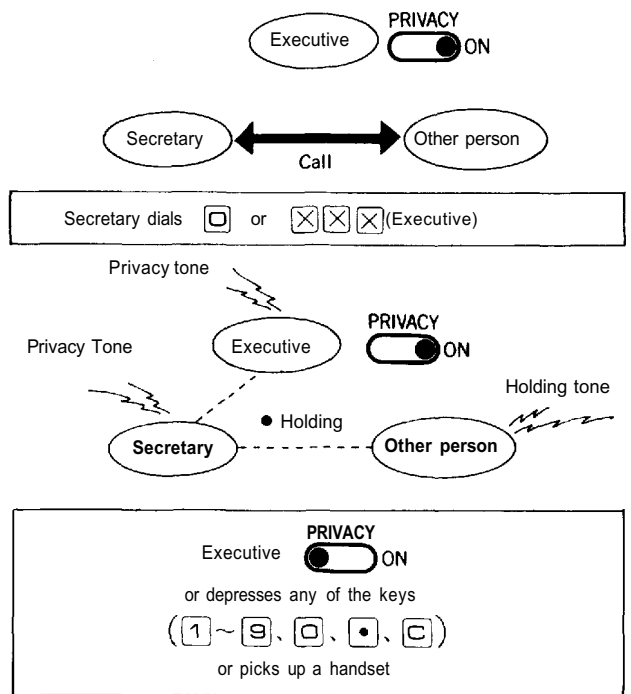

Secretary Transfer and Call Transfer

Adoption of the selective function "Transfer" allows rerouting of the call transferred to the secretary back to the executive's station.

When the secretary answering a call touch dials **XXXX**
 Executive's station number
 the continuous calling tone sounds at both ends of the line, while the call is held. The call holding tone is transmitted to the calling station. If the executive shifts the privacy switch to the left position, or if he depresses any of the keys other than the **PTT** key (**0-9**, **0**, *****, **C**), or picks up a handset he can talk with the secretary. If the call held is to then be transferred back to the executive's station, the secretary is to touch dial **0**, or to hang up a handset, and the original calling station will be connected to the executive's station.

Secretary Transfer and Call Transfer using Single Digit Dialing

Adoption of the selective functions "Transfer" and "Single Digit Dialing" allows simple retransfer of the call transferred to the secretary back to the executive's station.

Touch dial **060XXXX**
 Executive's station number
 at the secretary's station in advance. When the call transferred to the secretary has to be transferred back to the executive, the secretary simply touch dials **0**
 at her station. This sets the continuous calling tone sounding at both ends of the line while the call is held. If the call is to be transferred back to the executive's station, the secretary touch dials **C** or hangs up a handset.
 The calling station will then be connected to the executive's station.
 Reply from the executive, the secretary touch dials **00**
 This will then return the secretary to the original call.

Executive **PRIVACY ON**

Secretary **← Call →** Other person

Secretary dials or **XXXX** (Executive)

Continuous calling tone

Continuous calling tone Executive **PRIVACY ON** Holding tone Other person

Executive **PRIVACY ON**
 or depresses any of the keys **(1-9, 0, *, C)**
 or picks up a handset

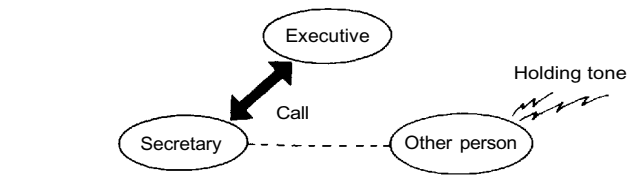

● Call Transfer

Secretary dials **C** or hangs up a handset

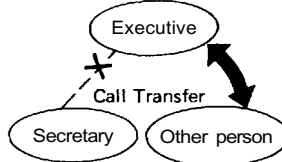

● Call Back

Secretary dials *****

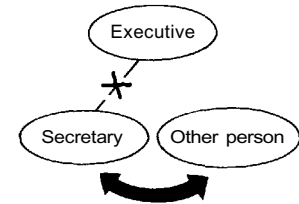

This function is available only for those stations specifically programmed for this function, with programming station No. 200. When the station called is busy, as indicated by the busy or privacy tone, dialing



sends a priority tone. This priority tone is transmitted for a few seconds and then the call is put through, terminating the original conversation.

When the called station is busy or in the Conference mode or during a paging call, this function allows forced interruption for priority conversation.

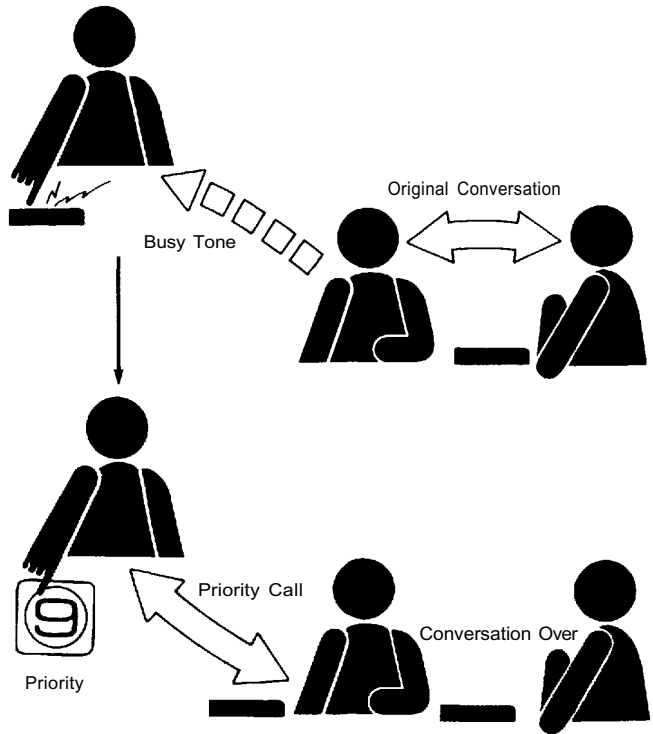

A "Hands-Free" conference call can be made with up to 4 persons. For a conference under this function the other participants may be called either through their station number, personal number or by Single Digit Dialing. Addition of stations or personal numbers (total of only 4) may be added by anyone already connected.

The person who proposes the conference may dial
 • 5 X X X X
 (Station Number of the 1st of the participants)
 After receiving 2nd person's consent, he may then dial
 X X X
 (2nd participant)
 After receiving 3rd person's consent, he may now dial
 X X X
 (the last participant)

At this point, the 4-man conference may begin. It is also possible for any of the 4 participants to call up any of the other participants.

A person wishing to drop out of the conference should dial
 C or hangs up a handset
 at his station.

Any of the participants who wish to drop out during the conference may do so as long as it's not the party who originated the conference.

The function is cancelled and the normal mode is restored when the person who arranged the conference dials
 • •

In the event that the calls made by the person arranging the conference are not answered or that there has been a dialing error, the function can be cancelled for restoration to the normal mode.

The conference is terminated when the party who arranged the conference dials
 C or hangs up a handset

When the conference has been terminated by the party who originated it, the other participants cannot continue the conference.

- A "Hands-Free" conference call can be made with up to 4 persons.

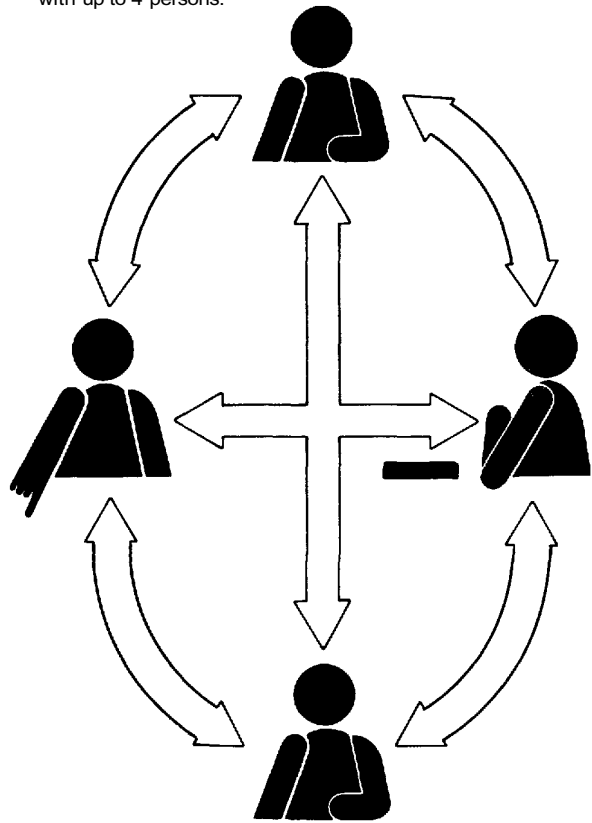

- Dialing of conference member.

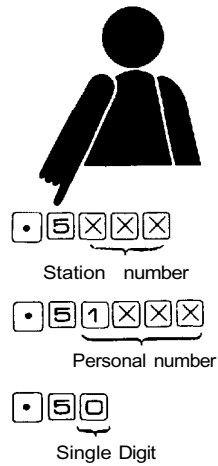

A variety of paging modes allows paging over a wide area from any master station. The paged party may respond from the nearest master station.

Paging modes include external PA systems and/or Station paging, and Zone paging is for calling a limited area and All-call paging is for calling over the entire area.

Response to a paging call may be made by means of Automatic response or Zone number dialing.

1. External PA paging and Station paging

A. External PA paging

1. Paging through external speakers is possible from any master station, with the paged party able to respond from the nearest master station.
2. External PA paging zones and all-call paging are possible up to a maximum number of 15 zones per exchange.
3. A maximum of 30 zones can be connected when 2 exchanges are tie-lined and 45 zones for 3 exchanges.

B. Station paging

1. Paging from any master station to all stations within a certain area is possible through the station speakers. But the page will not be heard at stations in use in the area.
2. Zone paging and all-call paging are possible up to a maximum number of 15 zones per exchange.
3. A maximum of 30 zones can be connected when 2 exchanges are tie-lined and 45 zones for 3 exchanges.

2. Zone paging and All-call paging

A. Zone paging (Individual zone paging).

Paging and Paging response are possible through Zone paging. The same paging zones (Exchange A: No. 1 ~ 15, B: No. 16 ~ 30, C: No. 31 ~ 45) are used for PA paging and Station paging. Therefore, both PA and Station paging calls are possible in the specific zone connected for the both paging functions.

To page, depress

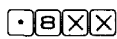

Zone No. (01 ~ 45)

To respond to a zone paging, depress



Zone No. (01 ~ 45)

B. All-call paging

Paging and Paging response for External PA or station paging is possible through All-call paging. All-call paging is possible over the zones (No. 1 through 45) connected for PA or Station paging, and it is possible to make the paging response from any station. However, the station not connected to any of the paging zones is not paged. This does not necessarily mean that All-call station paging must reach all the stations.

To make a all-call paging, depress



To respond, depress



3. Responding to a paging call

A. Automatic response

1. Zone paging response
Touch dialing



at the station within the paged zone permits a response to the party who placed a paging call. In this event, No. 200 registration of the stations (consecutive station numbers) within each zone must be made.

2. All-call paging response
Touch dial



at any station and the paged party is put through to the party calling.

B. Zone number dialing

1. Zone paging response
The paged party is connected to the party calling by depressing



Zone No. (01 ~ 45)

at any station.

A response to the zone paging is possible only from a station connected to the exchange that includes the paged zone.

2. All-call paging response
Depressing



permits a response to the party calling.

Paging area	No.	Dialing operation		
		Paging call	Response	
			Automatic response	Zone number dialing
All-call paging over the entire zones of exchanges "A", "B" and "C" *1	0	• 8 0 0	• 0 or • 9 0 0	
Zone paging to the zone of exchange "A" 1 } 15		• 8 X X Zone No. (01 ~ 15)	• 9 X X Zone No. (01 ~ 15) *3	
Zone paging to the zone of exchange "B" 16 } 30		• 8 X X Zone No. (16 ~ 30)	• 9 X X Zone No. (16 ~ 30) *4	
Zone paging to the zone of exchange "C" 31 } 45		• 8 X X Zone No. (31 ~ 45)	• 9 X X Zone No. (31 ~ 45) *5	

Note.

- *1 When 2 or 3 exchanges are connected by tie-line but 1 or 2 of them have no built-in Paging unit (PI), All-call paging is done only over the remaining exchange(s).
- *2 A paging response is possible only from the station in the paged zone.
- *3 A paging response is possible only from the station connected to the exchange "A" (station No.200 ~ 455)
- *4 A paging response is possible only from the station connected to the exchange "B" (station No.470~ 725)
- *5 A paging response is possible only from the station connected to the exchange "C" (station No.740~ 995)

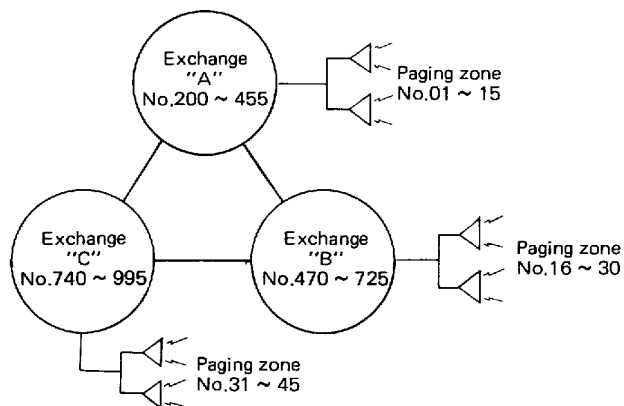

◆ Paging call

External PA paging to a specific zone is possible from any master station by pressing after picking up a handset.

("00" = all-call)
 (00 ~ 45)

It is possible to wait for a response in this mode, but anything said will be broadcasted over the entire zone. It is best to end the paging call by pressing

or hanging up a handset

and waiting for a response.

All-call paging of zones 1 through 45 can be done in both the External PA paging mode through an external amplifiers and speakers, and the station paging mode through the station speakers. In the event of All-call paging, the paging is done over the entire zones.

When all-call paging is initiated during zone paging, the Zone paging is interrupted and restored after the all-call paging is finished.

◆ Paging response

1. Automatic response

To respond to a paging call, go to the nearest master station and press either

(All-call paging response)
 or
 (Zone paging response)

A paging response is possible only from the station in the paged zone.

A response to All-call paging is possible from any station.

To respond to Zone paging by pressing , No. 200 registration of the stations (consecutive station numbers) within each zone must be made. Such registration is required for both external and station paging.

2. Zone number dialing

To respond to a All-call paging, go to the nearest master station and press

or

To respond to a Zone paging call, press

Zone No. 01 ~ 45

at the nearest station.

A response to the zone paging is possible only from a station connected to the exchange that includes the paged zone (Exchange "A": Zone No. 1 ~ 15, "B": No. 16 ~ 30, "C": No. 31 ~ 45). It is not impossible to respond from the station connected to the other exchange.

A response to All-call paging is possible from any station.

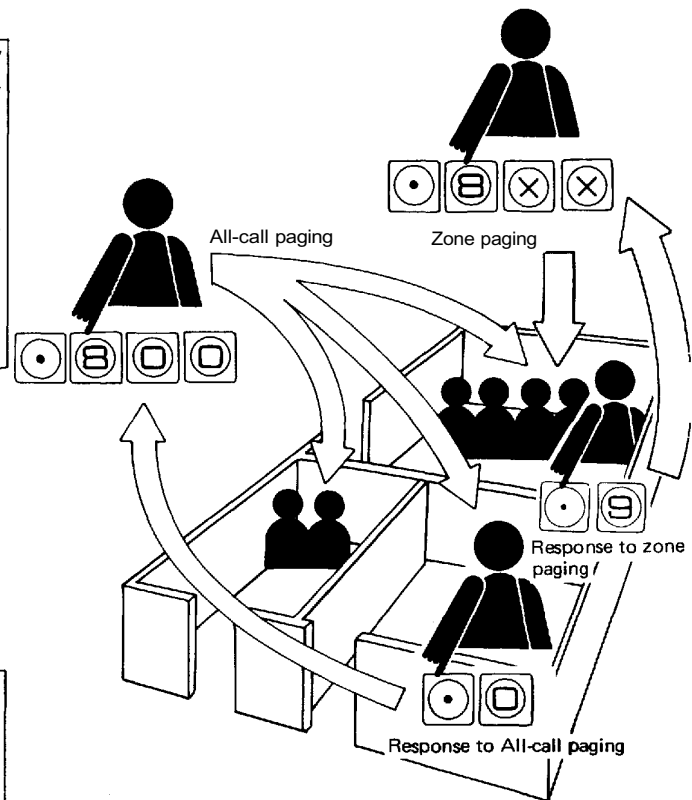

Table of stations used for individual zone paging (Example) (In the case of "Automatic response")

	Zone numbers	First station number	Last station number
Exchange A	1	2 0 1	2 0 3
	2	2 0 5	2 0 7
	3	2 1 0	2 1 9
Exchange B	4		
	14		
	15		
	16		
	17		
	18		
Exchange C	19		
	29		
	30		
	31		
	32		
	33		
	34		
	44		
	45		

Selectable First Station Number of Each Exchange

Tie-line

1. The exchanges A, B and C permit the following Standard Station Numbering Schedules (Hardwired station number):

< Standard station numbering >

Type of Exchange	A	B	C
With Personal Number (Standard)	200 ~ 455	470 ~ 725	740 ~ 995

2. If you prefer any other station numbering schedules than those given in the above Item 1, you can have the station number series (Consecutive number) to start with any of No. 100/200/300/400/500/600/700/800/900 in the order of exchange A, B and C. (Hardwired station number)

< Example >

Type of Exchange		A	B	C
Example 1	With Personal Number	<u>3</u> 00 ~	<u>5</u> 00 ~	<u>7</u> 00 ~
Example 2	Without Personal Number	<u>1</u> 00 ~	<u>6</u> 00 ~	<u>9</u> 00 ~

- This function allows the system to have "Programmable station numbers", other than the "Hardwired station numbers" by programming. The stations not registered for "Programmable Station Numbers" remain in the original "Hardwired Station Number".
- Each station number can be programmed in the station number series of the exchanges A, B and C that have been determined by the function of the Selectable First Station Number.

- Numbering schedules can be changed easily by programming in stead of rewiring.
- Numbering schedule (such as 200's, 300's, 900's) is available for convenient office differentiation. (architectural numbering). (Refer to Fig. 1)

<Fig. 1>

Hardwired station number	Programmed station number
2 0 1	2 0 1
2 0 2	2 0 2
2 0 3	
2 0 4	3 0 1
2 0 5	3 0 2

} Department 1
} Department 2

- Normally, station numbers which are included in a station paging zone must be sequential, but programmable station numbers can be randomly included in a station paging zone. (Refer to Fig. 2)

<Fig. 2>

Hardwired station number	Programmed station number
2 0 1	2 0 1
2 0 2	2 3 1
2 0 3	2 4 1

} Station paging zone

- Programming at station No. 200, 470 and 740 must set up in each exchange to change the station numbering.

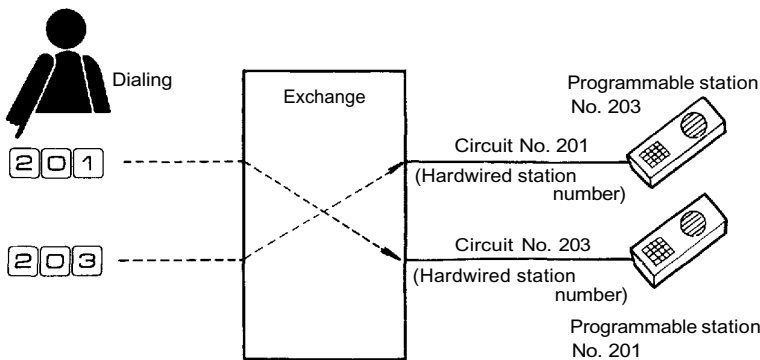

<Fig. 3>

Hardwired station number	Programmed station number
2 0 0	→
2 0 1	2 0 3
2 0 2	→
2 0 3	2 0 1
3 2 6	→
3 2 7	→

- "Programmable station number" series for each exchange

<Example 1> With Personal Number

Exchange	Hardwired station number	Programmed station number
A	200 ~ 455	200 ~ 469
B	470 ~ 725	470 ~ 739
C	740 ~ 995	740 ~ 999

<Example 2> Without Personal Number

Exchange	Hardwired station number	Programmed station number
A	100 ~ 355	100 ~ 399
B	400 ~ 655	400 ~ 699
C	700 ~ 955	700 ~ 999

<Example 3>

Exchange	Hardwired station number	Programmed station number
A	200 ~ 399	200 ~ 499
B	500 ~ 755	500 ~ 799
C	800 ~ 999	800 ~ 999

(Standard)

- People operating the intercom stations need not be aware of the Hardwired station numbers. However, care must be taken when programming using station No. 200 in the exchange, as hardwired station numbers must be used for that purpose.

Function (A)

The system can be grouped or divided into a maximum of 6 groups of stations with consecutive station numbers by exchanges "A", "B" and "C". Different station groups cannot call each another.

[Example 1]

< Exchange "A" >

Fig. 1

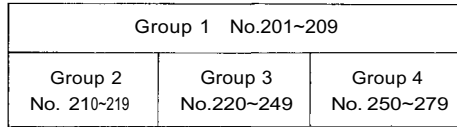

< Exchange "B" >

Fig. 2

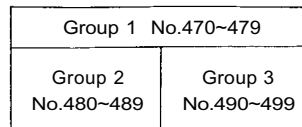

< Exchange "C" >

Fig. 3

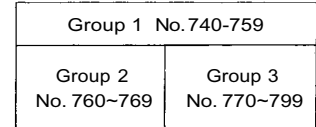

Function (B)-1

The group connected to the same exchange can call and/or be called by any other group(s) within the same exchange area.

[Example 2-1] Fig. 4

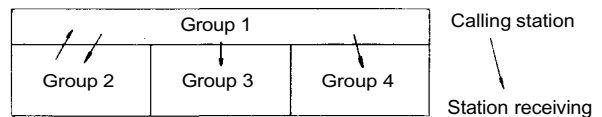

Function (B)-2

Only one pair of groups can call each other across the tie-lined exchange. The tie-line link of each exchange (4 links) forms a group (T_L and T_H) like stations. The groups No.1 through 6 connected to the same exchange can call exchange by programming in tie-line links T_L (group No. 7) and T_H (group No. 8).

[Example 2-2]

< 2 exchanges tie-lined > Fig. 5

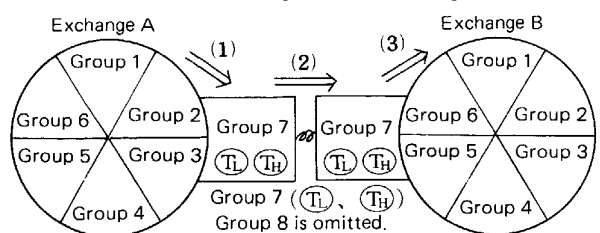

< 3 exchanges tie-lined > Fig. 6

Explanation of < 3 exchanges tie-lined > (Fig. 6)

- 1) The call can be made from Group No. 2 of exchange "A" to tie-line links T_L of exchange "A". (1)
- 2) Connect tie-line links T_L of exchange "A" to tie-line links T_H of exchange "B". (2)
- 3) The call can be made from tie-line links T_H of exchange "B" to group No. 1 of exchange "B". (3)
- 4) Thus, the call is allowed to go through from Group No.2 of exchange "A" to Group No. 1 of exchange "B".

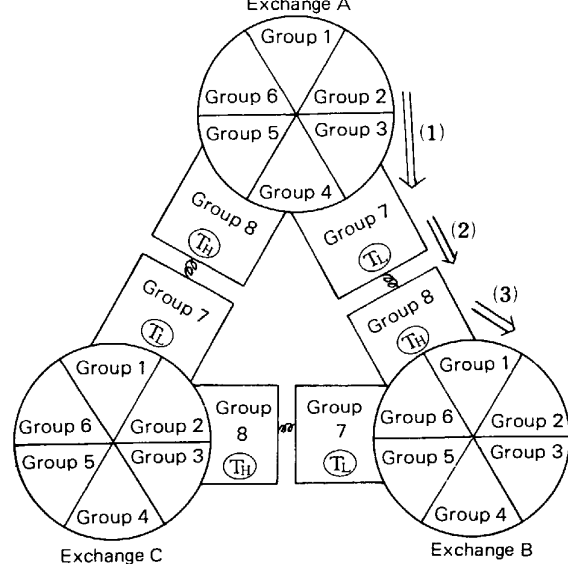

Function (C)

The paging zone number (All-call, individual zones No.1 ~ 30 for 2 exchanges and No.1 ~ 45 for 3 exchanges) which each group of each exchange can call is programmable. (No distinction is made between external PA and Station paging.) Paging to the paging zones of the other exchange is also programmable.

Note.

When the paging call is made, the group of stations to which the response is made is restricted by Function B. Function B permits the normal station call in the direction of the arrows. Its paging response can be made in the opposite direction of the arrows. (Refer to Fig. 4 and Fig. 8)

< Example of Paging response >

When the programming is set up for the normal station call as is shown in Fig. 4, the paging response is only possible in the direction of the arrows of Fig. 8.

[Example 3] Fig. 7

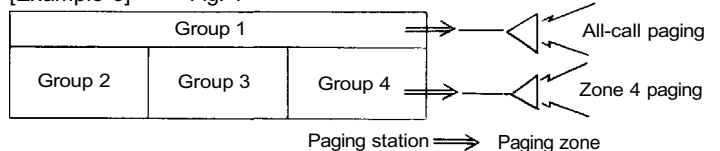

[Example 4] Fig. 8

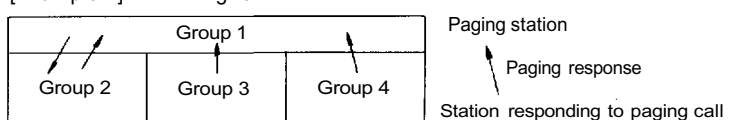

Example of Group Blocking registration

Tie-line

To use this function, station No. 200 programming (No.470 programming or No.740 programming) of the allocated station number, group, paging zone, etc., must be set up in the exchange.

1. Example of conversation and paging
To make this example of Group Blocking available for the system, the following programming at steps 2 through 4 must be set up in each exchange.

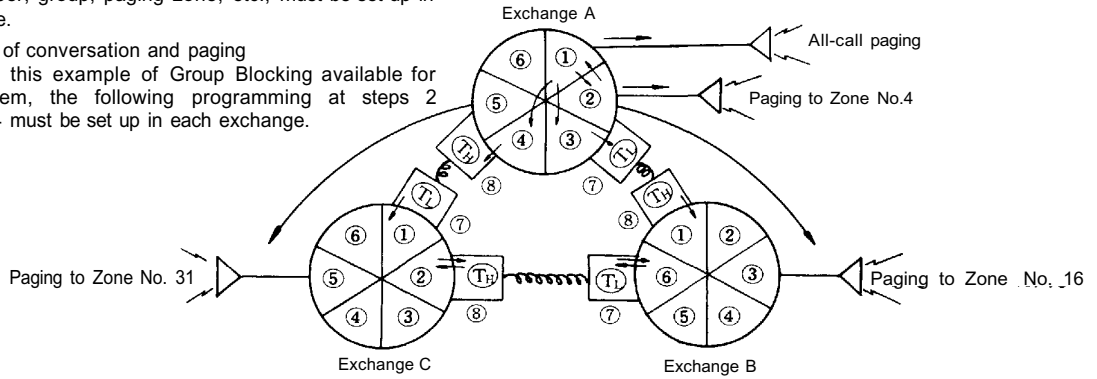

2. No. 200 programming" in Exchange A

Station for each group		Group No. of calling station		Group No. of station receiving call								Paging zone of station receiving call																			
												All-call																Zone No.			
First station No.	Last station No.	1	2	3	4	5	6	7	8	X	00	01	02	03	04	14	15	16	17	18	19	29	30	31	32	33	34	44	45		
2 0 1	2 0 9	⊙																													
2 1 0	2 1 9	⊙	⊙																												
2 2 0	2 4 9		⊙																												
2 5 0	2 7 9			⊙																											
					⊙																										
						⊙																									
							⊙																								
								⊙																							
									⊙																						
																					</										

Stations which can use the 6 groups of following functions must be programmed, so as to restrict access to those functions by those stations not programmed.

1. All-call paging
 8 0 0

2. Conference
 5 X X X
 Station number

3. General purpose control
 Mode 1 (One-shot make output)
 3 (X) X X
 00 ~ 49
 000 ~ 499

4. General purpose control
 Mode 2 (Make/break output)
 3 5 (X) X X
 00 ~ 99
 000 ~ 511
 3 6 (X) X X
 00 ~ 99
 000 ~ 511

5. General purpose control
 Mode 3 (8 selectable one-shot make output)
 3 7 X Y
 1 ~ 9 1 ~ 8
 Unit No. Condition No.

General purpose control
 Mode 4 (8 selectable output or decimal output)
 3 8 (X) X Y
 01 ~ 64 1 ~ 8, 0 (clear)
 (01 ~ 99) (0 ~ 9)
 Unit No. Condition No.

6. General purpose control
 Mode 5 (4 decimal digits output)
 3 9 X Y Y Y Y
 1 ~ 9 0000 ~ 9999
 (Unit No.) (4-digits)

- For a conference call, only those stations allowed to use the conference link can dial. The other members of the conference need not be allowed conference access.
- No. 200 programming of the specified station must be made in the exchange. For further details, please refer to Installation Hand Book for EXES-6000 CP unit.

The duration of the calling tone can be set for either 0.2 second (single note tone) or 0.3 second (warble tone). It is also possible to have the station without any calling tone.

Note.

1. The duration of the continuous calling tone is impossible to change.
2. Different modes of the duration of the calling tone may not be employed in each station within the same system.

Selectable Paging Pre-Announcement Tone Duration

The duration of the all-call and zone paging tones can be set for either 2 seconds ("long") or 1 second ("short"). It is also possible to have the system without any paging pre-announcement tone.

Time-Out of Conversation

It is possible to limit the conversation duration to one through ninety-nine minutes in the unit of one minute in order to improve speech path availability. A hurry-up tone is sounded in both the calling and called stations approximately 10 seconds before the busy stations are automatically disconnected from the speech path.

Time-Out of Paging Call

This function is employed to prevent the unnecessary line occupation as a result of a paging party's failure to depress the  key after a paging call establishment. The paging call is automatically cancelled after a certain period of time, which may be set at one through ninety-nine minutes in the unit of one minute, with a hurry-up tone transmitted to the paging station approximately 10 seconds prior to the automatic disconnection. When the paged party responds, the conversation is automatically cut off after the duration set by the Time-out of conversation function.

The in/out annunciation indicators can be turned on or off from any master station by using the personal number registering procedure.

When a personal number registration is made at a station, by dialing

• **61XXXX**

1000~1999 (personal number)

the personal number is registered at that station and the personal number lamp on the in/out indication panel is turned on.

Personal number call

By dialing

1XXXX

1000~1999 (personal number)

from any station, the call is put through to the station registered with the personal number.

Cancelling personal number and turning off in/out annunciation.

By dialing

•• **1XXXX**

1000~1999 (personal number)

from any station, the personal number is cancelled and the personal number lamp on the in/out indication panel is turned off.

1. The maximum number of in/out annunciation windows is 1000.
This maximum number remains same even if the number of exchange to be connected is increased to 2 or 3.
2. The in/out indication panel must be used with the Data Transmitting and Receiving Units (DT-E11 and DR-B61).

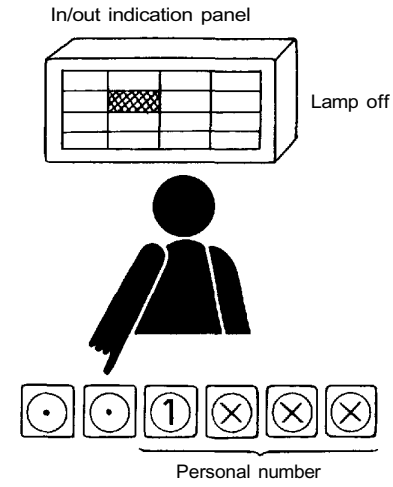
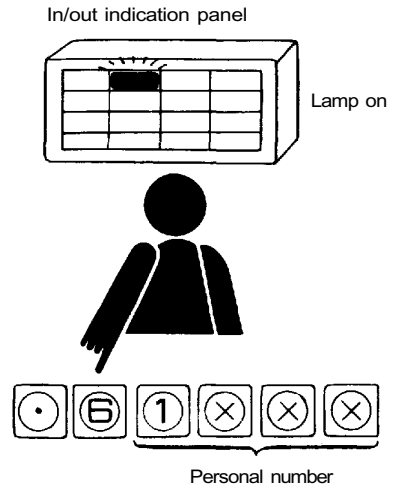

Calling Party Indication (Lamp Type)

A one station/one lamp type calling party indication panel can be provided for certain specified stations (eight stations or eight groups of stations)

The system can also be divided into a maximum of 8 groups of stations (consecutive station numbers) so that each group may have the calling party indication panels which are common within the group. The party making the call is indicated even if the call is made to any station in the group.

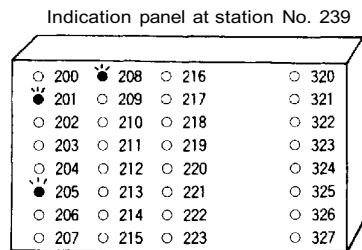

<Calling station memory>

It is also possible to equip the system with the "Calling station Memory" function. Adopting this function causes the calling party's lamp on the indication panel to keep on lighting even if he cancels the call when the called party is on other line or in Privacy mode.

< Indication mode without calling station memory >

1. A lamp of the calling station comes on and goes out when the conversation is over.
2. When the call is made during conversation or privacy mode, a lamp of the calling station comes on and goes out when the calling station cancels the call.

< Indication mode with calling station memory >

1. The lamp at the station receiving the call comes on when a call is made and goes out when the conversation is completed.
2. When a call (camp-on-busy) is made to the busy or the privacy station (with the privacy switch on), the lamp of calling station comes on. The lamp will not go out even if the original call is cancelled.
3. The lamp goes out after the conversation is cancelled.
4. Dialing



without placing a call causes all lights to go out. *1

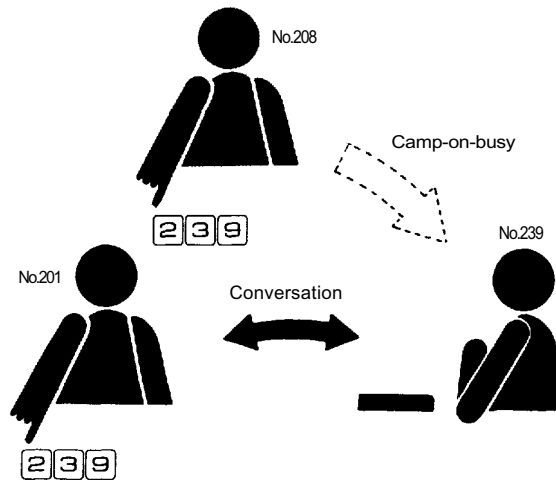

Note.

*1. In the case of Handset Master station TL-600M, lift a station handset and confirm that a dial tone is heard. Press [C] [C] after cancelling the dial tone by pressing [C]

1. The maximum number of calling stations is 120. When 2 or 3 exchanges are connected by tie-lines, the party who is calling through the other exchange is not indicated.
2. The indication panel must be used with the Data Transmitting and Receiving Units.
3. No. 200 programming of stations or groups of stations for which a calling party indication panel is provided must be set up in exchange "A", No. 470 programming in exchange "B" and No. 740 programming in exchange "C".

Example of registration

Indication panel	First station number	Last station number
1		
2	239	239
3		
4		
5	251	255
6		
7		
8		

1. Station No. 239 has the indication panel No.2.
2. The group of stations No. 251-255 is provided with the indication panel No. 5.

< Calling party selection >

1. When there are more than 2 incoming calls to a busy station, the calling parties' lamps on the indication panel come on. The called party may select the calling party he wishes to respond to by touch dialing $\square \square \square$ plus $\square \square \square \square$ (desired calling party's number). In this event, the original conversation is finished.
2. In the event that a station in the busy mode receives a call that is indicated on the indication panel, by touch dialing $\square \square \square \square$ (the calling party's number), the called party is put through to the calling party, while the original conversation partner is placed on "hold" temporarily. (Refer to "Call Transfer" and "Call Back".)

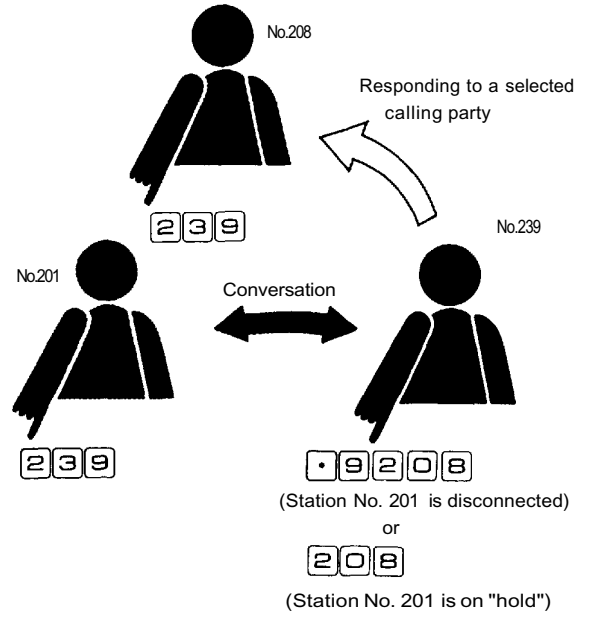
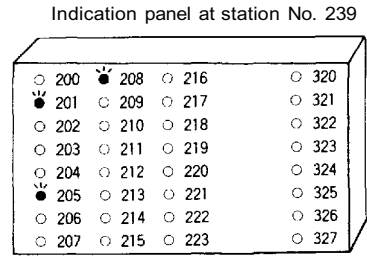

The system can be connected with usual type Pocket pager using the interface with Make/break relay output.

1. Dial

• 7 X X X

(00 ~ 99, Pager No.)

and the pager is called after confirmation tone is heard.

2. When

• 4 X X X

(00 ~ 99, Pager No.)

is dialed by the party called from the nearest master station, it is possible to respond a call to the station.

Note.

1. Once a receiver is called from one station and a response is waited for, camp-on-busy will result for other callers. But, if a response to the call is not received within 3 minutes, the terminal can be called from a new calling station.
2. If the pager is called after confirmation tone is heard, a calling station is disconnected from the speech line and waits for a response while the relay for pager transmission is kept in the Make position till a response is made. The station which waits for a response can be called from the other stations.
3. The other stations can call the other pagers while one station makes a call and is waiting for a response.
4. Dialing • 4 X X X (pager number that is called) cancels calling the pager if the wrong number has been pressed.
5. When the exchanges are connected by tie-lines, it is only possible to call the pager from the stations connected to the exchange "A" for stations No. 200 through 455. A pager response can be made from any station.

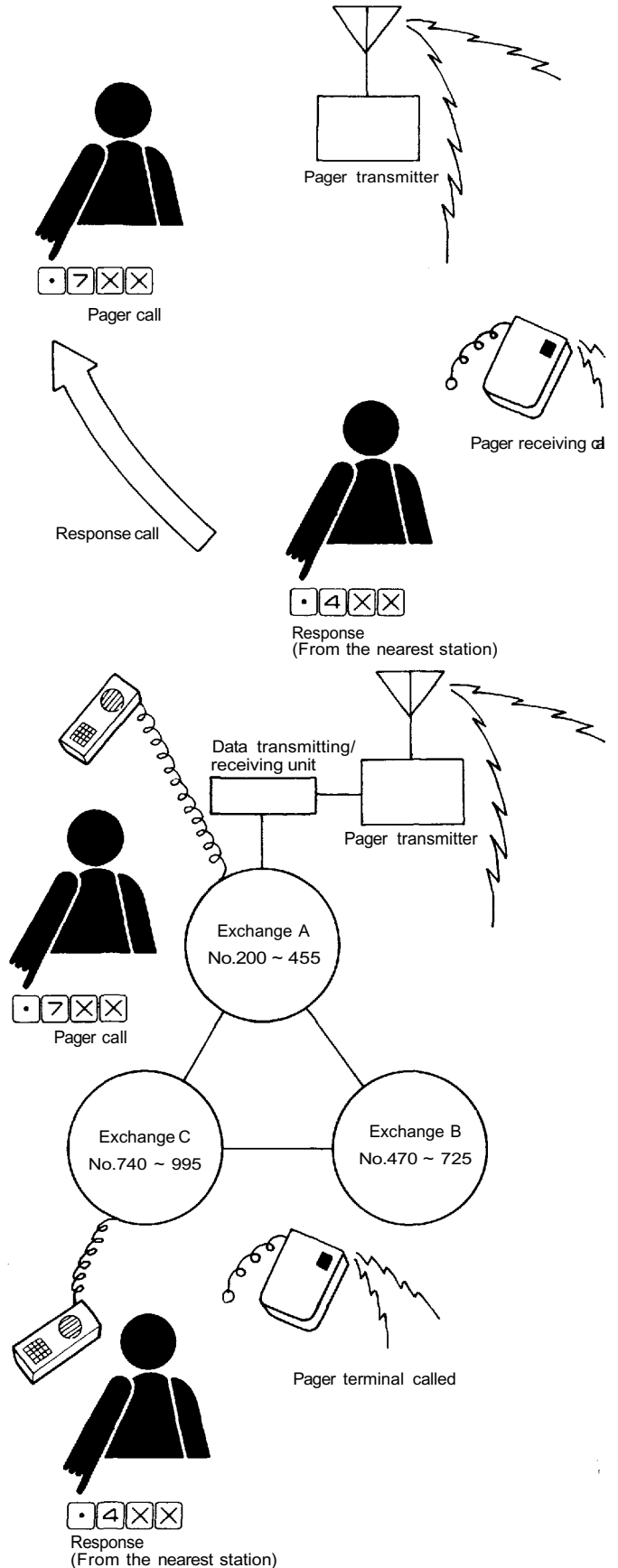

Station may be restricted from access to this function. This function can control other equipments by employing the Data Transmitting and Receiving Units.

Select the required type of output.

(Mode 1) One-shot make output (500/50 contacts)

Dial

• 3 (X) X X

00 ~ 49
(000 ~ 499)

and the relay output is made for 1 to 2 seconds.

Example: Door remote and VTR control

Note: Operation performed even when all link circuits are occupied.

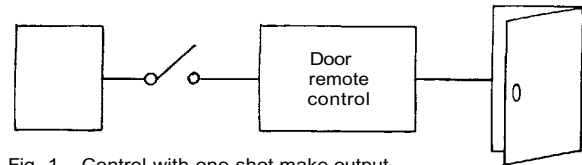

Fig. 1 Control with one-shot make output

(Mode 2) Make/break output (512/100 contacts)

Dial

• 3 5 (X) X X

00 ~ 99
(000 ~ 511)

and the make output is sent out.

Dial

• 3 6 (X) X X

00 ~ 99
(000 ~ 511)

and the break output sent out.

Example: In/out annunciation, Prescription annunciation.

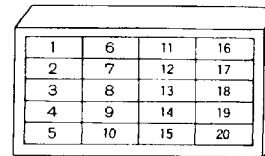

Fig. 2 Lamp on/off indication panel

(Mode 3) 8-selectable one-shot make output (9 units)

Dial

• 3 7 X Y

1 ~ 9 1 ~ 8
Unit No. Contact No.

and one contact out of 8 selectable make outputs is obtained for about 1 or 2 seconds.

Example: VTR control

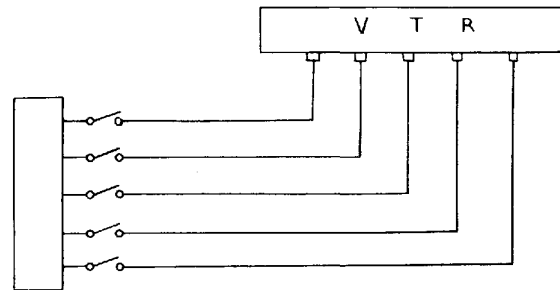

Fig. 3 VTR control with 8-selectable one-shot make output

(Mode 4) 8 selectable make output and/or decimal output

(A) 8 selectable make output (64/9 units)

Dial

• 3 8 (X) X Y

1 ~ 9 1 ~ 8, 0 (Clear)
Unit No. Condition No.

and one of the 8 relay outputs is made. "Clear" operation makes all 8 relays break.

Example: Destination indication, room condition indication, ITV control

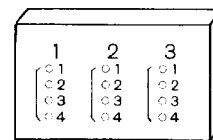

Fig. 4 8 selectable output type indication panel

(B) Decimal output

Dial

• 3 8 (X) X Y

1 ~ 9 0 ~ 9
(01 ~ 64) Condition No.
Unit No.

and the condition is indicated numerically.

Example: Destination indication, room condition

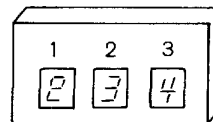

Fig. 5 Decimal output type indication panel

(Mode 5) 4 decimal digits output

Dial

• 3 9 X Y Y Y Y

1 ~ 9 0000 ~ 9999
Unit No. 4 decimal digits

and 4 decimal digits are indicated.

Example: Prescription annunciation

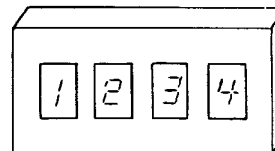
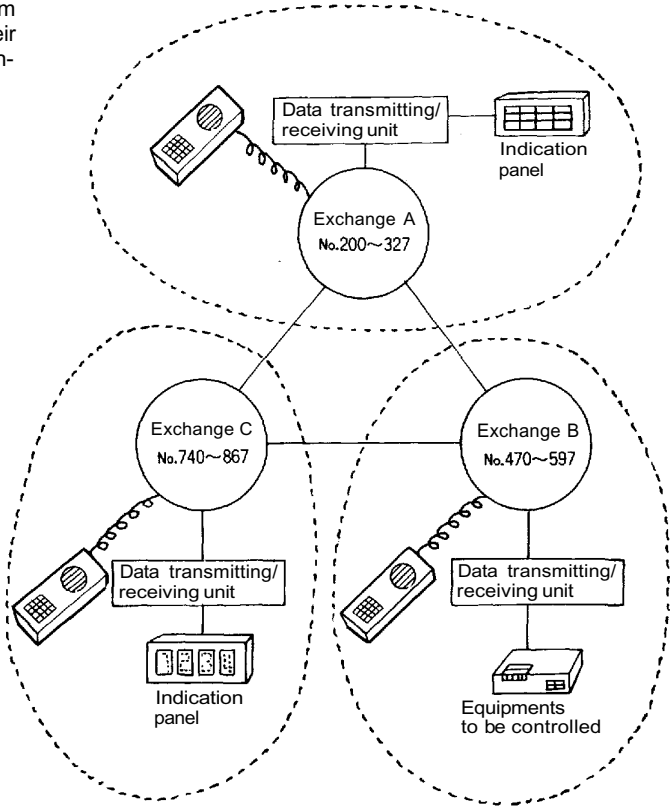

Fig. 6 4 decimal digits type indication panel

Note.

When 2 or 3 exchanges are connected by tie-lines, Data Transmitting and Receiving Units can be operated from the stations which share the same exchange but their operation is impossible from the stations which are connected to the other exchange.



Control of Data Transmitting and Receiving Units of each exchange is only possible from the stations sharing the same exchange and within the same areas circled in dotted lines.

If an external speaker is connected instead of a station, simplified paging can be made without the PA amplifier if the caller dials that station number and makes a paging call.

Note.
For further details, please refer to "Installation Handbook for Exchange"

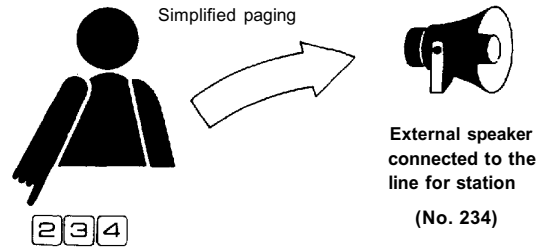

Clear Entry and Conversation Over

1. Clear entry

In the event that an error has been made when dialing for Transfer or Conference, at the start of or during the conversation, dial



This will restore the condition before the error was made, allowing the caller to make a correction without interrupting the call.

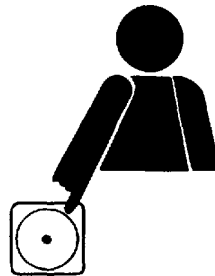

2. Conversation over

To terminate conversation, dial

 or hang up a handset

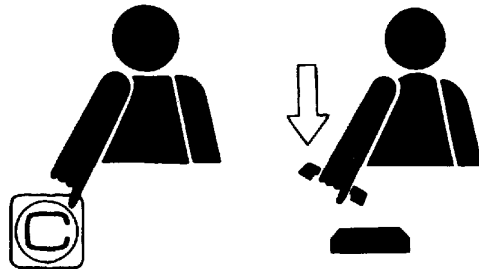



TOA ELECTRIC CO., LTD.
KOBE, JAPAN

Printed in Japan

Free Manuals Download Website

<http://myh66.com>

<http://usermanuals.us>

<http://www.somanuals.com>

<http://www.4manuals.cc>

<http://www.manual-lib.com>

<http://www.404manual.com>

<http://www.luxmanual.com>

<http://aubethermostatmanual.com>

Golf course search by state

<http://golfingnear.com>

Email search by domain

<http://emailbydomain.com>

Auto manuals search

<http://auto.somanuals.com>

TV manuals search

<http://tv.somanuals.com>