

# VIZUA•LOGIC



*A-1000*<sup>™</sup>

**HEADREST VIDEO MONITOR  
SYSTEM with BUILT-IN DVD**

*Owner's Manual*

# VIZUA•LOGIC

A Division of TMI Products, Inc.

1493 Bentley Drive • Corona, CA 92879 • 951-272-1996 • 800-624-7960 • Fax 951-272-1584

[www.vizualogic.com](http://www.vizualogic.com)

99-9110-000

## Welcome

Congratulations on your purchase of a Vizualogic A-1000 System that will provide your family with many years of enjoyment. This sophisticated product provides video entertainment to rear seat passengers without altering the appearance of your vehicle's original interior.

Reviewing this owner's manual thoroughly prior to operation will provide you with the best performance and help explain the simple requirements for proper care.

### Important Safety Information:

*This video product is designed and intended for positioning in back seating areas of a vehicle where it cannot be viewed directly or indirectly by the driver and possibly cause him/her to be distracted from the task of operating the vehicle. Driver distraction is a major cause of accidents and for this reason many states specifically prohibit the viewing of motion video within view of the driver while the vehicle is in motion.*

*For safety reasons, when changing discs it is recommended that the vehicle be stationary, and that you do not allow children to unfasten seat belts to change discs or make any adjustments to the system. System adjustments can be safely accomplished using the remote control unit. Enjoy your Vizualogic A-1000 system but remember the safety of all passengers is the number one priority.*

### Purchase Information

Please fill out this section for your reference and retain the original bill of sale to validate your Limited Warranty should service become necessary:

Date of Purchase: \_\_\_\_\_

Place of Purchase: \_\_\_\_\_

Unit Serial Number: \_\_\_\_\_

## How to Obtain Warranty Service

To obtain warranty service, the product(s) must be returned to a Company authorized installer accompanied by proof of warranty coverage.

### How State Law Relates to the Warranty

Some states do not allow limitation on how long an implied warranty lasts. In such states, the limitations or exclusions of this Limited Warranty may not apply. Some states do not allow the exclusion or limitation of incidental or consequential damages. In such states, the exclusion or limitation of this Limited Warranty may not apply to you. This Limited Warranty gives you specific legal rights and you may have other rights which vary from state to state.

### What is Excluded from this Limited Warranty

- This limited warranty excludes:
- Elimination of externally generated static or noise, or the correction of antenna problems or weak television reception.
  - Costs incurred for installation, removal or reinstallation of the product(s).
  - Damage to tapes, video games, software, camcorders, discs, speakers, accessories or vehicle electrical systems.
  - Cosmetic damage or damage due to negligence, misuse, abuse, failure to follow operating instructions, accidental spills or customer applied cleaners.
  - Damage due to environmental causes such as floods, airborne fallout, chemicals, salt, hail, windstorms, lightning or extreme temperatures.
  - Damage due to accidents, road hazards, fire, theft or vandalism.
  - Damage due to improper installation or connection, including connection to equipment of another manufacturer, modification of existing equipment, use of a faulty cassette tape or VCP head cleaning.
  - Product(s) which have been opened or tampered with for any reason or which have been damaged due to alteration or service performed by anyone other than the Company or a Company authorized installer.

## Limited Warranty

### Terms of Warranty

TMI Products, Inc (Company) warrants to the original retail purchaser that the automotive video product(s) purchased from a Company authorized installer, within the first ninety (90) days after new vehicle delivery, are free from defects in materials or workmanship under normal use and conditions for a period of three (3) years from date of purchase or the first 36,000 miles as registered on the vehicle's odometer at time of installation, whichever occurs first, with exception of remote control(s) which is warranted for a period of sixty (60) days from date of purchase. Products purchased or installed more than ninety (90) after new vehicle delivery are warranted for a period of one (1) year from date of purchase. A sales receipt is required to provide proof of date of purchase.

Should the product(s) be determined defective during the applicable warranty period, the defect(s) will be repaired or replaced with a new or reconditioned part(s), at the Company's option.

EXCEPT AS EXPRESSLY SET FORTH IN THIS WARRANTY, THE COMPANY MAKES NO OTHER WARRANTIES, EXPRESSED OR IMPLIED, INCLUDING ANY IMPLIED WARRANTIES OF MERCHANTABILITY AND FITNESS FOR A PARTICULAR PURPOSE. THE COMPANY EXPRESSLY DISCLAIMS ALL WARRANTIES NOT STATED IN THIS LIMITED WARRANTY. ANY IMPLIED WARRANTIES THAT MAY BE IMPOSED BY LAW ARE LIMITED TO THE TERMS OF THIS EXPRESSED LIMITED WARRANTY.

## Table of Contents

Welcome .....	2
Purchase Information .....	2
Features .....	3
Monitor Control Buttons .....	4
Remote Control Operation .....	5
DVD Basics .....	10
Playing Audio CDs .....	11
Playing MP3 CDs .....	12
Audio Playback .....	13
FM Modulator Playback .....	13
IR Headphones .....	14
Optional Accessories .....	15
Care & Maintenance .....	16
Troubleshooting/Specifications .....	17
Warranty .....	18
Warranty Service .....	19

## Features

- 7-inch Color TFT-LCD Panel with 16:9 aspect ratio
- Built-in Top-loading Slot-in DVD player.
- Integrated Infrared Transmitters for wireless Headphones
 

(1) Channel A	(2) Channel B
Audio-R: 2.3 MHz	Audio-R: 3.3 MHz
Audio-L: 2.8 MHz	Audio-L: 3.8 MHz
- RCA auxillary input
- Two sets of RCA slave outputs
- Three DIN monitor outputs
- Integrated IR Headphone Transmitter on the Front Panel
- 5 Control Buttons on the Front Panel – **MENU, UP, DOWN, POWER** and **SOURCE**
- OSD (On Screen Display) Control

## Monitor Control Buttons

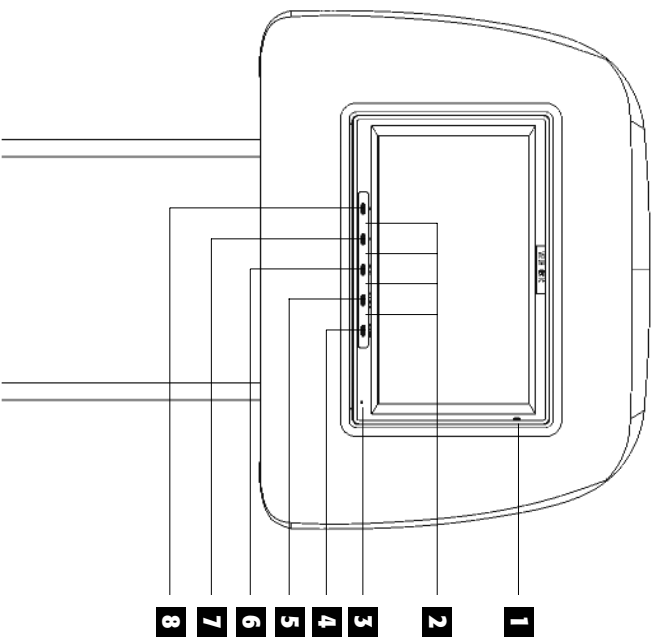

1. **IR Sensor** – Allows the remote to navigate the OSD (On Screen Display) on this unit and to control other functions and accessories.
2. **Infrared Transmitters** – Used to transmit audio to the wireless head-  
phone.
3. **POWER LED**
4. **POWER** – Soft-power on/off.
5. **SOURCE** – Selects the AV source from driver's headrest/passenger headrest/auxiliary input
6. **MENU** – Enters and navigates the OSD menus (Main Menu and Hidden Menu).
7. **UP** – Increases the selected value or navigates upwards through the options.
8. **DOWN** – Decreases the selected value or navigates downwards through the options.

## Troubleshooting

### No Picture

- (1) Verify that the correct video input mode is used on the monitor.
- (2) Verify that the video cables are securely connected.

### No Sound

- (1) Verify that the correct audio input mode is used on the monitor.
- (2) Verify that the audio cables are securely connected.

### IR Sensor Inoperative

- (1) Verify that the batteries in the remote are installed correctly and in good condition.
- (2) Verify that the remote sensor eye is not obstructed.

## Specifications

Display Type .....	LCD
Screen Size .....	7.0" (Diagonal)
Resolution .....	1440(W) x 234(H)
Brightness .....	400 nit max
Video Display System .....	NTSC/PAL
Horizontal View Angle .....	+/- 60°
Vertical View Angle .....	+60° / -30°
Operating Temperature .....	-10-70° C
Expected Backlight Life .....	10,000 hours
Operating Voltage .....	10 to 16V DC

## Care and Maintenance

Your Vizualogic System is a product of superior design and craftsmanship and should be treated with care. The suggestions below will help to fulfill any warranty obligations and provide many years of enjoyment.

- Cleaning the Monitor Screen and Housing: The components may be cleaned by occasionally wiping with a soft, lint-free, cotton cloth that has been slightly dampened with water.

**⚠ CAUTION: Do not use liquids, abrasives, aerosol cleaners, or paper cleaning products because they will result in permanent damage to the finish of your components! The LCD screen is made of a specially coated glass and can be scratched or damaged by abrasive or ammonia-based window cleaners.**

- Use and Storage:
  - These units contain precision electronics that must be protected from dust, dirt, and moisture.
  - Never spill liquids on any of the components. Liquids, humidity, and precipitation contain minerals that will corrode electronic circuits.
- Take care to avoid the following:
  - Rough handling can break internal circuit boards. Do not drop, knock, or shake the components.
  - Do not attempt to paint or refinish the components. Paint can clog moving parts and prevent proper operation.
  - The components can be damaged by non-expert handling. Attempting to open any of the components may void the limited warranty.

## Monitor Control Buttons (continued)

To open/reveal the DVD loading slot, PRESS on the top-center of the monitor frame (indicated by the Vizualogic logo).

**NOTE: Do not put pressure directly on the screen. Latch the monitor in the fully closed position when DVD loading slot is not in use.**

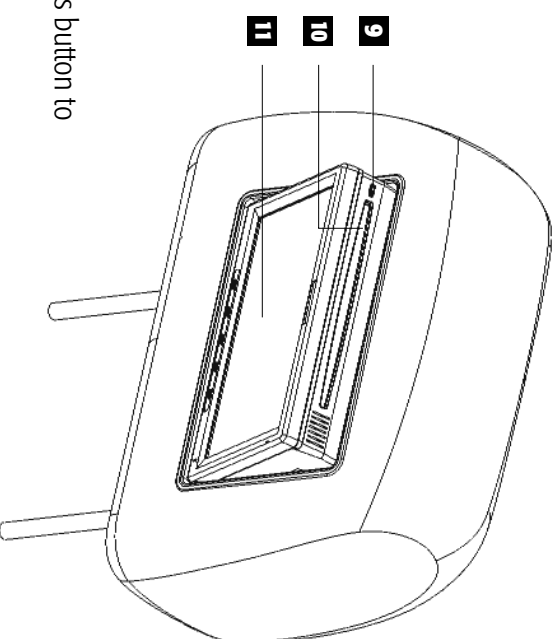
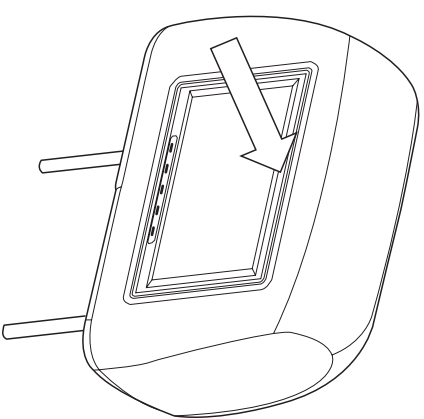

9. **EJECT** – Press this button to eject the disc.

10. **Disc Slot**

11. **LCD Panel**

## Remote Control Operations

*NOTE: The remote control will control all Monitor and integrated DVD functions. The remote is not a fully universal remote control and is only guaranteed to work with Vizualogic products.*

### MONITOR FUNCTIONS

1. **MONITOR POWER** – Press this button to turn the monitor ON. The current video source will be displayed on screen, and within a few seconds the picture will appear. Press the button again to turn the monitor OFF.
2. **SOURCE SELECT** – All video sources connected to the AV inputs can be viewed on the monitor by pressing this button. Each time the button is pressed, the AV source will change in the following sequence: AV1; AV2; AV3.
3. **DOWN** – Shifts left or down OSD menu. Decreases the value of TINT, COLOR, BRIGHTNESS, or CONTRAST bar.
4. **UP** – Shifts right or up OSD menu. Increases the value of TINT, COLOR, BRIGHTNESS, or CONTRAST bar.
5. **ZOOM** – Selects the screen-mode among wide/normal/zoom.
6. **PICTURE SELECT** – Press this button to change the value of TINT, COLOR, BRIGHTNESS, or CONTRAST.
7. **FM ON/OFF** – Press this button to turn on the Frequency Modulator. Press this button again to turn off the Frequency Modulator.
8. **FREQUENCY SELECT** – Press this button to select the desired Frequency Modulator channel.

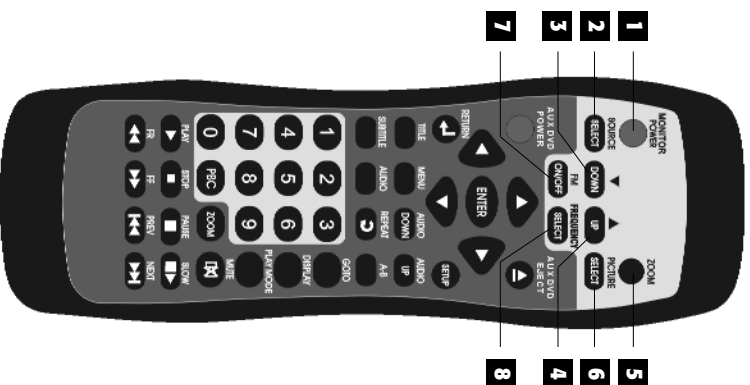

To increase the enjoyment and utility of your Vizualogic System, several accessories are available from your local authorized distributor/retailer:

## Optional Accessories

### WIRELESS STEREO HEADPHONES

- 2-channel
- IR headphones  
(90-3018)



## FM Modulator Playback (continued)

side monitor and pressing the **FREQUENCY SELECT** button. Each press of the button advances the frequency as follows:

FM CH1 87.9MHz ▶ FM CH2 88.3MHz ▶ FM CH3 88.7MHz ▶ FM CH4 89.1MHz ▶ FM CH5 89.5MHz ▶ FM CH6 89.9MHz ▶ FM CH7 90.3MHz

To turn the FM Modulator Off aim the remote at the driver's side monitor and simply press the **FM ON / OFF** button again.

**NOTE:** All of the FM modulator control functions can also be controlled in a similar fashion using the buttons on the front of the monitor.

## IR Headphones

The Vizualogic A-1000 System features integrated Infrared (IR) transmitters on the front of each monitor. The driver's side monitor transmits on channel 'A' and the passenger side transmits on channel 'B'. To listen to the source displayed on monitor, turn on the headphones and select the corresponding audio channel for the monitor being viewed. **NOTE: Always adjust volume control on the headphones to the lowest setting before turning them on.**

## DVD FUNCTIONS

9. **AUX DVD POWER** – Press this button to turn the (optional) external DVD ON. Press the button again to turn the DVD OFF.
10. **AUX DVD EJECT** – Ejects disc from the (optional) external DVD
11. **UP** – Moves up within the DVD SETUP menu.
12. **DOWN** – Moves down within the DVD SETUP menu.
13. **RIGHT** – Moves right within the DVD SETUP menu.
14. **LEFT** – Moves left within the DVD SETUP menu.
15. **ENTER** – Confirms a selection.
16. **RETURN** – Return to previous menu screen or playing point.
17. **SETUP** – Navigates SETUP MENU. There are 4 pages to configure System
  - (1) General Setup Page.
  - (2) Audio Setup Page.
  - (3) Preference Page.
  - (4) Password Setup Page.
18. **TITLE** – Navigates the Title Menu on the disc.
19. **MENU** – Goes to the Root Menu on the disc.
20. **AUDIO DOWN** – Press this button to decrease playback volume.

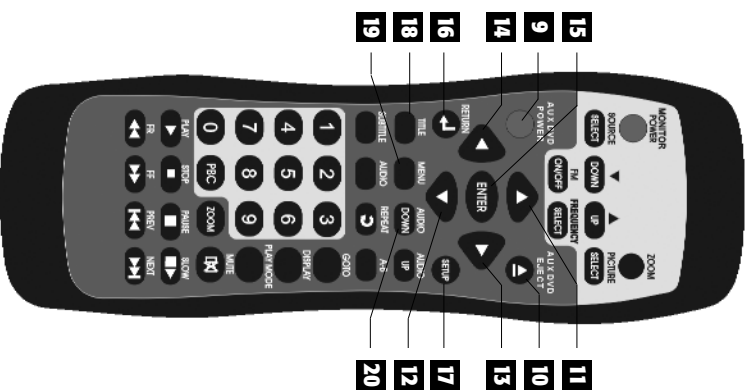

## Remote Control Operations (continued)

21. **AUDIO UP** – Press this button to increase playback volume.
22. **SUBTITLE** – Changes the subtitle language to other available languages or turns the subtitles off (only applicable if the disc contains multiple subtitle languages).
23. **AUDIO** – Changes the audio track to another available language (only applicable if the disc contains multiple audio tracks).
24. **REPEAT** – (Except VCD with PBC on) Repeats all or a part of a chapter, title, track, or an entire disc.
25. **A-B (Except MP3)** – Repeats disc from user selected point A to point B.
26. **GOTO** – Navigate the Goto Menu and go to the desired title, chapter, track or song on the disc.
27. **DISPLAY** – Show information on the left-up corner on the screen including title, chapter/track, time elapsed, and time remained, or turn off the display.
28. **PLAY MODE** – For MP3 use.
29. **MUTE** – Press this button to mute the audio to the wireless headphones. The screen will display 'MUTE' in the lower left corner when using this feature. Press the button again to restore audio to the previously set level.
30. **ZOOM** – Enlarge the picture in the movie by 2x, 3x or 4x. Shrink the picture in the movie by 1/2x, 1/3x, or 1/4x.
31. **PLAY** – Press this button to play a disc that is loaded into the integrated DVD player.

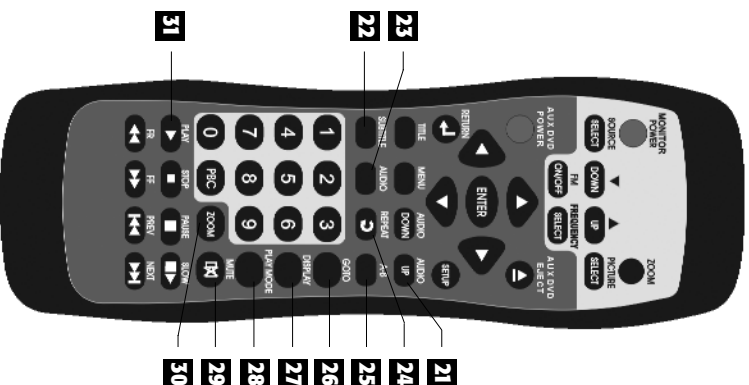

### SELECTING A PLAY MODE

You can temporarily choose what order the songs will play on a disc. The FOLDER play mode is the default playback mode. To access the play mode options, press **REPEAT** button.

The play mode options are as follows:

Single: Plays a selected song.

Folder: Plays the folder in the order the songs were recorded.

Random: Plays the songs in the random order.

Shuffle: Plays the songs in random order (from within the selected folder).

### USING THE REPEAT FEATURE

The default mode for the repeat feature is OFF. Pressing **REPEAT** multiple times changes the repeat option:

**REPEAT** One – repeats the song that is playing.

**REPEAT** Folder – repeats the folder that is playing.

## Audio Playback

The Vizualogic A-1000 System features multiple ways to enjoy the audio portion of a desired source. The audio can be experienced through the use of Infrared Headphones or with the integrated wireless FM Modulator

## FM Modulator Playback

To listen to the audio portion of the viewed source through the vehicle's stereo system aim the remote at the driver's side monitor and simply press the 'FM ON / OFF' button to turn the FM modulator on. The screen will now display FM CH1 87.9MHz. Tune the vehicle's radio to the corresponding station to listen to the source that is displayed on the driver's side monitor. The frequency that the FM modulator transmits on can be changed by aiming the remote at the driver's



## Playing Audio CDs (continued)

Using the **REPEAT** Feature

The default mode for the REPEAT feature is OFF. Pressing **REPEAT** button multiple times changes the REPEAT options as follows:

**Track** - repeats the current track that is playing.

**All** - repeats the entire disc that is currently playing.

## Playing MP3 CDs

MP3 is a format for storing digital audio. An audio CD quality song can be compressed into the MP3 format with very little loss of quality, while taking up much less disc space. CD-R/RW discs that have been encoded in MP3 format can be played on the integrated DVD player.

### SELECTING FOLDERS AND SONGS

When an MP3 disc is inserted in the player, the navigation screen appears automatically. You can change folders and songs by navigating through the file system. The DVD player plays the songs in order they were burned onto the disc.

1. If a disc is playing, press **STOP**. Press the **UP** or **DOWN** arrow button to go through the folder list on the left side of the navigation screen.
2. Once the folder you want is highlighted, press **ENTER**.
3. Press the **UP** or **DOWN** arrow button going through the song list and highlight the song you want. Press **ENTER** to begin the playback of the highlighted song.

### SKIPPING SONGS

Use **NEXT** (▶▶) button on the remote control to move to the next song. Use the **PREV** (◀◀) button to move to the beginning of the song currently playing. Press the button twice to move to the previous song.

32. **STOP** – Press this button to stop playing the movie or song.

**STOP** ▶ **PLAY**: Resumes play from where disc was stopped.

**STOP** ▶ **STOP** ▶ **PLAY**: Restarts play from the beginning of the disc.

33. **PAUSE** – Press this button to pause a disc that is loaded into the integrated DVD player. For more information, consult the DVD Basics section.

34. **SLOW** – Press this button to slow movie playback. There are 3 speed options to choose from: 1/2, 1/4, 1/8.

35. **FR (Fast Rewind)** – Press this button to search disc backward continuously. There are 5 speed options to choose from: 2X, 4X, 8X, 16X, and 32X.

36. **FF (Fast Forward)** – Press this button to search disc forward continuously. There are 5 speed options to choose from: 2X, 4X, 8X, 16X, and 32X.

37. **PREV** – Play the previous chapter or track.
38. **NEXT** – Play the next chapter or track.

39. **PBC (Video CD only)** – Turn the PBC (Play Back Control) on or off.

40. **NUMBERS 0 to 9** – Use these these buttons to access a specific chapter or track.

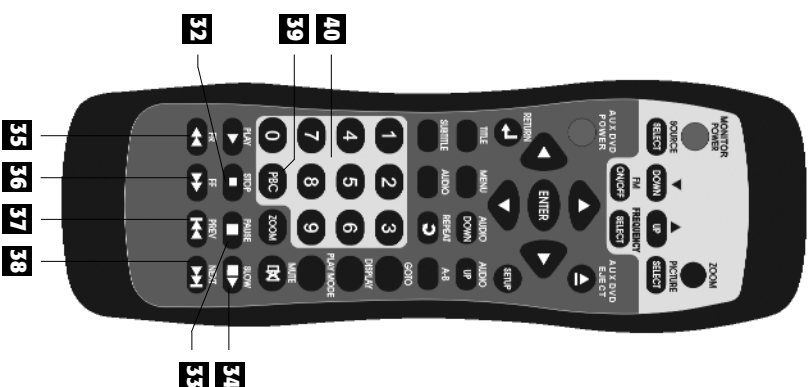

## OSD Function Control

**OSD MAIN MENU** – Press MENU key to enter OSD main menu, then select item in the menu by continuously hitting MENU key. Use the up and down buttons to change the value.

**CONTRAST** – Adjust CONTRAST value from 0-32 (default:16)

**BRIGHTNESS** – Adjust BRIGHTNESS value from 0-32 (default:16)

**COLOR** – Adjust COLOR value from 0-32 (default:16)

**TINT** – Adjust TINT value from 0-32 (default:16)

**SHARPNESS** – Adjust SHARPNESS value from 0-32 (default:16)

**WIDE SCREEN** – Changes the image size displayed onscreen from wide, normal, or zoom.

**RESET DEFAULT** – Resets all OSD adjustment values to default (except screenmode).

## DVD Basics

To get the maximum use out of your DVD player, make sure to review this section completely.

### REGIONAL CODING

Both the DVD player and disc are coded by region. These regional codes must match in order for the disc to play. The integrated DVD player has **region 1 coding**. DVD's with other regional codes cannot be played in this unit.

### TYPES OF DISCS THE INTEGRATED DVD PLAYER WILL PLAY:

- DVD-Video: DVD contains video.
- CD-DA: CD contains musical or audio content only.
- CD-Video: CD contains movie only.
- CD-R/RW: A disc that contains audio files (for example, a CD-R with downloaded MP3 Files), MPEG, or JPEG files.

### TYPES OF DISCS THE INTEGRATED DVD PLAYER WILL NOT PLAY:

- Optical disc
- ECD-1, CD-ROM, DVD-ROM
- Mini disc
- ECDG (audio only, not graphics).

### LOADING AND PLAYING A DISC

Press the **POWER** button on either the front of the monitor or the remote to turn the unit on. Push the top of the monitor, releasing the latch, allowing the screen to pivot forward, exposing the DVD player. Insert the disc into the loading slot (with the label side facing towards the rear of the vehicle) until the DVD player fully loads the disc. Return the monitor to the closed position by pushing on the top of the monitor until the latch engages.

## Playing Audio CDs

When playing an audio CD, the DISPLAY banner appears automatically. It displays the current track and the amount of the time for that track playing, the total amount of time on the disc and the current time running on the disc. Press the **DISPLAY** button on the remote to display the DISPLAY banner. The options below show you what happens when you press the **DISPLAY** button.

Press **DISPLAY (1x)** – “Single Elapsed” appears along with the current track number playing and the time of that track.

Press **DISPLAY (2x)** – “Total Remain” appears along with the current track number playing and the amount of time remaining on the entire CD.

Press **DISPLAY (3x)** – “Single Remain” appears along with the current track number playing and the amount of time remaining.

Press **DISPLAY (4x)** – “Total Elapsed” appears along with the current track number playing and the total time playing on CD.

## Free Manuals Download Website

<http://myh66.com>

<http://usermanuals.us>

<http://www.somanuals.com>

<http://www.4manuals.cc>

<http://www.manual-lib.com>

<http://www.404manual.com>

<http://www.luxmanual.com>

<http://aubethermostatmanual.com>

Golf course search by state

<http://golfingnear.com>

Email search by domain

<http://emailbydomain.com>

Auto manuals search

<http://auto.somanuals.com>

TV manuals search

<http://tv.somanuals.com>