

VIZUA·LOGIC™



A-1285/6
ALL-IN-ONE HEADREST
MONITOR/DVD SYSTEM
Owner's Manual

TABLE OF CONTENTS

Important Safety Instructions.....	1
Package Content.....	2
System Overview.....	3
Installation.....	4
Cable Connection.....	6
IR Remote Control.....	8
Touch Menu Screens.....	9
System Settings.....	11
Compatible Disc Types.....	21
Technical Specification.....	23

WELCOME

Congratulations on your purchase of the Vizualogic RoadTrip RT Series. This system will provide your family with many years of enjoyment. This sophisticated product provides video entertainment to rear seat passengers without altering the appearance of your vehicle's original interior.

Reviewing this owner's manual thoroughly prior to operation will provide you with the best performance and help explain the simple requirements for proper care.

IMPORTANT SAFETY INSTRUCTIONS



CAUTION: TO REDUCE THE RISK OF ELECTRIC SHOCK, DO NOT REMOVE COVER (OR BACK). NO USER SERVICEABLE PARTS INSIDE. REFER SERVICING TO QUALIFIED SERVICE PERSONNEL.

The lightning flash with arrowhead symbol within an equilateral triangle is intended to alert the user to the presence of dangerous voltage within the product's enclosure that may be of sufficient magnitude to constitute a risk of electric shock.



The exclamation point within an equilateral triangle is intended to alert the user to the presence of important operating and maintenance (servicing) instructions in the literature accompanying the appliance.



WARNING:

FCC regulations states that any change or modification to the equipment, not expressly approved by the maker or its authorized parties could void the user's authority to operate this equipment.

NOTE:

- Please dispose of empty batteries according to local regulations in your country.
- All On-Screen-Displays (OSD) and pictures will be based on the English version.
- Design and Specifications may vary in the manual from the actual product in use.

CAUTION:

The unit employs a laser system.

To ensure proper use of this product, please read this owner's manual carefully and retain for future reference. Should the system require maintenance, contact an authorized service location, see service procedure.

Use of controls, adjustments of the performance of procedures other than those specified herein may result in hazardous radiation exposure.

To prevent direct exposure to laser beam, DO NOT try to open the enclosure. Visible laser radiation may be present when the enclosure is opened. DO NOT stare into the laser beam.

Package Content



HEADREST W/ DVD MONITOR (2)



REMOTE CONTROL (1)



OWNERS MANUAL (1)



INSTALLATION MANUAL (1)



CONNECT CABLE (2)



AV BOX (1)



AV BOX POWER HARNESS (1)



Headphones (2)



AUX Cable (1)



USB Cable (1)

All-In-One System Features

Each Vehicle Specific All-In-One Kit Includes:

- Driver and Passenger side Vizualogic PerfectMatch Headrest with integrated Monitor and DVD Player(s).
- DVD and monitor function control via touch screen function.
- A/V control module with multi-source capability.
- Full function remote control. Controls monitor functions, DVD player functions, and A/V source input selection.
- Wireless dual channel infrared headphones.
- Integrated wireless FM modulator.

All-In-One System Connection Overview

1. A/V Control Module

2. Driver & Passenger Monitor A/V Output - Used to output signal to external devices such as aftermarket radios, wired FM modulators, auxiliary screen's ect.

3. FM Transmitter Antenna - Connects to the A/V Control Module via the terminal marked "ANT". Wirelessly outputs the user-selected audio sources information via one of seven user-selectable FM frequencies to the vehicle radio.

4. External A/V Input - Allows the connection of an external A/V source such as a DVD player, video game system, camcorder, etc. External A/V input is viewable by both headrest monitors.

5. Grey System Connector

6. Driver Monitor (Monitor A) Connectors - These color-coded outputs connect to the color-coded input terminals coming from the Driver Headrest.

7. Passenger Monitor (Monitor B) Connectors - These color-coded outputs connect to the color-coded input terminals coming from the Passenger Headrest.

8. System Power Input Terminal - Connects to the System Power Harness.

9. White System Connector.

10. System Power Harness - Connects to the power input terminal on the white system connector. Wires are color-coded and labeled as follows:

Yellow - +12 BATT (Constant Power)

Red - +12 ACC (Accessory Power)

Black - Ground

Green - Parking Brake

Note: Parking brake wire does not need to be connected for system to operate.

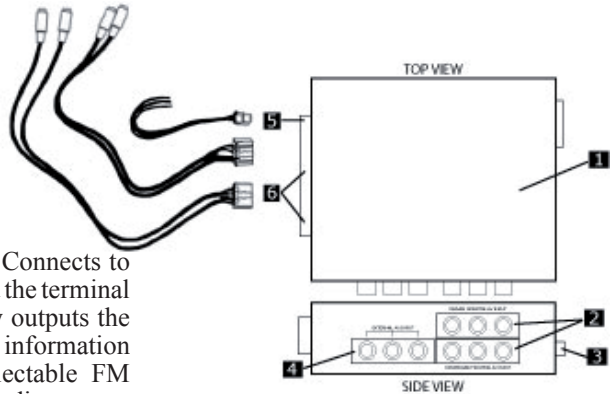

Headrest Installation

Section I - Headrest Installation

1. Remove the factory headrests (Detailed instructions can be found in the vehicle's service manual).
2. Starting with the driver's side headrest (Monitor A) insert the mini-din connectors into the driver side headrest post guides.
3. Slowly push the cables into the seat. If an obstruction is encountered, pull back slightly on the cable and rotate before continuing. Route the cables so that they exit the bottom of the seatback.
4. Repeat steps 2 and 3 for the passenger's side headrest (Monitor B).

Section II - Wiring

1. Place the A/V Control Module in a well protected area under a seat or behind a panel.
2. Insert the Monitor's system connector cables into the A/V Control Module. These connectors will click and lock into place when fully inserted.
3. Route the monitor and DVD cables from each headrest towards the A/V Control Module. If additional length is necessary use the available cable extensions.
NOTE: The available extensions are not interchangeable the cable connector colors must match.
4. Connect these cables from the driver side headrest (Monitor A) to the DRIVER MONITOR (Monitor A) the A/V Control Module.
5. Connect these cables from the passenger side headrest (Monitor B) to the PASSENGER MONITOR (Monitor B) on the A/V Control Module.
6. Connect the wireless FM modulator antenna to the connector jack on the side of the A/V control Module labeled ANT.
7. Extend and route the FM modulator antenna under the carpet or behind a panel ensuring to avoid any sharp metal edges or moving parts. For best results do not coil or bundle the FM modulator antenna.
NOTE: If the vehicle has an aftermarket radio that accepts RCA auxiliary inputs or the use of a wireless FM modulator is not desired, simply remove the modulator antenna and connect RCAs to the Driver Monitor A/V Output (located on the side of the A/V control module) and route them to the desired component.
8. Plug the power harness into the A/V control module and connect the power wire leads to 12V+ and 12V ground. The wires are color coded as follows: *Red = ACC Power, Yellow = Constant Power, Black = Ground, Green = Parking brake.*

Section III - System Set-up/Sub-Menu Controls

Enter the Sub-Menu, touch the “MENU” button on the screen to enter the Sub-Menu. Use the “▲” and “▼” buttons to move up and down within the Sub-Menu. Once the desired item has been highlighted, press the “MENU” button until the desired setting is achieved.

IR CHANNEL – This function changes the IR channel that the monitor transmits from: Ch. ‘A’, Ch. ‘B’ or ‘OFF’

NOTE: The driver’s side monitor is factory preset to ‘A’ and the passenger side monitor is factory preset to ‘B’. DO NOT set both monitors to the same IR channel, as this causes audible interference through the IR headphones.

SCREEN - Sets the power-up mode for the monitor when system power is turned on.

- “AUTO” - While in this mode the monitor will resume the last state it was in when the system power was last turned off.
- “ON” - When system power is turned on, the monitor will always turn on.
- “OFF” - When system power is turned on, the monitor will always remain off. The monitor must be turned on manually using the power button on the monitor or remote.

DVD MODE - Assigns the headrest identity to ensure proper source identification between Driver DVD, Passenger DVD, Ext. Aux, and Aux. via the on-screen display (OSD).

NOTE: The dual DVD headrest system’s default setting for the driver’s side is set to ‘Monitor 1’ and ‘Monitor 2’ for the passenger side. The single DVD headrest system’s default setting for the driver’s side is set to ‘DS’ and ‘PS’ for the passenger side. Do not set both screens to Monitor 1 / DS or Monitor 2 / PS. These settings must be observed in order to utilize the integrated FM modulator functions properly.

Single & Dual DVD System

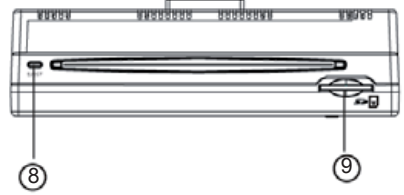
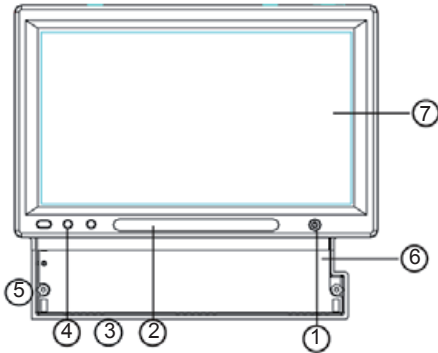

- | | |
|---|-----------------------|
| 1. Power Button | 6. DVD Loader |
| 2. Infrared Transmitter/Power Indicator | 7. Touch Screen Panel |
| 3. AUX Jack | 8. Eject Button |
| 4. Headphone Jack | 9. SD Card Reader |
| 5. Mini USB Port | |

Single DVD System Only

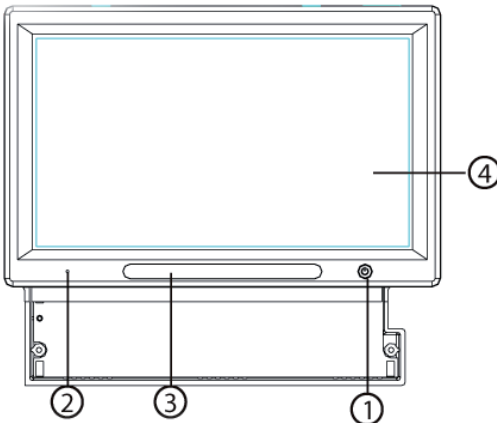

1. Power Button
2. Power Indicator
3. Infrared Transmitters
4. LCD Touch Screen

Single & Dual DVD System

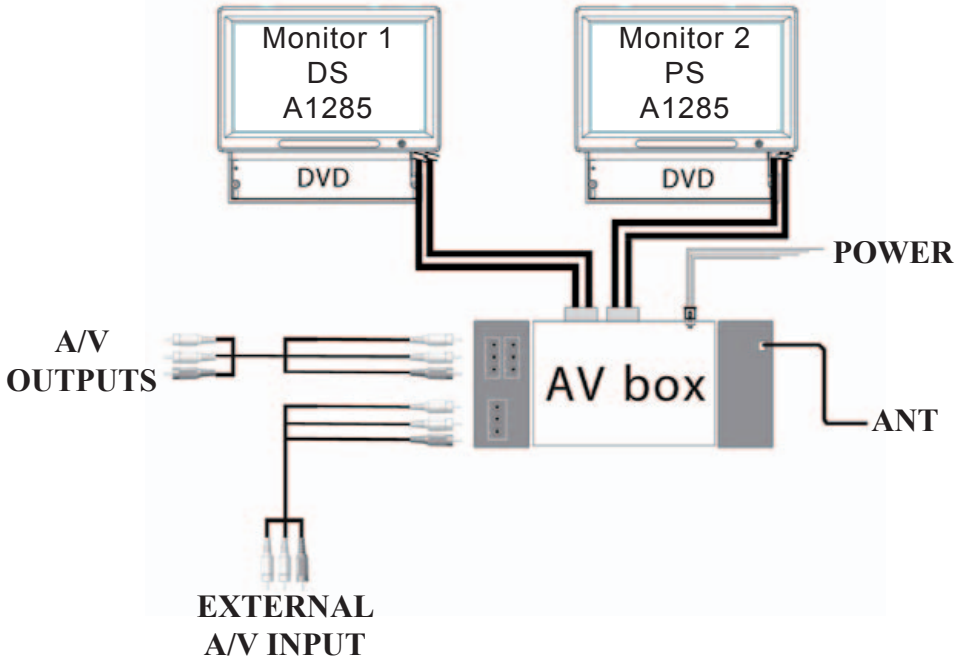

Single DVD System Only

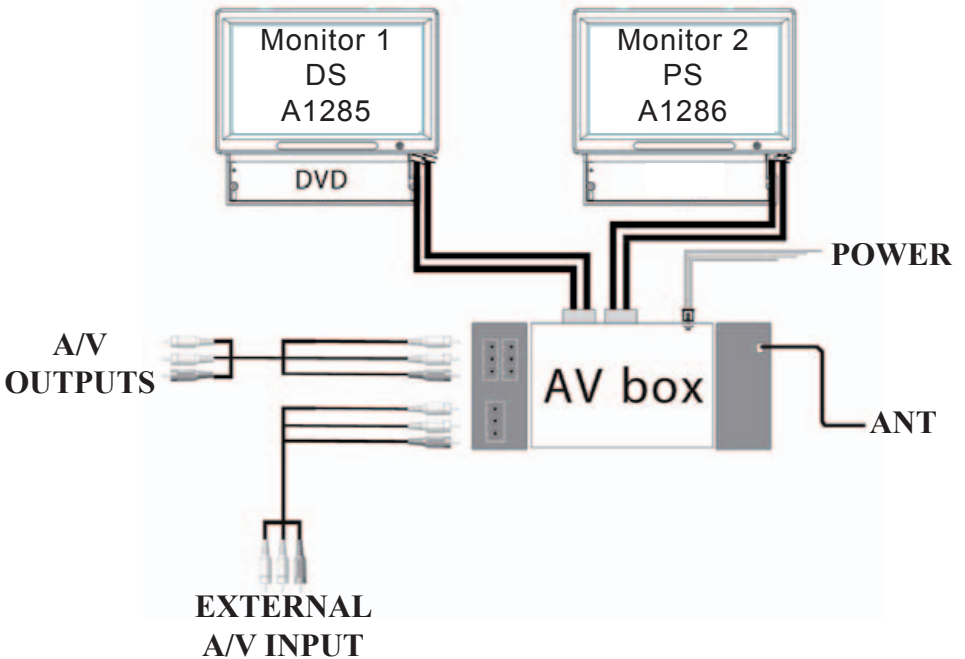

The IR Remote Control

Point the remote control no more than 3-4 meters (approx. 21 feet) from the remote control sensor on the front of the player. Keep remote within a $\pm 30^\circ$ angle.

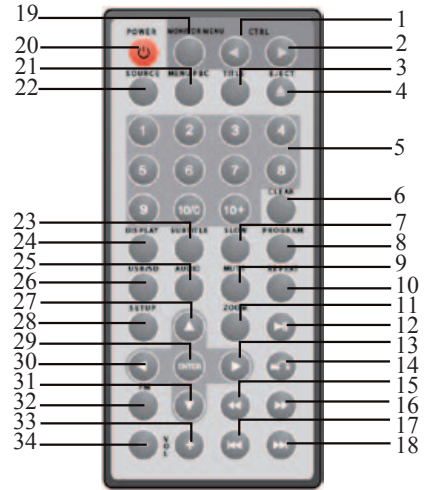

1. Adjust Decrease	13. Right Arrow ►	25. Audio
2. Adjust Increase	14. Stop / Return	26. USB / SD
3. Title	15. Fast Reverse ◀◀	27. Up Arrow ▲
4. Eject	16. Fast Forward ▶▶	28. Setup
5. Number Buttons	17. Previous ◀◀	29. Enter
6. Clear	18. Next ▶▶	30. Left Arrow ◀
7. Slow	19. Monitor Menu	31. Down Arrow ▼
8. Program	20. Power	32. FM
9. Mute	21. Menu/PBC	33. Volume +
10. Repeat	22. Source	34. Volume -
11. Zoom	23. Subtitle	
12. Play / Pause ►	24. Display	

NOTE:

- The distance may vary according to the brightness of ambient light.
- If the remote is not used for an extended period of time, remove the batteries to prevent possible damage from battery leakage and/or corrosion.
- DO NOT place any objects between the remote control unit and the sensor on the RT System.
- DO NOT use the remote control unit while simultaneously operating a remote control unit from another device. They may interfere with each other resulting in improper operation.
- Depending on usage, the batteries in the remote control should normally last for about one year. If the remote control isn't working, replace the batteries with new batteries and try again.
- DO NOT mix old batteries with used ones.
- DO NOT mix rechargeable batteries with non-rechargeable batteries.
- Incorrect usage of batteries may cause them to leak, corrode or explode.
- If leakage from the batteries occur, properly clean the battery compartment before attempting to install new batteries.
- Make sure the IR sensor is not obstructed by any objects.

TOUCH MENU SCREENS

Once the unit is connected to the appropriate power source, press the POWER button to power the unit ON. Touch any area of the screen to enter the menu screen. The screen will display as below.

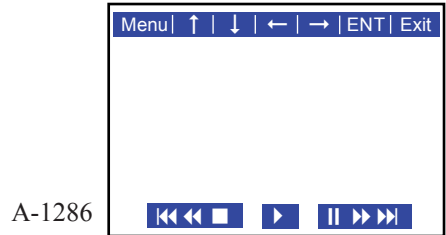
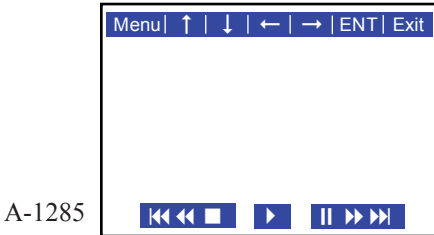

To enter the Main Menu screen, simply press the MENU key on the upper left corner. The screen will display as below.

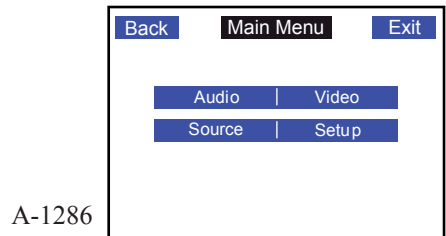
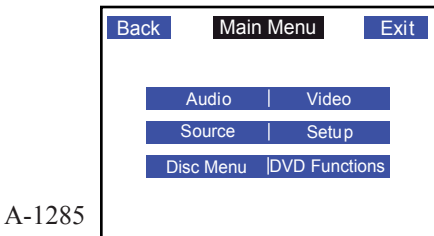

Pressing the SOURCE menu key will take you to the SOURCE menu. Here you can select the AV source type. Select the desired source and press EXIT to exit the main menu. The screen will display as below.

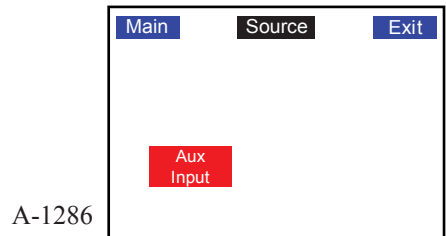
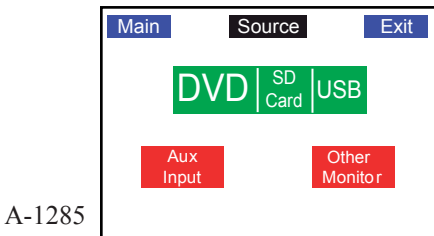

To get to the SETUP menu, touch any area of the screen to enter the main menu. Then press the SETUP menu key. The SETUP screen allows you to setup the basic functions of the unit. The screen will display as below.

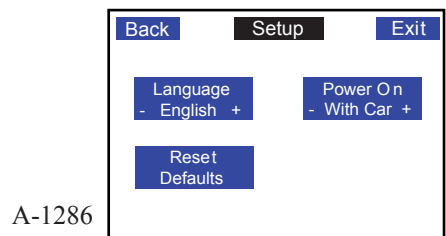
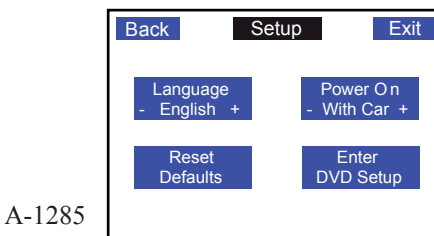

Press the AUDIO menu key to enter the AUDIO setup menu. This screen allows you to set the FM modulator settings as well as the IR settings.

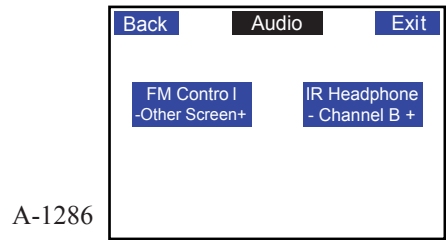
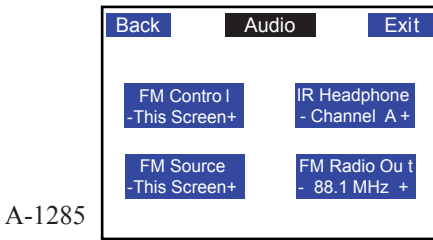

Press the VIDEO menu key to enter the VIDEO setup menu. This screen allows you to adjust the picture settings.

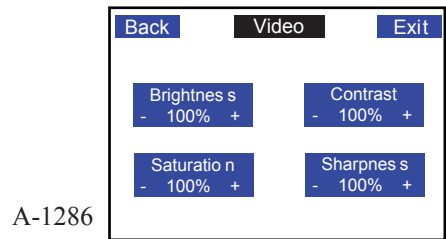

Pressing the DISC menu key will allow you to go back to the disc's Title or Root menu. Press EXIT to exit the DISC menu.

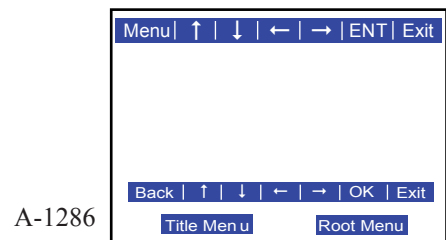
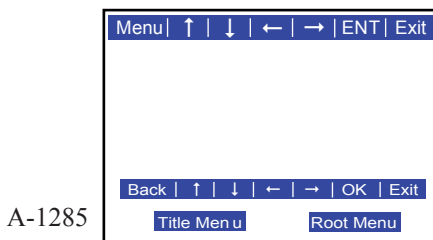

Pressing the DVD Functions menu key will allow you to setup the special functions of the DVD.

NOTE: DVDs with the following function(s) may be required to use the function keys.

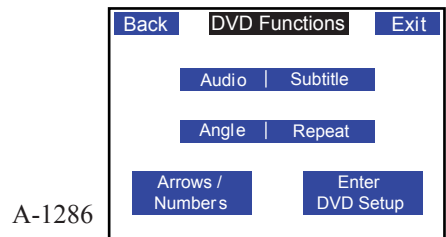
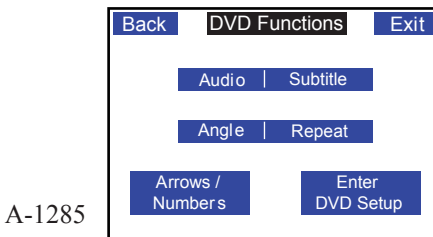

SYSTEM SETTINGS

Press **SETUP** on the Remote Control to enter the system setting menu.

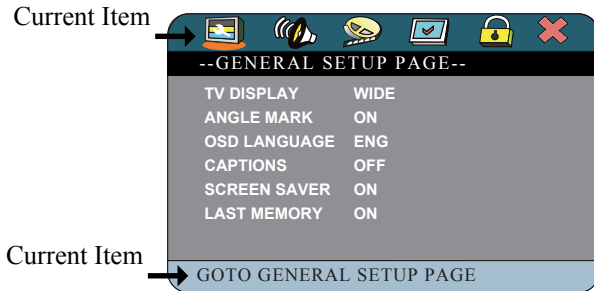

On the Remote Control, press either the **▲ UP** or **▼ DOWN** or **◀ LEFT** or **▶ RIGHT** arrow buttons to move to the desired menu item and press **PLAY** to select the menu item.

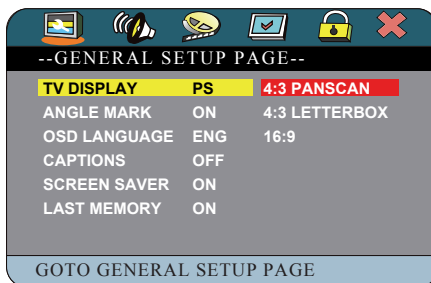

Set TV Display mode to the correct ratio:

- Press the **▶ RIGHT** arrow buttons to enter the sub-menu. If you want to set the screen to "WIDE", press the **▼ DOWN** arrow twice to move your selection until the "WIDE" item is selected, press **ENTER** to select.
- Press **SETUP** to exit these system settings.

NOTE: There are three (3) screen ratio modes available: 16:9 WIDE, 4:3LB (Letter Box) and 4:3PS (Pan Scan). Different disc formats will display different images depending on the screen setting and size used. Here is an example of the different screen ratio format.



4:3LB Allows you to see movies in their original aspect ratio. The entire frame of the movie will be displayed. 16:9 recorded movies will occupy a smaller portion of the screen and you will see black margins above and below the picture.



4:3PS The movie will be shown in full screen without any black margins. Parts of the image will be cutoff from the right and left side.



16:9 Allows you to see movies in their original aspect ratio.



16:9 Depending on the DVD screen format (e.g. 2.35:1), the wide screen setting may still have black margins above and below the picture.

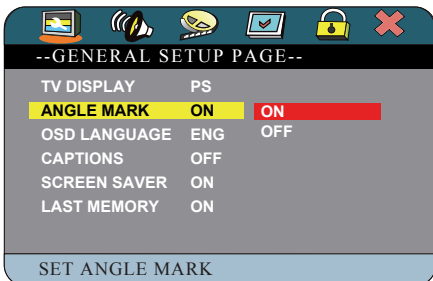

When playing a DVD disc with the Angle option set to ON, the screen will display the angle mark. This will give you the possibility to view multiple angle DVDs. When the Angle option is set to OFF, no angle mark will be displayed.

NOTE: DVD must have multiple angle options for this option to work.

To select the language for your On Screen Display (OSD) use this menu item. There are multiple languages available.

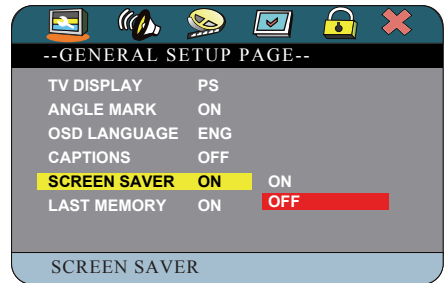
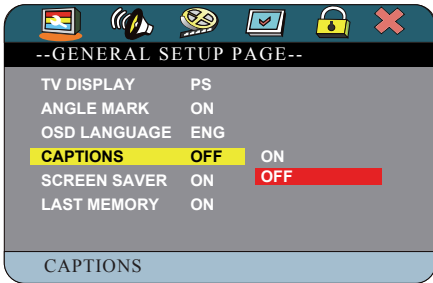

ON: To display captions (Subtitles).
OFF: Captions will not be displayed (No Subtitles)

When there is no activity with the player for some time, a screen saver will start to prevent damage to the screen. Select **ON** to activate the screen saver function or select **OFF** to deactivate this function.

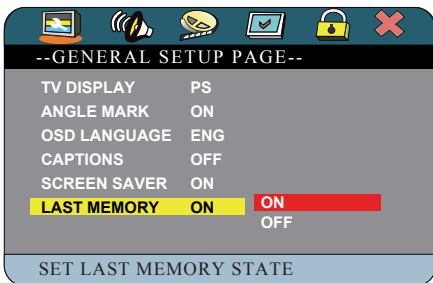

ON: When you turn off the player, it will memorize the last play time. So if you turn on the player the next time and the same disc is played, it will resume play from the last memory point.

OFF: Disable the last memory function.



Press **ENTER** to enter the Analog Audio setup page. The next page will be shown:



Set sound mix output mode:

- Press the **▶ RIGHT** arrow to enter the sub-menu. If you want analog stereo signals, set the sound mode to "STEREO"; press the **▼ DOWN** arrow once to move the selection to "STEREO", then press **ENTER**.

- If you want to have Dolby Pro Logic stereo (the decoded signal will create a 2ch reality simulating effect via the R/L connectors), select "LT/RT" then press **ENTER**.

You can select one of these modes to adjust the Bass and Treble signal to your liking. **ON** will switch the selected mode on and **OFF** will switch it back to normal Audio playback. ➡

NOTE: Please be advised that sometimes the BASS on an Audio CD or DVD is already very low, using the Bass Boost or Super Bass can overload your speakers resulting in poor sound quality.

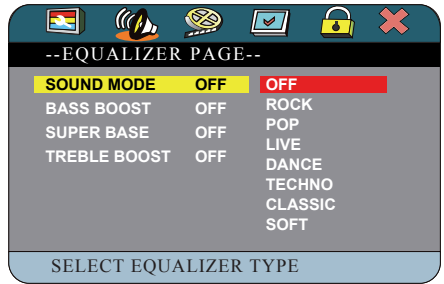

Select the **EQUALIZER** menu item to setup your preferred Equalizer mode. Press **ENTER** to enter this selection.

You can select one of these preset Equalizer modes to adjust the audio signal to your liking.

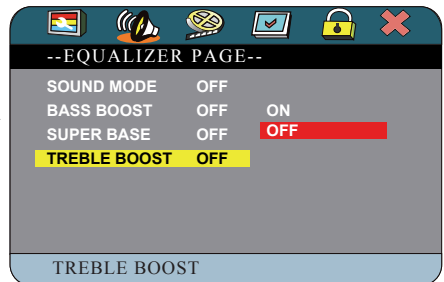
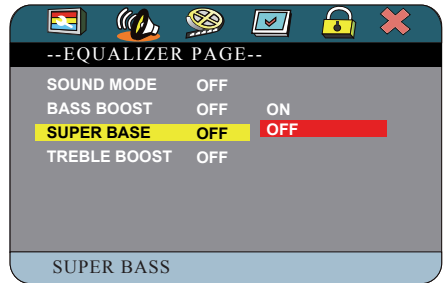
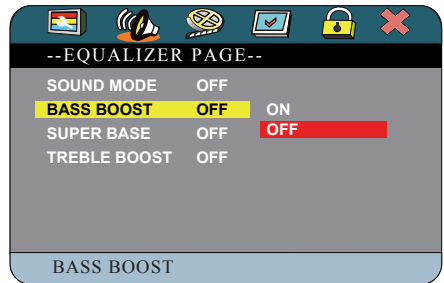

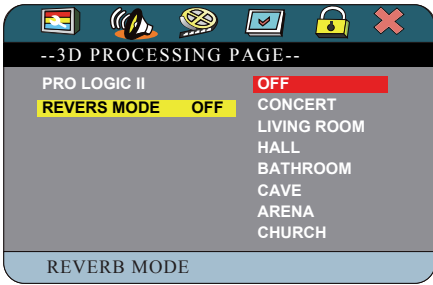

Select **3D PROCESSING** to setup your preferred 3D mode. Press **PLAY** to enter this selection and to set up your preferred Audio mode for a better surround effect. Press **ENTER** or the **RIGHT** arrow to enter this selection.

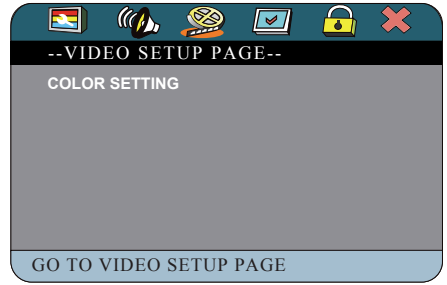

Select this menu item to setup your Video Quality modes. Press **ENTER** to enter this selection.

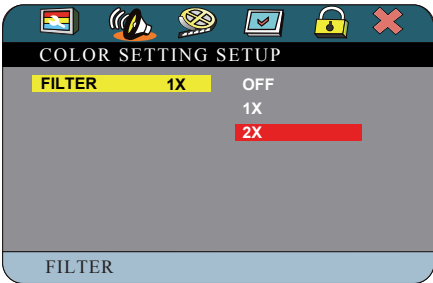

Select **HDCD** to setup your preferred Audio mode for HDCD. Press **ENTER** to enter this selection and to setup your preferred filter mode for HDCD (default is 1X).

1x = 48K Sampling, 2x = 96K Sampling

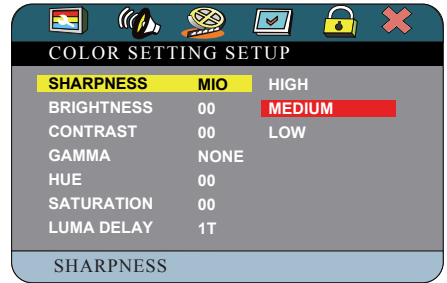

You can set the picture sharpness to these choices. If a video image is light, select the **LOW** option. If a video image is dark, select the **HIGH** option.

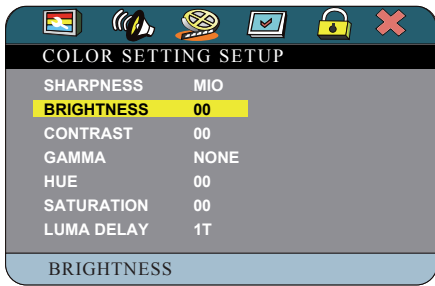

You can set the Brightness to your liking. Press **ENTER** or the **▶ RIGHT** arrow to enter the brightness control, then press the **▲ UP** or **▼ DOWN** arrow to adjust the image. Press the **◀ LEFT** arrow to go back to the menu.

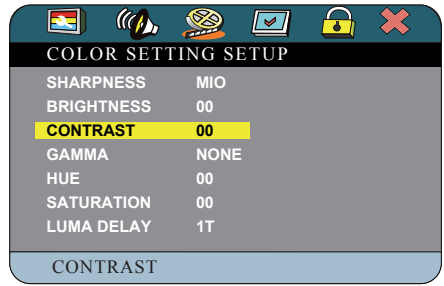

You can set the Contrast to your liking. Press **ENTER** or the **▶ RIGHT** arrow to enter the contrast control, then press the **▲ UP** or **▼ DOWN** arrow to adjust the image. Press the **◀ LEFT** arrow to go back to the menu.

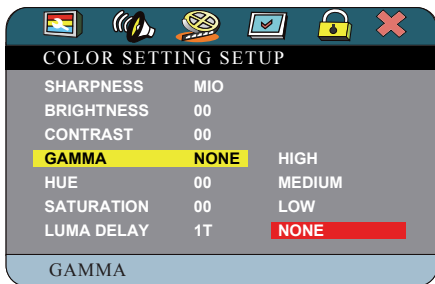
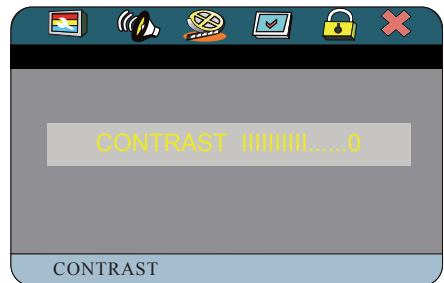

Gamma refers to the exponent between video or pixel values and the displayed brightness. You can set the Gamma to these choices.

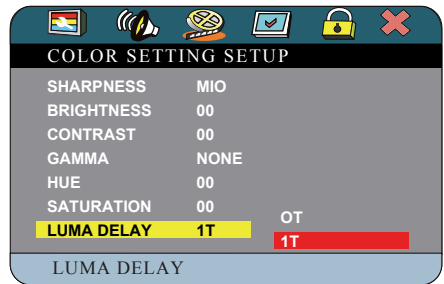

You can adjust the **Luma Delay** (Luminance Delay) by selecting one of these choices to best suit the brightness of your TV.

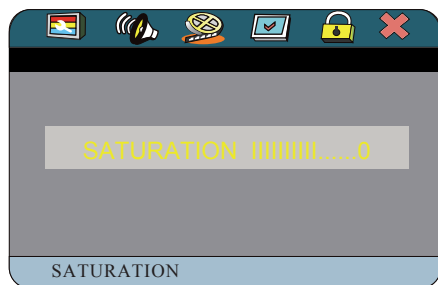
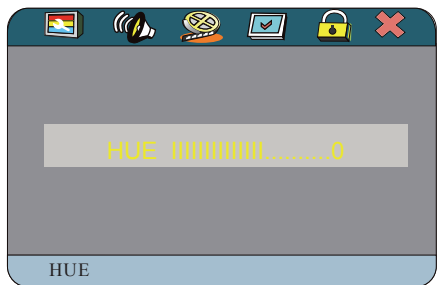
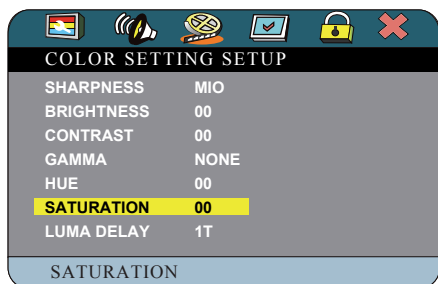
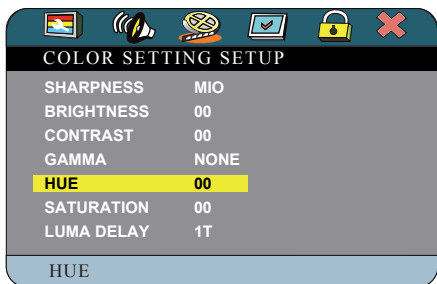

You can set the Hue (for NTSC) to your liking. Press **ENTER** or the **▶ RIGHT** arrow to enter the Hue control, then press the **▲ UP** or **▼ DOWN** arrow to adjust the image. Press the **◀ LEFT** arrow to go back to the menu.

You can set the Saturation to your liking. Press **ENTER** or the **▶ RIGHT** arrow to enter the Saturation control, then press the **▲ UP** or **▼ DOWN** arrow to adjust the image. Press the **◀ LEFT** arrow to go back to the menu.

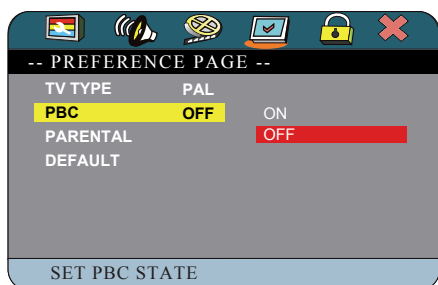
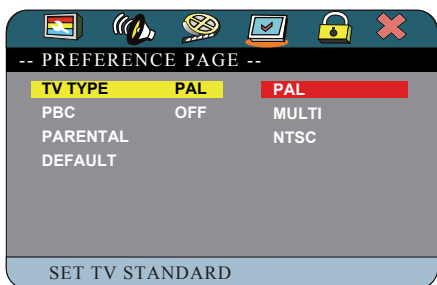

Select this menu item to set up your preferred video output format. PAL is commonly used in Europe while NTSC is commonly used in the USA and Japan. Select **MULTI** only if your TV supports both formats. The output signal will automatically follow the video format on the DVD disc.

For VCD and SVCD, this selection turns ON or OFF the Playback Control (PBC) function. VCD or SVCD media have PBC menus that contain the track list. The default PBC state is set to ON. In OFF mode, track(s) cannot be selected.

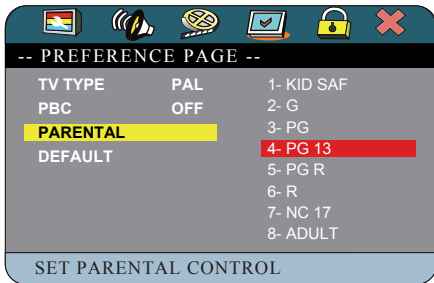

Set Age Control Grade:

For DVD discs with a rating system programmed (North America CARA) parents can prohibit watching content that might be inadvisable for children.

Press the ► RIGHT arrow to enter the submenu. If you want to change the age control grade press either the ▲ UP or ▼ DOWN arrow to scroll to the available selections.

Selection 1 is Kid safe.

Selection 2 is General Audiences.

Selection 3 is PG (Parental Guidance Suggested, some material may not be suitable for children).

Selection 4 is PG-13 (Parents strongly cautioned, some material may be inappropriate for children under 13).

Selection 5 is PG-R (Restricted, under 17 requires accompanying parent or adult guardian).

Selection 6 is Restricted Viewing.

Selection 7 is NC-17 (No one 17 and under admitted).

Selection 8 is for Adult Entertainment or X rated movies.

Hereafter, a screen will indicate to enter a password, if the factory password has never been modified, you can use [123456] by pressing the corresponding number buttons on the remote control. Select “YES” or “NO” with either the left or right arrow key and press **ENTER** to confirm.

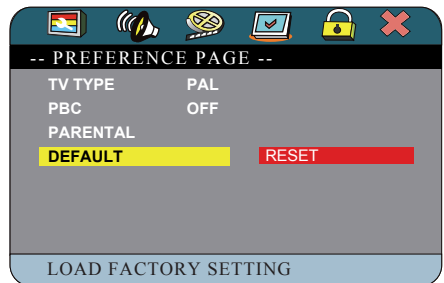

With this option you can select to reset to the factory preset values.

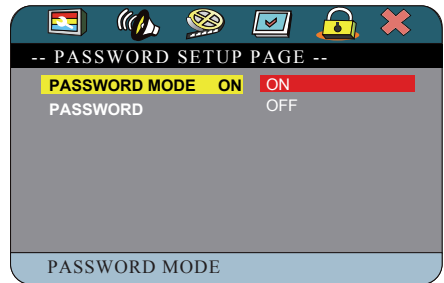

With this option you can select to set your password protection ON or OFF.

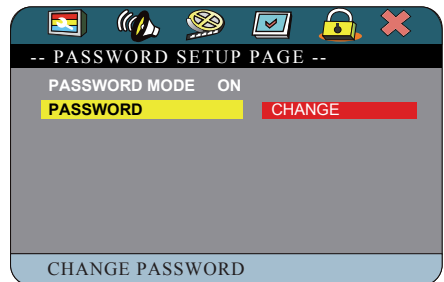

Use this menu to change the factory set password [123456].

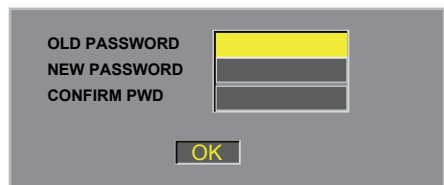

CREATING A PIN NUMBER

Enter the PIN number with the number buttons of the remote control and press **ENTER**. Now enter the new password and press **ENTER** again. Confirm your new password and press **ENTER** again to save the PIN number. Please write down the PIN number and store in a safe location.

Important: DO NOT forget the PIN number, there is no way to retrieve the PIN number if forgotten or lost.

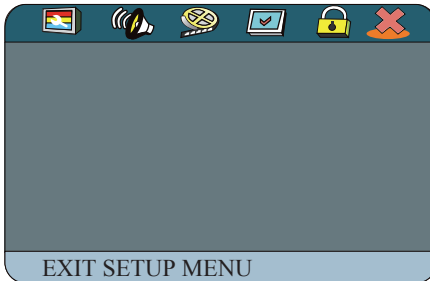

With this selection X you exit the system setup and return to normal viewing of the video.

MP3 / MPEG4 PLAYBACK

The Vizualogic RoadTrip RT Series DVD Player is able to play CD-R/CD-RW recorded with MP3/MPEG4 audio and video files. When a disc with MP3 or MPEG4 files (including multiple directories) is loaded in the system the following screen will display.

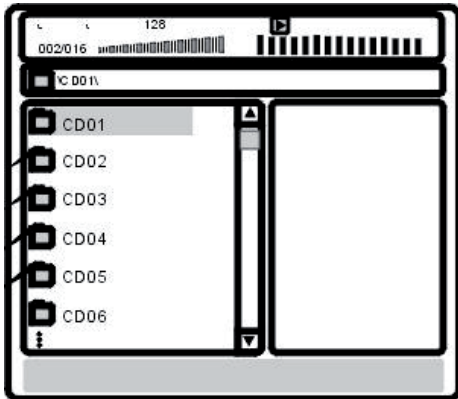

To go to the preferred music or video directory, press the ▲ and/or ▼ arrows to scroll to your selection and confirm your choice by pressing the **ENTER** button. To select your preferred song or video title, press the ▲ and/or ▼ arrows to scroll to your selection and confirm your choice by pressing the **ENTER** button. Your selected song or video will now play.

Play Mode:

There are five (5) play modes available when playing MP3/MPEG4 (.AVI) recorded discs:

SINGLE - All the songs / videos will be played only once.

REPEAT ONE - The current playing song / video will be repeated.

REPEAT FOLDER - Only the songs / videos of the current folder will be repeated.

FOLDER - Only all the songs / videos of this folder will be played once.

SHUFFLE/RANDOM - The songs / videos will be played in random order.

When the disc is playing, press REPEAT to select your repeat mode, the Display will show:

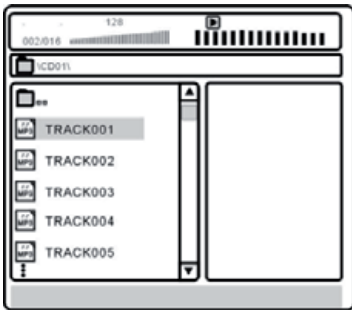

Other Functions

Functions such as MUTE, VOLUME, PAUSE, PREVIOUS, NEXT, etc. are also available for MP3/MPEG4 recorded discs. These operations are the same as playing an Audio CD.

COMPATIBLE DISK TYPES

Some DVD discs may have special requirements for playing, with which this system may not be compatible. Please refer to the specifications on the individual disc.

DISC TYPE	Content	Size	Total Play Time
DVD	AUDIO/VIDEO	12CM	About 4.7 GB - 2 hrs. (Single Side & Single Layer)
			About 8.5 GB - 4 hrs. (Single Side & Double Layer)
			About 9.4 GB - 4 hrs. (Double Side & Double Layer)
			About 17 GB - 8 hrs. (Double Side & Double Layer)
CD-DA	AUDIO	12CM	About 700 MB - 74 Minutes
MP3	MP3 AUDIO	12CM	About 700 MB - 300 Minutes

Discs Types

The RoadTrip RT Series can play the following types of discs: DVD / CD / CD-R / CD-RW / DVD-R / DVD-RW / DVD+R / DVD+RW. Other discs not listed cannot be played. Please DO NOT play discs smaller than 12cm or odd shape discs.

The RoadTrip RT Series uses the NTSC/PAL color systems. It cannot play discs recorded with other systems, such as SECAM.

Region Code

The region code for this player is 1 which indicates North America.

Copyright

According to the related laws, DVD discs without proper authorization are not allowed to be copied, broadcast, cable broadcast, or played publicly with the Vizualogic RoadTrip RT Series.

The Vizualogic RoadTrip RT Series incorporates copyright protection technology that is protected by the method of claims of certain U.S. patents and other Intellectual Property Rights owned by their rights owners. Reverse engineering or disassembly is prohibited.

How to hold disc

Do not touch the unlabeled side of the disc..

When there are stains on face of disc

Wipe gently with a wet cloth and then with dry one.

When a disc is brought in from a cold environment to a hot one, condensation can form on the face of the disc. Wipe down with a soft, smooth, dry cloth before using.

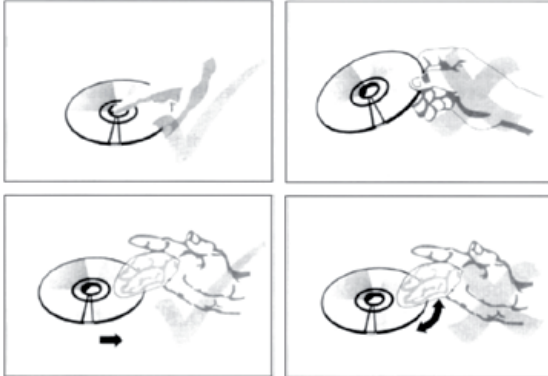

Attention:

Do not write on the unlabeled side of the disc.

Do not use chemical solutions to clean the DVD disc.

Do not stick labels or glue-based notes on the disc.

Do not use disks with glue residue or damaged labels.

Do not use anti-scratching materials or covers, that were not designed for this machine.

Do not put or store disk in the following environments:

Directly under the sunlight, in moist or dusty environments or beside heating elements.

Disc loading

- Load one disc with the data side facing upwards and make sure you do not touch the data side with your fingers.

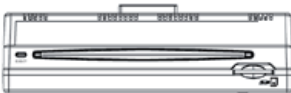

Once the disc is loaded, the unit will automatically start reading the disk and it will take a few seconds to download the disc initial data, thereafter the disc type will be displayed in the left upper corner of the LCD screen and the unit will start playing the disc.

TECHNICAL SPECIFICATIONS

Specifications:

- Multimedia player supports: DVD, DVD-R, DVD-RW, DVD+R, DVD+RW, CD, CD-R, CD-RW, VCD, SVCD, MP3 and JPG picture disks.
- MPEG4 support: DivX 3.11/4.02/5.02/5.03/5.05 DivX Pro/Subtitles .srt .sub
- Electronic Shock Protection (ESP) and Mechanical Shock Protection
- PAL/NTSC compatible
- Multi Lingual On Screen Display (OSD)
- Integrated Dome Lights with Door Sensor Connections
- A/V input via RCA connectors
- USB Connector
- Multi-Language Menu Selection

Kit Content:

- Dual Monitors with Integrated DVD Players (RT20 Only)
- (2) - Wireless Headphones (Batteries Included)
- Remote Control (Battery Included)
- A/V Box with A/V Cables
- User Manual

Specifications:

Power Consumption	12V DC (1 1-15V) /1.4A (Max 1.6A)
FM Stereo Transmitter	88.5MHz / 88.7MHz / 88.9MHz / 89.1MHz / 89.3MHz 89.5MHz / 89.7MHz / 89.9MHz
IR Carrier Frequency	2.3 / 2.8 MHz
TV Signal System	PAL/NTSC/MULTI
Laser	Semi-conductor laser, wave length 600nm, 780nm
Frequency Range	48 KHz pulse modulation 20 Hz ~ 22 KHz 96 KHz pulse modulation 20 Hz ~ 22 KHz
S/N	≥ 65 dB
Audio Dynamic Range	> 85 dB
Harmonic Distortion	0,01%
Input Sensitivity	500 mv
Operation Temperature	0 °C ~ 40 °C
Storage Temperature	-15 °C - 50 °C

VIZUALOGIC

DISCLAIMER

FM Modulator Notification for all European Union Vizualogic Customers.

Due to E-1 regulations pertaining to FM Modulation in aftermarket mobile electronics products, the following changes have been made for all Vizualogic headrest kits shipped to Europe:

- The systems will be shipped with the default set to FM Modulator OFF.**
- The FM Modulators will be inoperable as the antenna has been removed and the antenna receptacle disabled.**

1493 Bentley Drive - Corona - CA - 92879

www.vizualogic.com

Free Manuals Download Website

<http://myh66.com>

<http://usermanuals.us>

<http://www.somanuals.com>

<http://www.4manuals.cc>

<http://www.manual-lib.com>

<http://www.404manual.com>

<http://www.luxmanual.com>

<http://aubethermostatmanual.com>

Golf course search by state

<http://golfingnear.com>

Email search by domain

<http://emailbydomain.com>

Auto manuals search

<http://auto.somanuals.com>

TV manuals search

<http://tv.somanuals.com>