

VocoPro

ULTIMATE CHOICE OF KARAOKE ENTERTAINMENT

OWNER'S MANUAL

CDG-4000 PRO PROFESSIONAL CD/CD+G PLAYER

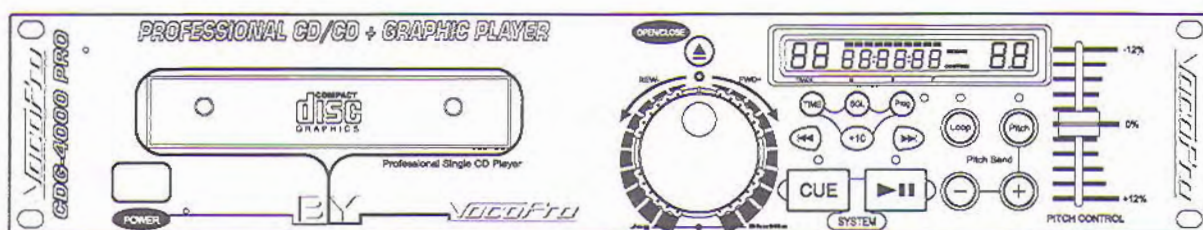

IMPORTANT INFORMATION: Thank you for choosing. The CDG-4000. To make full and effective use of this unit, please read this Owner's Manual carefully before operation.

IMPORTANT TO SAFETY

WARNING:
TO PREVENT FIRE OR SHOCK HAZARD, DO NOT EXPOSE THIS APPLIANCE TO RAIN OR MOISTURE.

CAUTION:

1. Handle the power supply cord carefully
Do not damage or deform the power supply cord. If it is damaged or deformed, it may cause electric shock or malfunction when used. When removing from wall outlet, be sure to remove by holding the plug attachment and not by pulling the cord.
2. In order to prevent electric shock, do not open the top cover. If a problem occurs, contact your dealer.
3. Do not place metal objects or spill liquid inside the CD player. Electric shock or malfunction may result.

Please, record and retain the Model name and serial number of your set shown on the rating label.

Model No. _____ Serial No. _____



CAUTION: TO REDUCE THE RISK OF ELECTRIC SHOCK, DO NOT REMOVE THE COVER (OR BACK). THERE ARE NO SERVICEABLE PARTS INSIDE.

REFER SERVICING TO QUALIFIED SERVICE PERSONNEL.



The lightning flash with arrowhead symbol, within an equilateral triangle, is intended to alert the user to the presence of uninsulated "dangerous voltage" within the product's enclosure that may be of sufficient magnitude to constitute a risk of electric shock to persons.



The exclamation point within an equilateral triangle is intended to alert the user to the presence of important operating and maintenance (servicing) instructions in the literature accompanying the appliance.

• FOR U.S.A. & CANADA MODEL ONLY

CAUTION

TO PREVENT ELECTRIC SHOCK DO NOT USE THIS (POLARIZED) PLUG WITH AN EXTENSION CORD, RECEPTACLE OR OTHER OUTLET UNLESS THE BLADES CAN BE FULLY INSERTED TO PREVENT BLADE EXPOSURE.

NOTE:

This CD player uses the semiconductor laser. To allow you to enjoy music at a stable operation, it is recommended to use this in a room of 5°C 41°F - 35°C 95°F.

DATE LABEL

MONTH YEAR

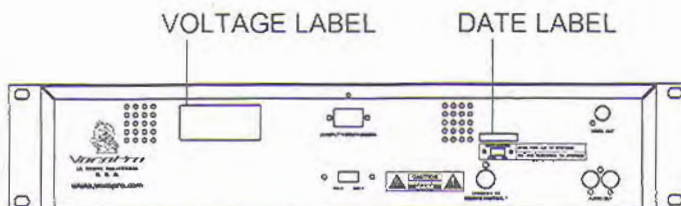

CAUTION:

USE OF CONTROLS OR ADJUSTMENTS OR PERFORMANCE OF PROCEDURES OTHER THAN THOSE SPECIFIED HEREIN IN THIS MANUAL MAY RESULT IN HAZARDOUS RADIATION EXPOSURE MAY RESULT IN HAZARDOUS RADIATION EXPOSURE.

THE COMPACT DISC PLAYER SHOULD NOT BE ADJUSTED OR REPAIRED BY ANYONE EXCEPT PROPERLY QUALIFIED SERVICE PERSONNEL.

DOUBLE INSULATED - WHEN SERVICING, USE ONLY IDENTICAL REPLACEMENT PARTS.

NOTE:

This unit may cause interference to radio and television reception.

• Line Voltage Selection (for multiple voltage model only)

- ★ The desired voltage may be set with the VOLTAGE SELECTOR switch on the rear panel, using a screwdriver.
- ★ Do not twist the VOLTAGE SELECTOR switch with excessive force as this may cause damage.
- ★ If the VOLTAGE SELECTOR switch does not move smoothly, please contact a qualified serviceman.

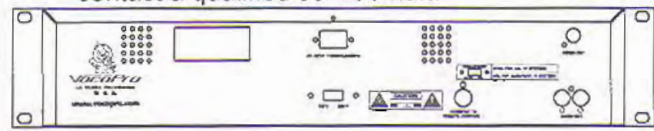
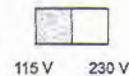

SAFETY INSTRUCTIONS

1. **Read Instructions** – All the safety and operating instructions should be read before the appliance is operated.
2. **Retain Instructions** – The safety and operating instructions should be retained for future reference.
3. **Heed Warnings** – All warnings on the appliance and in the operating instructions should be adhered to.
4. **Follow Instructions** – All operating and use instructions should be followed.
5. **Water and Moisture** – The appliance should not be used near water - for example, near a bathtub, washbowl, kitchen sink, laundry tub, in a wet basement, or near a swimming pool, and the like.
6. **Carts and Stands** – The appliance should be used only with a cart or stand that is recommended by the manufacturer.
- 6A. An appliance and cart combination should be moved with care. Quick stops, excessive force, and uneven surfaces may cause the appliance and cart combination to overturn. 
7. **Wall or Ceiling Mounting** – The appliance should be mounted to a wall or ceiling only as recommended by the manufacturer.
8. **Ventilation** – The appliance should be situated so that its location or position does not interfere with its proper ventilation. For example, the appliance should not be situated on a bed, sofa, rug, or similar surface that may block the ventilation openings; or, placed in a built-in installation, such as a bookcase or cabinet that may impede the flow of air through the ventilation openings.
9. **Heat** – The appliance should be situated away from heat sources such as radiators, heat registers, stoves, or other appliances (including amplifiers) that produce heat.
10. **Power Sources** – The appliance should be connected to a power supply only of the type described in the operating instructions or as marked on the appliance.
11. **Grounding or Polarization** – Precautions should be taken so that the grounding or polarization means of an appliance is not defeated.
12. **Power-Cord Protection** – Power-supply cords should be routed so that they are not likely to be walked on or pinched by items placed upon or against them, paying particular attention to the cord in correspondence of plugs, convenience receptacles, and the point where they exit from the appliance.
13. **Cleaning** - The appliance should be cleaned only as recommended by the manufacturer.
Clean by wiping with a cloth slightly damp with water. Avoid getting water inside the appliance.
14. **Disconnect power cord before servicing.**
15. **Replace critical components** ⚠ only with factory parts or recommended equivalents.
16. **For AC line powered units** - Before returning repaired unit to user, use an ohm-meter to measure from both AC plug blades to all exposed metallic parts. The resistance should be more than 100,000 ohms.
17. **Non-use Periods** – The power cord of the appliance should be unplugged from the outlet when left unused for a long period of time.
18. **Object and Liquid Entry** – Care should be taken so that objects do not fall and liquids are not spilled into the enclosure through openings.
19. **Damage Requiring Service** – The appliance should be serviced by qualified service personnel when:
 - A. The power-supply cord or the plug has been damaged; or
 - B. Objects have fallen, or liquid has been spilled into the appliance; or
 - C. The appliance has been exposed to rain; or
 - D. The appliance does not appear to operate normally or exhibits a marked change in performance; or
 - E. The appliance has been dropped, or the enclosure damaged.
20. **Service** – The user should not attempt any service to the appliance beyond that described in the operating instructions. All other servicing should be referred to qualified service personnel.
21. **Cleaning** – The appliance should be cleaned only as recommended by the manufacturer.
22. **Non Use Periods** – The power cord of the appliance should be unplugged from the outlet when left unused for a long period of time.

NOTES ON USE

- Allow for sufficient heat dispersion when installed on a rack.
- Handle the power cord carefully.
- Hold the plug when unplugging the cord.
- Keep the set free from moisture, water, and dust.
- Unplug the power cord when not using the set for long periods of time.
- Do not obstruct the ventilation holes. (For sets with ventilation holes.)
- Do not let foreign objects fall into the set.
- Do not let insecticides, benzene, and thinner come in contact with the set.
- Never disassemble or modify the set in any way.
- For 110 volt use in USA, USA nema style 110 volt plug. For other countries, use proper plug for the local outlet.

MAIN FEATURES

- (1) 8 times oversampling 1 bit D/A converter.
- (2) 4 different speed scans.
- (3) Frame search.
- (4) Auto cue.
- (5) 30 tracks program play.
- (6) Pitch display.
- (7) +10 tracks skip search
- (8) Single CD Graphics decoder

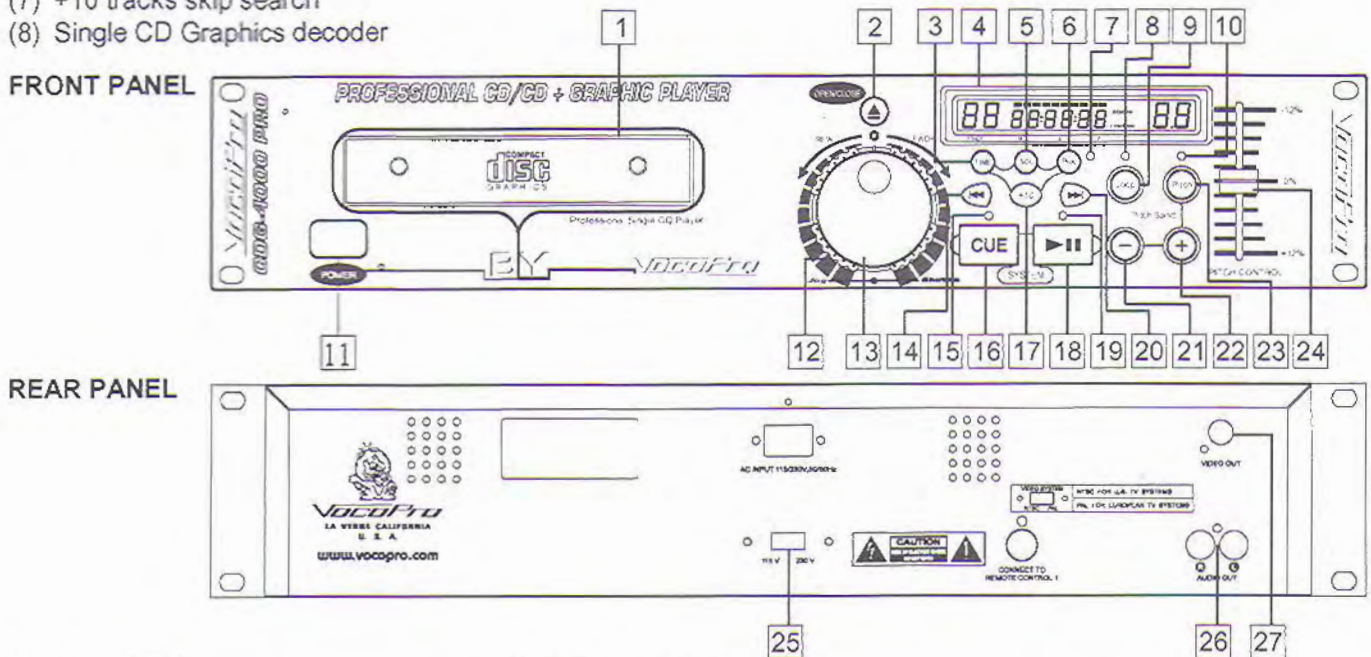

- | | | |
|------------------------------------|-------------------------------------|---|
| (1) Disc Holder | (10) PITCH Indicator | (20) F. SKIP ►► |
| (2) OPEN/CLOSE (Open/Close Button) | (11) POWER ⏻ (Power ON/OFF Switch) | (21) PITCH - (Pitch Bend - Button) |
| (3) TIME (Time Button) | (12) SHUTTLE (Shuttle Dial) | (22) PITCH + (Pitch Bend - Button) |
| (4) LCD (Liquid Crystal Display) | (13) JOG (Jog Dial) | (23) PITCH (Pitch Button) |
| (5) SGL (Single Button) | (14) B. SKIP ◀◀ | (24) Pitch Slider |
| (6) PROGRAM (Program Button) | (15) CUE Indicator | (25) Voltage Selector (Multi-voltage models only) |
| (7) PROGRAM Indicator | (16) CUE (Cue Button) | (26) LINE OUT |
| (8) LOOP Indicator | (17) +10 (Track +10 Button) | (27) VIDEO OUT |
| (9) LOOP (Loop Button) | (18) PLAY/PAUSE (Play/Pause Button) | |
| LCD | (19) PLAY Indicator | |

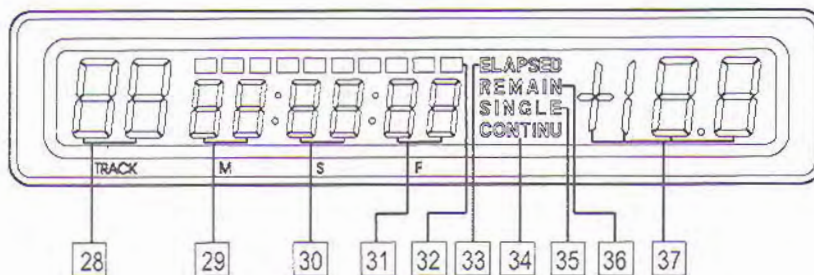

- (28) ~ (31) TRACK, MINUTE, SECOND and FRAME Displays
- (32) BAR Indicator
- (33) ELAPSED Indicator
- (34) CONTINUE Indicator
- (35) SINGLE Indicator
- (36) REMAIN Indicator
- (37) PITCH Display

PREPARATIONS

1. Checking the Contents

Check that the carton contains the following items:

- 1) Player unit
- 2) Operating instruction (this booklet)
- 3) RCA pin cord.

2. Installing the Unit

Mount the unit onto your console or rack with 19" EIA rack rails.

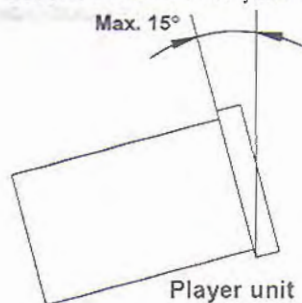

CAUTION:

The player will work normally when the unit is mounted with the front panel at within 15 degrees of the vertical plane. If the unit is tilted excessively, discs may not be loaded or unloaded properly.

3. Connections

- 1) Turn off the POWER switch.
- 2) Connect the audio outputs with the RCA cord to the audio input on your mixer.
- 3) Connect the video output with the RCA cord to the video input on your mixer or video switcher.

CAUTION:

- Be sure to power is off when connecting the pin cord.

NAMES AND FUNCTIONS

Below is a description of the functions of the controls listed on Page 3

Front Panel

(1) Disc Holder

Place the discs in the holder. Press the OPEN/CLOSE button to open and close the disc holder.

(2) OPEN/CLOSE ▲ (Open/Close Button)

Press it to open and close the disc holder. The disc holder cannot be opened during playback, so stop playback before pressing the button.

(3) TIME (Time Button)

Press this button to switch the time display between the elapsed time and remaining time.

The selected mode is indicated by the ELAPSED and REMAIN indicator on the LCD.

(4) LCD

(5) SGL (Single Button)

Press it to switch the single and continuous play modes. The SINGLE mode is indicated by the

SINGLE indicator on the LCD and continuous mode is indicated by the Continue indicator on the LCD.

(6) PROGRAM (Program Button)

Press the PROGRAM button, the player will enter the program mode and stop the CD playback.

(7) PROGRAM Indicator

The PROGRAM LED lights when program mode is set.

(8) LOOP Indicator

When the LOOP start point is set, the LED flashes. When in LOOP mode, the LED lights.

(9) LOOP (Loop Button)

Press the LOOP button to set the loop start point, press the LOOP button again to set the loop end point.

(10)PITCH Indicator

When the indicator lights, the pitch adjustment is enabled.

(11)POWER  (Power ON/OFF Switch)

When the POWER switch is pressed, the power turns on.

(12)SHUTTLE (Shuttle Dial)

Use the dial to select the scanning direction and speed. The disc is scanned in the forward direction when the shuttle dial is turned clockwise from the neutral position, in the reverse direction when the shuttle dial is turned counterclockwise. The scanning speed increases when the shuttle dial is turned faster.

(13)JOG (Jog Dial)

When the dial is turned during CD pause, the point at which the sound is being produced moves by the number of frames corresponding to the number of clicks. Clockwise moves the point forward, counterclockwise moves the point backward.

(14)B. SKIP 

Use the button to go back to the beginning of the current track or select a previous track for playing.

(15)CUE Indicator

When in CUE mode, the CUE indicator lights.

(16)CUE (Cue Button)

Press the CUE button during playback to return to the position at which playback started.

(17)+10 (Track +10 Button)

Use this button to skip ahead 10 tracks.

(18)PLAY/PAUSE Button

Use the button to start playback. Press once to start playback, once again to set the pause mode, and once more to resume playback.

(19)PLAY Indicator

The PLAY indicator lights during play mode.

(20)F. SKIP 

Use the button to skip to the next CD track.

(21)PITCH - Button

The CD slows down while this button is pressed. Release the button to return to the original BPM.

(22)PITCH + Button

The CD speeds up while this button is pressed. Release the button to return to the original BPM.

(23)PITCH (Pitch Button)

Use the button to enable or disable BPM adjustment with the pitch slider. BPM adjustment with the pitch slider is enabled when the PITCH LED lights.

(24)Pitch Slider

Use the slider to adjust the CD pitch. Slide up to decrease the pitch, down to increase the pitch.

Rear Panel

(25)VOLTAGE SELECTOR (Multi-voltage models only)

Use this to select the power voltage.

(26)LINE OUT

The audio signal from this player is output from the jack.

LCD

(28)~(31)TRACK, MINUTE, SECOND and FRAME Displays

These displays indicate information for the CD's current position and time.

(32)BAR Indicator

These ten indicators provide a visual display of the approximate position of the pickup within the current track.

(33)ELAPSED Indicator

It indicates that the time shown on the display is the elapsed time.

(27)VIDEO OUT

The video signal from the player is output from this jack.

(34) CONTINUE Indicator

When the indicator lights, the function will cause the unit to play continuously.

(35) SINGLE Indicator

When the indicator lights, playback will stop at the beginning of the next track.

(36) REMAIN Indicator

It indicates that the time shown on the display is the remaining time of playing track.

(37) PITCH DISPLAY

It shows the BPM change range, the BPM changes within a range of +/-12%.

OPERATIONS

1. Opening and Closing the Disc Holder

- Turn the unit power on. Press the OPEN/CLOSE button to open the disc holder.
- The disc holder cannot be opened during playback to prevent playback from being interrupted if the OPEN/CLOSE button is pressed accidentally. Stop the playback first, then press the OPEN/CLOSE button.

2. Loading discs

- Hold the disc by the edges and place it in the disc holder, then press the OPEN/CLOSE button again to close the disc holder. The unit will show the total track number and the total playing time for about 2 seconds then enter the cue position, the cue point will be set to the music starting point of the first track automatically.

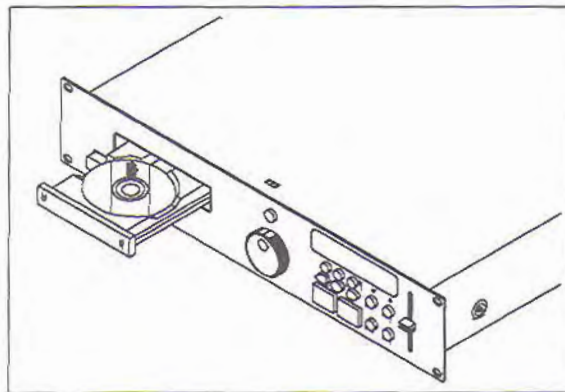

Figure 2-1

CAUTION:

- Do not place any foreign objects in the disc holder, and do not place more than one disc in the disc holder at a time.
- Do not push the disc holder in manually when the power is off, as this may result in malfunction and damages the player.

3. Selecting Tracks

- Press the SKIP button once to move to next higher or lower track.
- Hold the SKIP button to change tracks continuously at a higher speed.
- When a new track is selected during playback, playback begins as soon as the skip search operation is completed.
- If the skip **▶▶** button is pressed while at the last track, the first track is selected. In the same way, if the skip **◀◀** button is pressed while at the first track, the last track is selected.

4. Starting Playback

- Press the PLAY/PAUSE button during the pause or cue condition to start playback, the PLAY indicator lights.
- The point at which playback starts is automatically stored in the memory as the cue point. The pickup then returns to the cue point when the CUE button is pressed. (Back Cue)



Figure 4-1

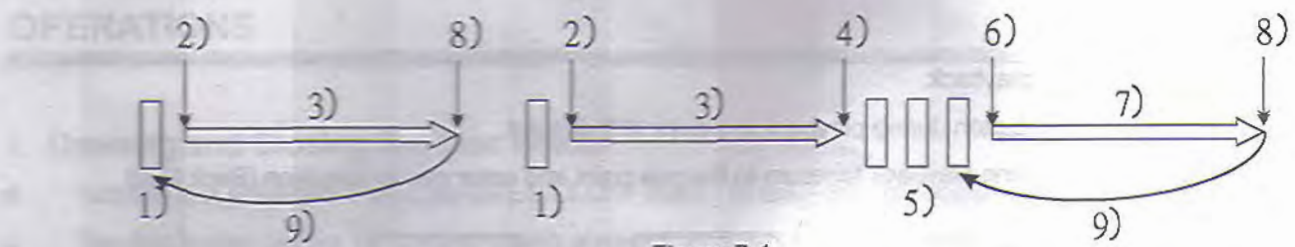

Figure 7-1

- ❶ The player has completed the cue or pause operation and is waiting for the play start command.
- ❷ When the PLAY/PAUSE button is pressed, playback starts and the cue point is stored in the memory.
- ❸ Playing.
- ❹ The pause mode is set when the PLAY/PAUSE button is pressed again.
- ❺ Pausing.
- ❻ When the PLAY/PAUSE button is pressed again, playback resumes and the new cue point is stored in the memory.
- ❼ Playing.
- ❸ Press the CUE button.
- ❹ The pickup returns to the cue point.(Back Cue)

- Cue point setting:

When play starts from pause or skip to a new track by using the skip button the beginning play point will be set to the new cue point.

When a new cue point is set, the cue indicator lights by flash for about 1 second.

NOTE: During cue mode, if the CUE button is pressed and held; playback will start from the cue point, when the button is released, the player will return to the cue mode automatically, it allows you to check the cue point.

8. Frame search (For audio playback only, will not work on graphics)

- Frame search is a function for monitoring the sound at a certain section of the disc and manually changing the position. Searching is used to set play start points with precision.
- Turn the JOG dial while in pause or cue mode to begin searching. The sound for one revolution of the disc is played repeatedly. The point at which the sound starts is indicated on the LCD.
- When the JOG dial is turned, the point from which the sound is output moves a number of frames corresponding to the number of the clicks, and the time display on the LCD also changes.
- The search point moves in the forward direction when the JOG dial is turned clockwise, in the reverse direction when the JOG dial is turned counterclockwise.

9. Scanning (Fast forward/Fast backward) (For audio play back only will not work with graphics)

- Scanning is a function for moving quickly forward or backward when the SHUTTLE is rotated.
- This unit supports 4 different speeds according to the rotating angle of the SHUTTLE.
- Turn the shuttle dial to begin scanning. The disc moves rapidly forward or backward and the sound is output. The current scan point is indicated on the LCD.
- Turn the shuttle dial clockwise to scan in the forward direction, counterclockwise to scan in the reverse direction.

10. Time display

Press TIME button to select time display mode:

- ① Elapsed time of a track.
- ② Remaining time of a track.

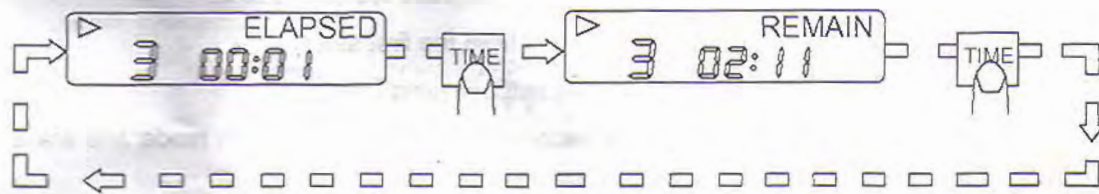

Figure 10-1

11. Matching the Beats Per Minute (BPM)

There are three tools available for matching the BPM of the two CDs:

- ① Use the pitch slider to adjust the BPM vertically.
- ② Use the PITCH BEND button to change the BPM temporarily.
- ③ Turn the JOG dial to change the BPM temporarily.

1) Pitch Slider

- ① To adjust the BPM by sliding the pitch slider up or down, press the PITCH button to turn on the PITCH adjustment function before using.
- ② Slide the pitch slider up to decrease BPM, or down to increase BPM. The adjustment range is +/-12%.

2) Pitch Bending

- The BPM increases or decreases respectively while the PITCH BEND+ or PITCH BEND- button is pressed.
- The BPM increase depends on how long you hold the button. If you hold the button for about 1/2 second, the BPM will go either to +16% for PITCH BEND+ or -16% for PITCH BEND-. If you tap the button, the BPM will only change a little so you can change the beat slightly without audible changing in the music.
- The CD will return to the tempo indicated by the Pitch slider when you release the PITCH BEND+ or -.
- Figure 11 shows an example of how to use the pitch bend function. In this example, both players are playing and the BPM has already been matched with the pitch sliders.



Figure 11-1

3) Turn the JOG dial

Turn the jog dial clockwise during play to increase the BPM in the forward direction, counterclockwise to decrease the BPM in the reverse direction. The faster you turn the wheel, the more BPM changes. The BPM changes with a range of +/-16%.

When you release jog wheel, the CD will return to the tempo indicated by the pitch slider.

12. Program play

- ❶ Press the PROGRAM button, the player will enter the program mode and the CD will stop rotating.
- ❷ Select the desired track by pressing the SKIP button, then press the PROGRAM button again. The selected track will be added to the program sequence.
- ❸ Repeat step 2 operation. A maximum of 30 tracks can be programmed at one time.
- ❹ Press the PLAY/PAUSE button to start the program play from the first selection.
- ❺ Press the program button again during program play to stop playing.
- ❻ Press and hold the program button more than 2 seconds to cancel the program mode and erase all the current program contents.

13. Loop Play (For audio CD only, will not work on graphics)

- ❶ Press the LOOP button to set the loop start point A, the LOOP indicator will flash on the LCD.
- ❷ Press the LOOP button again to set the loop end point B, after the B point is set, the playback will enter the loop play from A to B repeatedly.
- ❸ Press the LOOP button again, the loop play function is cancelled, the LOOP indicator goes out.

14. Add Video Connection

3 Ways To Hook-Up Video To Your T.V.

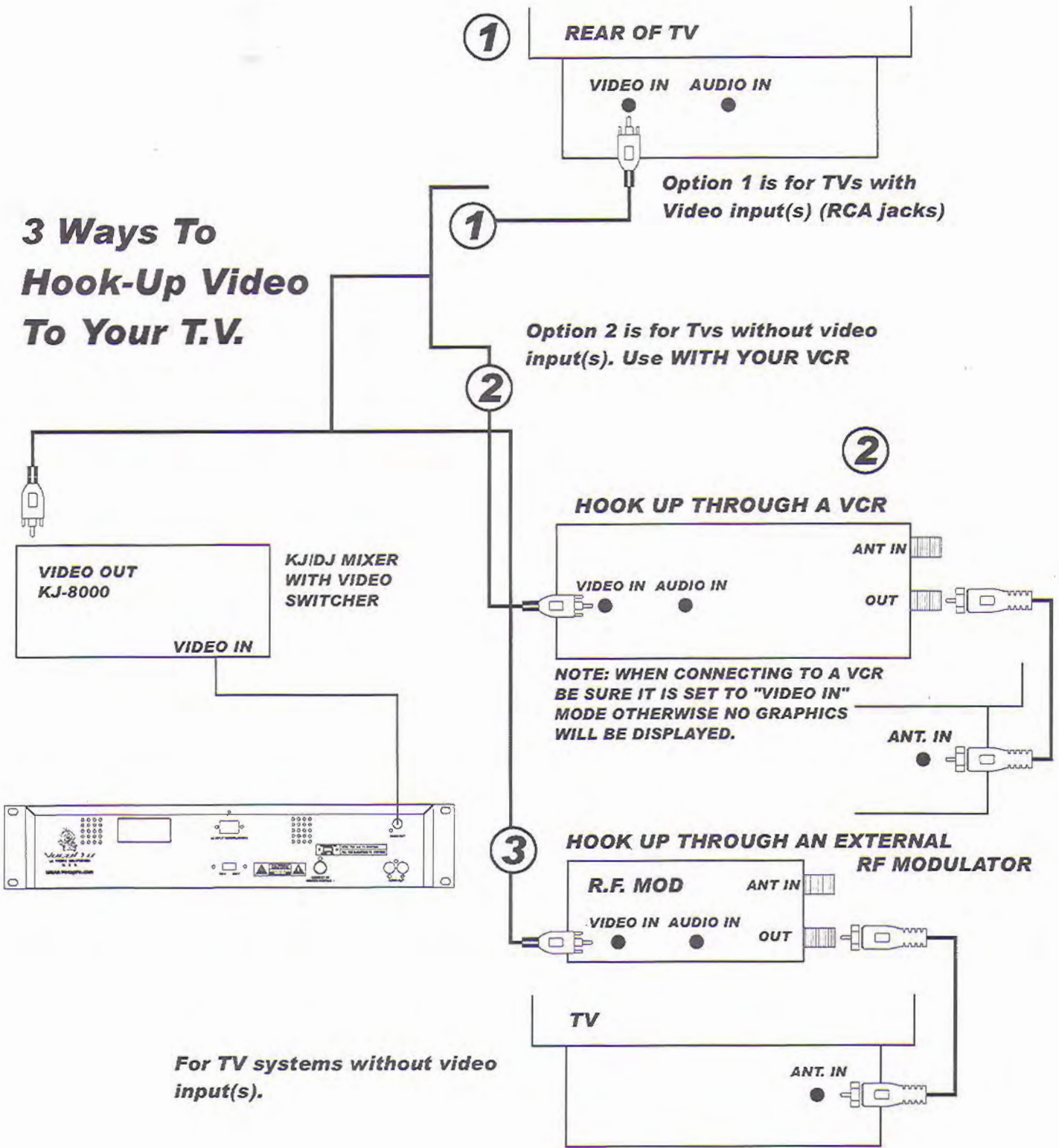

BEFORE SWITCHING OFF THE POWER

When you have finished using the CD player, before switching off the power, be sure that the disc holder has been closed with the OPEN/CLOSE button.

CAUTION:

Do not forcibly close the disc holder when the power is off.

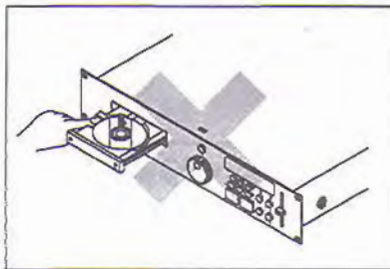

Do not switch off the power when the disc holder is open.

POWER OFF

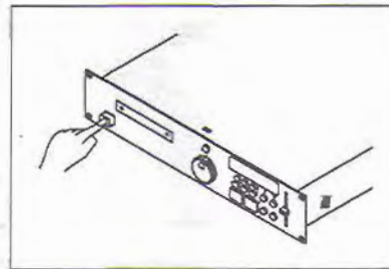

Switch off the power after the disc holder has been closed with the OPEN/CLOSE button.

POWER OFF

COMPACT DISCS

1. Precautions on handling compact discs

- Do not allow fingerprints, oil or dust to get on the surface of the disc.
- If the disc is dirty, wipe it off with a soft dry cloth.
- Do not use benzene, thinner, water, record spray, electrostatic-proof chemicals, or silicone-treated cloths to clean discs.
- Always handle discs carefully to prevent damaging the surface; in particular when removing a disc from its case or returning it.
- Do not bend the disc.
- Do not apply heat.
- Do not enlarge the hole in the center of the disc.
- Do not write on the CD (printed Side) with a hard-tipped pencil or ball point pen. Such implements will damage your CD and render the CD unusable.

- Condensation will form if a disc is brought into a warm area from a colder one, such as outdoors in winter. Do not attempt to dry the disc with a hair dryer, etc.

2. Precaution on storage

- After playing a disc, always unload it from the player.
- Always store the disc in the jewel case to protect from dirt or damage.
- Do not place discs in the following areas:
 - ① Areas exposed to direct sunlight for a considerable time.
 - ② Areas subject to accumulation of dust or high humidity.
 - ③ Areas affected by heat from indoor heaters, etc..

SPECIFICATIONS

GENERAL

Dimensions:	19"(W) x 3.5"(H) x 10.5"(D) in
Weight:	10 lbs.
Power supply:	115 / 230V AC, 50 / 60Hz
Power consumption:	14W

Free Manuals Download Website

<http://myh66.com>

<http://usermanuals.us>

<http://www.somanuals.com>

<http://www.4manuals.cc>

<http://www.manual-lib.com>

<http://www.404manual.com>

<http://www.luxmanual.com>

<http://aubethermostatmanual.com>

Golf course search by state

<http://golfingnear.com>

Email search by domain

<http://emailbydomain.com>

Auto manuals search

<http://auto.somanuals.com>

TV manuals search

<http://tv.somanuals.com>