

VocoPro[®]

PROFESSIONAL VOCAL SYSTEMS[™]

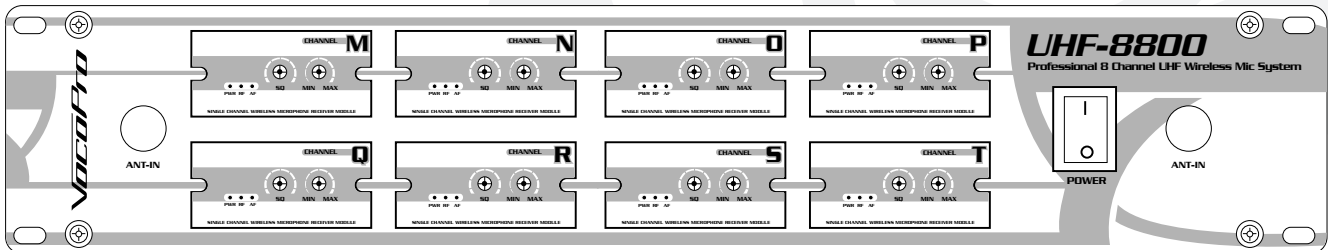
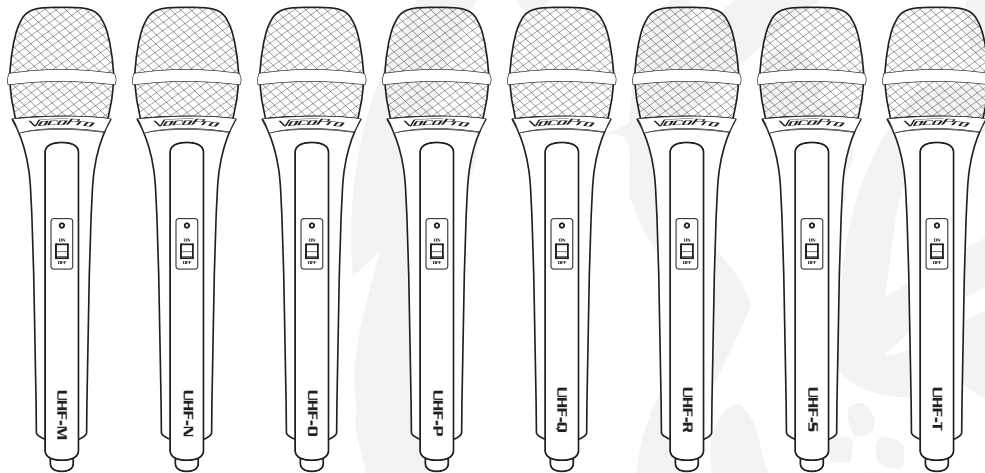

UHF-8800

8 Channel UHF Wireless Microphone System

o w n e r ' s m a n u a l

Table of Contents

| | |
|---------------------------------|----|
| FCC Information | 3 |
| Listening for a Lifetime..... | 4 |
| Safety Instructions..... | 5 |
| Welcome | 6 |
| Specifications | 7 |
| Getting Started | 8 |
| Microphone Basics..... | 9 |
| Mounting | 10 |
| Getting Connected..... | 11 |
| Descriptions and Functions..... | 12 |
| Maintenance Prodecures | 13 |
| Speaker Placement | 14 |
| Troubleshooting | 15 |

FCC Information

1. IMPORTANT NOTICE: DO NOT MODIFY THIS

UNIT!: This product, when installed as indicated in the instructions contained in this manual, meets FCC requirements. Modifications not expressly approved by Vocopro may void your authority, granted by the FCC, to use this product.

2. IMPORTANT: When connecting this product to accessories and/or another product use only high quality shielded cables. Cable(s) supplied with this product **MUST** be used. Follow all installation instructions. Failure to follow instructions could void your FCC authorization to use this product in the U.S.A.

3. NOTE: This product has been tested and found to comply with the requirements listed in FCC Regulations, Part 15 for Class "B" digital devices. Compliance with these requirements provides a reasonable level of assurances that your use of this product in a residential environment will not result in harmful interference with other electronic devices. This equipment generates/uses radio frequencies and, if not installed and used according to the instructions found in the owner's manual, may cause interference harmful to the operation of other electronic devices. Compliance with FCC regulations does not guarantee that interference will not occur in all installations. If this product is found to be the source of interference, which can be determined by turning the unit "Off" and "On", please try to eliminate the problem by using one of the following measures:

Relocate either this product or the device that is being affected by the interference.

Use power outlets that are on different branch (circuit breaker or fuse) circuits or install AC line filter(s).

In the case of radio or TV interference, relocate/reorient the antenna. If the antenna lead-in is 300-ohm ribbon lead, change the lead-in to coaxial type cable.

If these corrective measures do not produce satisfactory results, please contact your local retailer authorized to distribute Vocopro products. If you can not locate the appropriate retailer, please contact Vocopro, 1728 Curtiss Court, La Verne, CA 91750.

CAUTION

The apparatus is not disconnected from the AC power source so long as it is connected to the wall outlet, even if the apparatus itself is turned off. To fully ensure that the apparatus is indeed fully void of residual power, leave unit disconnected from the AC outlet for at least fifteen seconds.

CAUTION:

READ THIS BEFORE OPERATING YOUR UNIT

1. To ensure the finest performance, please read this manual carefully. Keep it in a safe place for future reference.
2. Install your unit in a cool, dry, clean place - away from windows, heat sources, and too much vibration, dust, moisture or cold. Avoid sources of hum (transformers, v motors). To prevent fire or electrical shock, do not expose to rain and water.
3. Do not operate the unit upside-down.
4. Never open the cabinet. If a foreign object drops into the set, contact your dealer.
5. Place the unit in a location with adequate air circulation. Do not interfere with its proper ventilation; this will cause the internal temperature to rise and may result in a failure.
6. Do not use force on switches, knobs or cords. When moving the unit, first turn the unit off. Then gently disconnect the power plug and the cords connecting to other equipment. Never pull the cord itself.
7. Do not attempt to clean the unit with chemical solvents: this might damage the finish. Use a clean, dry cloth.
8. Be sure to read the "Troubleshooting" section on common operating errors before concluding that your unit is faulty.
9. This unit consumes a fair amount of power even when the power switch is turned off. We recommend that you unplug the power cord from the wall outlet if the unit is not going to be used for a long time. This will save electricity and help prevent fire hazards. To disconnect the cord, pull it out by grasping the plug. Never pull the cord itself.
10. To prevent lightning damage, pull out the power cord and remove the antenna cable during an electrical storm.
11. The general digital signals may interfere with other equipment such as tuners or receivers. Move the system farther away from such equipment if interference is observed.

NOTE:

Please check the copyright laws in your country before recording from records, compact discs, radio, etc. Recording of copyrighted material may infringe copyright laws.

Voltage Selector (General Model Only)

Be sure to position the voltage selector to match the voltage of your local power lines before installing the unit.

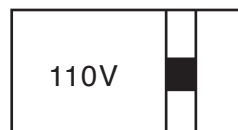

Listening for a Lifetime

Selecting fine audio equipment such as the unit you've just purchased is only the start of your musical enjoyment. Now it's time to consider how you can maximize the fun and excitement your equipment offers. VocoPro and the Electronic Industries Association's Consumer Electronics Group want you to get the most out of your equipment by playing it at a safe level. One that lets the sound come through loud and clear without annoying blaring or distortion and, most importantly, without affecting your sensitive hearing.

Sound can be deceiving. Over time your hearing "comfort level" adapts to a higher volume of sound. So what sounds "normal" can actually be loud and harmful to your hearing. Guard against this by setting your equipment at a safe level BEFORE your hearing adapts.

To establish a safe level:

- Start your volume control at a low setting.
- Slowly increase the sound until you can hear it comfortably and clearly, and without distortion.

Once you have established a comfortable sound level:

- Set the dial and leave it there.
- Pay attention to the different levels in various recordings.

Taking a minute to do this now will help to prevent hearing damage or loss in the future. After all, we want you listening for a lifetime.

Used wisely, your new sound equipment will provide a lifetime of fun and enjoyment. Since hearing damage from loud noise is often undetectable until it is too late, this manufacturer and the Electronic Industries Association's Consumer Electronics Group recommend you avoid prolonged exposure to excessive noise. This list of sound levels is included for your protection.

Some common decibel ranges:

| Level | Example |
|-----------|---|
| 30 | Quiet library, Soft whispers |
| 40 | Living room, Refrigerator, Bedroom away from traffic |
| 50 | Light traffic, Normal Conversation |
| 60 | Air Conditioner at 20 ft., Sewing machine |
| 70 | Vacuum cleaner, Hair dryer, Noisy Restaurant |
| 80 | Average city traffic, Garbage disposals, Alarm clock at 2 ft. |

The following noises can be dangerous under constant exposure:

| Level | Example |
|------------|---|
| 90 | Subway, Motorcycle, Truck traffic, Lawn Mower |
| 100 | Garbage truck, Chainsaw, Pneumatics drill |
| 120 | Rock band concert in front of speakers |
| 140 | Gunshot blast, Jet plane |
| 180 | Rocket launching pad |

-Information courtesy of the Deafness Research Foundation

Safety Instructions



CAUTION RISK OF SHOCK



CAUTION: To reduce the risk of electric shock, do not remove cover (or back). No user-serviceable parts inside. Only refer servicing to qualified service personnel.

Explanation of Graphical Symbols



The lightning flash & arrowhead symbol, within an equilateral triangle, is intended to alert you to the presence of danger.



The exclamation point within an equilateral triangle is intended to alert you to the presence of important operating and servicing instructions.

WARNING

To reduce the risk of fire or electric shock, do not expose this unit to rain or moisture.

- 1. Read Instructions** - All the safety and operating instructions should be read before the appliance is operated.
- 2. Retain Instructions** - The safety and operating instructions should be retained for future reference.
- 3. Heed Warnings** - All warnings on the appliance and in the operating instructions should be adhered to.
- 4. Follow Instructions** - All operating and use instructions should be followed.
- 5. Attachments** - Do not use attachments not recommended by the product manufacturer as they may cause hazards.
- 6. Water and Moisture** - Do not use this unit near water. For example, near a bathtub or in a wet basement and the like.
- 7. Carts and Stands** - The appliance should be used only with a cart or stand that is recommended by the manufacturer.
- 7 A.** An appliance and cart combination should be moved with care. Quick stops, excessive force, and uneven surfaces may cause an overturn.



8. Ventilation - The appliance should be situated so its location does not interfere with its proper ventilation. For example, the appliance should not be situated on a bed, sofa, rug, or similar surface that may block the ventilation slots.

9. Heat - The appliance should be situated away from heat sources such as radiators, heat registers, stoves, or other appliances (including amplifiers) that produce heat.

10. Power Sources - The appliance should be connected to a power supply only of the type described in the operating instructions or as marked on the appliance.

11. Grounding or Polarization - Precautions should be taken so that the grounding or polarization means of an appliance is not defeated.

12. Power-Cord Protection - Power-supply cords should be routed so that they are not likely to be walked on or pinched by items placed upon or against them, paying particular attention to cords at plugs, convenience receptacles, and the point where they exit from the appliance.

13. Cleaning - Unplug this unit from the wall outlet before cleaning. Do not use liquid cleaners or aerosol cleaners. Use a damp cloth for cleaning.

14. Power lines - An outdoor antenna should be located away from power lines.

15. Nonuse Periods - The power cord of the appliance should be unplugged from the outlet when left unused for a long period of time.

16. Object and Liquid Entry - Care should be taken so that objects do not fall and liquids are not spilled into the enclosure through openings.

17. Damage Requiring Service - The appliance should be serviced by qualified service personnel when:

- A. The power supply cord or plug has been damaged; or
- B. Objects have fallen into the appliance; or
- C. The appliance has been exposed to rain; or
- D. The appliance does not appear to operate normally or exhibits a marked change in performance; or
- E. The appliance has been dropped, or the enclosure damaged.

18. Servicing - The user should not attempt to service the appliance beyond that described in the operating instructions. All other servicing should be referred to qualified service personnel.

Note:

To CATV system installer's (U.S.A.): This reminder is provided to call the CATV system installer's attention to Article 820-40 of the NEC that provides guidelines for proper grounding and, in particular, specifies that the cable ground shall be connected as close to the point of cable entry as practical.



Welcome

And thank you for purchasing the **UHF-8800** from VocoPro, your ultimate choice in Karaoke entertainment! With years of experience in the music entertainment business, VocoPro is a leading manufacturer of Karaoke equipment, and has been providing patrons of bars, churches, schools, clubs and individual consumers the opportunity to sound like a star with full-scale club models, in-home systems and mobile units. All our products offer solid performance and sound reliability, and to reinforce our commitment to customer satisfaction, we have customer service and technical support professionals ready to assist you with your needs. We have provided some contact information for you below.

VocoPro

1728 Curtiss Court
La Verne, CA 91750
Toll Free: 800-678-5348
TEL: 909-593-8893
FAX: 909-593-8890

VocoPro Company Email Directory

Customer Service & General Information

info@vocopro.com

Tech Support

techsupport@vocopro.com

Remember Our Website

Be sure to visit the VocoPro website **www.vocopro.com** for the latest information on new products, packages and promos. And while you're there don't forget to check out our Club VocoPro for Karaoke news and events, chat rooms, club directories and even a KJ Service directory!

We look forward to hearing you sound like a PRO, with VocoPro, the singer's ultimate choice.

FOR YOUR RECORDS

Please record the model number and serial number below, for easy reference, in case of loss or theft. These numbers are located on the rear panel of the unit. Space is also provided for other relevant information

Model Number

Serial Number

Date of Purchase

Place of Purchase

Specifications

Receiver

Oscillation Mode: Quartz Controlled Fixed Frequency

Stability: 10 PPM

Sensitivity: 1.6 μ V @ sinad =12dB

Max. Deviation Range: 50Hz

S/N Ratio:>105dB

T.H.D.: <0.5% @ 1kHz

Image rejection: 85dB typical

Spurious Rejection: 75dB typical

Frequency Response: 40Hz~16kHz

Squelch Control: dual-squelch circuit

Max. Output Level: Balance: 0~400mV, Unbalance: 0~200mV

Power Supply: External DC Power Supply, 1.2A, 12~18V DC

Dimensions: 19"(L) x 3.5"(H) x 8.7"(D)

Transmitter (Handheld)

Transmitter Power: 30mV

Spurious Emission: <40dB(with carrier)

Battery Voltage: AA 1.5V*2

Battery Life: 12 hours

Getting Started

Thank you for purchasing the UHF-8800. Take a few moments to look through this manual. Before setting up, please make sure the following items are included.

- UHF-8800
- 8 Wireless Mics
- Carrying Case
- Power Adapter

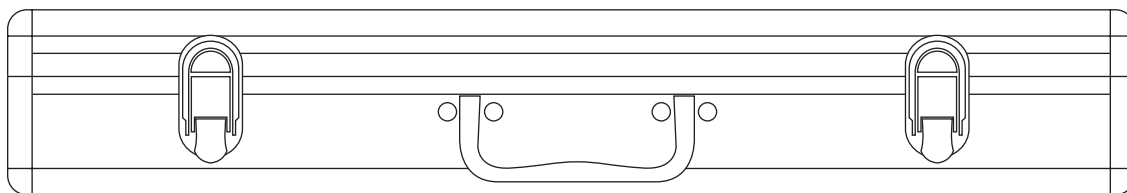
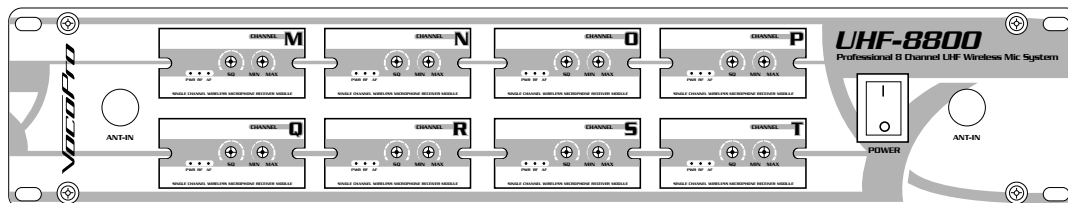
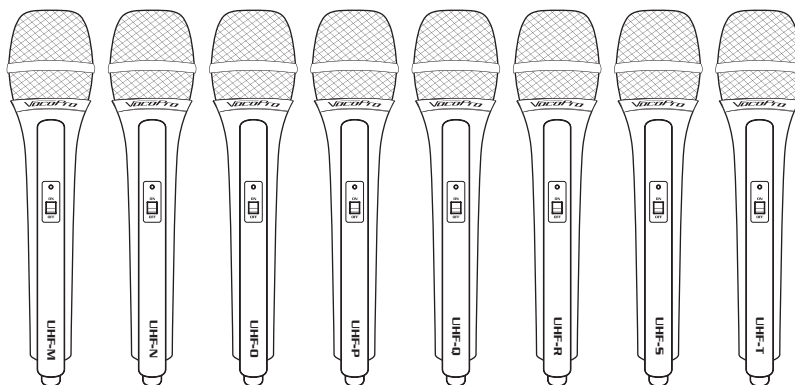

Returns and Warranty

In the unlikely event that the UHF-8800 would need to be shipped for repair, it is recommended that you keep all the product packaging and receipt. For detailed warranty information, please visit www.vocopro.com/warranty_extended.html. To find a VocoPro Authorized Service Center near you, please visit www.vocopro.com/servicecenter.html

Microphone Basics

Microphone Position

The UHF-8800 is ideal for close-up vocals and can be held in the hand or mounted on a mic stand. The most common applications and placement techniques are listed below. Keep in mind that microphone technique is largely a matter of personal taste, and there is no one "correct" microphone position.

Proximity Effect

When the sound source is less than $\frac{1}{4}$ in. from the microphone, the microphone boosts bass frequencies (by 6 to 10 dB at 100 Hz), creating a warmer and richer bass sound than when farther away. This effect, known as proximity effect, happens only in unidirectional dynamic microphones like the UHF-8800.

Feedback

Feedback occurs when the amplified sound from any loudspeaker reenters the sound system through any open microphone and is repeatedly amplified. Most commonly, feedback is caused by the following conditions: placing loudspeakers too close to microphones, having too many open active microphones, boosting tone controls indiscriminately (mainly treble) and performing in areas with high ratios of room surfaces that have hard and reflective surfaces such as glass, marble and wood. What to do if feedback occurs before the sound system is loud enough?

- Request that the talker speak louder into the microphone.
- Reduce the distance from the talker to the microphone. Each time this distance is halved, the sound system output will increase by 6dB.
- Reduce the number of open microphones.
- Move the loudspeaker farther away from the microphone. Each time this distance is doubled, the sound system output can be increased by 6dB.
- Move the loudspeaker closer to the listener.
- Use an equalizer/feedback reducer to cut the frequency bands in which the feedback occurs.

Microphone Placement & Tone Quality

Lead & Backup Vocals

Lips should be less than 3" from or even touching the windscreen on an axis to the microphone. Doing this creates a robust sound, emphasizes bass and provides maximum isolation from other sources.

Speech

When giving a speech or simply speaking, place the microphone 4" to 10" away from the mouth, just above nose height for a natural sound with reduced bass. You can also place the microphone 8" to 16" away from the mouth, slightly off to one side, for a more "distant" sound with highly reduced bass and minimal "s" sounds.

Mounting

To install the UHF-8800 to a 19" rack case, complete the steps below.

1. Align the UHF-8800 with the desired space in rack and slowly slide in, rear panel first.

NOTE: Depending on your rack case design, it may be necessary to allow for sufficient space for the antennas.

2. While aligned, use rack case screws (not included) in the order shown below to stabilize the UHF-8800 in its space, using the "X" rotation (numbered below) will ensure even tension and flush alignment.

NOTE: Do not tighten screws firmly until all screws are in place.

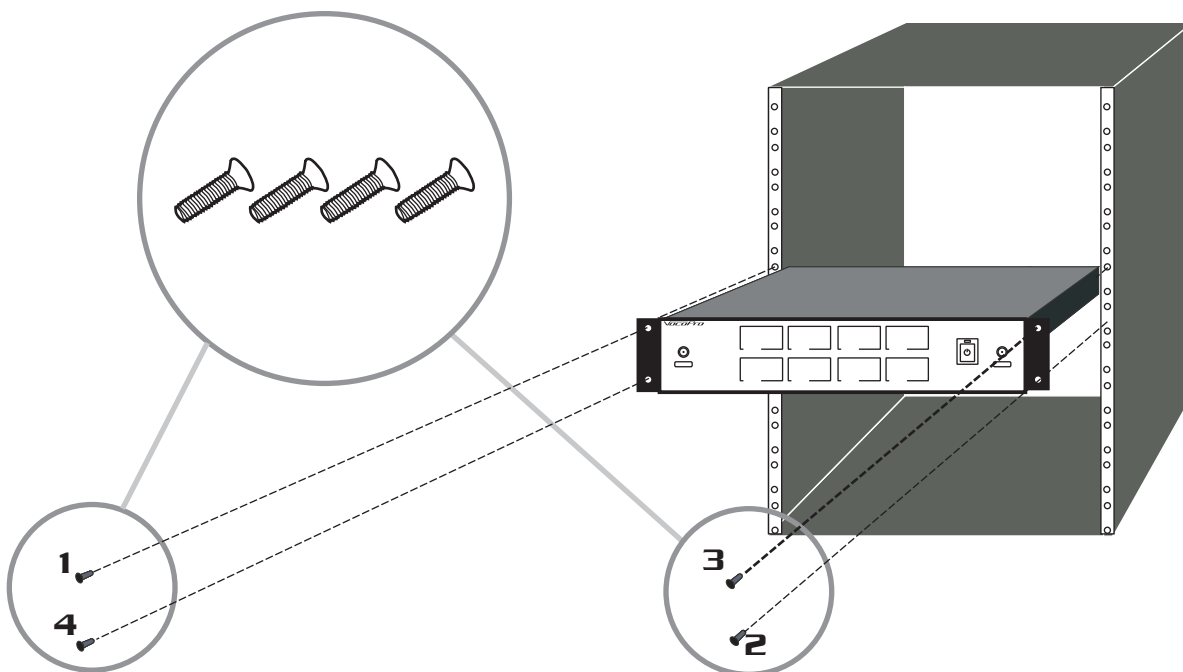

Getting Connected

System Connection

1. Connect the AC POWER ADAPTER to the UHF-8800 receiver's POWER INPUT connector, then plug the ADAPTER into a compatible AC electrical outlet.
2. Connect the UHF-8800's receiver to a sound system, mixer or amplifier's microphone input(s) with either two 1/4" output jack for a mixed channel output, or up to eight XLR output jacks for separate output for each mic.

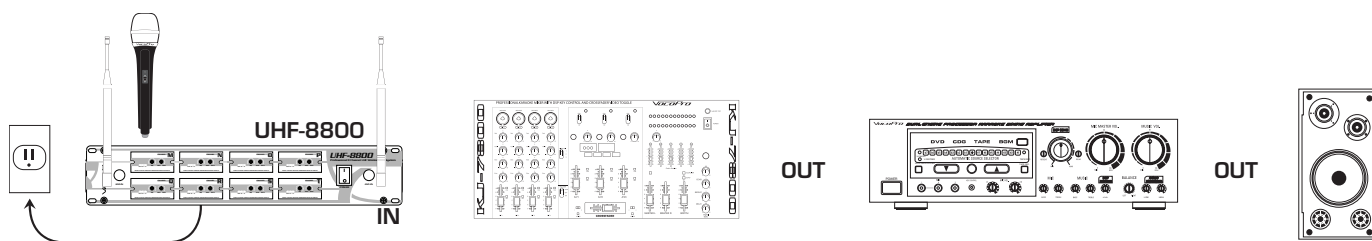

Deciding Between Mixed or Separate Output

Mixed Channel Output

Pro: Uses only 2 mic input on an external mixer/amplifier.

Con: External mic adjustments are only applied to all mic channels.

Separate Channel Output

Pro: External mic adjustments can be applied on one or all mic channels.

Con: Uses up to 8 mic inputs on mixer/amplifier.

Antenna Connection

Place antenna's TNC connector on the TNC jack and twist clockwise to fasten.

Descriptions and Functions

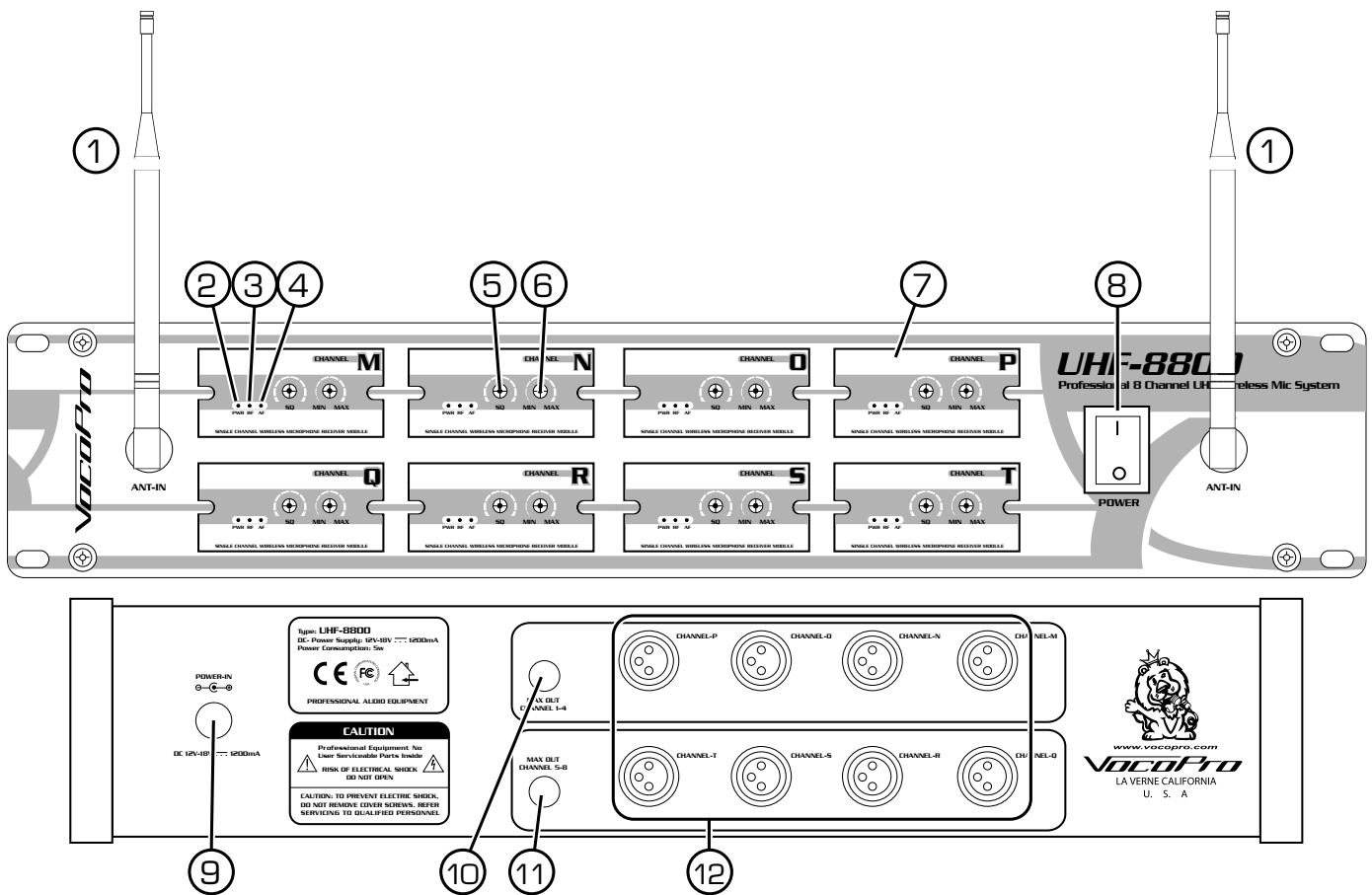

1. **ANTENNAS** - Provide both RF and AF signals.
2. **POWER (LED)** - Indicates whether the UHF-8800 is ON or OFF. When it is lit, the power is ON.
3. **RF (LED)** - Lights when RF signals are received from the microphone channels.
4. **AF (LED)** - Lights when AF signals are received from the microphone channels.
5. **SQUELCH controls** - Manual controls for controlling each microphone's signal strength for best performance. Turn clockwise to increase SQUELCH control and turn counter-clockwise to decrease SQUELCH application.
6. **VOLUME controls** - Adjusts the individual VOLUME of the receiver's 4 microphone channels.
7. **MICROPHONE modules** - Contains the SQUELCH and VOLUME controls for each of the 4 wireless microphones. Each module can be easily removed individually.
8. **POWER button** - Turns the UHF-8800 ON/OFF.
9. **AC POWER connection** - Main power jack for connection to an AC electrical outlet or power strip/surge protector.
10. **MIXED OUTPUT (1-4)** - This 1/4" unbalanced output jack is for output connection to amplifiers, effects devices or mixers. All mic channels are output through this jack for mixed output.
11. **MIXED OUTPUT (5-8)** - This 1/4" unbalanced output jack is for output connection to amplifiers, effects devices or mixers. All mic channels are output through this jack for mixed output.
12. **XLR AUDIO OUTS** - These XLR balanced output jacks are for output connections to amplifiers, effects devices or mixers. These are for separate mic channel connections with unmixed mic output.

Maintenance Procedures

Handheld Microphone Battery Installation

1. To remove the lid, press down on the tab and slide the lid down towards the bottom of the mic.
2. Insert 2 fresh 1.5-volt AA alkaline batteries. Make sure the batteries are inserted in the right direction according to polarity (+/-).
3. Close the BATTERY COMPARTMENT lid.

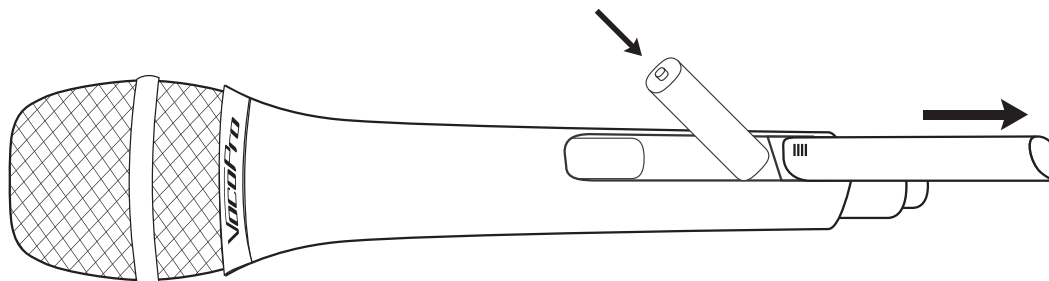

Removing the Field Replaceable Modules

Each of the 8 microphone modules on the UFH-8800 were designed in a way that allows them to slide out without the need for any special tools. This is a convenient feature if ever a module needs to be repaired or replaced.

Although tools are not necessary it might be helpful to use a flat-head screwdriver to nudge the module out of its compartment.

1. To remove, simply slide the module out of the compartment
2. To re-insert, slide the module into compartment until it is completely secured

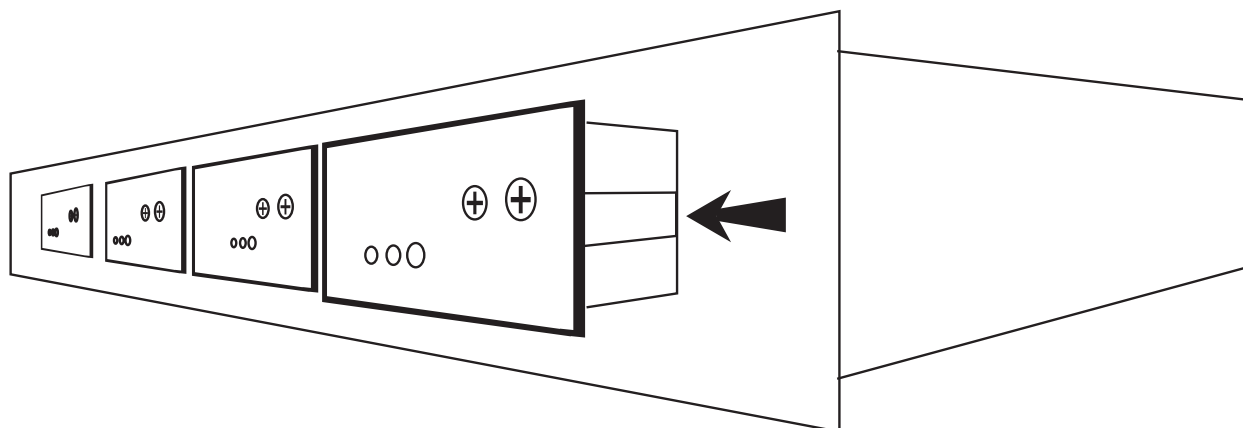

UHF-8800 & stage monitor/p.a. loudspeakers

If you will be using the UHF-8800 with stage monitors and/or P.A. system, try the following:

- Place the stage monitor directly behind the microphone.
- Locate the P.A. loudspeakers so that they point away from the rear of the microphone. (With the speakers located in these positions, the possibility of feedback is greatly reduced).
- Always check the stage setup before a performance to ensure optimum placement of microphone and monitors.

IMPORTANT: Every wireless microphone installation is a unique situation, and can present a variety of problems. Never attempt a live performance without first conducting a “walkthrough” test of the system in the performing area. If major changes (additional wireless systems or intercoms, relocation of scenery, etc.) have been made since the last walk-through test, check the wireless system again, as close to performance time as possible.

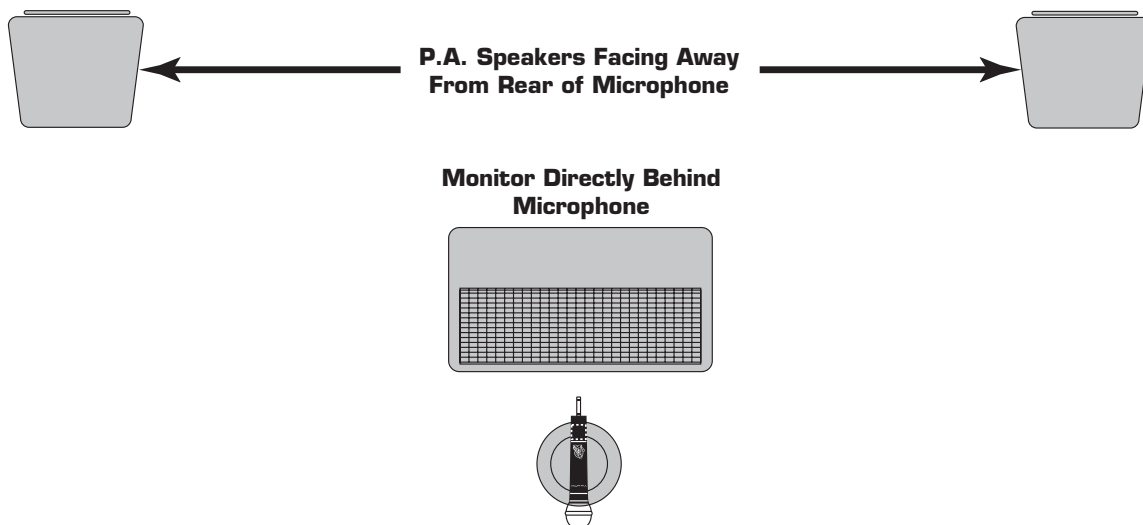

Operations

1. Press the POWER button on the UHF-8800 receiver's front panel.
2. Adjust the receiver's VOLUME controls to approximately 50%.
3. Switch the microphone's POWER BUTTONS to the ON positions.
4. Talk or sing into the microphones. During normal operation, the RF/AF signal LED's will light when a microphone is being used.
5. Adjust the receiver's VOLUME controls until the output levels are balanced with each other and other possible source output i.e. CD+G tracks.

Troubleshooting

| Problems | Solutions |
|--|--|
| No sound output, RF/AF LED(s) are not glowing | <ul style="list-style-type: none">• Make sure the microphone and receiver power switches and receiver are set to the ON position.• Check microphone batteries to ensure that they are providing sufficient power. Replace battery if necessary.• Check receiver's AC power connection.• Make sure antennas are firmly connected and extended to an optimal position.• If necessary, reduce the distance between the microphones and receiver.• Turn up the receiver's VOLUME level controls.• Check for proper connection between receiver and external amplifier/mixer.• Talk into the microphone and observe the receiver's RF/AF signal LED's. If they glow, the problem is elsewhere in the sound system. |
| Received signal is noisy or contains extraneous sounds with the microphone(s) ON. | <ul style="list-style-type: none">• Check microphone(s) batteries and replace if the charge is low.• Remove local sources of UHF interference, such as lighting equipment.• Adjust the squelch controls on the front of the UHF-8800 receiver.• Signal may be too weak. If so, reposition antennas. (If possible, move them closer to the transmitter). |
| There is noise coming from the receiver with the microphones turned OFF. | <ul style="list-style-type: none">• Remove local sources of UHF interference, such as lighting equipment.• Reposition the receiver or antennas. |
| Momentary loss of sound as microphone(s) are moved throughout the operating range. | <ul style="list-style-type: none">• Reposition the receiver, perform a "walkthrough", and observe the signal strengths. If audio dropouts persist, mark these "dead spots" in the operating area and avoid them during the performance. |

VocoPro[®]

PROFESSIONAL VOCAL SYSTEMS[™]



UHF-8800 Owner's Manual
© VocoPro 2009
v1.0
www.vocopro.com

Free Manuals Download Website

<http://myh66.com>

<http://usermanuals.us>

<http://www.somanuals.com>

<http://www.4manuals.cc>

<http://www.manual-lib.com>

<http://www.404manual.com>

<http://www.luxmanual.com>

<http://aubethermostatmanual.com>

Golf course search by state

<http://golfingnear.com>

Email search by domain

<http://emailbydomain.com>

Auto manuals search

<http://auto.somanuals.com>

TV manuals search

<http://tv.somanuals.com>