

# VocoPro

ULTIMATE CHOICE OF KARAOKE ENTERTAINMENT

owner's manual

## HIGH DEFINITIVE SOUND

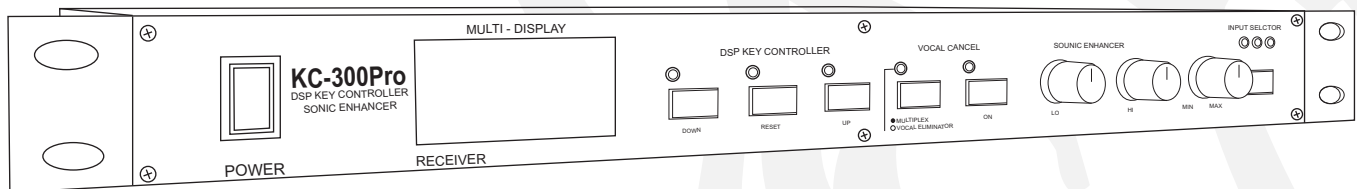

# KC-300Pro

DSP KEY CONTROLLER/SONIC ENHANCER

# Safety Instructions



## CAUTION

### RISK OF SHOCK



CAUTION: To reduce the risk of electric shock, do not remove cover (or back). No user-serviceable parts inside. Only refer servicing to qualified service personnel.

## Explanation of Graphical Symbols



The lightning flash & arrowhead symbol, within an equilateral triangle, is intended to alert you to the presence of danger.



The exclamation point within an equilateral triangle is intended to alert you to the presence of important operating and servicing instructions.

## WARNING

To reduce the risk of fire or electric shock, do not expose this unit to rain or moisture.

**1. Read Instructions** - All the safety and operating instructions should be read before the appliance is operated.

**2. Retain Instructions** - The safety and operating instructions should be retained for future reference.

**3. Heed Warnings** - All warnings on the appliance and in the operating instructions should be adhered to.

**4. Follow Instructions** - All operating and use instructions should be followed.

**5. Attachments** - Do not use attachments not recommended by the product manufacturer as they may cause hazards.

**6. Water and Moisture** - Do not use this unit near water. For example, near a bathtub or in a wet basement and the like.

**7. Carts and Stands** - The appliance should be used only with a cart or stand that is recommended by the manufacturer.

**7 A.** An appliance and cart combination should be moved with care. Quick stops, excessive force, and uneven surfaces may cause an overturn.



**8. Ventilation** - The appliance should be situated so its location does not interfere with its proper ventilation. For example, the appliance should not be situated on a bed, sofa, rug, or similar surface that may block the ventilation slots.

**9. Heat** - The appliance should be situated away from heat sources such as radiators, heat registers, stoves, or other appliances (including amplifiers) that produce heat.

**10. Power Sources** - The appliance should be connected to a power supply only of the type described in the operating instructions or as marked on the appliance.

**11. Grounding or Polarization** - Precautions should be taken so that the grounding or polarization means of an appliance is not defeated.

**12. Power-Cord Protection** - Power-supply cords should be routed so that they are not likely to be walked on or pinched by items placed upon or against them, paying particular attention to cords at plugs, convenience receptacles, and the point where they exit from the appliance.

**13. Cleaning** - Unplug this unit from the wall outlet before cleaning. Do not use liquid cleaners or aerosol cleaners. Use a damp cloth for cleaning.

**14. Power lines** - An outdoor antenna should be located away from power lines.

**15. Nonuse Periods** - The power cord of the appliance should be unplugged from the outlet when left unused for a long period of time.

**16. Object and Liquid Entry** - Care should be taken so that objects do not fall and liquids are not spilled into the enclosure through openings.

**17. Damage Requiring Service** - The appliance should be serviced by qualified service personnel when:

- A. The power supply cord or plug has been damaged; or
- B. Objects have fallen into the appliance; or
- C. The appliance has been exposed to rain; or
- D. The appliance does not appear to operate normally or exhibits a marked change in performance; or
- E. The appliance has been dropped, or the enclosure damaged.

**18. Servicing** - The user should not attempt to service the appliance beyond that described in the operating instructions. All other servicing should be referred to qualified service personnel.

### Note:

To CATV system installer's (U.S.A.): This reminder is provided to call the CATV system installer's attention to Article 820-40 of the NEC that provides guidelines for proper grounding and, in particular, specifies that the cable ground shall be connected as close to the point of cable entry as practical.

# CAUTION: Read this before operating your unit

---

## CAUTION

The apparatus is not disconnected from the AC power source so long as it is connected to the wall outlet, even if the apparatus itself is turned off. To fully insure that the apparatus is indeed fully void of residual power, leave unit disconnected from the AC outlet for at least fifteen seconds.

1. To ensure the finest performance, please read this manual carefully. Keep it in a safe place for future reference.
2. Install your unit in a cool, dry, clean place – away from windows, heat sources, and too much vibration, dust, moisture or cold. Avoid sources of hum (transformers, motors). To prevent fire or electrical shock, do not expose to rain and water.
3. Do not operate the unit upside-down.
4. Never open the cabinet. If a foreign object drops into the set, contact your dealer.
5. Place the unit in a location with adequate air circulation. Do not interfere with its proper ventilation; this will cause the internal temperature to rise and may result in a failure.
6. Do not use force on switches, knobs or cords. When moving the unit, first turn the unit off. Then gently disconnect the power plug and the cords connecting to other equipment. Never pull the cord itself.
7. Do not attempt to clean the unit with chemical solvents: this might damage the finish. Use a clean, dry cloth.
8. Be sure to read the “Troubleshooting” section on common operating errors before concluding that your unit is faulty.
9. This unit consumes a fair amount of power even when the power switch is turned off. We recommend that you unplug the power cord from the wall outlet if the unit is not going to be used for a long time. This will save electricity and help prevent fire hazards. To disconnect the cord, pull it out by grasping the plug. Never pull the cord itself.
10. To prevent lightning damage, pull out the power cord and remove the antenna cable during an electrical storm.
11. The general digital signals may interfere with other equipment such as tuners or receivers. Move the system farther away from such equipment if interference is observed.
12. When positioning your equipment, especially regarding speakers or other accessories, avoid positioning them over areas where they can fall and cause injury to yourself and others.

### Note:

Please check the copyright laws in your country before recording from records, compact discs, radio, etc. Recording of copyrighted material may infringe copyright laws.



# Welcome....

And Thank you for purchasing the **KC-300Pro** from VocoPro, your ultimate choice in Karaoke entertainment! With years of experience in the music entertainment business,

VocoPro is a leading manufacturer of Karaoke equipment, and has been providing patrons of bars, churches, schools, clubs and individual consumers the opportunity to sound like a star with full-scale club models, in-home systems and mobile units. All our products offer solid performance and sound reliability, and to further strengthen our commitment to customer satisfaction, we have customer service and technical support professionals ready to assist you with your needs. We have provided some contact information for you below.

**VocoPro**

1728 Curtiss Court  
La Verne, CA 91750

**Toll Free: 800-678-5348**

TEL: 909-593-8893

FAX: 909-593-8890

**VocoPro Company Email Directory**

**Customer Service & General Information**

info@vocopro.com

**Tech Support**

techsupport@vocopro.com

**Remember Our Website**

Be sure to visit the VocoPro website [www.vocopro.com](http://www.vocopro.com) for the latest information on new products, packages and promo's. And while you're there don't forget to check out our Club VocoPro for Karaoke news and events, chat rooms, club directories and even a Service directory!

We look forward to hearing you sound like a PRO, with VocoPro, your ultimate choice in Karaoke entertainment.

## FOR YOUR RECORDS

Please record the model number and serial number below, for easy reference, in case of loss or theft. These numbers are located on the rear panel of the unit. Space is also provided for other relevant information

**Model Number** \_\_\_\_\_

**Serial Number** \_\_\_\_\_

**Date of Purchase** \_\_\_\_\_

**Place of Purchase** \_\_\_\_\_

# Listening For A Lifetime

---

Selecting fine audio equipment such as the unit you've just purchased is only the start of your musical enjoyment. Now it's time to consider how you can maximize the fun and excitement your equipment offers. VocoPro and the Electronic Industries Association's Consumer Electronics Group want you to get the most out of your equipment by playing it at a safe level. One that lets the sound come through loud and clear without annoying blaring or distortion and, most importantly, without affecting your sensitive hearing.

Sound can be deceiving. Over time your hearing "comfort level" adapts to a higher volume of sound. So what sounds "normal" can actually be loud and harmful to your hearing. Guard against this by setting your equipment at a safe level BEFORE your hearing adapts.

To establish a safe level:

- Start your volume control at a low setting.
- Slowly increase the sound until you can hear it comfortably and clearly, and without distortion.

Once you have established a comfortable sound level:

- Set the dial and leave it there.
- Pay attention to the different levels in various recordings.

Taking a minute to do this now will help to prevent hearing damage or loss in the future. After all, we want you listening for a lifetime.

Used wisely, your new sound equipment will provide a lifetime of fun and enjoyment. Since hearing damage from loud noise is often undetectable until it is too late, this manufacturer and the Electronic Industries Association's Consumer Electronics Group recommend you avoid prolonged exposure to excessive noise. This list of sound levels is included for your protection.

## Some common decibel ranges:

Level	Example
<b>30</b>	Quiet library, Soft whispers
<b>40</b>	Living room, Refrigerator, Bedroom away from traffic
<b>50</b>	Light traffic, Normal Conversation
<b>60</b>	Air Conditioner at 20 ft., Sewing machine
<b>70</b>	Vacuum cleaner, Hair dryer, Noisy Restaurant
<b>80</b>	Average city traffic, Garbage disposals, Alarm clock at 2 ft.

## The following noises can be dangerous under constant exposure:

Level	Example
<b>90</b>	Subway, Motorcycle, Truck traffic, Lawn Mower
<b>100</b>	Garbage truck, Chainsaw, Pneumatics drill
<b>120</b>	Rock band concert in front of speakers
<b>140</b>	Gunshot blast, Jet plane
<b>180</b>	Rocket launching pad

-Information courtesy of the Deafness Research Foundation

# KC-300Pro

DSP KEY CONTROLLER/SONIC ENHANCER

---

## Contents

Cautions and Warnings . . . . .	2-3
Welcome . . . . .	4
Listening for a Lifetime . . . . .	5
Features . . . . .	7
Specifications . . . . .	7
Before Getting Started . . . . .	8
Front Panel Description and Functions . . . . .	9
Rear Panel Description and Functions . . . . .	10
Remote Control Descriptions and Functions . . . . .	11
Rack Mounting. . . . .	12
Getting Connected. . . . .	13-14
Advanced Operation . . . . .	15
Troubleshooting . . . . .	16
Glossary . . . . .	17-18
Recommended Gear . . . . .	19-22



# The KC-300Pro's Features

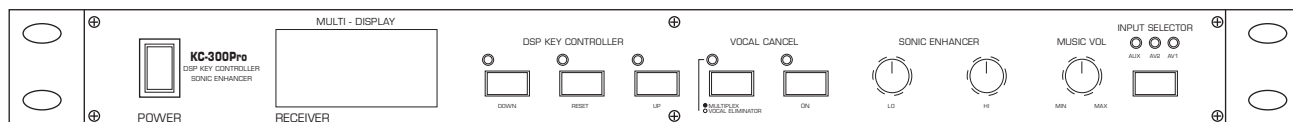

- 17-Step DSP Key Controller
- Vocal Cancel to Remove Vocals from Multiplex Karaoke Software
- Vocal Eliminator to Eliminate Vocals from Standard CD's
- Sonic Enhancer Optimizes High/Low Frequencies for a Full and Rich Sound
- Full-Function Remote Control
- Large Multi-Display for Easy Viewing in Low-Light Situations
- Super Slim 1RU design
- Inputs: 3 Audio (2 RCA, 1 XLR) 2 Video (RCA)
- Outputs: 2 Audio (1 RCA, 1 XLR), 2 Video (RCA)
- 115V-230V Switchable

## Specifications

Input Sensitivity/Impedance .....	200mV/22k Ohm (balanced/unbalanced)
Maximum Output .....	AC 10 Vrms/220 Ohm (balanced/unbalanced)
Maximum Response Range (ALL) .....	>17dB
S/N Ratio (Effects Off) .....	>95dB (Muting OFF) AV1/AV2/AUX
Key Control S/N Ratio (Effect OFF) .....	>80dB
Vocal Eliminator Center Frequency .....	1300Hz
Effect Center Frequency.....	Low 80Hz +8dB (Max) High 12KHz +8dB (Max)
Key Control System .....	Variable (IN-SIDE Key Control AUTO-RESET SWITCH SELECT)
Key Control Range .....	+/- 8 Key (Each step 75 cents)
Key Reset Time .....	3 Second (Audio Detect L+R)
Volume Muting .....	>95dB
Dimensions .....	19" (W) x 1.75" (H) x 13" (D)
Net Weight .....	22 Lbs. (Including box)
Power Voltage Requirement .....	120V (Fuse 2A)/240V (Fuse 1A) Variable
Power Consumption .....	18W
Remote Control .....	2 AA Batteries
Accessories .....	Remote Control and Instruction Manual

## **Before Getting Started:** Things to Consider

---

It is very important to read the following instructions prior to starting any installation procedures. Doing so will ensure a correct installation and may save you some time as well.

### **Protect Against Power Surges**

- Connect all external components before you plug any of their power cords into the wall outlet.
- Turn off the KC-300Pro before you connect or disconnect any cables.
- Make sure all cables are properly grounded.

### **Protect Components from Overheating**

- Don't block ventilation holes. Arrange any components so that air can circulate freely.
- Don't stack components.
- If you place the KC-300Pro on a stand, make sure you allow adequate ventilation.

### **Position Cables Properly to Avoid Audio Interference**

- Insert each cable firmly into the designated jack.
- If you place components above the KC-300Pro, route all cables down the side of the back of the KC-300Pro instead of straight down the middle of the back of the KC-300Pro.

### **Important Stand and Base Safety Information**

Choose the location for your KC-300Pro carefully. If the KC-300Pro is placed on a stand or base, ensure that it is of adequate size and strength to prevent it from being accidentally tipped over, pushed off, or pulled off. This could cause personal injury and/or damage to the KC-300Pro.

### **Use Indirect Light**

Don't place the KC-300Pro where sunlight or room lighting will be directed toward the screen. Use soft or indirect lighting.



# Front Panel Descriptions

---

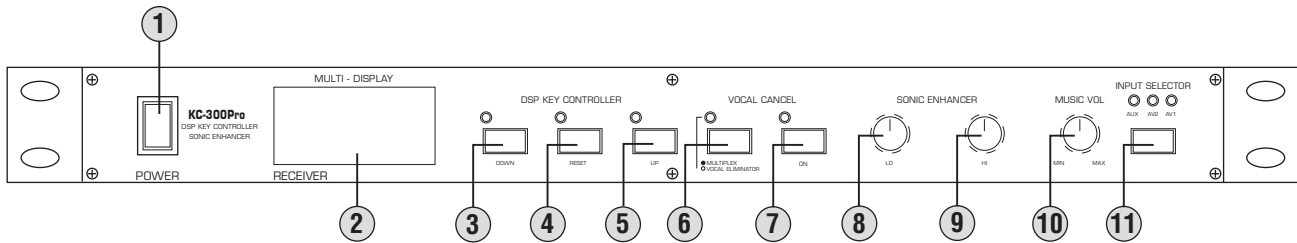

- 1. POWER button** – Turns the unit ON/OFF.
- 2. MULTI-DISPLAY panel** – Displays numeric values of the units OPERATING STATUS.
- 3. DOWN button** – Lowers the MUSICAL KEY a half step each time it is pressed.
- 4. RESET button** – Resets the MUSICAL KEY back to it's original key.
- 5. UP button** – Raises the MUSICAL KEY a half step each time it is pressed.
- 6. MULTIPLEX button** – Selects between VOCAL CANCEL and VOCAL ELIMINATOR features. Also used to disable a Vocal feature.
- 7. ON button** – Turns the SONIC ENHANCER ON/OFF.
- 8. LOW knob** – Adjusts the levels of LOW FREQUENCY ENHANCEMENT made by the SONIC ENHANCER. Turn clockwise to INCREASE and counter-clockwise to DECREASE.
- 9. HIGH knob** – Adjusts the levels of HIGH FREQUENCY ENHANCEMENT made by the SONIC ENHANCER. Turn clockwise to INCREASE and counter-clockwise to DECREASE.
- 10. MUSIC knob** – Increases and decreases the MASTER VOLUME. Turn clockwise to INCREASE and counter-clockwise to DECREASE.
- 11. INPUT SELECTOR button** – Cycles through the A/V1, A/V2 and AUX input channels.

# Rear Panel Descriptions

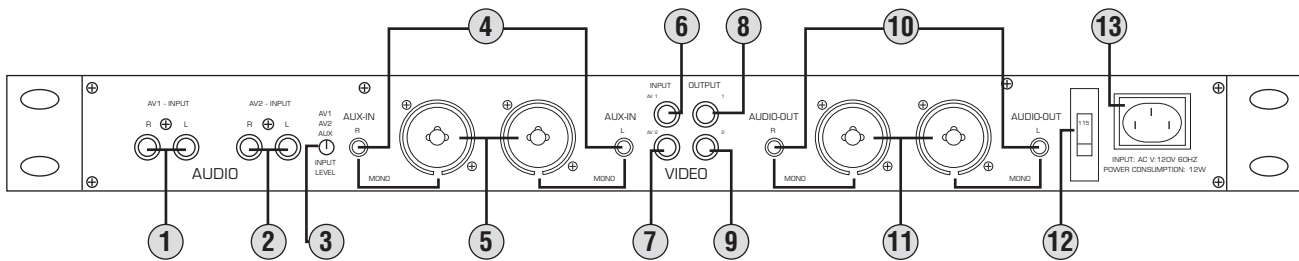

**1. A/V 1 AUDIO IN jacks (RCA)** – Receives audio output from a device on A/V 1 channel. Connect a paired RCA audio cable from these jacks to the AUDIO OUTPUT jacks on A/V device 1.

**2. A/V 2 AUDIO IN jacks (RCA)** – Receives audio output from a device on A/V 2 channel. Connect a paired RCA audio cable from these jacks to the AUDIO OUTPUT jacks on A/V device 2.

**3. INPUT LEVEL control** – Adjusts the INPUT LEVEL from the device connected to the AV1 AV2 and AUX channel. Turn clockwise to increase and counter-clockwise to decrease.

**4. AUX AUDIO IN jacks (RCA)** – Receives audio output from a device on AUX channel. Connect a paired RCA audio cable from these jacks to the AUDIO OUTPUT jacks on AUX device.

**5. AUX AUDIO IN jacks (XLR)** – Receives audio output from a device on the AUX channel. Connect a pair of XLR audio cables from these jacks to the AUDIO OUTPUT jacks on the AUX device.

**6. A/V 1 VIDEO IN jack (RCA)** – Receives video output from a device on A/V 1 channel. Connect a RCA video cable from this jack to the VIDEO OUTPUT jack on A/V 1 device.

**7. A/V 2 VIDEO IN jack (RCA)** – Receives video output from a device on A/V 2 channel. Connect a RCA video jack cable from this jack to the VIDEO OUTPUT jack on A/V 2 device.

**8. A/V 1 VIDEO OUT jack (RCA)** – Sends video output to a primary TV or display device. Connect an RCA video cable from this jack to your TV'S VIDEO INPUT JACK.

**9. A/V 2 VIDEO OUT jack (RCA)** – Sends video output to a secondary TV or display device. Connect an RCA video cable from this jack to your TV'S VIDEO INPUT JACK.

**10. AUDIO OUT jacks (RCA)** – Sends audio output to an amplifier, mixer or recorder. Connect a paired RCA audio cable from these jacks to the AUDIO INPUT jacks of an amplifier, mixer or recording device.

**11. AUDIO OUT jacks (XLR)** – Sends audio output to an amplifier, mixer or recorder. Connect a pair of XLR audio cables from these jacks to the AUDIO INPUT jacks of an amplifier, mixer or recording device.

**Note:** The RCA and the XLR audio output jacks can be used simultaneously. For example, you can have an amplifier connected to the XLR audio output jacks and a recording device connected to the RCA audio output jacks at the same time.

**12. VOLTAGE SELECTOR** – Toggles between 115V and 230V VOLTAGE SETTINGS.

**13. AC~IN terminal** – Connects the AC POWER CORD from the wall outlet.

# Remote Control Descriptions and Functions

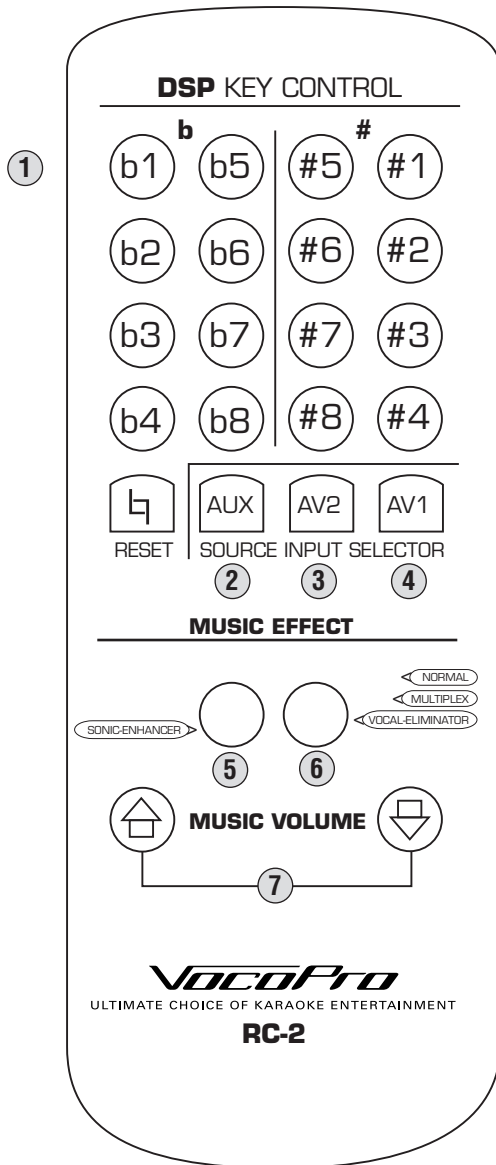

- DSP KEY CONTROL buttons** – DIRECT ACCESS buttons to any of the DSP Key Controllers 17 Steps.
- AUX button** – Selects the device connected to the AUX channel as the current INPUT SOURCE.
- AV2 button** – Selects the device connected to the AV2 channel as the current INPUT SOURCE.
- AV1 button** – Selects the device connected to the AV1 channel as the current INPUT SOURCE.
- SONIC ENHANCER button** – Turns the SONIC ENHANCER feature ON/OFF.
- MULTI-AUDIO button** – Selects through VOCAL CANCEL, VOCAL ELIMINATOR and no vocal mode.
- MUSIC VOLUME buttons** – Raises and lowers the MASTER MUSIC VOLUME.

# Rack Mounting

## Tools required:

- Phillips Screwdriver (not included)
- 7 Bracket Screws (included) (if rack mounting)
- 2 Mounting Brackets (included) (if rack mounting)
- 19" Rack Case (not included)

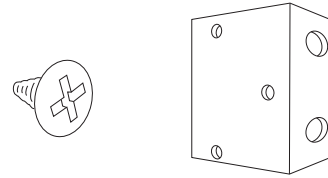

For mounting versatility, the KC-300Pro can be installed as a stand alone component in a home entertainment system or mounted to a compatible rack case via the included mounting brackets.

## To install to a pre-existing entertainment system:

1. Place unit in desired space and make appropriate connections.

## To install unit to a rack case, complete the steps below:

1. Attach mounting brackets to the KC-300Pro with the mounting screws provided.  
(There is one bracket for each side).

Left side Mounting Bracket

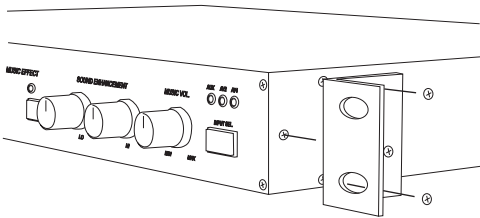

Right side Mounting Bracket w/screws

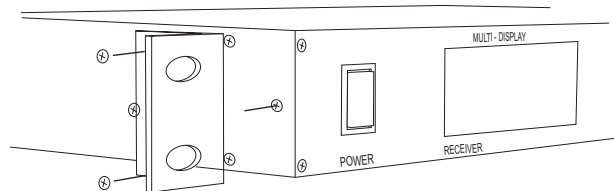

## Required: 1 RU of Rack Space

## To install unit to a rack case, complete the steps below.

1. Align the KC-300Pro with desired space in rack and slide in slowly, rear panel first.

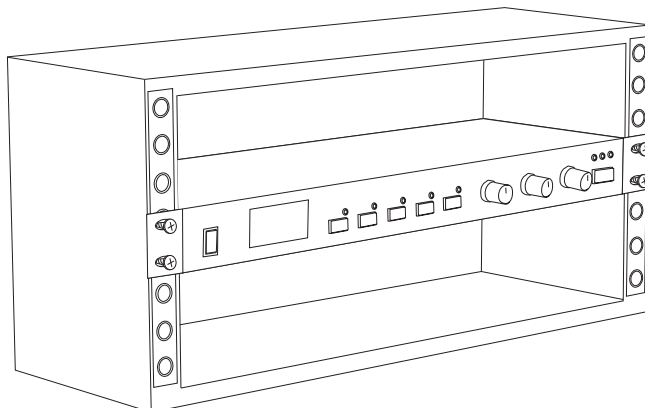
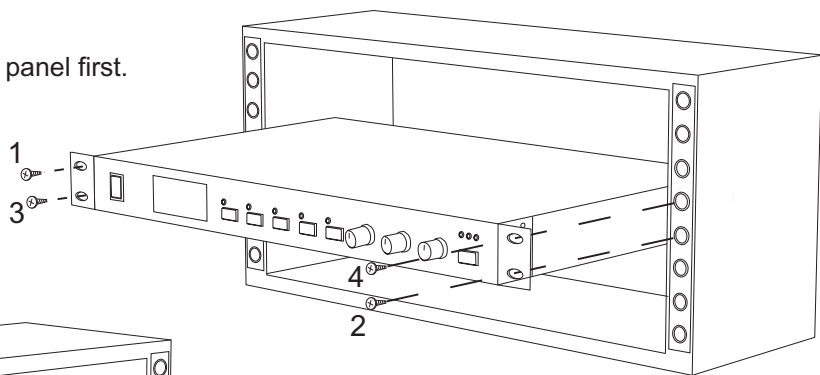

2. While aligned, use rack case screws (not included) in the order shown in the diagram to stabilize the KC-300Pro in its space. Using the "X" rotation (numbered above) will ensure even tension and push alignment.

**Note:** Do not firmly tighten the screws until all the screws are in place.

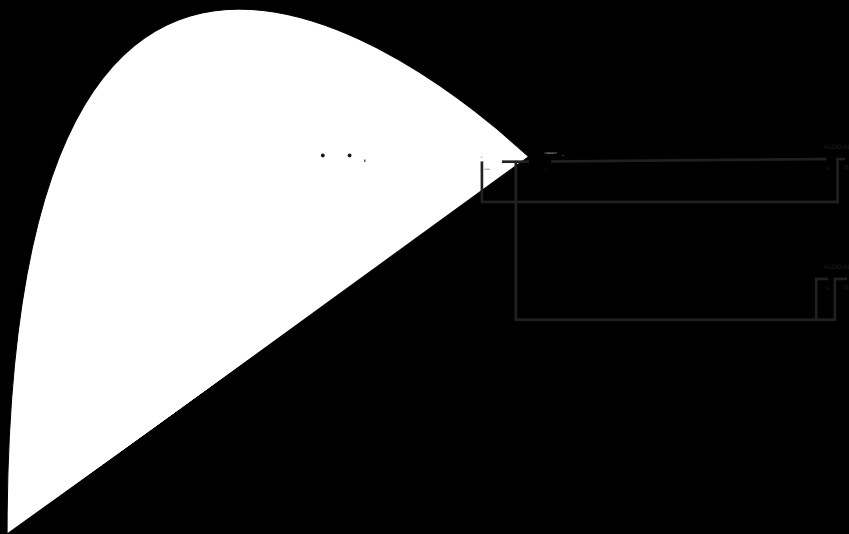

# Getting Connected

## Connecting a Video Cable to the TV

The KC-300Pro has two VIDEO OUTPUT jacks.

(a) Connect an RCA video cable from the desired VIDEO OUTPUT jack on the KC-300Pro to the VIDEO INPUT jack on the TV. Some TV's will require that you manually switch the TV to the VIDEO INPUT mode. Other TV's will automatically switch to the video mode when they detect a video signal at the video input jack. On most TV's the jack is labeled AUX or VIDEO.

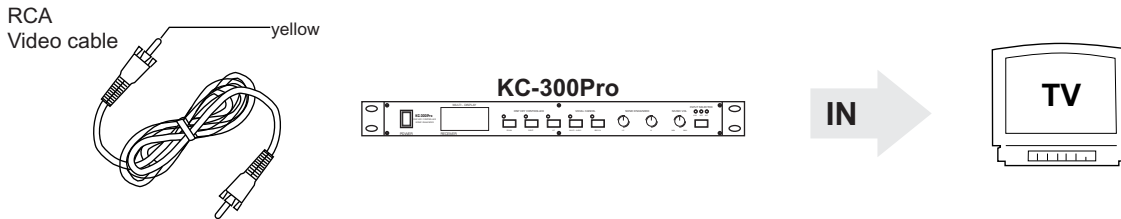

(b) If the TV does not have a VIDEO INPUT jack you may connect that end of the cable to the VIDEO INPUT of a VCR and connect the RF OUTPUT of the VCR to the TV ANTENNA INPUT jack on your TV.

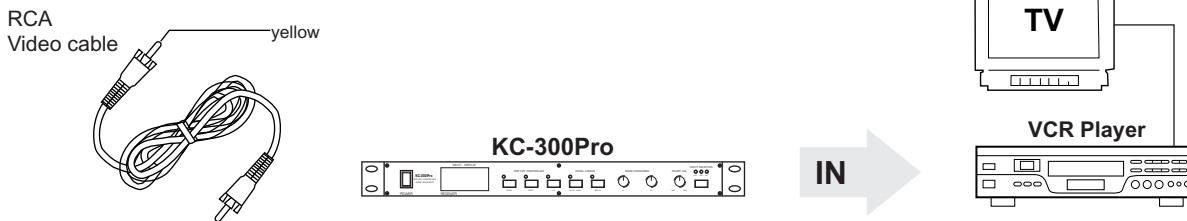

(c) If there is no VCR present, you will need to use an RF Modulator. To obtain an RF Modulator, check with your VocoPro dealer. An RF Modulator can also be purchased from Radio Shack™.

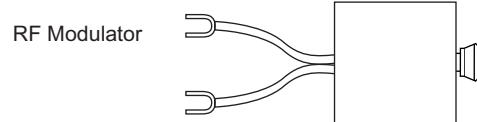

## Powering Up

(a) Plug the power cord of the KC-300Pro to a 120-Volt AC wall outlet. To operate the KC-300Pro from a 220V AC power source, it will be necessary to switch the voltage selector to 220V. This can be done by locating the voltage selector on the rear panel of the KC-300Pro and switching it to the 220V setting.

**Note:** Plugging the KC-300Pro into a 220V power source can severely damage the unit and will void the warranty.

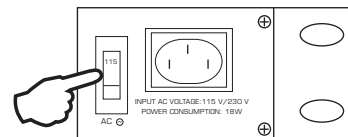

(b) Turn on your input source(s), amplifier/receiver and TV. Do not turn on the KC-300Pro.

(c) Be sure your TV is set to receive video input from the VIDEO INPUT jack. (Some TV's use a VIDEO INPUT, AUX or CHANNEL 0 as a "dedicated" video channel). Check you TV's instruction manual to see how it selects its video channel(s).

(d) Hit the POWER button on the KC-300Pro.

**Your Installation Is Complete!**

# Advanced Operations

## Using the DSP Key Controller

Use the DSP Key Controller to obtain the desired musical key ( $\pm 4$  notes, 17-steps). The DSP Key Controller indicators ( $\pm 8$  and 0 indicators) display the selected pitch. To step DOWN, press the left button marked "b". To step UP, press the right button marked "#". To revert back to the original key, press the RESET button. You can also use the DSP Key Control pad on the Remote Control to obtain DIRECT ACCESS to any of the DSP Key Controller's steps.

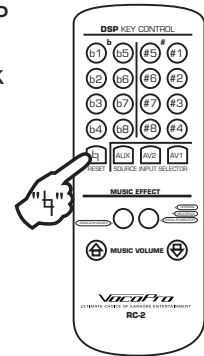
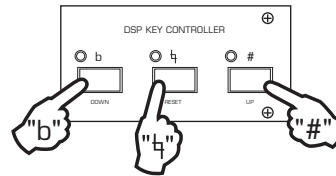

## Removing the Vocal Layer from a Multiplex Disc

When playing a Multiplex disc, you can use the VOCAL CANCEL feature to remove the vocal layer from playback. To select the VOCAL CANCEL audio mode, press the MULTI-AUDIO button on either the front panel or on the remote control one time (look for red LED activity). To remove the VOCAL CANCEL audio mode, hit the MULTI-AUDIO two more times (or till no LED activity is present).

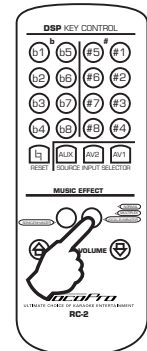
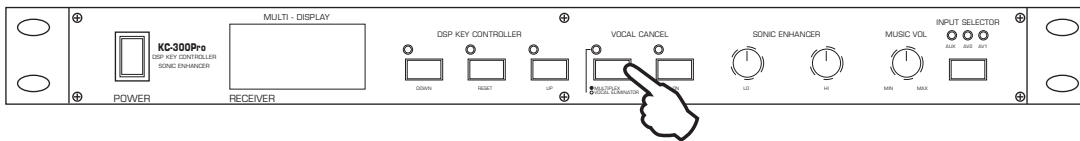

## Removing the Vocal Layer from a Standard (Non-Multiplexed) Disc

When playing a standard CD, you can use the VOCAL ELIMINATOR feature to remove the vocal layer from playback. To select the VOCAL ELIMINATOR feature, press the VOCAL CANCEL button on either the front panel or on the remote control two times (look for an orange LED). To bring vocals back to the mix, Press the VOCAL CANCEL once more (no LED).

**Notes:** This feature is designed to work with any CD, however, results may vary depending on how the disc was recorded originally.

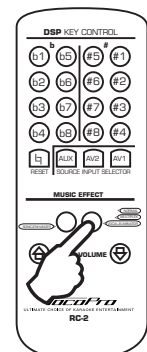
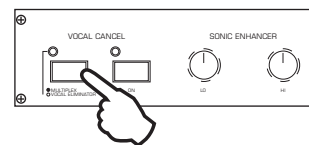

## Using the Sonic Enhancer to Improve Sound Quality

The built-in SONIC ENHANCER has controls to enhance separately the high and low frequencies of an audio signal. First you need to initialize the SONIC ENHANCER. To do this, hit the ON button for the SONIC ENHANCER on either the front panel or on the remote control. To make a LOW FREQUENCY adjustment, adjust the LOW control on the front panel clockwise to increase, or counter-clockwise to decrease. To make a HIGH FREQUENCY adjustment, adjust the HIGH control on the front panel clockwise to increase, or counter-clockwise to decrease. To disable the SONIC ENHANCER, press the ON button on either the front panel or on the remote control a second time.

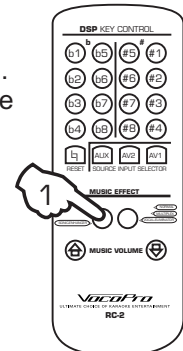
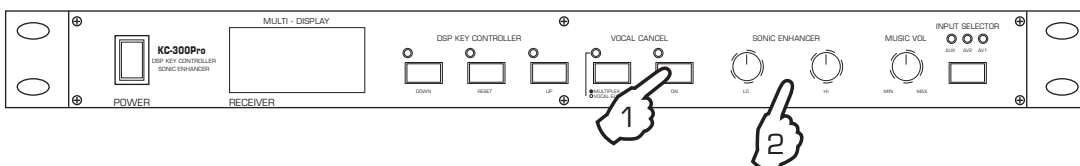

# Troubleshooting

Problem	Cause(s)	Solution(s)
<b>No sound coming from selected music source</b>	Input Selector is set incorrectly	Change Input Selector to the correct current playing source
	Music Master Volume control is set to minimum	Raise Music Master Volume level to an appropriate level
	The Input Level control on the rear panel is set to a minimum position	Turn up the Input Level control on the rear panel
<b>No graphic output from display devices when playing CD+G's</b>	Source player is functioning incorrectly	Replace player and reset the KC-300Pro's power supply
	Video cable(s) are not properly connected	Reconnect cables firmly to correct video jacks
	Disc medium is not a CD+G	Insert a CD+G for playback
	TV or monitor device is not set to the correct video setting	Change TV or monitor settings to accept video
<b>Vocal Eliminator feature is not working properly</b>	Disc is multiplexed	Insert a non-multiplexed disc
<b>Vocal Cancel feature is not working properly</b>	Disc is not multiplexed	Insert a multiplexed disc
<b>No sonic enhancements are being applied to audio</b>	Sonic enhancer is not set to the ON position	Press the ON button on the front panel or remote control
	The LOW and HIGH controls are set at a minimum level	Increase the LOW and HIGH control levels
<b>High pitched squealing occurs when using the microphone</b>	Microphone is pointed to, or too close to speakers	Move microphone away from speakers
	Treble level(s) are too high on microphone channel(s)	Turn down treble level(s) on microphone channel(s)
<b>Remote Control is not functioning</b>	Batteries are out of charge	Replace with new batteries
	There is an obstacle between the Remote Control and Sensor	Clear area between Remote Control and Sensor



# Glossary of Terms

---

**Attenuation** – The decrease in amplitude of a signal.

**Auxiliary channel (AUX)** – A channel reserved for connecting an external audio and/or video device.

**A/V** – A/V is an abbreviation for Audio/Visual.

**Balanced** – A circuit having two sides (conductors) carrying voltages that are symmetrical around a common reference point, typically ground.

**CD+G** – A specially formatted disc with additional sub-code (data) that is capable of displaying lyrics on video screens for Karaoke systems. CD+G stands for Compact Disc + Graphics.

**Clipping** – Refers to a type of distortion that occurs when an amplifier is driven into an overload condition. Usually the "clipped" waveform contains an excess of high-frequency energy. The sound becomes hard and edgy. Hard clipping is the most frequent cause of "burned out" tweeters. Even a low-powered amplifier or receiver driven into clipping can damage tweeters which would otherwise last virtually forever.

**Decibel (dB)** – Named after Alexander Graham Bell. We perceive differences in volume level in a logarithmic manner. Our ears become less sensitive to sound as its intensity increases. Decibels are a logarithmic scale of relative loudness. A difference of about 1 dB is the minimum perceptible change in volume, 3 dB is a moderate change in volume, and about 10 dB is an apparent doubling of volume. 0 dB is the threshold of hearing and 130 dB is the threshold of pain.

**Delay** – Delay is a facet of the echo process. Delay refers to the amount of time that exists between echoes.

**Digital Echo** – Digital echo is a synthetically processed sound effect that mimics natural echo. Echo in general is the "bouncing" of waves back and forth between two surfaces. This effect gives a spacious or ambient feeling that works great with vocals.

**Enhancing** – Electronically adjusting the quality and sharpness of an audio signal.

**Frequency** – The range of human hearing is commonly given as 20-20,000Hz (20Hz-20kHz). One hertz (Hz) represents one cycle per second, 20Hz represents 20 cycles per second and so on. Lower numbers are lower frequencies

**Gain** – To increase in level. The function of a volume control.

**Impedance** – The total of the resistive and reactive opposition, measured in ohms, that a circuit presents to the flow of alternating current at a given frequency.

**Input Selector** – A toggle switcher or auxiliary bus used to select through the available inputs of a given device.

**Line Level** – CD players, VCRs, Laserdisc Players etc., are connected in a system at line level, usually with shielded RCA type interconnects. Line level is before power amplification. In a system with separate pre-amp and power-amp the pre-amp output is line level. Many surround sound decoders and receivers have line level outputs as well.

**Line Voltage** – The voltage level of the main power source to a device.

**Midrange** – A speaker, (driver), used to reproduce the middle range of frequencies. A midrange is combined with a woofer for low frequencies and a tweeter for high frequencies to form a complete, full-range system.

# Glossary of Terms

---

**Multiplex (MPX)** – Multiplex is a type of Karaoke software that has specially formatted left and right channels to make multiplex features available. To be formatted for multiplex use, a disc must have the vocals coded to the right channel and the music to the left channel. When you select a multiplex mode, the unit will remove the right channel (vocals) and split the left channel (music) to both sides.

**Mute** – A mode that turns off the audio output to the monitor speakers. Used when a microphone is in the same room as the monitor.

**NTSC** – National Television Systems Committee. Organization that formulated standards for the NTSC television system. Now describes the American system of color telecasting which is used mainly in North America, Japan, and parts of South America.

**Out of Phase** – When speakers are mounted in reverse polarity, i.e., one speaker is wired +/+ and -/- from the amp and the other is wired +/- and -/+. Bass response will be very thin due to cancellation.

**PAL** – Phase Alternate Line. The name of the color television system in which the EV component of burst is inverted in phase from one line to the next in order to minimize hue errors that may occur in color transmission. PAL is a European color TV system used mainly in Europe, China, Malaysia, Australia, New Zealand, the Middle East, and parts of Africa.

**Pre-Amplifier** – Or Pre-amp is a device that takes a source signal, such as from a turntable, tape deck or CD player, and passes this signal on to a power-amplifier(s). The pre-amp may have a number of controls such as source selector switches, balance, volume and possibly tone controls.

**Rack Mountable** – Rack Mountable refers to the ability to place unit into professional or travel rack cases. Such cases are great for building complete systems and protect them during transportation. The standard rack size for MOST cases is 19”.

**Repeat** – Repeat is facet of the echo process. Repeat refers to the frequency of echoes within a period of time.

**Sub-Code** – Sub-code is specially coded area of data used by CD+G manufacturers to produce lyrics for Karaoke video output.

**Tweeter** – A speaker, (driver), used to reproduce the higher range of frequencies. To form a full-range system, a tweeter needs to be combined with a woofer, (2-way system), or a woofer and midrange, (3-way system).

**VCD** – VCD is a disc formatted in MPEG-1. These discs are good candidates for Karaoke use as they have an audio and a video layer to them. VCD stands for Video Compact Disc.

**Vocal Cancel** – Vocal Cancel is a feature that removes vocals from multiplex CD tracks. To be multiplexed, a disc must have the vocals coded to the right channel and the music coded to the left channel. When you select Vocal Cancel, the unit will remove the right channel (vocals) and split the left channel (music) to both sides.

**Vocal Partner** – Vocal Partner is a feature that removes vocals from multiplex CD tracks much in the same way as Vocal Cancel, but with an added “auto-pilot” function. The main difference is that Vocal Partner will only remove vocals as long as there is activity going through the microphone (singing). When you stop singing, the vocals automatically return.

**Vocal Reducer (Eliminator)** – Vocal Reducer is a feature that removes vocals from standard non-multiplex CD tracks. To do this, the unit compares the audio on the left and right channels, and cancels out any signals that appear on both. Most currently recorded CD’s contain the vocal layer on both sides, however some may not, leading to varying results. This feature is also referred as “Vocal Eliminator”

**Woofer** – A speaker used for low-frequency reproduction, usually larger and heavier than a midrange or tweeter.

**Y-Adapter** – A type of adapter that splits a signal into two parts. An example would be a connector with one male RCA jack on one end, and two female RCA jacks on the other end.

# Recommended VocoPro Gear

---

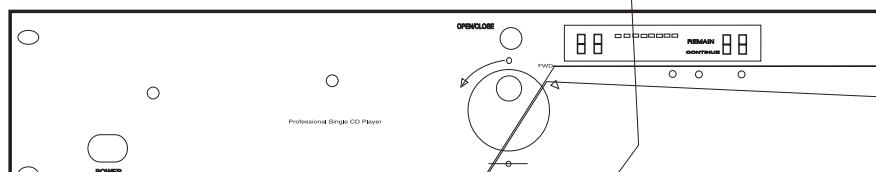

- Switchable 1

# Recommended VocoPro Gear

---

## VP-600X

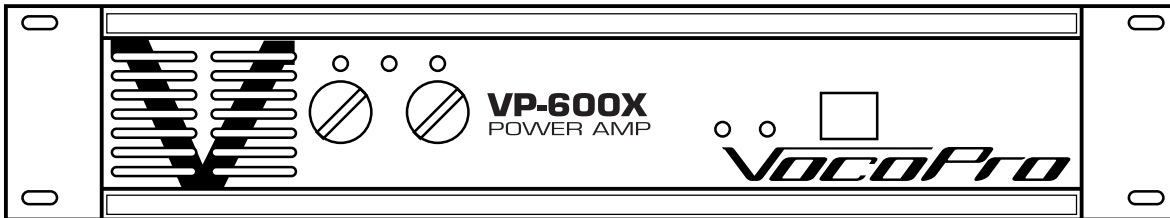

### 2 Space 600W Professional Power Amplifier

- 300W + 300W RMS
- 600W + 600W Max
- THD: 0.05%
- Frequency Response: 20HZ-20KHZ Signal to Noise
  - 1/4" or XLR Inputs
- Input Ratio: Less than 100DB
  - Input Sensitivity: 1.23V
- Dimension: W x D x H (19" x 13" x 1.5")
  - Shipping Weight: 47 Lbs

## Color Monitor

- 15" LCD Color Monitor
- Audio/Video Input
- 2x 5Watts Stereo Speakers
- Phone Output With Volume Control
- Color/Brightness Adjustment
- Multiple Screen Control For Both Table Top Or Auto Roof Mounting
- 12v Dc Adapter Included

## Recommended VocoPro Gear

---

### SV-420

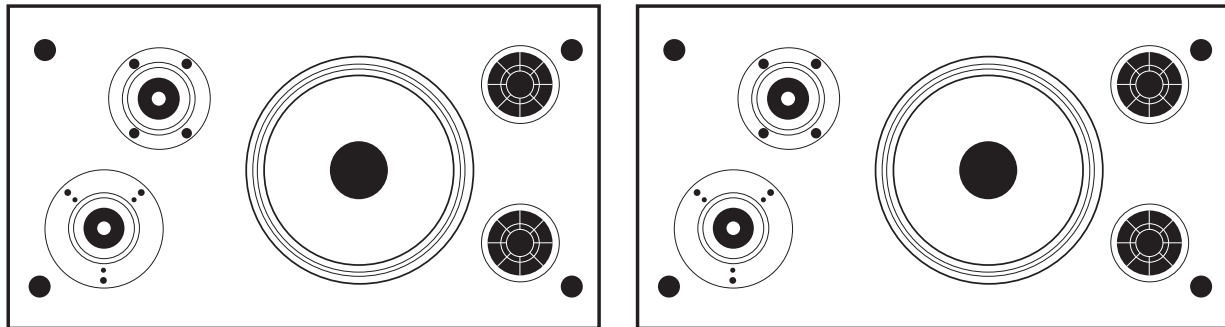

#### Professional 8" 3 Way Vocal Speakers

- 3 Way 8" Karaoke Vocal Speakers (Sold in Pair)
  - Design for Karaoke Studio or Singers Monitor
  - Power Rating: 180 Watts Peak / 90 Watts RMS
    - Metal Grill
    - Impedance: 8 OHM
    - Sensitivity: 92 DB
    - Frequency Response: 20HZ-20KHZ
- Dimensions H x W x D: 19" x 12" x 11.25" (each)
  - Shipping Weight: 50 Lbs. (pair)
- (Dimensional Weight: 60 Lbs. Due to Oversize)

## Free Manuals Download Website

<http://myh66.com>

<http://usermanuals.us>

<http://www.somanuals.com>

<http://www.4manuals.cc>

<http://www.manual-lib.com>

<http://www.404manual.com>

<http://www.luxmanual.com>

<http://aubethermostatmanual.com>

Golf course search by state

<http://golfingnear.com>

Email search by domain

<http://emailbydomain.com>

Auto manuals search

<http://auto.somanuals.com>

TV manuals search

<http://tv.somanuals.com>