

# VocoPro

THE SINGER'S ULTIMATE CHOICE

OWNER'S MANUAL

DA-1055 PRO

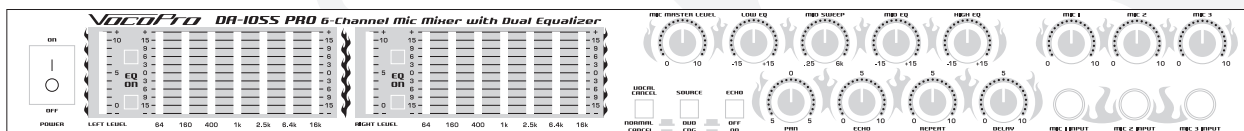

## DA-1055 PRO

Professional Digital Echo Mixer with Dual Equalizers

# Table of Contents

Safety Instructions  
 FCC Information  
 Welcome  
 Listening for a Lifetime

## Specifications and Features

### Getting Connected

Connecting Source Players.....	2
Connecting to a Sound System.....	3-4
Microphone Connections.....	5

### Operations

Basic Operations.....	6
Microphone Operations.....	7-8
7-Band Equalizer Operations.....	8

Descriptions and Functions  
 Troubleshooting

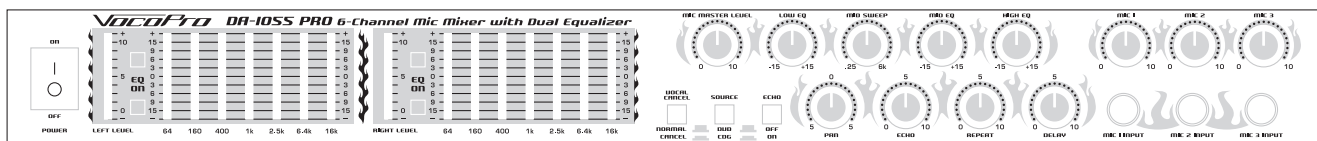

# Safety Instructions



**CAUTION**  
**RISK OF SHOCK**



CAUTION: To reduce the risk of electric shock, do not remove cover (or back). No user-serviceable parts inside. Only refer servicing to qualified service personnel.

## Explanation of Graphical Symbols



The lightning flash & arrowhead symbol, within an equilateral triangle, is intended to alert you to the presence of danger.



The exclamation point within an equilateral triangle is intended to alert you to the presence of important operating and servicing instructions.

## WARNING

To reduce the risk of fire or electric shock, do not expose this unit to rain or moisture.

**1. Read Instructions** - All the safety and operating instructions should be read before the appliance is operated.

**2. Retain Instructions** - The safety and operating instructions should be retained for future reference.

**3. Heed Warnings** - All warnings on the appliance and in the operating instructions should be adhered to.

**4. Follow Instructions** - All operating and use instructions should be followed.

**5. Attachments** - Do not use attachments not recommended by the product manufacturer as they may cause hazards.

**6. Water and Moisture** - Do not use this unit near water. For example, near a bathtub or in a wet basement and the like.

**7. Carts and Stands** - The appliance should be used only with a cart or stand that is recommended by the manufacturer.

**7 A.** An appliance and cart combination should be moved with care. Quick stops, excessive force, and uneven surfaces may cause an overturn.



**8. Ventilation** - The appliance should be situated so its location does not interfere with its proper ventilation. For example, the appliance should not be situated on a bed, sofa, rug, or similar surface that may block the ventilation slots.

**9. Heat** - The appliance should be situated away from heat sources such as radiators, heat registers, stoves, or other appliances (including amplifiers) that produce heat.

**10. Power Sources** - The appliance should be connected to a power supply only of the type described in the operating instructions or as marked on the appliance.

**11. Grounding or Polarization** - Precautions should be taken so that the grounding or polarization means of an appliance is not defeated.

**12. Power-Cord Protection** - Power-supply cords should be routed so that they are not likely to be walked on or pinched by items placed upon or against them, paying particular attention to cords at plugs, convenience receptacles, and the point where they exit from the appliance.

**13. Cleaning** - Unplug this unit from the wall outlet before cleaning. Do not use liquid cleaners or aerosol cleaners. Use a damp cloth for cleaning.

**14. Power lines** - An outdoor antenna should be located away from power lines.

**15. Nonuse Periods** - The power cord of the appliance should be unplugged from the outlet when left unused for a long period of time.

**16. Object and Liquid Entry** - Care should be taken so that objects do not fall and liquids are not spilled into the enclosure through openings.

**17. Damage Requiring Service** - The appliance should be serviced by qualified service personnel when:

- A. The power supply cord or plug has been damaged; or
- B. Objects have fallen into the appliance; or
- C. The appliance has been exposed to rain; or
- D. The appliance does not appear to operate normally or exhibits a marked change in performance; or
- E. The appliance has been dropped, or the enclosure damaged.

**18. Servicing** - The user should not attempt to service the appliance beyond that described in the operating instructions. All other servicing should be referred to qualified service personnel.

### Note:

To CATV system installer's (U.S.A.): This reminder is provided to call the CATV system installer's attention to Article 820-40 of the NEC that provides guidelines for proper grounding and, in particular, specifies that the cable ground shall be connected as close to the point of cable entry as practical.

# FCC INFORMATION (U.S.A.)

## 1. IMPORTANT NOTICE: DO NOT MODIFY THIS

**UNIT!:** This product, when installed as indicated in the instructions contained in this manual, meets FCC requirements. Modifications not expressly approved by Vocopro may void your authority, granted by the FCC, to use this product.

**2. IMPORTANT:** When connecting this product to accessories and/or another product use only high quality shielded cables. Cable(s) supplied with this product **MUST** be used. Follow all installation instructions. Failure to follow instructions could void your FCC authorization to use this product in the U.S.A.

**3. NOTE:** This product has been tested and found to comply with the requirements listed in FCC Regulations, Part 15 for Class "B" digital devices. Compliance with these requirements provides a reasonable level of assurances that your use of this product in a residential environment will not result in harmful interference with other electronic devices. This equipment generates/uses radio frequencies and, if not installed and used according to the instructions found in the owner's manual, may cause interference harmful to the operation of other electronic devices. Compliance with FCC regulations does not guarantee that interference will not occur in all installations. If this product is found to be the source of interference, which can be determined by turning the unit "Off" and "On", please try to eliminate the problem by using one of the following measures:

Relocate either this product or the device that is being affected by the interference.

Use power outlets that are on different branch (circuit breaker or fuse) circuits or install AC line filter(s).

In the case of radio or TV interference, relocate/reorient the antenna. If the antenna lead-in is 300-ohm ribbon lead, change the lead-in to coaxial type cable.

If these corrective measures do not produce satisfactory results, please contact your local retailer authorized to distribute Vocopro products. If you can not locate the appropriate retailer, please contact Vocopro, 1728 Curtiss Court, La Verne, CA 91750.

## CAUTION:

### READ THIS BEFORE OPERATING YOUR UNIT

1. To ensure the finest performance, please read this manual carefully. Keep it in a safe place for future reference.
2. Install your unit in a cool, dry, clean place - away from windows, heat sources, and too much vibration, dust, moisture or cold. Avoid sources of hum (transformers, v motors). To prevent fire or electrical shock, do not expose to rain and water.
3. Do not operate the unit upside-down.
4. Never open the cabinet. If a foreign object drops into the set, contact your dealer.
5. Place the unit in a location with adequate air circulation. Do not interfere with its proper ventilation; this will cause the internal temperature to rise and may result in a failure.
6. Do not use force on switches, knobs or cords. When moving the unit, first turn the unit off. Then gently disconnect the power plug and the cords connecting to other equipment. Never pull the cord itself.
7. Do not attempt to clean the unit with chemical solvents: this might damage the finish. Use a clean, dry cloth.
8. Be sure to read the "Troubleshooting" section on common operating errors before concluding that your unit is faulty.
9. This unit consumes a fair amount of power even when the power switch is turned off. We recommend that you unplug the power cord from the wall outlet if the unit is not going to be used for a long time. This will save electricity and help prevent fire hazards. To disconnect the cord, pull it out by grasping the plug. Never pull the cord itself.
10. To prevent lightning damage, pull out the power cord and remove the antenna cable during an electrical storm.
11. The general digital signals may interfere with other equipment such as tuners or receivers. Move the system farther away from such equipment if interference is observed.

## NOTE:

Please check the copyright laws in your country before recording from records, compact discs, radio, etc. Recording of copyrighted material may infringe copyright laws.

## CAUTION

The apparatus is not disconnected from the AC power source so long as it is connected to the wall outlet, even if the apparatus itself is turned off. To fully insure that the apparatus is indeed fully void of residual power, leave unit disconnected from the AC outlet for at least fifteen seconds.



**Welcome.**

And Thank you for purchasing the **DA-1055 PRO** from VocoPro, your ultimate choice in Karaoke entertainment! With years of experience in the music entertainment business, VocoPro is a leading manufacturer of Karaoke equipment, and has been providing patrons of bars, churches, schools, clubs and individual consumers the opportunity to sound like a star with full-scale club models, in-home systems and mobile units. All our products offer solid performance and sound reliability, and to further strengthen our commitment to customer satisfaction, we have customer service and technical support professionals ready to assist you with your needs. We have provided some contact information for you below.

**VocoPro**  
1728 Curtiss Court  
La Verne, CA 91750  
**Toll Free: 800-678-5348**  
TEL: 909-593-8893  
FAX: 909-593-8890

**VocoPro Company Email Directory**

**Customer Service & General Information**  
info@vocopro.com

**Tech Support**  
techsupport@vocopro.com

**Remember Our Website**

Be sure to visit the VocoPro website [www.vocopro.com](http://www.vocopro.com) for the latest information on new products, packages and promos. And while you're there don't forget to check out our Club VocoPro for Karaoke news and events, chat rooms, club directories and even a Service directory!

We look forward to hearing you sound like a PRO, with VocoPro, your ultimate choice in Karaoke entertainment.

**FOR YOUR RECORDS**

Please record the model number and serial number below, for easy reference, in case of loss or theft. These numbers are located on the rear panel of the unit. Space is also provided for other relevant information

**Model Number** \_\_\_\_\_

**Serial Number** \_\_\_\_\_

**Date of Purchase** \_\_\_\_\_

**Place of Purchase** \_\_\_\_\_

# Listening For A Lifetime

---

Selecting fine audio equipment such as the unit you've just purchased is only the start of your musical enjoyment. Now it's time to consider how you can maximize the fun and excitement your equipment offers. VocoPro and the Electronic Industries Association's Consumer Electronics Group want you to get the most out of your equipment by playing it at a safe level. One that lets the sound come through loud and clear without annoying blaring or distortion and, most importantly, without affecting your sensitive hearing.

Sound can be deceiving. Over time your hearing "comfort level" adapts to a higher volume of sound. So what sounds "normal" can actually be loud and harmful to your hearing. Guard against this by setting your equipment at a safe level **BEFORE** your hearing adapts.

To establish a safe level:

- Start your volume control at a low setting.
- Slowly increase the sound until you can hear it comfortably and clearly, and without distortion.

Once you have established a comfortable sound level:

- Set the dial and leave it there.
- Pay attention to the different levels in various recordings.

Taking a minute to do this now will help to prevent hearing damage or loss in the future. After all, we want you listening for a lifetime.

Used wisely, your new sound equipment will provide a lifetime of fun and enjoyment. Since hearing damage from loud noise is often undetectable until it is too late, this manufacturer and the Electronic Industries Association's Consumer Electronics Group recommend you avoid prolonged exposure to excessive noise. This list of sound levels is included for your protection.

## **Some common decibel ranges:**

Level	Example
<b>30</b>	Quiet library, Soft whispers
<b>40</b>	Living room, Refrigerator, Bedroom away from traffic
<b>50</b>	Light traffic, Normal Conversation
<b>60</b>	Air Conditioner at 20 ft., Sewing machine
<b>70</b>	Vacuum cleaner, Hair dryer, Noisy Restaurant
<b>80</b>	Average city traffic, Garbage disposals, Alarm clock at 2 ft.

## **The following noises can be dangerous under constant exposure:**

Level	Example
<b>90</b>	Subway, Motorcycle, Truck traffic, Lawn Mower
<b>100</b>	Garbage truck, Chainsaw, Pneumatics drill
<b>120</b>	Rock band concert in front of speakers
<b>140</b>	Gunshot blast, Jet plane
<b>180</b>	Rocket launching pad

-Information courtesy of the Deafness Research Foundation

# Specifications and Features

## Graphic Equalizer Section:

Connector .....	RCA/Unbalanced
Input Impedance .....	47k $\Omega$
Bands .....	64Hz, 160Hz, 400Hz, 1KHz, 2.5KHz, 6.3KHz, 16KHz
Range .....	+/-15 dB
T.H.D .....	Less than 0.01%
Frequency Response .....	10Hz ~ 50KHz +/-1 dB
Noise Ratio .....	More than 100 dB

## Microphone Section:

Connector .....	1/4" TRS/Unbalanced
Input Impedance .....	1K $\Omega$
T.H.D .....	Less than 0.1%
Frequency Response .....	20Hz ~ 20KHz +/-3 dB
Noise Ratio .....	More than 85 dB (Echo OFF)
.....	More than 80 dB (Echo ON)

## Tone Control:

High .....	+/-15 dB (10KHz)
Mid .....	+/-15 dB
Mid Sweep .....	250Hz ~ 6KHz
Bass .....	+/-15 dB (80Hz)
Echo Delay Time .....	Max. 300 mS
Dimensions .....	482(W) * 150(D) * 55(H) (mm)

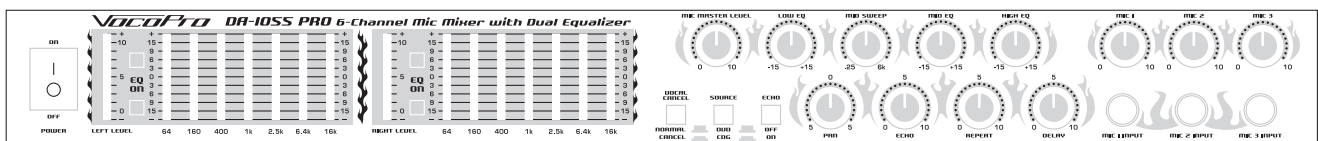

## Getting Connected

### Connecting Source Players to the DA-1055 PRO

You can connect up to two **A/V** source players (CD+G player, DVD player, CD player, Mp3 player, etc.) to the **DA-1055 PRO** simultaneously using **RCA** audio (red & white) and video (yellow) cables.

### Connecting Audio

What you will need:

- Source player with **RCA** audio output jacks
- Pair of **RCA** audio cables. In most cases these are color coded red and white

1. Connect an end of each **RCA** cable to the Left and Right **RCA** audio output jacks on your source player.
2. Connect the other ends of each **RCA** cable to the **AUDIO IN** jacks, labeled **CDG**, on the rear panel of the **DA-1055 PRO**.
3. Repeat steps 1 and 2 when connecting a second source player except this time connect to the **AUDIO IN** jacks labeled **DVD**.

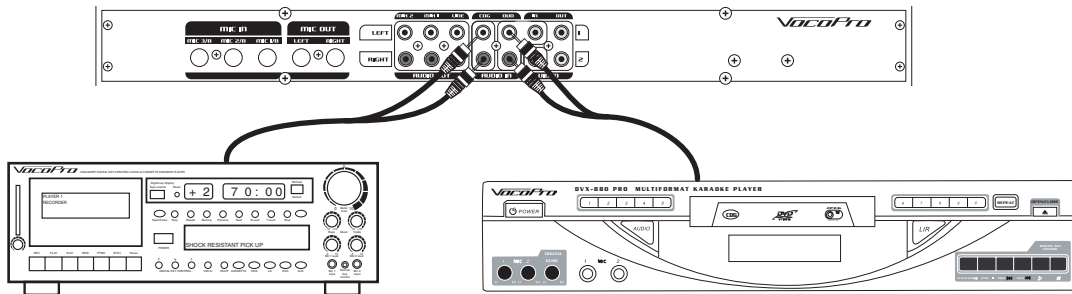

### Connecting Video

What you will need:

- Source player with an **RCA** video output jack
- One **RCA** video cable. In most cases these are color coded yellow.

1. Connect one end of the **RCA** cable to the video output jack on your source player.
2. Connect the other end of the **RCA** cable to the **VIDEO IN** jack.

**NOTE:** For each source player, make sure to connect the video output to the same channel as the audio output.

*i.e.* If you have a **CD+G** player's audio connected to the **CDG AUDIO IN** jacks, make sure you connect that player's video connected to the **CDG VIDEO IN** jack on the **DA-1055 PRO**.

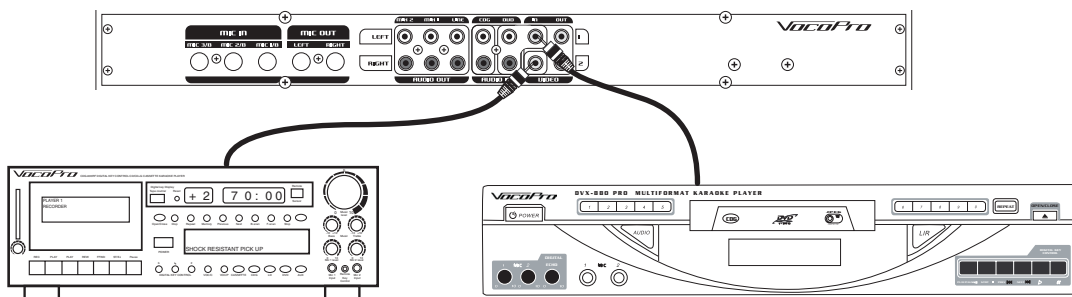



## Getting Connected Cont.

### Connecting to a Sound System (Mixer, amplifier, recording device, etc.)

#### Connecting Audio

The **DA-1055 PRO** has three audio output channels for connecting to mixers, amplifiers, recording devices, etc.

- **MIX 1** and **MIX 2** simultaneously output source player music and microphone vocals.
- **LINE** outputs the **EQ** channels with the source player music only for more convenient mixing of the **EQ** channels.

**NOTE:** Microphone vocals are not present in the **LINE** channel.

What you will need:

- Pair of **RCA** audio cables. In most cases these are color coded red and white
- Mixer, amplifier, recording device, etc.

#### Connecting MIX 1 and MIX 2

Using the **MIX 1** and **2 AUDIO OUT** channels you can connect music and vocals to two different audio devices.

1. Connect an end of each **RCA** cable to the **MIX 1 L/R RCA** output jacks on the rear panel of the **DA-1055 PRO**.
2. Connect the other end of each **RCA** cable to the **L** and **R** **RCA** input jacks on a mixer, amplifier, recording device, etc.
3. To connect to an additional device, follow steps **1** and **2** except now connect to the **MIX 2 L/R RCA** output jacks on the rear panel of the **DA-1055 PRO**.

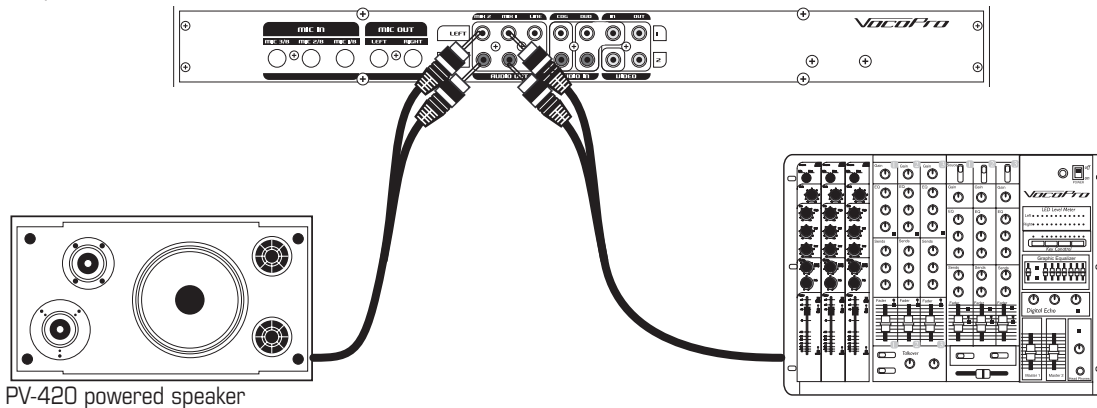

#### Connecting Music-Only Using LINE OUT

1. Connect an end of each **RCA** cable to the **LINE L/R RCA** output jacks on the rear panel of the **DA-1055 PRO**.
2. Connect the other end of each **RCA** cable to the **L** and **R** **RCA** input jacks on a mixer, amplifier, recording device, etc.

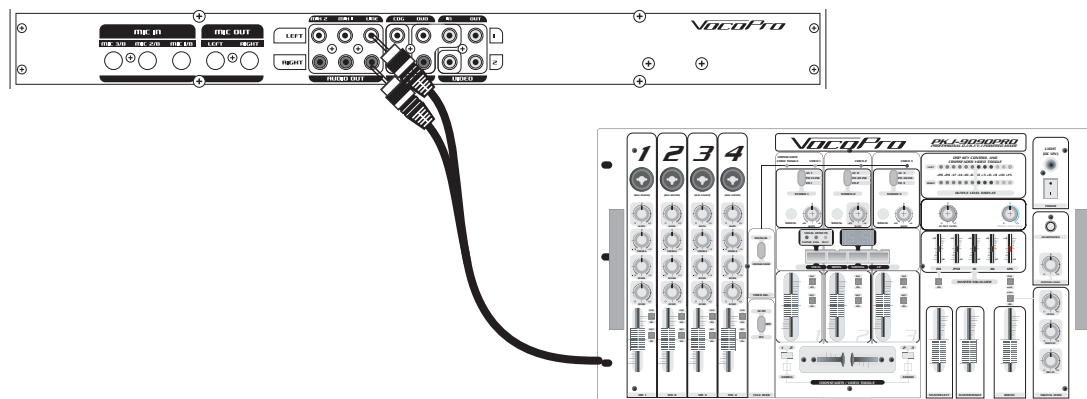

## Getting Connected Cont.

### Connecting to a TV or Monitor

You can connect to up to two TV/video monitors. Use the **SOURCE** button to switch between source player input.

What you will need:

- TV monitor with an RCA VIDEO input.
- **RCA** video cable. In most cases this is color-coded yellow.

NOTE: If your TV does not have an RCA Video input jack, You can connect video using an RF Modulator. (Purchase Separately)

#### To connect video:

1. Connect one end of the **RCA** video cable to the **VIDEO OUT 1** on the rear panel of the **DA-1055 PRO**.
2. Connect the other end to an **RCA** video input on a **TV** or video monitor.
3. To connect to an additional **TV** or video monitor, follow steps the above steps 1 and 2 except now connect a second **RCA** video cable to the **VIDEO OUT 2** on the rear panel of the **DA-1055 PRO**.

NOTE: Both video outputs will output the same video signal.

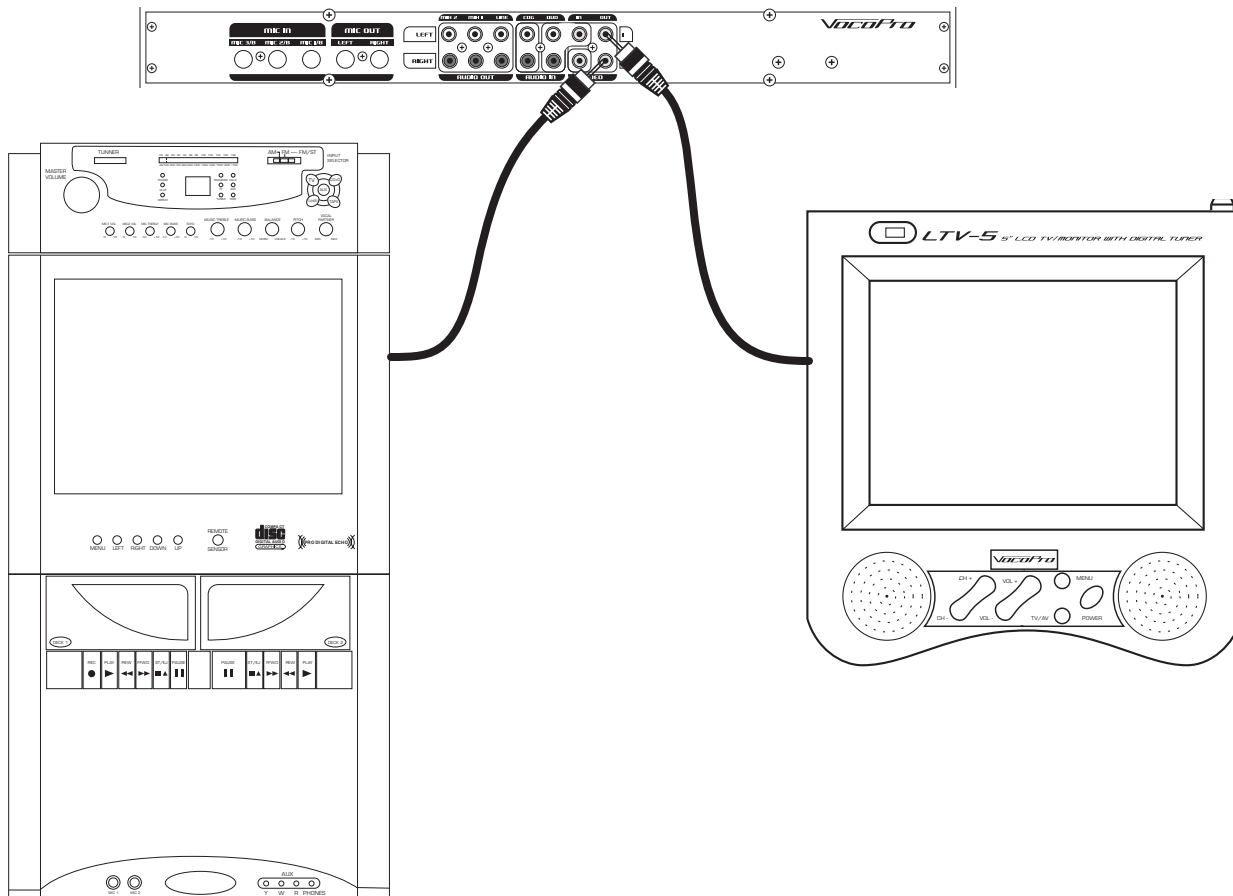

## Getting Connected Cont.

### Microphone Connections

The **DA-1055 PRO** has 6 mic input jacks, allowing you to connect up to 6 microphones using 1/4" microphone cables.

- Mic Volume 1 controls MIC 1 Input (front panel) and MIC 1/B Input (rear panel)
- Mic Volume 2 controls MIC 2 Input (front panel) and MIC 2/B Input (rear panel)
- Mic Volume 3 controls MIC 3 Input (front panel) and MIC 3/B Input (rear panel)

### Microphone Input

You can connect wired microphones as well as wireless microphone systems to the **DA-1055 PRO**. It is preferable to connect wireless microphone systems to the rear mic inputs and wired microphones to the front mic inputs.

See the below diagram for possible microphone connection options:

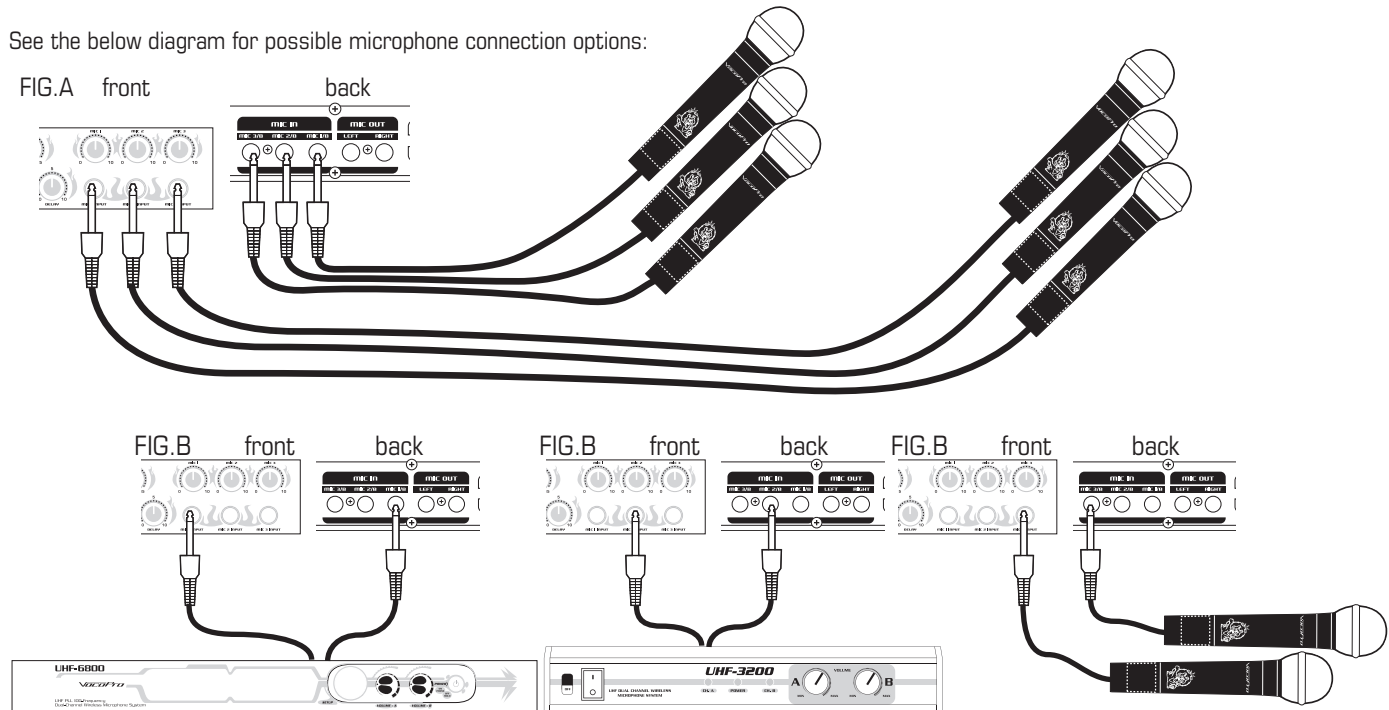

### Microphone Output

Using the **MIC OUT L & R** jacks, you can output the microphone signals exclusively to an external input device such as a mixer or recording device.

What you will need:

- Two 1/4" audio cables
- One external device

1. Connect an end of each 1/4" cable to the **L** and **R** 1/4" outputs on the rear panel of the **DA-1055 PRO**.
2. Connect the other ends of the cables to the appropriate jacks on your external device.

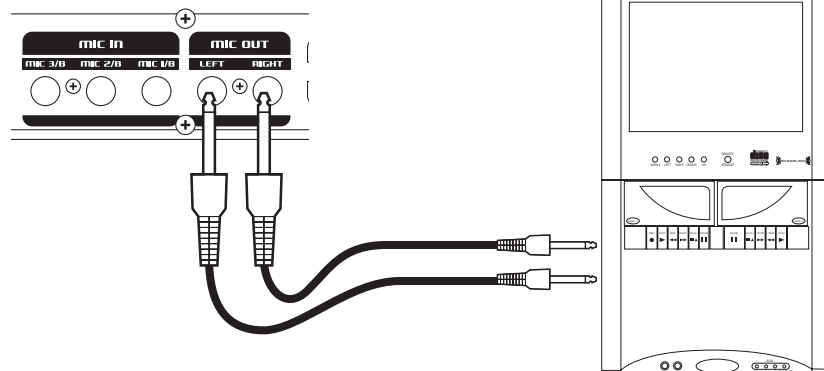

# Operations

## Basic Operations

**ATTENTION:** Before turning on the DA-1055 PRO's power, make sure it is connected to a power outlet, power strip or surge protector. It is recommended that you use a surge protector for increased protection.

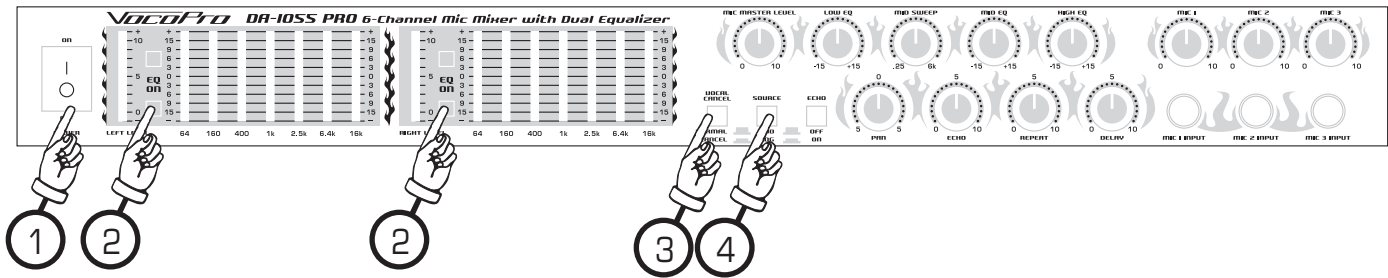

### 1. Turning on the Power

Switch the **POWER** button on the front panel of the **DA-1055 PRO** to the **ON** position to turn it on and switch it to the **OFF** position to turn it off.

### 2. Turning on the EQ channels.

Each **EQ** channel, Left and Right, can be turned on and off individually using the white **EQ ON** buttons.

For each **EQ** Channel:

1. Press the **EQ ON** button in to turn on. The green **LED** indicator will light up when it is on.
2. Press the **EQ ON** button again to turn off. The green **LED** indicator will turn off.

### 3. Using the Vocal Cancel Feature

Vocal Cancel eliminates the vocal track on Multiplex formatted **CD+G** discs allowing the singer to sing along to music only. The **VOCAL CANCEL** button is located on the front panel of the **DA-1055 PRO**.

**NOTE:** Make sure that your **CD+G** disc is Multiplex formatted or else you will not be able to cancel the vocal track.

1. Press the **VOCAL CANCEL** button **IN** to turn on the Vocal Cancel feature.
2. Press the **VOCAL CANCEL** button **OUT** to turn off the Vocal Cancel feature and return to normal mode.

### 4. Switching Between Input Channels

If you have two source players connected, you can only play one at a time. When playing one, you must set the **DA-1055 PRO** to the correct input channel using the **SOURCE** button on the front panel.

1. Press the **SOURCE** button **IN** to turn on the **CDG** channel.
2. Press the **SOURCE** button **OUT** to turn on the **DVD** channel.

## Operations Cont.

### Microphone Operations

#### Adjusting the Independent Volume controls

When there are multiple vocalists present it is common that some will sing louder than others. The volume levels for each pair of mic channels can be adjusted independently to create a balanced vocal mix.

- Mic Volume 1 controls MIC 1 Input (front panel) and MIC 1/B Input (rear panel)
- Mic Volume 2 controls MIC 2 Input (front panel) and MIC 2/B Input (rear panel)
- Mic Volume 3 controls MIC 3 Input (front panel) and MIC 3/B Input (rear panel)

To adjust the independent microphone volumes:

Turn the volume control clockwise to increase the volume and counter-clockwise to decrease the volume.

#### Adjusting the Master Microphone Level

Once you have balanced the individual mic channels you can use the Mic Master Level control to adjust the overall mic level.

To adjust the Master Microphone Level:

Turn the volume control clockwise to increase the volume and counter-clockwise to decrease the volume.

#### Adjusting the Microphone Pan

The Pan control on the front panel allows you to balance the microphone vocal output between the left and right channels. Adjust the pan until you find the best sounding mix for each situation. In most cases it will be sufficient to set the Pan control in the center position.

- Turn the control all the way left to output vocals to the left channel only
- Set the control to the center position to output vocals evenly between both left and right channels
- Turn the control all the way right to output vocals to the right channel only

#### Adjusting the Microphone Tone

The **DA-1055 PRO** allows you to adjust the overall Low, Mid and High **EQ** of the microphone vocals for a more professional and clear vocal tone.

- **LOW EQ:** Use this control to increase or decrease the amount of "low end" or Bass present in the vocals. Too much bass may sound "muddy" or dull. Turn clockwise to increase the low end and counter clockwise to decrease the low end.
- **HIGH EQ:** Use this control to increase or decrease the amount of "high end" or Treble present in the vocals. Too much treble may sound "tinny" and could be the cause of feedback. Turn clockwise to increase the high end and counter clockwise to decrease the high end.
- **MID SWEEP:** Use this control to determine which Mid Frequency will be present in the mix. Since the frequency ranges from the **MID SWEEP** are from 250 Hz to 6K Hz, this is particularly versatile for vocals, and enabling particular characteristics of the singer to be lifted or suppressed.
- **MID EQ:** Use this control to increase or decrease the Mid Frequency that is selected by the **MID SWEEP** control.

## Operations Cont.

### Using the Digital Echo (microphone only)

#### Turning on Echo:

1. Press the **ECHO** button on the front panel IN to turn Echo on.
2. Press the **ECHO** button **OUT** to turn Echo off.

#### Adjusting the Echo settings:

The **DA-1055 PRO** allows you to adjust the Repeat and Delay of the Echo effect.

**Repeat:** The interval time between each repeat. Turning this up (clockwise) increases the time between each repeat and turning this down (counter-clockwise) decreases the time between each repeat.

**Delay:** The length of the overall echo. Turning this up (clockwise) causes the echo to last longer and turning this down (counter-clockwise) shortens the overall time of the echo.

### 7-Band Equalizer Operations

#### Adjusting the 7-Band EQ

The Dual 7-Band Equalizers allow you to adjust the music tone independently for the left and right channels. Every room is different and requires unique **EQ** settings to produce an optimum sound. Adjust the **EQ** until you find the desired tone for the source music.

The following is a general idea of how to use each of the bands however there is no "correct" setting as each performance situation is unique.

**64 Hz** - Fattens up the sub/bass tones or bass "rumble". Generally this is only necessary when using a subwoofer and the low end is more prominent in the mix.

**160 Hz** - Controls the mid-range of the bass/low end.

**400 Hz** - Controls the mid to low frequencies.

**1 K** - Controls the vocal presence, guitars and anything else in the middle frequency range.

**2.5 K** - Controls the more percussive, higher pitched sounds such as snare drums as well as the higher aspects of the vocal signal.

**6.4 K** - Controls the harmonic values of an instrument and is also useful for defining reverb when present.

**16 K** - Controls the highest frequency that is audible to the ears and affects the "shininess" in the mix.

**NOTE:** The 7-Band Equalizers do not affect microphone output.

**NOTE:** Use the **LINE OUT RCA** jacks to output the equalizer channels independently from the microphone channels.

## Descriptions and Functions

### Front Panel

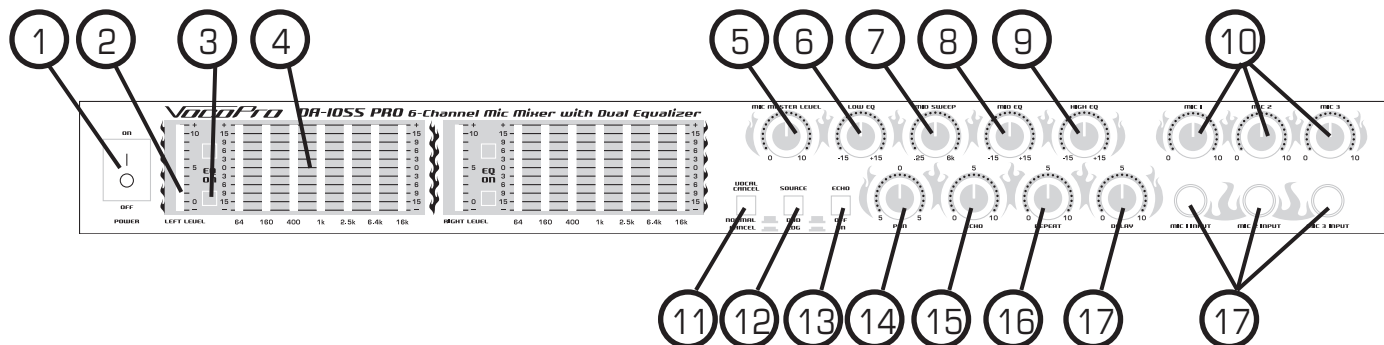

1. **Power switch** - Turns the power **On** and **Off**.
2. **Music Level control** - Adjust the volume of source music. Move sliders up and down to increase or decrease the volume output for that channel.
3. **Graphic EQ On/Off switch** - Turns the 7-Band Graphic Equalizer on and off.
4. **7-Band Graphic Equalizer** - This will increase or cut the 7 different frequencies from **64 Hz** (Lower Frequencies) to **16K Hz** (Higher Frequencies), for precise room tuning of the source music.
5. **Microphone Master Level control** - Use this control to adjust the overall volume of the microphones.
6. **Microphone Low Frequency EQ control** - Use this control to boost or cut the lower frequency (Bass) of the microphones by  $\pm 15$  dB. Turning to the right provides boost, adding warmth to vocals, and turning to the left will reduce the bass.
7. **Mid Sweep control (Microphone)** - Use the Mid-sweep (Frequency) control to determine which frequency to boost or cut. Since the frequency ranges from the Mid-Sweep are from 250 Hz to 6K Hz, this is particularly versatile for vocals, and enabling particular characteristics of the singer to be lifted or suppressed.
8. **Mid Frequency EQ control (Microphone)** - Use the Mid EQ to boost or cut Mid-frequency of the microphone by  $\pm 15$  dB.
9. **High Frequency EQ control (Microphone)** - Use this control to boost or cut the high frequency (Treble) of the microphones by  $\pm 15$  dB. Turning to the right provides boost, adding crispness to vocals, and turning to the left will reduce hiss or distorted consonants and controls the feedback from the microphone.
10. **Mic Input Volume controls** - Use these controls to adjust the microphone input levels for each microphone pair.
  - Mic Volume 1 controls MIC 1 Input (front panel) and MIC 1/B Input (rear panel)
  - Mic Volume 2 controls MIC 2 Input (front panel) and MIC 2/B Input (rear panel)
  - Mic Volume 3 controls MIC 3 Input (front panel) and MIC 3/B Input (rear panel)
11. **Vocal Cancel switch** - Press this to cancel the guide vocal of Multiplex formatted karaoke **CD+G** discs.

**NOTE:** This feature only works with Multiplex formatted discs.

12. **Input Source selector** - Press this to select both audio and video between the two input sources you wish to play. (DVD, CD+G)
13. **Echo On/Off switch** - Press this to turn the microphone Echo on and off.
14. **Pan Control (Microphone)** - Use this control to balance the microphone output between the right and left channels.
15. **Microphone Echo Level control** - Controls the digital echo levels for microphones 1 to 6. Turn to the right to increase the echo effect and turn to the left to decrease the echo effect.
16. **Echo Repeat Level control** - Use this control to adjust the repetition interval of the digital echo effect.
17. **Echo Delay Time control** - Use this control to adjust the timing of the digital echo effect.
18. **Microphone Inputs jacks 1, 2 & 3** - Connects your microphones for vocal input.

**NOTE** - To protect the speakers and the amplifier from microphone feedback, turn down the microphone volume before connecting the microphones.

## Descriptions and Functions Cont.

### Rear Panel

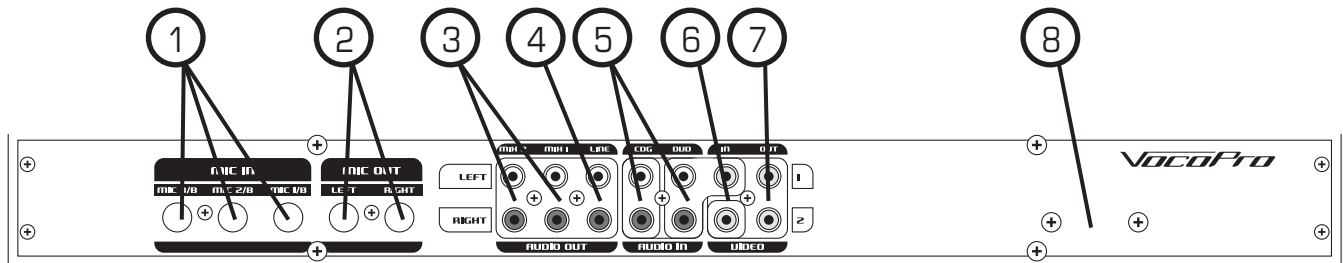

- 1. Mic In jacks 1B, 2B, and 3B** - Connect 3 additional microphones to these jacks using 1/4" mic cables.
- 2. Stereo Mic Output (with Echo)** - Outputs the microphone vocals only along with the Digital Echo effect for independent mixing of vocals.
- 3. Mix 1 & 2 (Mixer Pre-out)** - Outputs (Pre-out) both microphone vocals and source player music.
- 4. Line Out (Music only with EQ)** - Outputs the graphic **EQ** channels (music only) at line level, the volume control and the microphone inputs are both bypassed so the unit can work as an independent graphics equalizer.
- 5. Audio Input jacks** - Connect these jacks to the audio output jacks of up to two source player(s). (DVD player, CD+G player, Cassette player...)
- 6. Video Input jacks** - Connect these jacks to the video output jacks of up to two source player(s). (DVD player, CD+G player...)
- 7. Video Output jacks** - Connect these jacks to the video input jacks of up to two TV monitors.
- 8. Voltage Selector** - Use this selector to select between different input voltages.
  - **115V**- For U.S. Systems
  - **230V**- For European Systems



## Troubleshooting

Problem	Cause	Solution
• <b>There is no sound</b>	• No power	<ul style="list-style-type: none"> <li>• Make sure the power cord is firmly connected and the power is turned on.</li> <li>• If using a surge protector/power strip, make sure it is turned on.</li> </ul>
	• Music or Mic level is too low	<ul style="list-style-type: none"> <li>• Turn up the music level controls on both left and right EQ channels.</li> <li>• Turn up the Individual Mic Volume controls for each mic channel.</li> <li>• Turn up the Mic Master Level control on the front panel.</li> </ul>
	• The wrong input channel is set.	<ul style="list-style-type: none"> <li>• Select the proper input source using the Input Selector on the front panel.</li> </ul>
	• There are improper connection(s) in your setup	<ul style="list-style-type: none"> <li>• Make sure all the components are connected correctly and that there are no defective cables. Refer to the user's manual for each component for correct connection instructions.</li> </ul>
• <b>The vocals are distorted</b>	• The mic volumes are set too high	<ul style="list-style-type: none"> <li>• Try turning down the Mic Master Level and the individual volume controls.</li> </ul>
	• The microphone's tone controls are not properly adjusted.	<ul style="list-style-type: none"> <li>• Set High and Low controls to the center and the Mid control all the way to the right. Then sing into the mic and adjust the Mid-Sweep until the desired frequency of the vocal is found. Then turn down the Mid EQ and adjust the High and Low EQs until the desired vocal sound is found.</li> </ul>
• <b>The music sounds distorted</b>	• The source music volume is too high	<ul style="list-style-type: none"> <li>• Turn down the music level controls on both left and right EQ channels.</li> </ul>
	• The settings on the 7-Band EQ need to be adjusted.	<ul style="list-style-type: none"> <li>• Readjust the EQ sliders to the center and then move each slide up or down to get the desired music tone.</li> </ul>
• <b>Music can only be heard from on side of the speaker</b>	• The music level for one side is not turned on/up.	<ul style="list-style-type: none"> <li>• Turn up the Left and Right music level controls.</li> </ul>
• <b>Vocals can only be heard from on side of the speaker</b>	• The microphone Pan control is set to one side.	<ul style="list-style-type: none"> <li>• Turn the microphone Pan control on the front panel to the center position.</li> </ul>
• <b>There is no Echo</b>	• The Echo On/Off button is switched off or the Echo level control is turned down.	<ul style="list-style-type: none"> <li>• Switch the Echo On/Off button to the ON position and/or turn the Echo level control up.</li> </ul>
• <b>Vocal Cancel is not canceling the vocals</b>	• The CD+G disc you are using is not Multiplex formatted.	<ul style="list-style-type: none"> <li>• Use a CD+G disc that is Multiplex formatted.</li> </ul>

# VocoPro

ULTIMATE CHOICE OF KARAOKE ENTERTAINMENT



© Vocopro 2006

V 1.1

[WWW.VOCOPRO.COM](http://WWW.VOCOPRO.COM)

## Free Manuals Download Website

<http://myh66.com>

<http://usermanuals.us>

<http://www.somanuals.com>

<http://www.4manuals.cc>

<http://www.manual-lib.com>

<http://www.404manual.com>

<http://www.luxmanual.com>

<http://aubethermostatmanual.com>

Golf course search by state

<http://golfingnear.com>

Email search by domain

<http://emailbydomain.com>

Auto manuals search

<http://auto.somanuals.com>

TV manuals search

<http://tv.somanuals.com>