

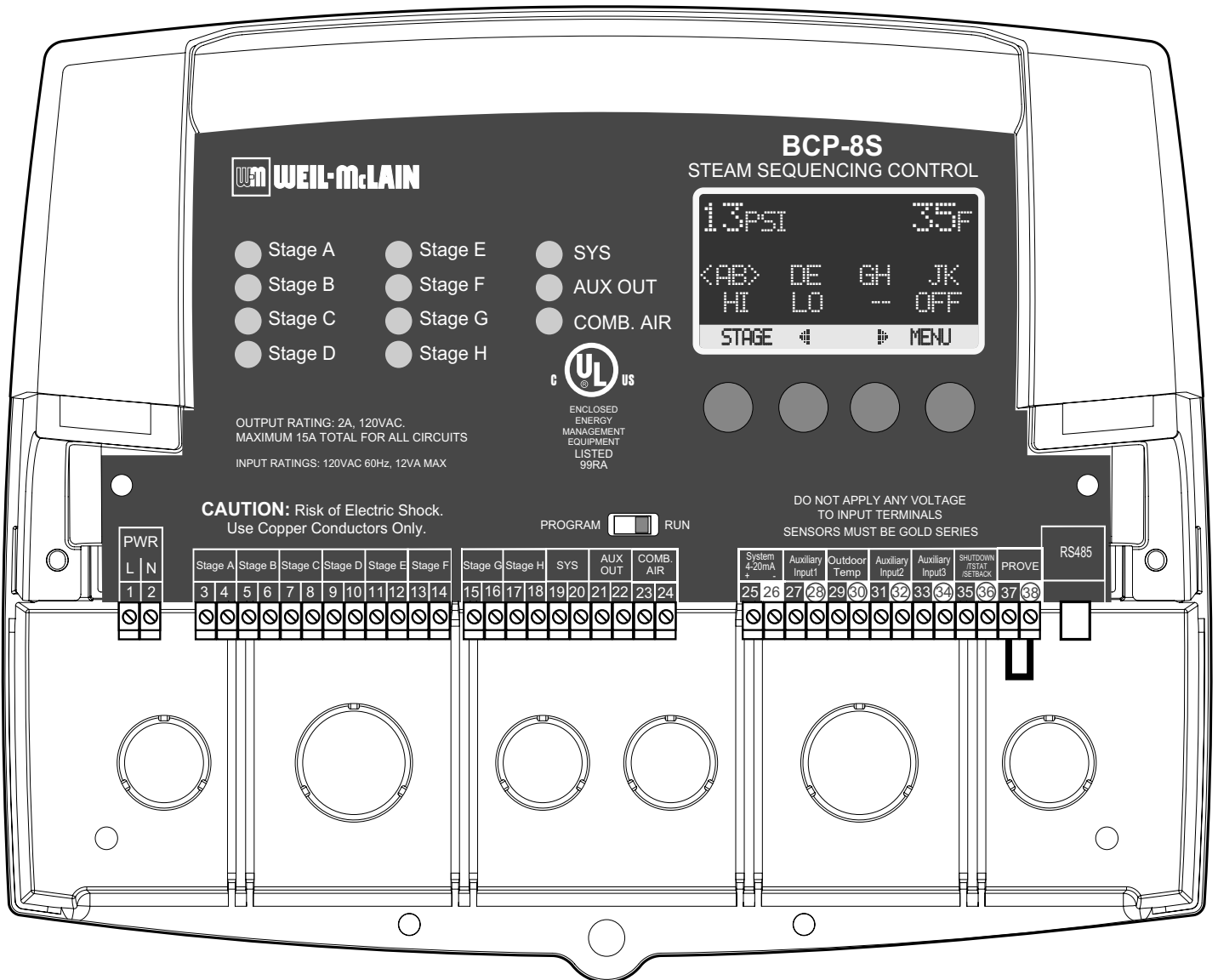

BCP-8S AND BCP-8X

STEAM SEQUENCING BOILER CONTROL AND EXTENSION

- INSTALLATION AND OPERATION INSTRUCTIONS MANUAL
- USER OPERATION INSTRUCTIONS MANUAL



⚠ WARNING

This Weil McLain control is strictly an operating control; it should never be used as a primary limit or safety control. All equipment must have its own certified limit and safety controls required by local codes. The installer must verify proper operation and correct any safety problems prior to the installation of this Weil McLain control.

Contents

BCP-8S LAYOUT	3	Staging	15
BCP-8S OVERVIEW	4	Sequence	16
UNDERSTANDING OPERATION CONCEPT	5	Control Logic	16
PID Operation	5	Sensor Fault	16
OSS Operation	5	Setting the Control to Factory Defaults	16
INITIAL SETUP	6	Operating Settings	17
Selecting the System Features	6	Program Change Settings	17
INSTALLATION	7	Season	17
Mounting the Enclosure	7	Set Point (Not Adjustable in EMS Mode)	17
Install the Sensors	8	Outdoor Cutoff Temperature	17
System Pressure Sensor Installation	8	System Settings	17
Outdoor Sensor Installation	8	Program Change Settings	18
Wiring	9	Stage Settings	18
Wiring the Power (Terminals 1, 2)	9	Reaction Time	18
Wiring the Inputs	9	Purge Delay	18
System Pressure Sensor Wiring (Terminals 25, 26)	9	Minimum Runtime	18
Outdoor Sensor Wiring (Terminals 29, 30)	9	Standby Delay	18
Wiring the Shutdown (Terminals 35, 36)	9	Last Stage Hold	19
Wiring the T-STAT (Terminals 35, 36)	10	Lead Settings	19
Wiring the Setback (Terminals 35, 36)	10	Lead Boiler	20
Wiring the Prove (Terminals 37, 38)	10	Rotate Mode	20
Wiring the Outputs	10	Setback Schedule	20
Wiring the System Output (Terminals 19, 20)	10	Setback	20
Wiring the Comb. Air Damper (Terminals 23, 24)	10	Day/Night Schedules	21
Wiring the Stages (Terminals 3 to 17)	11	Set Present Time	21
Connecting to the BCP-8X Panels and 420MOD		Combustion Air Damper Operation	21
Interface	11	Run-On	21
Selecting the BCP-8X Panel Letter	11	System Exercise	21
INSTALLER MENU SEQUENCE	12	Maintenance	21
STARTUP SETTINGS	14	System & Outdoor Sensor Trim	22
Program Change Settings	14	History	22
Startup Sequence	14	Configuration	22
Control Mode	14	Display	22
Sensor Type	14	Pressure Transducer Default Settings and Ranges24	
Display Standard	14	TROUBLESHOOTING	25
Setting the EMS Set Points (Available in 420MOD only)		USER MENU SEQUENCE	26
14		Program Change Settings	26
Combustion Air Damper Output	15	Season	26
External Input Mode	15	Set Point (Not Adjustable in EMS Mode)	27
Burner Type	15	Outdoor Cutoff Temperature	27
Total Boilers	15	Setback	27
		Day/Night Schedules	27
		SPECIFICATIONS	28

BCP-8S LAYOUT

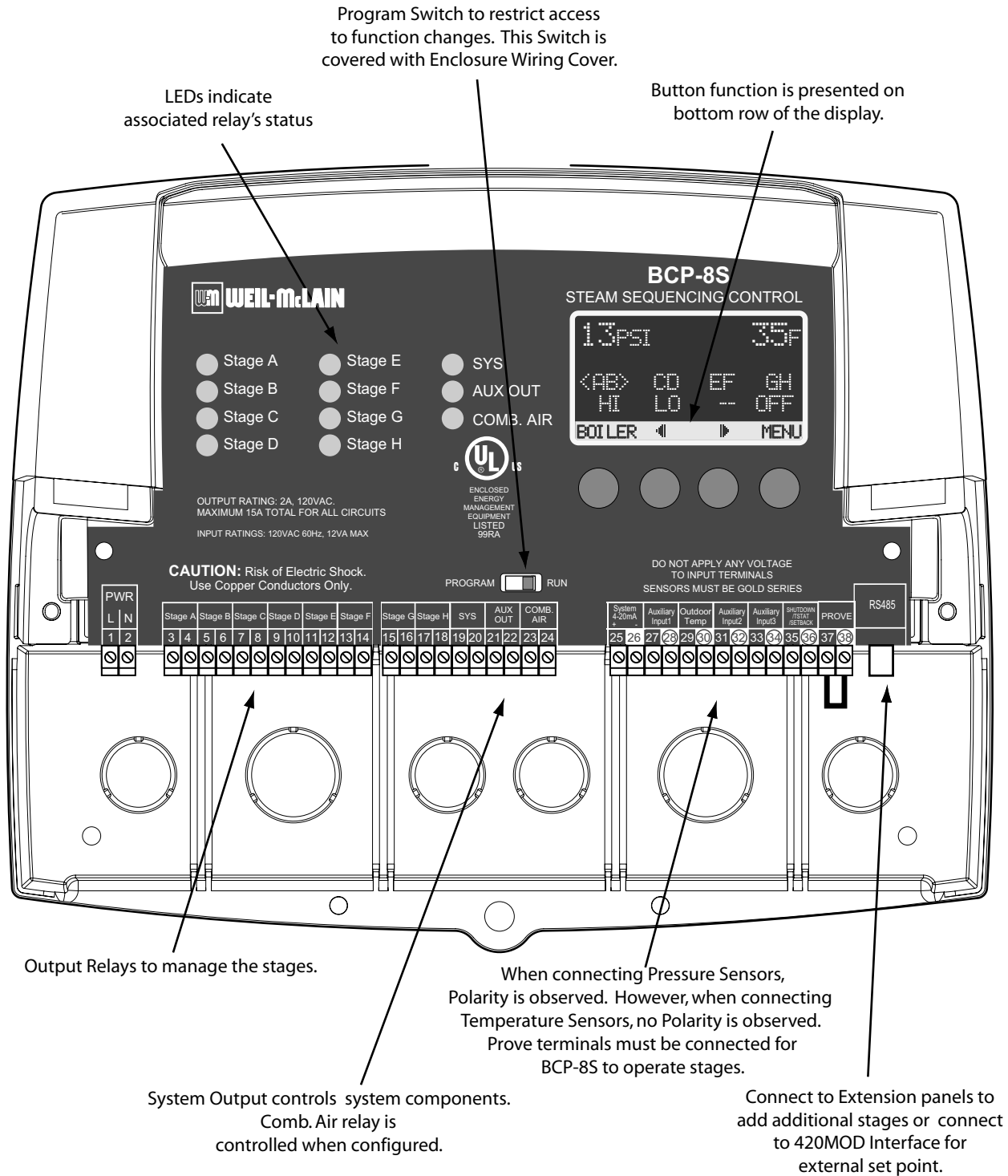

BCP-8S OVERVIEW

SEQUENCES UP TO 8 STAGES

The BCP-8S is the perfect control whenever multiple boilers are required for steam heating applications. The BCP-8S controls the stages to maintain a precise system set point.

PID OR OVER-SIZED-SYSTEM (OSS) LOGIC

The BCP-8S's control PID algorithm allows it to look at the rate of change in the system. If the system oscillation is minimal, the BCP-8S will make slow and gradual output adjustments. If the load is changing quickly, the BCP-8S can be set to OSS sequencing where it will react based on load changes. Therefore, the BCP-8S adapts to specific system requirements and minimizes oscillation around the set point.

DIGITAL DISPLAY OF ALL SYSTEM SETTINGS

The BCP-8S's alphanumeric digital display names each system parameter in simple English and shows its precise value. The easy to follow menu system allows users to quickly make changes to any system setting without having to learn any specialized codes or key commands.

AUTOMATIC ROTATION AMONG STAGES

Rotating the lead stage on a call for output promotes even wear on each boiler. The BCP-8S has three modes of rotation: Manual, FOFO (First-On/First-Off), or Time. The Time option rotates the lead stage every selected period, from every hour to every 41 days.

STANDBY BOILER OPTION

Any of the BCP-8S heating boilers can be set as a Standby boiler with an adjustable Standby delay. Assigning a specific boiler to work in standby mode will remove it from the rotation sequence. In this mode, the boiler will be used as a backup in large demand periods where the primary boilers will not suffice.

SYSTEM AND COMBUSTION AIR DAMPER OUTPUTS WITH PROVE INPUT

These outputs work with the control logic to operate system and a combustion air damper relays. In addition, a System *PROVE* input can be wired in to check the status of either of the components energized by the outputs before the stages can be activated.

NORMAL (LO/HI/LO/HI) OR PARALLEL (LO/LO/HI/HI) SEQUENCING

The BCP-8S can sequence boilers as needed. For boilers where higher efficiency is achieved using lower firing stages, the BCP-8S offers the Parallel Sequencing option. It sequences all the low firing stages of all boilers set to Auto before bringing on the higher firing stages. For other types of heating boilers, using the Normal Sequencing option brings on the lower firing stage followed by the higher one of the same boiler. That will be repeated for each of the lag boilers.

MULTIPLE OR SINGLE STAGING

Unlike many boilers where, to fire a multi-stage boiler both low and high stage relays must be energized, some other equipment require that the operation of the higher stages turn off the lower operating stages. This can be achieved by selecting 'Single' from the Startup Staging menu.

ADD UP TO 16 STAGES

As a stand-alone, the BCP-8S is designed to control eight stages. However, it has the capability of expanding its control to two BCP-8X extension panels each with eight stages. Thus, the BCP-8S can control a total of up to 24 stages.

SETBACK SCHEDULE OR EXTERNAL SIGNAL

Regardless of the type of applications, Setback is an energy saving feature. The BCP-8S offers a built-in day/night schedule for the setback period. On the other hand, if external scheduling is to be used, the Setback can be activated using an external signal by shorting the *SETBACK* input terminals.

UNDERSTANDING OPERATION CONCEPT

The BCP-8S has multiple operating modes that satisfy most steam systems. It can sequence stages to achieve an adjustable Set Point. Moreover, when used with the 420MOD Interface (389-900-226) it can accept a 4-20mA signal as a set point. The 420MOD must be purchased separately. This gives the BCP-8S the capability of being controlled remotely.

PID OPERATION

PID control logic is primarily used for building heating. The logic will utilize two primary settings to add or subtract stages. The Reaction Time is used to turn on/energize stages. On the other hand, the Minimum Runtime is used to turn off/de-energize stages. On a call for heat, by either closing the TSTAT input or opening the SHUTDOWN input, and when the outdoor temperature is below the Outdoor Cutoff, the BCP-8S will turn on/energize the Lead Boiler's lowest firing stage to start the Purge Delay. After the elapse of the purge period, the BCP-8S will start calculating the Reaction Period. If after a full Reaction Time the control logic foresees additional stages are needed, the BCP-8S will energize the following stage. If that stage was another boiler, that boiler has to go through a full Purge Delay before starting to calculate the Reaction Time for that stage. Otherwise, if the next stage was the higher firing stage on the same boiler, the Reaction Time will start from the moment the higher firing stage relay is energized.

When the BCP-8S PID logic foresees that the system will overshoot, regardless of the current system and target values, it will make sure that the last stage turned on/energized elapsed a full Minimum Runtime before it is turned off/de-energized. Except for the lead stage, no additional stages will be turned off/de-energized until another full Minimum Runtime is elapsed. On the other hand, if the last stage is a lead stage, it will remain energized until the system reading exceeds the target set point by the Last Stage Hold value in addition to satisfying the Minimum Runtime condition. That is, if the Set Point was 10 PSI and the Last Stage Hold was set to 2 PSI, the lead stage will remain energized until the system reaches 12 PSI and a full Minimum Runtime elapses. This is useful in protecting the lead stages from short cycling.

OSS OPERATION

OSS is used in fast reacting application as in process applications, where maintaining a set point is critical. The OSS utilizes the Throttle setting, as a mean to calculate the number of stages the BCP-8S shall have on at any point. For every Throttle Range below the set point an additional stage shall be turned on/energized. That is, if the set point was 50 Psi and the Throttle setting was 5 Psi, if the System dropped below 45 Psi (50 Psi - 5 Psi), the lead stage will energize. With further decrease in the system value to 40 Psi (50 Psi - 5 Psi - 5 Psi), the second stage will energize.

As the system pressure rises towards the set point, stages will turn off. Using the previous example, when the system rise to 45 Psi boiler B will de-energize leaving only boiler A on. Boiler A will remain on until the system rises a one full Throttle range above the set point. This will leave the lead boiler A on until the pressure rises to 55 Psi then turn off/de-energize.

Set Point = 50 Psi Throttle = 5 Psi Boilers (A, B, C, D, E, and F) Lead Stage =<A>

System Pressure	Throttle Ranges	Falling Pressure		Rising pressure	
		Stages Turned On	Stages On	Stages Turned Off	Stages On
55 Psi	-1	----	None	A	None
50 Psi	0	----	None	----	A
45 Psi	1	A	A	B	A
41 - 44 Psi	1	----	A	----	A + B
40 Psi	2	B	A + B	C	A + B
35 Psi	3	C	A + B + C	D	A + B + C
30 Psi	4	D	A + B + C + D	E	A + B + C + D
25 Psi	5	E	A + B + C + D + E	F	A + B + C + D + E
20 Psi	6	F	A + B + C + D + E + F	----	A + B + C + D + E + F
15 Psi	7	----	A + B + C + D + E + F	----	A + B + C + D + E + F

MAKE SURE YOU HAVE THE RIGHT CONTROL

If you need the BCP-8S to do additional tasks that either are not listed or do not know how to set them, contact Weil McLain.

INITIAL SETUP

Having an Initial Setup Program will ease the setting of the BCP-8S and will provide the opportunity to utilize many of the energy saving features available in the control and give more comfortable heat when needed.

The program should consist of the following:

- Selecting the features that your system can utilize
- Installation: Install the Control and sensors and its components
- Setting the System Startup
- Setting the System Settings
- Setting the Stages

SELECTING THE SYSTEM FEATURES

The BCP-8S has been designed with Steam heating as the primary purpose. With this in mind, many of the BCP-8S features can be utilized to ease, enhance, and improve your system performance. Some of these features are listed in this section.

SET POINT OR EXTERNAL 4-20MA SET POINT

- The BCP-8S can control the System Pressure either by maintaining an adjustable Set Point or by using an optional 420MOD Interface. (389-900-226). The BCP-8S can receive an external Set Point as a 4 - 20mA signal from an EMS system using the 420MOD Interface.

PID OR OSS CONTROL LOGIC

- The BCP-8S's PID can be used for applications where system reaction is slow and requires a long period to achieve or measure the results. However, OSS can be used for applications where the load changes frequently and the sequencing must match the load and its immediate change.

NUMBER OF STAGES

- The BCP-8S can be configured to control up to eight stages. It can control up to 24 stages by adding a maximum of two BCP-8X Extension Panels, each with eight stages.

CONTROL COMBUSTION AIR DAMPER

- The Combustion Air Damper output can control the equipment while utilizing the *PROVE* input to check the status on the Combustion Air Damper End Switch or any other operating device before any stage is energized.

AUTOMATIC ROTATION AMONG BOILERS

- Rotating the lead boiler to be activated on a call for output promotes even wear on all boilers. The BCP-8S has three modes of rotation: Manual, First-On-First-Off, or Timed Rotation. This option automatically rotates boilers every selected period from one hour to every 41(999 hours) days.

SETBACK OR DAY/NIGHT SCHEDULING

Two Setback modes are available for the BCP-8S:

- The Day/Night Scheduling provides an adjustable time-based schedule for the Setback.
- The Setback mode uses an external signal to switch the operation of the BCP-8S in and out of setback mode.

INSTALLATION

Each of the BCP-8S and BCP-8X consists of three primary enclosure components.

- **The Enclosure Display Module:** contains the display, buttons, LEDs, and electric wiring terminals. It has two screws to hold it to the base. A program configuration switch, used to adjust BCP-8S settings, is placed above the terminals. This switch is enclosed with the Enclosure Wiring Cover for security. The wiring terminals are of the plug-in type to ease installation and removal.
- **The Enclosure Base:** contains the holes to mount and hold the control against the wall or any flat surface. All other enclosure components mount on the base. The bottom section of the Enclosure Base contains the wiring chamber with knockouts on the bottom to ease installation.
- **The Enclosure Wiring Cover:** seals the wires from the external environment. It has two screws to hold it to the base and a hole to secure a lock on the wiring enclosure. A plastic web that separates the wiring chamber into high and low volt sections has been provided.

MOUNTING THE ENCLOSURE

- Select a location near the equipment to be controlled.
- The surface should be flat and sufficiently wide and strong to hold the BCP-8S or the BCP-8X.
- Keep the control away from extreme heat, cold, or humidity. Ambient operating temperature is from 20 to 120°F.
- Remove the Enclosure Wiring Cover from the control enclosure by removing the two bottom screws.
- Remove the Enclosure Display Module by removing the middle screws.
- Screw the Enclosure Base to the surface through the upper and lower mounting holes on the back of the enclosure.
- Replace the Enclosure Display Module and replace the middle screws.
- Do not replace the enclosure wiring cover until all wiring is done.
- When purchasing a padlock for the enclosure, the maximum shank diameter should not exceed 1/4"

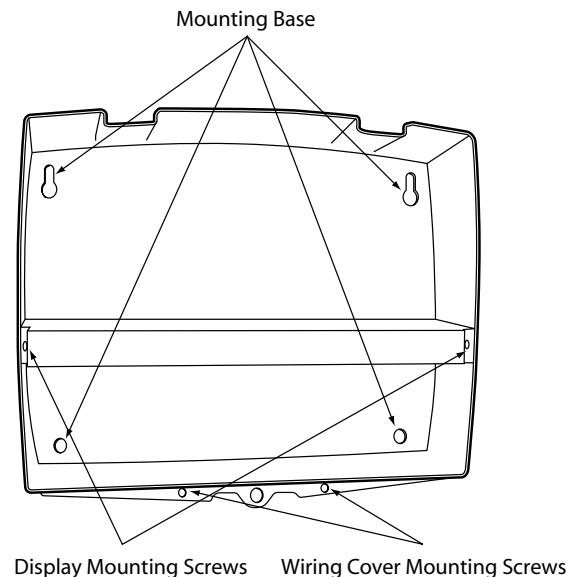
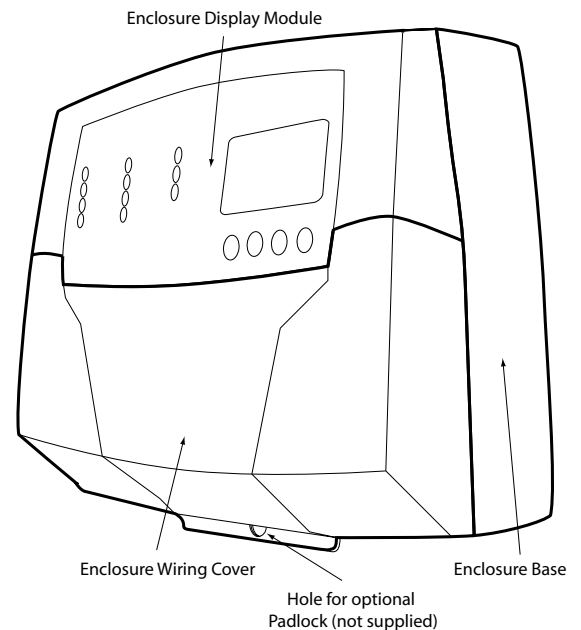

INSTALL THE SENSORS

SYSTEM PRESSURE SENSOR INSTALLATION

LOCATING THE SYSTEM PRESSURE SENSOR

- Install the System Pressure/Vacuum transducer approximately 10' feet past the last boiler on the common supply header but before any takeoffs.
- When installing the pressure transducer, use a threaded Brass Isolation Tube (1/4" Brass Pigtail) to attach to the steam header.
- The Red and Black wires can be extended up to 500' using shielded 2-conductor cable. The ground, shield, and reference tube on the transducer are not used.
- Do not run sensor wires in conduit with line voltage wiring. Class 1 voltage must use a different knockout and conduit from class 2 voltage.

⚠ ALERT

If the System Sensor cannot sense the correct system pressure being supplied to the building, the BCP-8S will not provide comfortable heat levels. Be sure that it is located on the main supply header before any takeoffs.

OUTDOOR SENSOR INSTALLATION

- Only use the Weil McLain sensor (389-900-229 must be purchased separately).
- Locate the sensor in the shade on the north side of the building. The sensor should never be in direct sunlight.
- Be sure the location is away from doors, windows, exhaust fans, vents, or other possible heat sources.
- The sensor should be mounted approximately 10' feet above ground level.
- Adhere the Outdoor Label provided to the back of the sensor base.
- Use the Enclosure Base bottom knockout for the conduit. Use the locknut to hold the conduit and enclosure base together. Screw the cover to the base.
- If screws are used to affix the enclosure to the wall, make sure to seal around the sensor and wall except from the bottom.
- The sensor wires can be extended up to 500' using shielded 2-conductor cable (#18/2). Do not ground the shield at the sensor but at the control using the terminal marked with an "O".
- Do not run sensor wires in conduit with line voltage wiring.

Outdoor Sensor

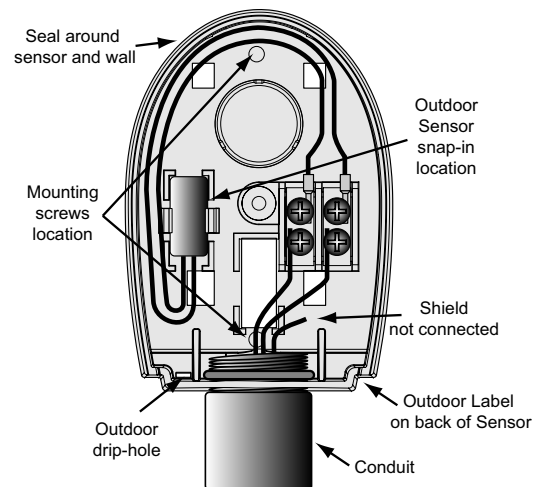

⚠ WARNING

The BCP-8S is an operating control only. All equipment must have all safety and limit controls required by code. It is the responsibility of the installer to verify that all the safety limits are working properly before the BCP-8S is installed.

⚠ ALERT

Determining the proper location for the Outdoor Sensor is very important. The BCP-8S will base its operation on the outdoor temperature information it receives from this location. If the sensor is in the sun, or covered with ice, its reading will be different from the actual Outdoor temperature.

WIRING

WIRING THE POWER (TERMINALS 1, 2)

- Bring the 120VAC 60Hz power wires through the bottom Knockout of the enclosure.
- Class 1 voltage wiring must use a different knockout and conduit from any Class 2 voltage wiring.
- Connect the hot line to terminal marked *L*.
- Connect the neutral line to the terminal marked *N*.

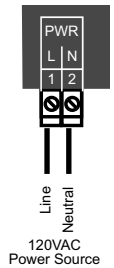

⚠ WARNING

Class 1 voltage wiring must use a different knockout and conduit from any Class 2 voltage wiring. Weil McLain recommends installing a surge suppressor on the power source to the BCP-8S.

WIRING THE INPUTS

SYSTEM PRESSURE SENSOR WIRING (TERMINALS 25, 26)

- The BCP-8S is designed to be connected to a Weil McLain Pressure or Vacuum sensor located on the common header. Contact the factory for pressure sensor options.
- Pressure sensor wires can be extended up to 500' by splicing shielded 2-conductor cable (Belden #8760 or equivalent).
- Connect the Red wire to terminal 25 (+) and connect the Black wire to terminal 26 (-).

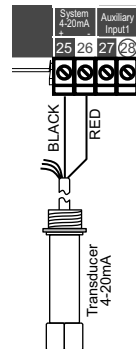

⚠ WARNING

Connect the Temperature sensor shield at the control to terminal 30 marked with "O". Do not connect the Shield at the sensor end.

OUTDOOR SENSOR WIRING (TERMINALS 29, 30)

- Whether in Set Point or EMS 4-20mA modes, the outdoor sensor can be used as an Outdoor Cutoff. The BCP-8S will disable all boilers when the outdoor temperature is above the adjustable Outdoor Cutoff temperature. This feature will automatically be activated when an outdoor sensor is connected.
- For an outdoor sensor use a Weil McLain outdoor sensor provided.
- The sensor wires can be extended up to 500' using shielded 2-conductor cable (Belden #8760 or equivalent).
- Temperature sensors have no polarity. Connect the wires from the outdoor sensor to the BCP-8S terminals marked *OUTDOOR TEMP* - 29, 30.
- Connect the shield to the circled terminal 30 with one of the sensor wires.

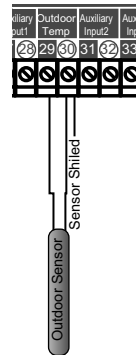

WIRING THE SHUTDOWN (TERMINALS 35, 36)

- This feature will only be available when Shutdown is selected as the External Input Mode option from the Startup menu on page 15.
- This feature can be used whenever it is desirable to turn off the BCP-8S stage outputs from a remote location, another controller (i.e. EMS input), or a switch.
- When the Shutdown feature is enabled by closing a dry contact, all active stages will immediately turn off. The System and Comb. Air relays will remain energized for the Run-On delay period and then turn off.
- The Shutdown signal must be a dry contact only. No voltage can be placed across the *SHUTDOWN* terminals.
- Bring the two wires from the dry contact to the terminals marked *SHUTDOWN*- 35,36.
- When Shutdown is selected, Setback will be available using the programmed Day/Night schedule.

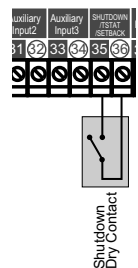

BCP-8S Installation and Operation Manual

WIRING THE T-STAT (TERMINALS 35, 36)

- This feature can be used whenever it is desirable to switch the BCP-8S to operate from a remote location (i.e. EMS input or thermostat). It will only be available when Tstat is selected as the External Input Mode option from the Startup menu on page 15.
- When the Tstat is enabled by closing a dry contact, the BCP-8S will activate the heating logic.
- The Tstat signal must be a dry contact only. No voltage can be placed across the *TSTAT* terminals.
- Bring the two wires from the dry contact to the terminals marked *TSTAT*- 35,36.
- When Tstat is selected, Setback will be available using the programmed Day/Night schedule.

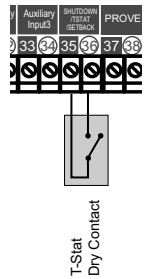

WIRING THE SETBACK (TERMINALS 35, 36)

- This feature will only be available when Setback is selected as the External Input Mode option from the Startup menu on page 15.
- It can be used when it is desirable to switch the BCP-8S to operate in Setback from a remote location (i.e. EMS input or external time clock). No Day/Night scheduling options will be available with this feature.
- When the Setback is enabled by closing a dry contact, the Target will be reduced by the Setback value.
- The Setback signal must be a dry contact only. No voltage can be placed across the *SETBACK* terminals.
- Bring the two wires from the dry contact to the terminals marked *SETBACK*- 35,36.

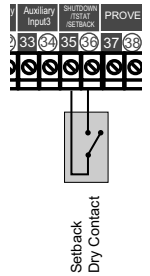

WIRING THE PROVE (TERMINALS 37, 38)

- The Prove feature is provided to check system component operation before energizing the stages. It can be used to check on the Combustion Air Damper by connecting it to the end switch of the damper. In this case, the Comb. Air Output option must be activated from the Startup Menu on page 15.
- If the Comb. Air Damper Output option was not activated, the PROVE input can be used to check on the System Output. A typical use of this feature is to check for system components before energizing any stage.
- If the PROVE input is open on a call, the BCP-8S will enable only the System and Comb. Air Output relays. All stage outputs will be off.
- A factory-installed jumper provides the System Prove signal. Do not remove the jumper unless it will be replaced by a Prove signal.
- Bring the two wires from the prove dry contact source to the terminals marked *PROVE* - 37, 38. No voltage can be placed across the *PROVE* terminals

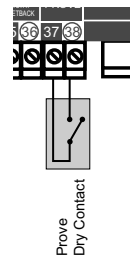

⚠ WARNING

The PROVE input cannot be used as a safety limit. All equipment must have its own certified limit and safety controls as required by local codes. No boiler stage will start unless Prove terminals are shorted. DO NOT remove the PROVE jumper supplied unless replacing it with a Prove signal.

WIRING THE OUTPUTS

WIRING THE SYSTEM OUTPUT (TERMINALS 19, 20)

- The System output relay will energize whenever the outdoor temperature drops below the Outdoor Cutoff or whenever a stage output is active. If no outdoor sensor is connected and the last boiler relay has de-energized, the System relay will remain energized for a period set by the Run-On then de-energize.
- No stage outputs will be activated until the *PROVE* input is shorted.
- The System output relay is a Normally Open (N.O.) dry contact. It does not source any power.
- Class 1 voltages must enter the enclosure through a different opening from any Class 2 voltage wiring

WIRING THE COMB. AIR DAMPER (TERMINALS 23, 24)

- The BCP-8S can control the Combustion Air Damper when the Comb. Air Output option is activated in the Startup Menu (See page 15). In this scenario, the *PROVE* input will be used to check on the Combustion Air Damper status.
- The BCP-8S will energize the Combustion Air Damper relay whenever there is a call to energize any of the boiler stages.
- The Comb. Air output relay is a Normally Open (N.O.) dry contact. It does not source any power.
- Class 1 voltages must enter the enclosure through a different opening from any Class 2 voltage wiring.

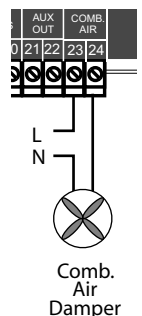

WIRING THE STAGES (TERMINALS 3 TO 17)

- The BCP-8S can be configured to operate the stages of On/Off or multi-stage boilers.
- The relays are N.O. dry contacts only. They do not source any voltage.
- Wire the N.O. relay contacts in series with the boiler's limit circuit.
- When wiring several multi-stage boilers, start with the lower stage of the first boiler and wire it to Output A followed by the higher stage of the same boiler and wire it to Stage B.

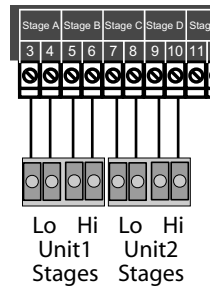

CONNECTING TO THE BCP-8X PANELS AND 420MOD INTERFACE

- The BCP-8S is equipped with a phone socket (RS485) to connect to the BCP-8X Extension panels or the 420MOD Interface (389-900-226) using the provided 6-pin phone cable.
- Each BCP-8X Extension has two RS485 communication ports. Use one to connect to the BCP-8S. Use the other port to connect to the second extension or the 420MOD Interface (389-900-226).
- Additional compatible devices can utilize the second RS485 connection on the second BCP-8X Extension. An example would be to use the 420MOD Interface (389-900-226) to provide a 4-20mA set point signal to the BCP-8S.

SELECTING THE BCP-8X PANEL LETTER

- The BCP-8S is capable of communicating to two BCP-8X Extensions. However, each extension must be identified as either A or B using the switch on each extension to avoid having communication problem.
- Extension A requires the Switch to be set to "A" and will operate stages "I" through "P". While Extension B requires the Switch to be set to "B" will operate stages "Q" through "X".



Connecting BCP-8 to Two Extension Panels and 420MOD Interface using RS485

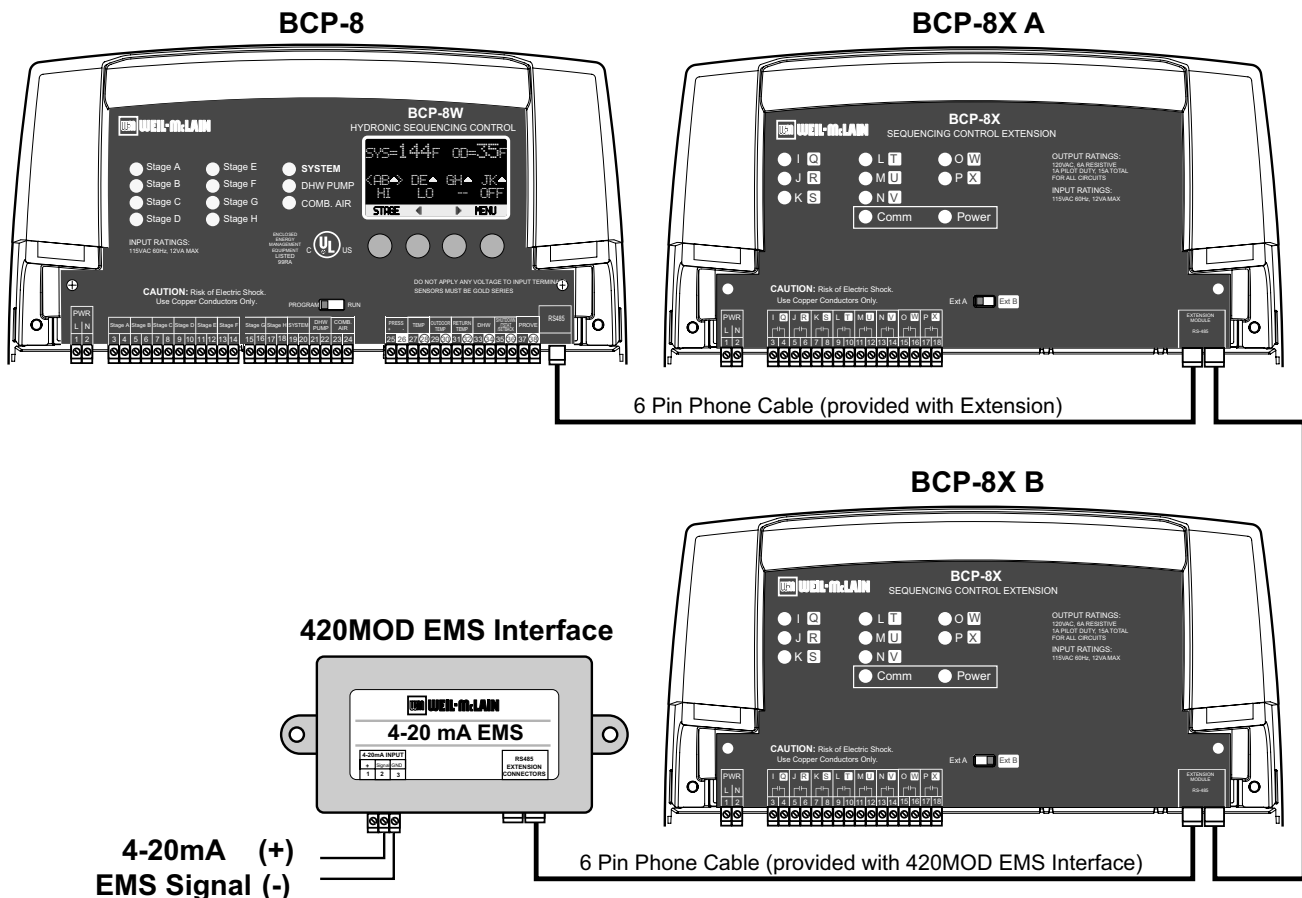

INSTALLER MENU SEQUENCE

STARTUP

```

8.5 Psi    45°F
TGT=9.0 Psi
ABC    <DEF>
-----
LO
Boiler 4  Menu
    
```

```

ARE YOU SURE?
No
Yes
BACK  SAVE
    
```

```

-- CONTROL MODE --
Set Point
EMS 4-20mA
BACK  SAVE
    
```

⚠ ALERT

- To access Installer Menu, hold down the Menu button for over three seconds.
- To be able to change the BCP-8S settings the Program/Run Switch must be set to Program.

```

--- SENSOR TYPE ---
Pressure 15psi
Pressure 30psi
Pressure 100psi
Pressure 200psi
Pressure 300psi
Pressure 0.250MPa
Pressure 0.600MPa
Pressure 1.000MPa
Pressure 1.600MPa
Vacuum 3in/762mm
BACK  SAVE
    
```

```

----- SETTINGS -----
Season      Winter
Set Point   9 psi
EMS SetPoint 9 psi
<System Settings>
<Maintenance>
<System Startup>
BACK  SELECT
    
```

```

--- SENSOR FAULT ---
Stages On
Stages Off
BACK  SAVE
    
```

```

-DISPLAY STANDARD -
English
Metric
BACK  SAVE
    
```

MAINTENANCE

```

----- MAINTENANCE -----
Unit      °F
Present Time 12:30P
<Sensor Trim>
<Histories>
<Configuration>
BACK  SELECT
    
```

```

--- CONTROL LOGIC ---
PID
OSS
BACK  SAVE
    
```

```

EMTS SET POINT
EMS 4mA SET POINT
0 Psi
[ ]
BACK  SAVE
    
```

```

BCP-8S V1.00
Pressure 30psi
EMS 4-20mA, Shtdown
0psi - 30psi
BACK  NEXT
    
```

```

----- SEQUENCE -----
Lo/Hi/Lo/Hi
Lo/Lo/Hi/Hi
BACK  SAVE
    
```

```

EMTS SET POINT
EMS 20mA SET POINT
30 Psi
[ ]
BACK  SAVE
    
```

```

Sys=10 Psi  10:00AM
[Graph]
BACK  NEXT
    
```

```

----- STAGING -----
Multiple Outputs
Single Output
BACK  SAVE
    
```

```

-COMB. AIR OUTPUT-
No
Yes
BACK  SAVE
    
```

```

--- SENSOR TRIM ---
Sys Trim +0.0 Psi
Outdoor Trim +0°F
BACK  SELECT
    
```

```

-- TOTAL BOILERS --
8
[ ]
BACK  SAVE
    
```

```

-- EXTERNAL INPUT -
Shutdown
Tstat
Setback
BACK  SAVE
    
```

```

--- BURNER TYPE ---
On/Off
2-Stage
3-Stage
4-Stage
BACK  SAVE
    
```

BOILER MENU

```

- BOILER AB MODE -
Auto
Standby
Off
On
BACK  SAVE
    
```

```

----- BOILER AB -----
Mode      Auto
Runtime   58hrs
<Prev Boiler>
<Next Boiler>
BACK  SAVE
    
```

```

BOILER AB Runtime
58hrs
BACK  CLEAR  OK
    
```

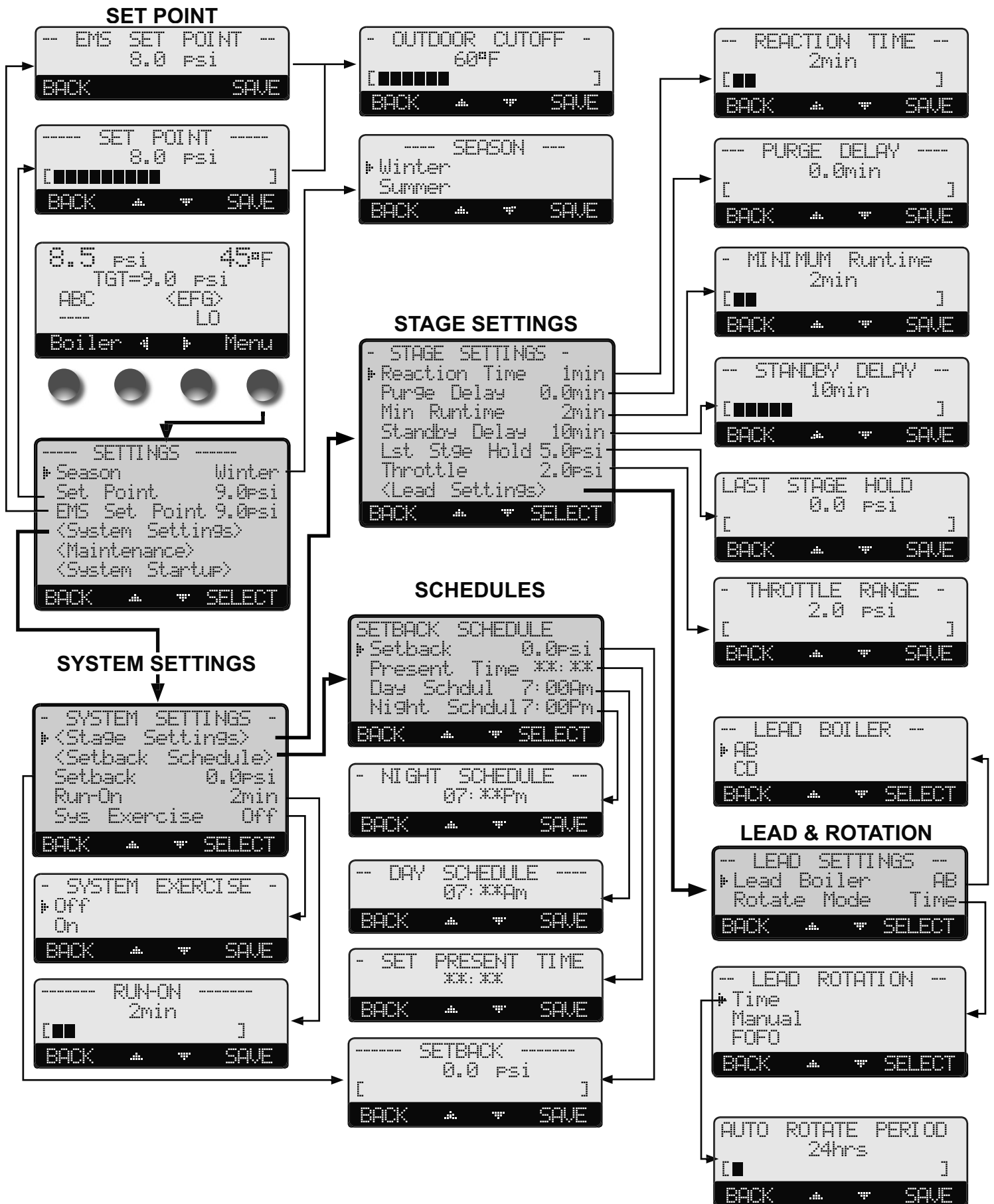

STARTUP SETTINGS

Can be accessed by holding down the Menu button for over three seconds.

⚠ ALERT

A good practice after performing any Startup menu modifications is to check all operating settings and adjustments to match the new settings.

PROGRAM CHANGE SETTINGS

To be able to change the BCP-8S settings the Program/Run Switch must be set to Program. The switch is located under the Enclosure Wiring Cover for security. The Enclosure Wiring Cover can be securely closed using a padlock.



STARTUP SEQUENCE

Hold Button: MENU/<System Startup>

- When powered, the BCP-8S performs a self-test on its components. After the self-test diagnostics have been successfully completed, the BCP-8S will initialize the panel.
- On the first power up, the System Startup screen will appear after the initialization is complete. If it does not, the BCP-8S has already been configured.
- The System Startup menu sets the main parameters as the type of sensor, the sequencing mode, and many other parameters described in this section.
- Before entering the Startup menu, several warnings will alert you to the consequences of making Startup changes.



CONTROL MODE

Set Point, EMS 4-20mA

Default: Set Point

Hold Button: MENU/<System Startup>/.../Control Mode

- Set Point mode does not require an outdoor sensor. If an outdoor sensor is connected in Set Point mode it will be used only as an Outdoor Cutoff point. That is, to turn the stages, system, and Comb. Air relays off.
- The EMS 4-20mA option allows the BCP-8S to receive an external set point from an EMS/BMS system. This requires the use of the 420MOD Interface (389-900-226).
- You must select the 4mA (min) and 20 mA (max) Set Points in the following screens.



SENSOR TYPE

Pressure 15Psi, 30Psi, 100Psi, 200Psi, 300Psi, 0.25MPa, 0.6Mpa, 1MPa, 1.6MPa, Vacuum 3in, 762mm

Default: 30 psi

Hold Button: MENU/<System Startup>/.../Sensor Type

- The BCP-8S can accept a variety of pressure or vacuum transducers. This option will allow the BCP-8S to utilize the proper sensor data based on the Sensor Type selected.

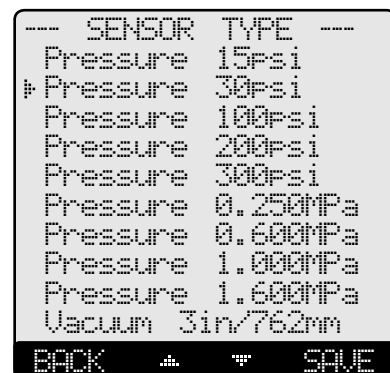

DISPLAY STANDARD

English, metric

Default: English

Hold Button: MENU/<System Startup>/.../Display Standard

- The BCP-8S can control boilers in steam heating environment. It gives the user the capability of displaying pressure and temperature information in either of the standards.



SETTING THE EMS SET POINTS (AVAILABLE IN 420MOD ONLY)

Hold Button: MENU/<System Startup>/.../EMS 4mA Set Point/EMS 20mA Set Point

- If EMS 4-20mA is selected from the Control Mode Menu as the pressure set point source, the user must purchase a Weil McLain 420MOD Interface (389-900-226) to accept the 4-20mA signal and transmit it to the BCP-8S.
- In addition, the user will need to set the pressure range parameters in the Startup Menu. First, set the pressure reading at 4mA, then the set it at 20mA.
- The BCP-8S will only read the pressure range between 2.4mA and 21.6mA based on the 4mA and 20mA settings entered.
- To shutdown the control using the EMS signal, send a signal that is above or below the 2-22mA range. The display will show the message "Shutdown by EMS" and all stages will de-energize. However, the System and Comb. Air relays will continue for the Run-On delay period then de-energize.



COMBUSTION AIR DAMPER OUTPUT

No, Yes

Default: Yes

Hold Button: MENU/<System Startup>/.../Comb. Air Output

- This option allows the user to select if the BCP-8S should be controlling the Combustion Air Damper or not.
- If Yes is selected, the BCP-8S will energize the Comb. Air relay whenever there is a call for a boiler and will use the *PROVE* input to check on the status of the Combustion Air Damper. When the last stage is de-energized, the Comb. Air relay will remain energized for the Run-On period then de-energize.
- In a failure situation, the message "Wait for Comb. Prove" will display when there is a call for a boiler until Prove is shorted.
- If Prove fails after boiler stages where energized, the stages will de-energize and the message "Comb. Prove Failure" will display until the situation is rectified.
- If No is selected, the *PROVE* input will be used to check System status instead of the Combustion Air Damper.
- When not using the *PROVE* input, leave the supplied jumper in place on terminals 37 and 38.



EXTERNAL INPUT MODE

Shutdown, Tstat, Setback

Default: Shutdown

Hold Button: MENU/<System Startup>/.../External Input

- The Shutdown function allows the BCP-8S to receive a remote shorting/closing signal to terminals 35 and 36 to turn off all the relays including all boiler stages.
- The Tstat option gives terminals 35 and 36 the capability of functioning as a heat-call. That is, when the terminals are shorted, the BCP-8S will sequence the stages to maintain the set point. However, when terminals are opened, all stages will turn off.
- Setback is used to lower the set point when less load is required during nights and weekends.
- For setback operation, the BCP-8S can either utilize its built-in night schedule, available when Shutdown or Tstat is selected as the External Input, or an external dry contact signal to switch to setback by selecting Setback from this menu.



BURNER TYPE

On/Off, 2-Stage, 3-Stage, 4-Stage

Default: On/Off

Hold Button: MENU/<System Startup>/.../Burner Type

- The BCP-8S can sequence from a single stage and up to four stages per boiler.



TOTAL BOILERS

1 to 24

Default: varies based on Burner Type

Hold Button: MENU/<System Startup>/.../Total Boilers

- This option in combination with Burner Type Startup options will determine the total number of outputs the BCP-8S is to control.
- Use an BCP-8X for any additional stages required more than the BCP-8S has.
- If the total number of stages selected is more than the control and extension stages, the additional units containing these stages will have \square as their status and will cease to operate.



STAGING

Multiple Outputs, Single Output

Default: Multiple Outputs

Hold Button: MENU/<System Startup>/.../Staging

- Most boilers will require that the higher output stages to be energized after the lower output stages. These boilers will need to select the Multiple Output option. That means both Low and High Output stages must be energized for the boiler to function.
- Some units require that when the higher output stages are needed, the lower stages must de-energize. To operate these units, the user must select the Single Output option.



BCP-8S Installation and Operation Manual

SEQUENCE

Lo/Hi/Lo/Hi, Lo/Lo/Hi/Hi

Default: Lo/Hi/Lo/Hi

Hold Button: MENU/<System Startup>/.../Sequencing

- During low load conditions, some boilers run more efficient when the lower stages are energized alone than with the higher stages. These types of boilers should select Lo/Lo/Hi/Hi. Then, the BCP-8S will sequence the lower stages of all Automatic boilers before sequencing the higher stages.
- For the rest of the boiler types, the Lo/Hi/Lo/Hi should allow the staging of the lower stage of the lead boiler followed by the higher stage of the same boiler. Then when more stages are needed, it will fire the lower stage of the lag boiler followed by the higher stage of the lag boiler.



CONTROL LOGIC

PID, OSS (Over-Sized-System)

Default: PID

Hold Button: MENU/<System Startup>/.../Sequencing

- The PID option allows the BCP-8S to sequence stages based on Reaction Time and Boiler Min. Run Time. The PID relies on the rate of change in the system pressure. The PID logarithmic calculations foresee changes and sequence stages based on those changes. It is the most efficient operation for most heating applications.
- The Oversize option sequence stages based on how many Throttling ranges (differentials) is the system pressure away from the set point. At one Throttling range below the Set Point, only one stage will be on. For each additional Throttling range below the Set Point, an additional stage will be activated. The last stage on will be allowed to exceed the Set Point by one full Throttling range before turning off that stage. This helps to prevent the last stage from short cycling. See Throttle Range.

When PID is selected, the following are the settings that directly affect this mode of operation:

- Reaction Time SELECT *Settings/System Settings/Stage Settings/Reaction Time*
- Purge Delay SELECT *Settings/System Settings/Stage Settings/Purge Delay*
- Minimum Run Time SELECT *Settings/System Settings/Stage Settings/Min Runtime*
- Standby Delay SELECT *Settings/System Settings/Stage Settings/Standby Delay*
- Last Stage Hold SELECT *Settings/System Settings/Stage Settings/Last Stage Hold*

When Oversize (OSS) is selected, the following is the setting that directly affects this mode of operation:

- Throttle SELECT *Settings/System Settings/Stage Settings/Throttle*



SENSOR FAULT

Stages On, Stages Off

Default: Stages On

Hold Button: MENU/<System Startup>/.../Sensor Fault

- The Sensor Fault will determine the operating status of all output stages that are set to Auto or Standby when a sensor reads Short or Open.
- The Shutdown or Tstat activation will take precedence over the Sensor Fault status. That means, if Stages On is selected and the Shutdown was active, all stages will be Off on a sensor fault.
- When Stages-On is selected, the BCP-8S will turn all stages On when the System sensor reads Short or Open.
- When Stages-Off is selected, the BCP-8S will turn all stages Off when the System sensor reads Short or Open.
- The Outdoor Sensor Short or Open status will not affect the stages operation.



SETTING THE CONTROL TO FACTORY DEFAULTS

To Reset the BCP-8S control to its original factory defaults, follow the following steps:

- Power down the control.
- Hold down the two right most buttons while powering the control back up until the Total Clear Started screen appears. The Display will direct you to the Startup menu to program the control after the defaults are loaded.

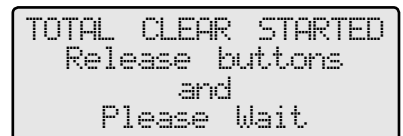

NOTE: After resetting the control to the original factory defaults, the user must go through all control settings.

▲ IMPORTANT

After performing a total reset, do not turn off power to the control until all Startup settings have been made. Otherwise, the next power-up will be set to many Startup factory settings that might not fit your application.

OPERATING SETTINGS

Can be accessed by holding down the Menu button for over three seconds.

PROGRAM CHANGE SETTINGS

To be able to change the BCP-8S settings the Program/Run Switch must be set to Program. The switch is located under the Enclosure Wiring Cover for security. The Enclosure Wiring Cover can be securely closed using a padlock.



SEASON

Winter, Summer

Default: Winter

Button: MENU/Season

- The BCP-8S will turn all boiler relays off when it is in Summer setting. The Message Display Line will read **SUMMER** to show status.
- When in Winter, the BCP-8S will activate the System relay whenever the Outdoor temperature falls to or below the Outdoor Cutoff setting. In addition, it will begin heating whenever the System pressure falls below the Set Point. The Message Display Line will not display any season information.
- When the season is over, it is a good practice to switch the BCP-8S Season setting to Summer to turn off all heating instead of turning off the control. This will preserve the battery life.

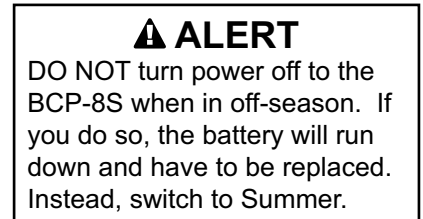

SET POINT (NOT ADJUSTABLE IN EMS MODE)

See pressure Transducer Default Settings and Ranges Table

Button: MENU/Set Point

In Set Point or EMS 4-20mA

- The Set point is the pressure value the BCP-8S will use to control the system.
- The BCP-8S will add, subtract, or hold the stages of the heating boilers to maintain the system pressure around the Set point.
- The system can be expected to oscillate around the set point. The amount of oscillation depends on the System Settings and Stage Settings.
- If an Outdoor Sensor was connected, pressing the SAVE button will switch to the Outdoor Cutoff setting option.
- If the EMS Mode was Enabled, the Set Point will be set by the EMS/BMS system and will be available as read only.
- Any value below the 2mA or above 22mA will indicate a "Shutdown by EMS" message on the Message Line.



OUTDOOR CUTOFF TEMPERATURE

Adjustable Off, 20°F/-7°C - 100°F/38°C, On

Default: 60°F/16°C

Button: MENU/Set Point/Outdoor Cutoff

in Set Point

- In Set Point mode, if the outdoor sensor is installed, the Outdoor Cutoff screen will automatically appear after the pressure Set Point has been selected.
- When the outdoor temperature falls to the adjustable Outdoor Cutoff temperature, the BCP-8S will control and sequence the boiler stages to hold the set point.
- When the outdoor temperature rises to the Outdoor Cutoff plus a 2°F differential, the BCP-8S will turn all boilers off. The System and Comb. Air relays that were energized will remain energized for the Run-On delay then de-energize.
- The Outdoor Cutoff can be set to ON or OFF. In the ON position, the System Relay will run regardless of the Outdoor temperature and the burner stages will be active to hold the set point.
- In the OFF position, the System Relay will always be off and all stages will be off as well.



SYSTEM SETTINGS

Hold Button: MENU/<System Settings>

The System Settings menu provides access to adjusting and fine-tuning the heating system for enhanced comfort and better fuel savings. The BCP-8S behaves differently based on the selected Control Modes (see Startup Settings on page 14).

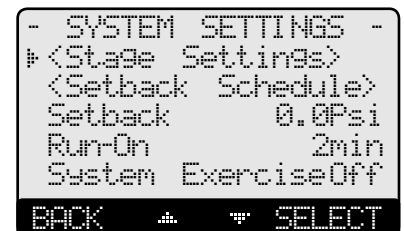

PROGRAM CHANGE SETTINGS

To be able to change the BCP-8S settings the Program/Run Switch must be set to Program. The switch is located under the Enclosure Wiring Cover for security. The Enclosure Wiring Cover can be securely closed using a padlock.

A rectangular switch with a sliding bar. The bar is currently in the 'PROGRAM' position, which is on the left. The 'RUN' position is on the right.

STAGE SETTINGS

Hold Button: MENU/<System Settings>/<Stage Settings>

REACTION TIME

Adjustable from 1 to 10 minutes

Default: 2 minutes

Hold Button: MENU/<System Settings>/<Stage Settings>/Reaction Time in PID Logic only

- Available in PID Control Logic only (See PID Operation on page 5).
- It is the amount of time it takes a single stage to affect the system.
- After the BCP-8S turns on a stage trying to meet a set point, it will not turn on another stage until the Reaction Time has elapsed. Then, it will recalculate if a stage is need.
- To determine the optimum time, in a heating system start with a hot system. Then, turn on a single stage and calculate how long it takes until the system begins to respond to that stage. That period should be set as the Reaction Time.



PURGE DELAY

Adjustable from 0.0 to 10.0 minutes

Default: 2.0 minutes

Hold Button: MENU/<System Settings>/<Stage Settings>/Purge Delay in PID Logic only

- Available in PID Control Logic only (See PID Operation on page 5).
- Most large boilers must go through a purge cycle before they are brought on line.
- When the BCP-8S activates a stage (the lowest stage on a boiler), it does not start to calculate its output until the Purge Delay is over. This allows the boiler to fully come on line and to begin producing output.
- The Purge Delay helps prevent short cycling of a newly activated boiler. Once the lowest boiler stage is activated, it MUST run through the entire Purge Delay period (see PID operation on page 5).
- The minimum Purge Delay setting MUST be set to the time required by the boiler's manufacturer specification.



MINIMUM RUNTIME

Adjustable from 1 to 60 minutes

Default: 2 minutes

Hold Button: MENU/<System Settings>/<Stage Settings>/Min Runtime in PID Logic only

- Available in PID Control Logic only (See PID Operation on page 5).
- This is the minimum amount of time any stage will run.
- For the lowest stage of a boiler, the Minimum Runtime starts after the purge cycle.
- This timer does not apply to the last stage online. The Last Stage Hold applies in that case.
- Initially, set the Minimum Runtime to half the Reaction Time.
- If System tends to overshoot, reduce the Minimum Runtime. If boilers tend to short cycle, increase Minimum Runtime.



STANDBY DELAY

Adjustable from 1 to 60 minutes

Default: 10 minutes

Hold Button: MENU/<System Settings>/<Stage Settings>/Standby Delay in PID Logic only

- Available in PID Control Logic only (See PID Operation on page 5).
- Standby boilers are used as a backup for extreme load conditions only. A Standby boiler can never be a Lead Stage. The Standby Delay only applies to boilers in Standby Mode.
- A Standby unit can only be activated after all the units in Auto Mode have run at high fire for the full Standby delay.
- The full Standby Delay must always elapse regardless of what happens to system pressure. Therefore, a shorter Standby Delay will result in smoother set point operation in extreme conditions. However, longer Standby Delays may prevent a Standby boiler from starting if the other boilers can eventually meet the load, or if the load decreases.
- When more than one boiler is set as a Standby boiler, remember that it will be added to the Reaction Time for the first stage on the first Standby boiler only. The following stages and boiler start time will rely on Pre-Purge and Reaction Time only.



LAST STAGE HOLD

See pressure Transducer Default Settings and Ranges Table

Hold Button: MENU/<System Settings>/<Stage Settings>/Last Stage Hold in PID Logic only

- Available in PID Control Logic only (See PID Operation on page 5).
- The Last Stage Hold prevents short cycling of the Lead Stage during low load conditions where the system might have a load that is significantly less than the output of one stage. When the BCP-8S brings on the Lead Stage, the Set Point is quickly exceeded, and the Lead Stage is turned off.
- To prolong the run time during this type of condition, use the Last Stage Hold setting.
- The BCP-8S will allow the system pressure to exceed the Set Point by the Last-Stage-Hold value, before the Lead Stage is turned off.
- For example, with a Set Point of 8 Psi and a Last Stage Hold setting of 2 Psi, the Lead Stage boiler will remain on, at low fire, until the system reaches 10 Psi. During that period, the display will show "Hold Until 10 Psi" then, the lead stage will turn off



THROTTLE RANGE

See pressure Transducer Default Settings and Ranges Table

Hold Button: MENU/<System Settings>/<Stage Settings>/Throttle in OSS Logic only

- Available in OSS Control Logic only (See OSS Operation on page 5).
- The Throttling Range sets a pressure band around the Set Point that controls when stages will be turned on or off.
- For example, in the OSS Control Mode, no stages will be activated until the pressure falls one full Throttling Range below the Set Point. A second stage will be activated when the pressure falls to two full Throttling Ranges below the Set Point, and so on, with one extra stage being turned on for every throttling range below the Set Point the System pressure reaches.
- Stages will be turned off as the pressure rises toward the Set Point using one full throttling range as a differential between stages.
- The last stage to be turned off will be allowed to exceed the Set Point by a full throttling range before it is turned off. This helps prevent the last stage from short cycling when the load is low or when the stage is oversized.



Set Point = 50 Psi Throttle = 5 Psi Boilers (A, B, C, D, E, and F) Lead Stage =<A>

System Pressure	Throttle Ranges	Falling Pressure		Rising pressure	
		Stages Turned On	Stages On	Stages Turned Off	Stages On
55 Psi	-1	----	None	A	None
50 Psi	0	----	None	----	A
45 Psi	1	A	A	----	A
41 - 44 Psi	1	----	A	----	A
40 Psi	2	B	A + B	B	A + B
35 Psi	3	C	A + B + C	C	A + B + C
30 Psi	4	D	A + B + C + D	D	A + B + C + D
25 Psi	5	E	A + B + C + D + E	E	A + B + C + D + E
20 Psi	6	F	A + B + C + D + E + F	F	A + B + C + D + E + F
15 Psi	7	----	A + B + C + D + E + F	----	A + B + C + D + E + F

LEAD SETTINGS

Hold Button: MENU/<System Settings>/<Stage Settings>/<Lead Settings>

The lead menu is to help in selecting the Lead boiler and the type of rotation appropriate for the system.



LEAD BOILER

Depending on the number of stages

Default: The first set of stages

Hold Button: MENU/<System Settings>/<Stage Settings>/<Lead Setting>/Rotate Mode

- The Lead Boiler's lowest stage will always be the first stage brought on when there is a call for output. As more output is needed, additional Stages are added.
- The Lead Boiler is always shown on the main display in brackets.
- In a 2-Stage system (see Burner Type in the Startup section on page 15), the display will show the two Lead Boiler stages bracketed <AB>. In a 3-Stage system, the display will show the three Lead Boiler stages bracketed <ABC>, and so on.
- The Lead Boiler can be rotated based on the Rotation Mode selected. (See next setting)



ROTATE MODE

Adjustable Time (from 1 hr to 999 hrs), Manual, FOFO **Default: Time (24Hours)**

Hold Button: MENU/<System Settings>/<Stage Settings>/<Lead Setting>/Rotate Mode

- The Lead Boiler is the first boiler brought on when output is required.
- The Lead Boiler can be rotated automatically, manually, or based on First-On/First-Off (FOFO). The automatic rotation is recommended for most applications.
- The current Lead Boiler is shown in brackets on the main display.
- Only boilers that are set to Auto Mode can be Lead. Therefore, not all the boilers may be available when manually selecting a new Lead Boiler.
- If Time is selected, a second screen will allow the adjustment of the Auto Rotate Period. If 24 Hours (default setting) was selected, the first rotation will take effect after 12 hours if the Time was not set. However, if the Time was set, the rotation will always take place at 2:00AM. The following rotations will take place every 24 hours thereafter.
- If Time Rotation was set to other than 24 hours, the rotation timer will start from the moment the setting is changed.
- If First-On/First-Off (FOFO) is selected, the concept will follow this example; if A is the lead, the starting sequence of boilers will be A, B, then C. When the de-energizing of the stages starts, it will turn off A, B, Then C. Then stage D will be the new lead for the next load.



If Time Rotation is selected

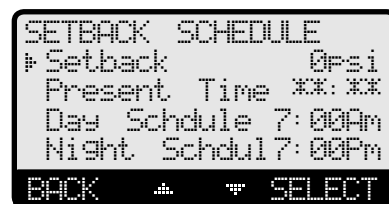

SETBACK SCHEDULE

Button: MENU/<System Settings>/<Stage Settings>/<Setback Schedule>

SETBACK

See pressure Transducer Default Settings and Ranges Table

Button: MENU/<System Settings>/<Setback Schedule>/Setback in Day/Night Schedule

Button: MENU/<System Settings>/Setback in External Signal

- The Setback feature can be used to provide the BCP-8S with a lower Set Point when less load is required during the night or on the weekends when the building is not occupied, but heat is still required.
- The new Set Point will appear on the main display indicating this condition "Setback to 5 Psi".
- For example, if in the pressure set point is 8 Psi and the Setback is 3 Psi, then when in Setback, the BCP-8S will hold a Set Point of 5 Psi.



Avoiding Conflicting Boiler Limits

- The pressure limits set on the boilers MUST be set considerably higher than the BCP-8S's Set Point for the reasons detailed below.
- The BCP-8S sensor is located in a common header some distance from the boilers.
- As the pressure rises in the header and before reaching the sensor location, energy is dissipated. Therefore, the pressure in the header could be lower than that registered by the boiler sensors.
- In addition to the normal drop experienced between the boiler's pressure and that read by the BCP-8S sensor, the Last Stage Hold setting must be accounted for. The boiler

⚠ WARNING

The temperature limits set on the boilers must be higher than the BCP-8S Set Point. Read the section at left for details that will prevent erratic system operation.

- limit must be set above the Set Point PLUS the Last Stage Hold PLUS the normal drop experienced in the piping.
- Using the previous example of a 2 Psi Last Stage Hold with a 8 Psi Set Point, the boilers' limits must be set enough over 10 Psi to prevent the boilers' internal limits being reached. In this situation, the boiler high limit should be set at approximately 12 Psi to prevent the difference in boiler pressure vs. header pressure causing erratic operation.

DAY/NIGHT SCHEDULES

Button: MENU/<System Settings>/<Setback Schedule>/Day Schedules

- The BCP-8S has two levels of heat. The Day level is used when a building is occupied and people are active.
- The Night (Setback) level is used when a building is not occupied, or when people are sleeping. This setting reduces the set point by the Setback setting. If the Day calculated pressure was 8 Psi and the Setback was 3 Psi, the Night Schedule will run at (8 Psi - 3Psi) = 5 Psi.



SET PRESENT TIME

Button: MENU/<System Settings>/<Setback Schedule>/Present Time

Button: MENU/<Maintenance>/Present Time

- The Time is used for Day/Night Schedule and History graph.
- Adjust the time by selecting Time from the menu and then scrolling through the hours followed by the minutes. If hours are to be set to PM, scroll through the AM hours to reach the PM hours.



⚠ ALERT

Remember that the battery is used as a time backup. If no power is supplied to the BCP-8S, the battery will die in three months and time clock values will be lost. Thus, DO NOT power down the control during off-season.

COMBUSTION AIR DAMPER OPERATION

The BCP-8S controls multiple relays each controlling different types of equipment. In addition to the control of the boilers, it can control a combustion air damper. See Comb. Air Damper 15.

RUN-ON

Adjustable from 0 to 60 minutes

Default: 2 minutes

Hold Button: MENU/<System Settings>/Run-On

- The Run-On applies to the System and Comb. Air relays. For the System relay, it is used to dissipate the excess energy from the boilers.
- For a combustion air damper, it brings in enough fresh air for the next boiler fire up.
- The Run-On time should be set based on the size and type of the equipment.



SYSTEM EXERCISE

Adjustable Off, On

Default: Off

Hold Button: MENU/<System Settings>/System Exercise

- The BCP-8S provides an option to exercise the System relay for 10 seconds when not used for seven days.



MAINTENANCE

Hold Button: MENU/<Maintenance>

The Maintenance menu gives access to sensor trimming. In addition, you will have access to view the Startup configuration settings as well as sensor histories



⚠ ALERT

To be able to change the BCP-8S settings the Program/Run Switch must be set to Program. The switch is located under the Enclosure Wiring Cover for security. The Enclosure Wiring Cover can be securely closed using a padlock.

BCP-8S Installation and Operation Manual

SYSTEM & OUTDOOR SENSOR TRIM

Outdoor Adjustable -20°F/-10°C to +20°F/+10°C

Default: 0°F/ 0°C

System adjustment is 10% of the selected Sensor Type range.

Hold Button: MENU/<Maintenance>/Outdoor Trim

- The Heat-Timer pressure and thermistor type sensors are very accurate, and normally require no calibration. However, sometimes it may be desirable to make small adjustments to the displayed value.
- Do not use the Trim setting to make the Outdoor sensor match the one reported on the radio or TV. Outdoor temperature can vary widely over a broadcast range.



HISTORY

Hold Button: MENU/<Histories>

The BCP-8S provides users with a graphical history of the System and Outdoor values for the previous 24 hours. The values are sampled every 12 minutes. That is, readings of pressure and temperatures are recorded and stored every 12 minutes for the last 24 hours.

- To view the values of specific period, use the two middle buttons to scroll to that time and read the upper left temperature.
- The first screen will be the System Pressure History. By clicking on the Next button, you will be able to view the Outdoor Temperature History.

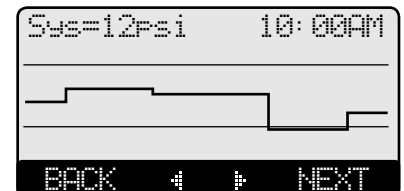

CONFIGURATION

Hold Button: MENU/<Maintenance>/<Configuration>

- This menu option provides a consolidated view of the Startup settings.
- Additional control settings will be available by selecting the NEXT option.

DISPLAY

The BCP-8S display layout provides a variety of information that gives an immediate picture of the operation status. The display shows four heating boilers at a time. The two middle buttons scrolls the screen to view additional boilers. Moreover, all the information is brightly displayed. It can be viewed in brightly or dimly lit rooms.

- The buttons' functionality changes based on the screen and menu level. The buttons' functionality is displayed on a dark background on the screen's bottom line.
- Horizontal arrows are to scroll through the available stages.
- Vertical arrows are to scroll through the menu functions when in menus or to change values of settings when in its specific screen.
- The second line from the top is the Message Display Line. In normal operation it displays the Target Set Point. However, that will be replaced by a message indicating an important status. See Display Messages on next page.
- Pressing the MENU button fast displays the User Menu.
- Pressing and holding the MENU button for more than 3 seconds displays the Installer Menu.
- Pressing the BOILER button fast displays the Boiler Menu.
- Pressing and holding the BOILER button for more than 3 seconds displays the Display Contrast Menu.

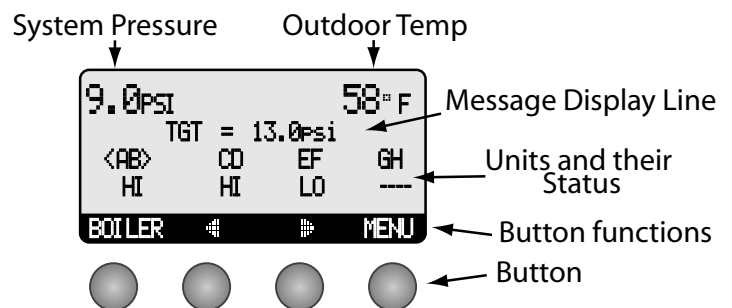

DISPLAY OUTPUT STATUS

The BCP-8S status gives immediate access to each Boiler status. The following list shows all possible boiler status:

- <AB> This is a two-stage boiler AB. It is the Lead in sequencing. (Brackets indicate Lead Stage).
- The boiler is de-energized. The Boiler Mode is set to Auto.
- STB The boiler is de-energized. The Boiler Mode is set to Standby.
- LO The lowest stage is active. Available in multi-stage boilers only. The Boiler Mode is set to either Auto or Standby.
- HI The highest stage is active. The Boiler Mode is set to either Auto or Standby.
- MED The middle stage is active. Available in Three-stage boilers only. The Boiler Mode is set to either Auto or Standby.

- MHI The mid-high stage is active. Available in Four-stage boilers only. The Boiler Mode is set to either Auto or Standby.
- MLO The mid-low stage is active. Available in Four-stage boilers only. The Boiler Mode is set to either Auto or Standby.
- ON All boiler stages are ON. The Boiler Mode is set to ON
- OFF All boiler stages are OFF or boiler does not exist. The Boiler Mode is set to OFF.
- C/E The extension panel is not communicating back to the BCP-8S. Or, more stages have been selected than the total number of control and extension stages.

DISPLAY MESSAGES

The BCP-8S normal display layout reserved the second line for message indications. The following is a list of the most common Message Display Line information:

- Summer The control is set to Summer. No heat is active.
- Outdoor Cutoff The Outdoor temperature is above the Outdoor Cutoff.
- Hold Until 12 Psi The Lead boiler is in Last Stage Hold. This example shows that the lead stage will turn off when system pressure reaches 12 Psi.
- Wait for Comb./Sys Prove The System or Combustion Air Damper relay is ON and the *PROVE* terminals are open before the lead boiler relay can energize.
- Comb./SYS Prove Failure After boilers have run for a while, Prove signal was opened. The boiler relays will de-energize. However, the System and Comb. Air relays will remain energized.
- Shutdown Active The Shutdown Terminals are Shorted. No boilers are active.
- Shutdown by EMS The EMS is below 2mA or above 22mA. No boilers are active.
- Tstat Open The Tstat Terminals are open. No boilers are active.
- Setback to 10 Psi The Target has changed to the setback value either due to Night Schedule or the *SETBACK* terminals are shorted.
- Boost to 13 Psi The Target has changed to the boost value either due to Night Schedule termination or the *SETBACK* terminals are have been opened recently.
- All Stages On/Off The System sensor is either Open or Short. The Sensor Fault stage status is active.

BOILER SETTINGS

Button: *BOILER/*

- In most installations, all active boiler adjustments are the same, but each can be configured differently if desired.
- When the BOILER button is depressed, the Boiler A Settings menu will be shown.
- Make all the appropriate settings for Boiler AB (if 2-Stage was selected as the Burner Type from the Startup on page 15).
- Then, select the Next Stage option from the menu to bring up the Boiler CD Settings menu and make all the settings. Continue until all boilers have been set.
- If a BCP-8X is connected to the BCP-8S, scrolling through stages using the Next and Previous Stage menu options will scroll through the BCP-8X stages as well.



MODE

Auto, Standby, Off, On

Default: Auto

Button: *BOILER/Mode*

- The BCP-8S only controls any boiler set to Auto or (after a delay) those set to Standby.
- Any output without an active boiler connected must be set to Off.
- The following list describes the MODE options:

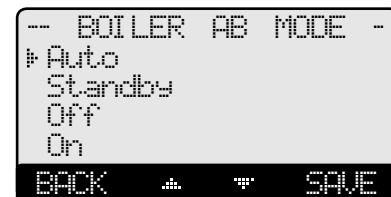

- Auto -** The BCP-8S will control the unit's operation to maintain the desired Set Point. Only units set to Auto can be lead unit.
- Standby** These units can only be activated when all units in Auto have been at HI for an adjustable Standby delay period. Standby units are generally used as a backup in extreme load conditions. Note that, a Standby unit cannot be a lead unit. Standby Delay is only available in PID mode.
- Off** Any output unit not connected to a physical unit should be set to Off. The Off Mode can also be used to disable units that are being serviced.
- On** The On Mode should only be used when testing a unit. The On Mode overrides the *PROVE* and *SHUTDOWN* inputs. Once set to On the unit will immediately start all of its stages.

BCP-8S Installation and Operation Manual

RUNTIME

Clear

Button: BOILER/Runtime

- The Runtime provides an accumulative hourly run for the selected boiler.
- The Runtime for a specific boiler can be reset to zero by pressing the middle two buttons together.



PRESSURE TRANSDUCER DEFAULT SETTINGS AND RANGES

TRANSDUCER	SET POINT			SETBACK			LAST STAGE HOLD			THROTTLE		
	MIN	MAX	DEFAULT	MIN	MAX	DEFAULT	MIN	MAX	DEFAULT	MIN	MAX	DEFAULT
15 PSI	0	15	5	0	5	0	0	3	1.5	0.25	3	0.5
30 PSI	0	30	8	0	10	0	0	6	3	0.5	6	1
100 PSI	0	100	30	0	30	0	0	20	10	1	20	2
200 PSI	0	200	60	0	60	0	0	40	20	2	40	4
300 PSI	0	300	80	0	90	0	0	60	30	3	60	6
0.250MPA	0	0.25	0.1	0	0.1	0	0	0.05	0.025	0.002	0.05	0.005
0.600MPA	0	0.6	0.2	0	0.2	0	0	0.12	0.06	0.006	0.12	0.012
1.000MPA	0	1	0.3	0	0.3	0	0	0.2	0.1	0.01	0.2	0.02
1.600MPA	0	1.6	0.5	0	0.5	0	0	0.32	0.16	0.015	0.32	0.03
30IN	0	30	10	0	10	0	0	6	3	0.5	6	1
762MM	0	760	250		250	0	0	150	80	10	150	30

Note: All Pressure and Vacuum trim ranges are approximately 10% of the Set Point Range. The factory default for any trim value is 0.

Four 2-Stage Boilers Wiring Diagram

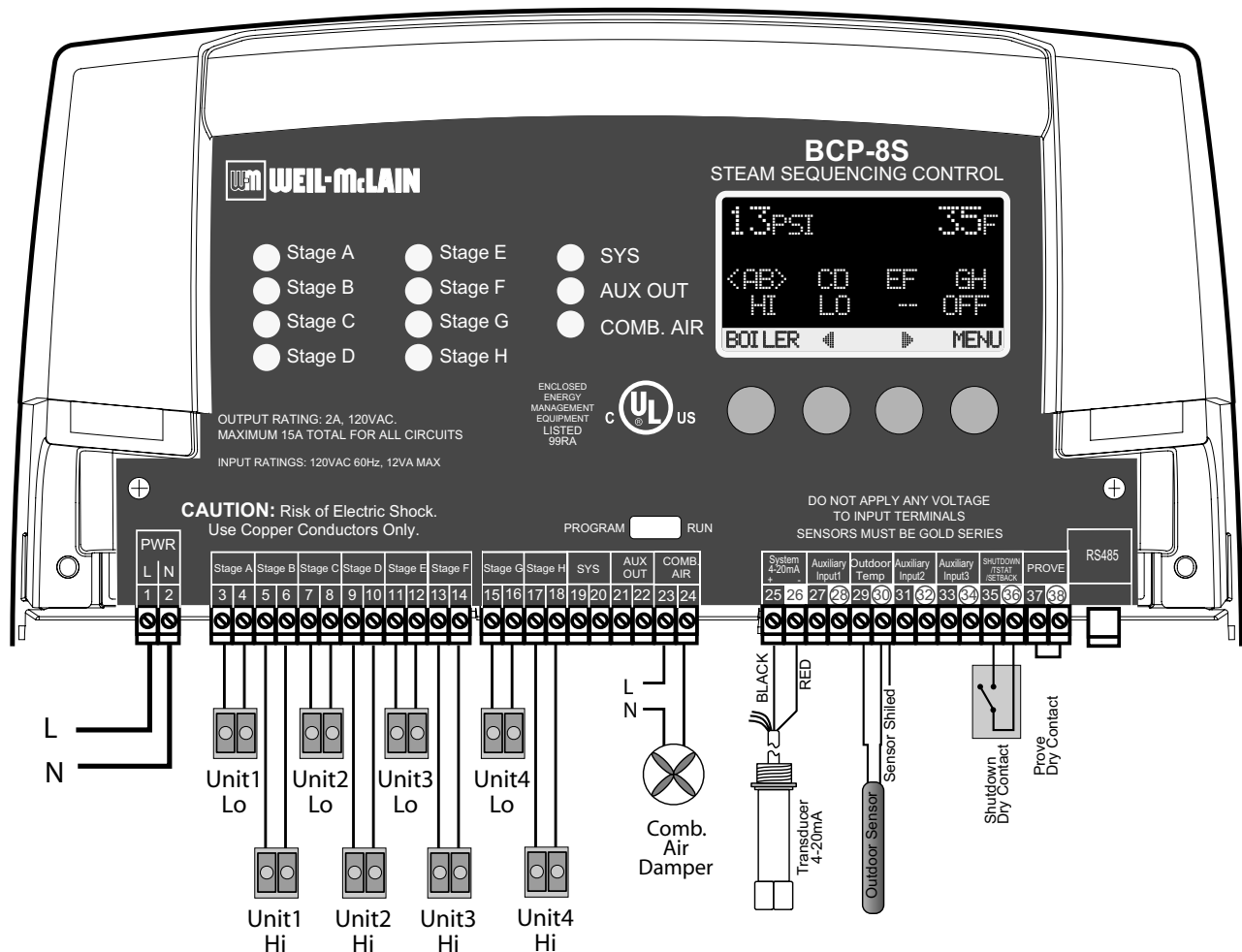

TROUBLESHOOTING

SENSOR INPUTS

Display shows Sensor OPEN or SHORT

When OPEN, Check the sensor is connected and the wires are continuous to the BCP-8S. Finally follow the procedure for Incorrect Temperature or Pressure Display. When SHORT Remove the wires from the sensor terminals. The display should change to read OPEN. If it does not, the BCP-8S may be damaged.

Display shows an Incorrect Temperature

Remove the wires from the sensor terminals. The display should change to read OPEN. If it does not, the BCP-8S may be damaged. Take an ohm reading across the detached sensor wires. The ohm reading should correspond to the Temperature sensor Table. If it does not, the sensor may be damaged.

Display shows an Incorrect Pressure

If the reading is a specified amount above or below the actual pressure adjust it using the System Trim. If reading is SHORT, remove the wires from the sensor terminals. The display should change to read OPEN. If it does not, the BCP-8S may be damaged.

CONTROL OPERATION

Too Much Heat

Check if the control has any of the following:

- **Boiler Mode Settings** - The BCP-8S will only sequence boilers their mode is set to Auto or Standby. Make sure non of the boilers have their Mode set to ON.
- **Control Settings** - The Last Stage Hold will allow only the Lead boiler to exceed the set point. If the setting is too high, and only the Lead boiler is on, the system can overshoot. Reduce the Last Stage Hold setting.

Too Little Heat

Check if the control has any of the following:

- **Setback and Day/Night Schedule** - If reduced heat occurs only during specific hours, check the Day/Night Schedule and the Setback value.
- **Boiler Mode Settings** - The BCP-8S will only control boilers their mode is set to Auto or Standby. Check if any boilers have their Mode set to Manual, Off, or Standby.

Boilers are Short-Cycling

- **Minimum Runtime** - Increase the Minimum Runtime only if all boilers tend to short-cycle.
- **Last Stage Hold** - Increase the Last Stage Hold only if the lead boiler tends to short-cycle.

System is Overshooting or Oscillating

- **Reaction Time and Minimum Runtime** - If the system is overshooting, increase the Reaction Time. This will allow the stages enough time to respond before bringing on another stage. However, if the system was oscillating, increase the Reaction Time and the Minimum Runtime.
- **PID vs OSS** - If the application the system is used on requires fast response that the normal PID mode cannot provide, try using the OSS mode and adjust the Throttle Range according to the system requirements.

Temperature Sensor Table

TEMPERATURE (in Degrees °F)	Value (in Ohms)
-30	117720
-20	82823
-10	59076
0	42683
10	31215
20	23089
25	19939
30	17264
35	14985
40	13040
45	11374
50	9944
55	8714
60	7653
70	5941
80	4649
90	3667
100	2914
110	2332
120	1879
130	1524

USER MENU SEQUENCE

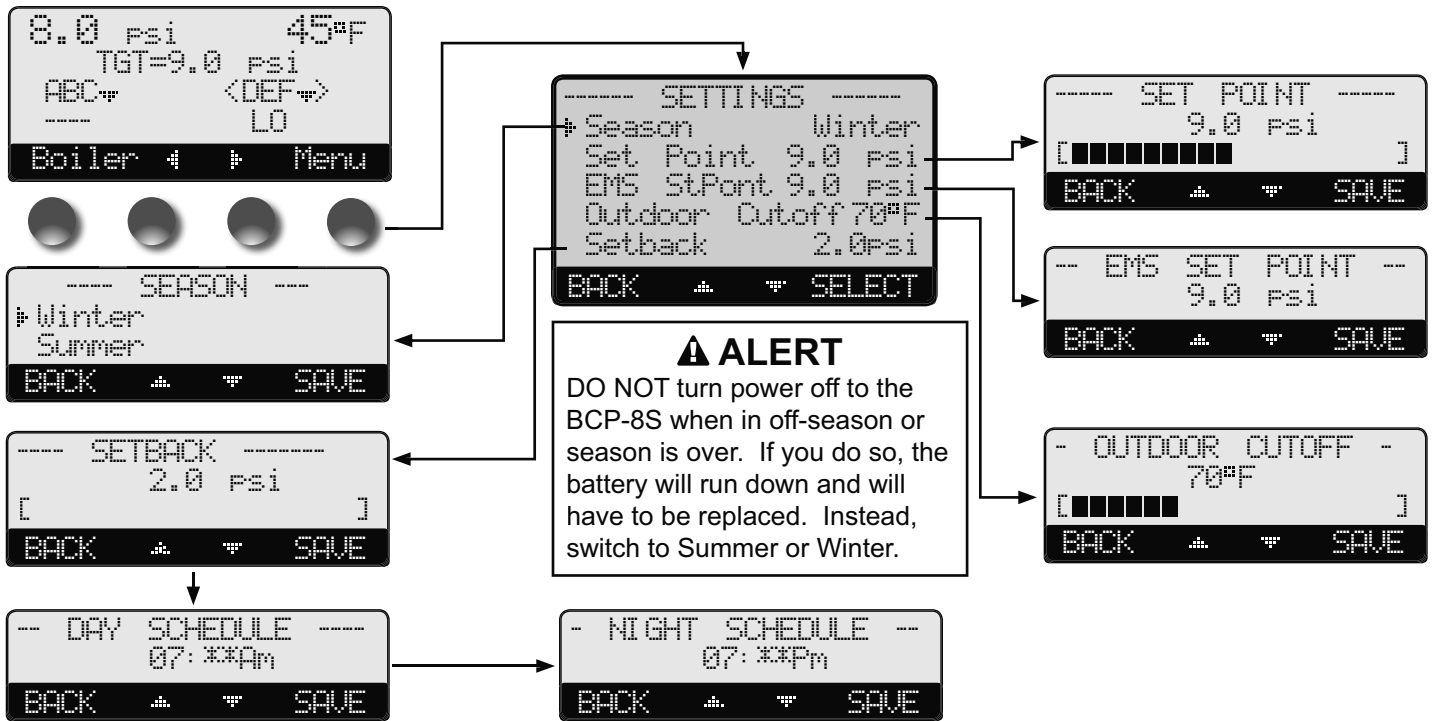

Operating users have a simplified menu that can be accessed by clicking the Menu button. Installer menu will have the same settings in addition to Startup and more advanced operation settings. The installer menu can be access by holding down the Menu button for three seconds or more.

PROGRAM CHANGE SETTINGS

To be able to change the BCP-8S settings the Program/Run Switch must be set to Program. The switch is located under the Enclosure Wiring Cover for security. The Enclosure Wiring Cover can be securely closed using a padlock.



SEASON

Button: MENU/Winter

Winter, Summer

Default: Winter

- The BCP-8S will turn all boiler relays off when it is in Summer setting. The Message Display Line will display **SUMMER** to show status.
- When in Winter, the BCP-8S will activate the System relay whenever the Outdoor temperature falls to or below the Outdoor Cutoff setting. In addition, it will begin heating whenever the System pressure falls below the Set Point. The Message Display Line will not display any season information.



SET POINT (NOT ADJUSTABLE IN EMS MODE)

For ranges and Defaults, see Set Point Table

Button: MENU/Set Point

In Set Point or EMS 4-20mA

- The Set point is the pressure value the BCP-8S will use to control the system.
- The BCP-8S will add, subtract, or hold the stages of the heating boilers to maintain the system pressure around the Set point.
- If the EMS Mode was Enabled, the Set Point will be set by the EMS/BMS system and will be available as read only.



OUTDOOR CUTOFF TEMPERATURE

Adjustable Off, 20°F/-7°C - 100°F/38°C, On

Default: 70°F/21°C

Button: MENU/Outdoor Cutoff

in Set Point

- When the outdoor temperature falls to the adjustable Outdoor Cutoff temperature, the BCP-8S will control and sequence the boiler stages to hold the set point.
- When the outdoor temperature rises to the Outdoor Cutoff plus a 2°F differential, the BCP-8S will turn all boilers off. The System and Comb. Air relays that were energized will remain energized for the Run-On delay.
- The Outdoor Cutoff can be set to ON or OFF. In the ON position, the System Relay will run regardless of the Outdoor temperature and the burner stages will be active to hold the set point.
- In the OFF position, the System Relay will always be off and all stages will be off as well.



SETBACK

See pressure Transducer Default Settings and Ranges Table

Button: MENU/<System Settings>/<Setback Schedule>/Setback **in Day/Night Schedule**

Button: MENU/<System Settings>/Setback **in External Signal**

- The Setback feature can be used to provide the BCP-8S with a lower Set Point when less load is required during the night or on the weekends when building is not occupied, but heat is still required.
- The new Set Point will appear on the main display indicating this condition "Setback to 5 Psi".
- For example, if in the pressure set point is 8 Psi and the Setback is 3 Psi, then when in Setback, the BCP-8S will hold a Set Point of 5 Psi.



DAY/NIGHT SCHEDULES

Button: MENU/<System Settings>/<Setback Schedule>/Day Schedules

- The BCP-8S has two levels of heat. The Day level is used when a building is occupied and people are active.
- The Night (Setback) level is used when a building is not occupied, or when people are sleeping. This setting reduces the set point by the Setback setting. If the Day calculated pressure was 8 Psi and the Setback was 3 Psi, the Night Schedule will run at (8 Psi - 3Psi) = 5 Psi.



SPECIFICATIONS

Voltage Input:	120 VAC 60 Hz
Power Consumption:	12 VA Max
Operating Temperature:	20°F/-7°C to 120°F/49°C
Operating Humidity:	20% to 80%
Dimensions:	11"W x 9" H x 3 3/4"
Weight:	2.5 pounds

BCP-8S Specifications:

Lead Stage Rotation:	Time (1 to 999 Hours (41 days)), Manual, First-On/First-Off
BCP-8S Outputs and LEDs:	10 N.O. S.P.S.T (8 Stages, 1 System, 1 Combustion Air)
BCP-8S Inputs:	1 System (pressure), 1 Outdoor, Ext Shutdown, Ext Tstat, Ext Setback, Prove
Stage Modes:	Auto, Standby, Off, On
Standby Time (PID only):	1 to 60 minutes
Output Built-in Relay Ratings:	2 Amp inductive (Maximum of 1/4 HP) at 120 VAC 60 Hz
Add-On BCP-8X Panels:	up two BCP-8X Panels using RS485
Pressure Display:	PSI, MPa, Vacuum Inches, Vacuum mm
Temperature Display:	Fahrenheit or Celsius.
Display:	Graphical Alphanumeric (7 rows x 21 char. each)
Temperature Sensor Ranges:	-35°F to 250°F
Outdoor Cutoff Range:	20°F/-17°C to 100°F/38°C, ON and OFF
Set Point:	Varies (See Set Point Table)
External Set Point:	Varies (See Set Point Table)
Reaction Time (PID only):	1 to 10 minutes
Minimum Run-Time (PID only):	0 to 60 minutes
Purge Delay (PID only):	0.0 to 10.0 minutes
Last Stage Hold (PID only):	Varies (See Set Point Table)
Throttle Range (OSS only):	Varies (See Set Point Table)
Run-On:	0 to 60 minutes
System Exercise:	Yes or No
Schedules:	1 Day and 1 Night (Setback) settings per day
Night Setback:	0°F/0°C to 80°F/44°C
Power Backup:	Lithium coin battery, 100 days minimum 5 year replacement (Maintains Clock in power outages).
External Inputs:	Shutdown Input, Tstat Input, Setback Input and/or Prove Input. (Dry Contacts Only)
Season:	Winter and Summer.

BCP-8X Specifications:

Extension Numbering:	Toggle Switch A or B
LED:	1 Power (Dual Color Green (A)/Red (B)), 1 Communication, 8 Stage Output relays (Dual Color Green (A)/Red (B))
Stage Outputs:	8 N.O. S.P.S.T.
Output Built-in Relay Ratings:	2 Amp inductive (Maximum of 1/4 HP) at 120 VAC 60 Hz
Connection to BCP-8S and another BCP-8X:	Two RS485



500 Blaine Street
Michigan City, Indiana 46360
219-879-6561
<http://www.weil-mclain.com>

Free Manuals Download Website

<http://myh66.com>

<http://usermanuals.us>

<http://www.somanuals.com>

<http://www.4manuals.cc>

<http://www.manual-lib.com>

<http://www.404manual.com>

<http://www.luxmanual.com>

<http://aubethermostatmanual.com>

Golf course search by state

<http://golfingnear.com>

Email search by domain

<http://emailbydomain.com>

Auto manuals search

<http://auto.somanuals.com>

TV manuals search

<http://tv.somanuals.com>