

WEST BEND AUTOMATIC BREAD AND DOUGH MAKER

RECIPES AND INSTRUCTIONS

L5225

TABLE OF CONTENTS	PAGE
Important Safeguards.....	1
Quick Start Steps for First Loaf.....	2-3
Tips on Using Machine.....	3-4
Ingredients.....	4-6
Measuring.....	6
Using Bread Mixes.....	6
Adapting Recipes.....	7
High Altitude.....	7-8
Parts Diagram.....	9
Control Panel Features.....	10-11
Making Bread.....	11-12
Making Dough.....	13
Using Time Delay.....	13
Clean Up.....	14
Troubleshooting.....	16-18
Recipes.....	20-26
Warranty.....	27

TO PREVENT PERSONAL INJURY OR PROPERTY DAMAGE, READ AND FOLLOW THE INSTRUCTIONS AND/OR WARNINGS IN THIS CARE/USE INSTRUCTIONAL MANUAL.

For your records, fill in following information on your bread maker and save dated sales receipt for warranty purposes:

Cat. Number _____ Date of Manufacture (located on back of bread maker) _____.

Date of Purchase or Received as Gift _____

IMPORTANT INFORMATION ON PROTECTING ELECTRONIC CONTROL

To protect bread maker's electronic control against possible damage caused by surges in electrical power line, we recommend using a surge protector device, available in the electronics department of most discount/hardware stores. Simply plug surge protector into electrical outlet, then plug bread maker cord into receptacle of surge protector.

IMPORTANT SAFEGUARDS

When using electrical appliances, basic safety precautions should always be followed to reduce the risk of fire, electrical shock and/or injury to persons including the following:

- Read all instructions before using.
- Do not touch hot surfaces. Use handles or knobs. Always use potholders or oven mitts to handle hot bread pan or hot bread.
- Do not put hand inside oven chamber after bread pan is removed. Heating unit will still be hot.
- To prevent personal injury or electric shock, do not place cord, plug or appliance in water or other liquid.
- Close supervision is necessary when any appliance is used by or near children.
- Unplug from outlet when not in use and before cleaning. Allow to cool before putting on or taking off parts and before cleaning appliance.
- Avoid contacting moving parts.
- Do not operate appliance with a damaged cord or plug or if the appliance malfunctions or has been damaged in any manner.
- The use of accessory attachments not recommended by The West Bend Company may result in fire, electrical shock or personal injury.
- Do not use outdoors.
- Do not let cord hang over edge of table, counter, or surface area, or touch hot surfaces.
- Do not place appliance on or near a hot gas or electrical burner, or in a heated oven.
- Do not use appliance for other than intended use.
- To disconnect power, press stop button to turn control off then remove plug from wall outlet. Never pull on the cord.
- Extreme caution must be used when moving appliance during operation.

SAVE THESE INSTRUCTIONS

Your bread maker needs no special care other than cleaning. See Warranty section in this booklet for service details. Do not attempt to repair it yourself. For Household Use Only.

An off odor from motor may be noted with first use, which is normal and will disappear with use.

Electric Cord Statement

CAUTION: Your bread maker has a short cord as a safety precaution to prevent personal injury or property damage resulting from pulling, tripping or becoming entangled with the cord. Do not allow children to be near or use this bread maker without close adult supervision. If you must use a longer cord set or an extension cord when using the bread maker, the cord must be arranged so it will not drape or hang over the edge of a countertop, tabletop, or surface area where it can be pulled on by children or tripped over. To prevent electric shock, personal injury or fire, the electrical rating of the extension cord you use must be the same or more than the wattage of the bread maker (wattage is stamped on underside of bread maker).

Important Safety Instructions

This appliance has a polarized plug (one blade is wider than the other). As a safety feature, this plug will fit in a polarized outlet only one way. If the plug does not fit fully in the outlet, reverse the plug. If it still does not fit, contact a qualified electrician. Never use with an extension cord unless plug can be fully inserted. Do not attempt to defeat this safety feature.

Your West Bend® Bread & Dough Maker was designed for use with 120 volt, 60 Hz electrical service ONLY. Use of your bread & dough maker with a converter or transformer will destroy the electronic control and will void your warranty.

‘QUICK START’ STEPS TO FOLLOW FOR MAKING THE FIRST LOAF OF BREAD

BREAD MAKING IN JUST 4 EASY STEPS

1. WHAT YOU WILL NEED

FOR MEASURING:

- See –through liquid measuring cup with graduated markings
- Set of solid, nesting type measuring cups for dry ingredients
- Set of measuring spoons
- Kitchen spoon
- Table knife

FOR MAKING BREAD:

- Milk
- Bread Flour
- Sugar
- Salt
- Butter or Margarine
- Active Dry Yeast

2. HOW TO MEASURE

Measuring ingredients the right way with the correct measuring cups and spoons is the most important step to follow when making bread. See measuring section for more information.



Always measure liquid ingredients in see-through measuring cup with graduated markings.

Liquid should just reach marking on cup at “eye level”, not above or below. For easier measuring, set cup on inside of top kitchen cabinet.



Always spoon dry ingredients, like bread flour, into solid, nesting type measuring cups, then level off with table knife.



Never scoop measuring cups into dry ingredients as this will pack down the ingredients, causing the dough to be dry and the loaf to be short.



Always use set of measuring spoons to measure smaller quantities of dry and liquid ingredients, measuring level, not rounded or heaping.

3. MAKING BASIC WHITE BREAD

- 9 ounces lukewarm milk (1 cup + 2 tablespoons), about 80°F
- 3 cups bread flour
- 1½ tablespoons sugar
- 1½ teaspoons salt
- 2 tablespoons butter or margarine
- 2 teaspoons active dry yeast

1. Put knead bar in bread pan over shaft. Twist if needed to slide down all the way.
2. Measure milk, warm gently and add to pan.
3. Measure bread flour, sugar and salt; add to pan. Level ingredients. Cut into four pieces. Place a piece in each corner on top of dry ingredients.
4. Make shallow well in center of dry ingredients; add yeast. Lock pan into machine. See directional arrow on edge of pan for which way to turn. Close cover.

4. PROGRAMMING CONTROL FOR MAKING BREAD

1. Plug cord into electrical outlet. Machine is already programmed for making **Basic** bread at the **Medium** crust setting. Red lights will appear next to Basic and Medium settings.
2. Press **Start/Stop** button to turn machine on. Bread making process will begin. Bread will be done in 3 hours and 40 minutes.
3. When done, alert will sound and Keep Warm light will glow. Turn machine off by holding **Start/Stop** button down until Keep Warm light goes out.
4. Unlock pan and remove with hot pads. Shake loaf out and place on rack to cool 15 to 30 minutes before slicing. Wash pan following cleaning instructions in this book.

OTHER TIPS TO KEEP IN MIND WHEN USING YOUR BREAD MAKER

1. **DO NOT REMOVE** the bread pan or touch any moving parts when bread maker is in operation. If you need to stop the bread maker during operation, hold the START/STOP button down for 3 seconds or until cycle light goes out.
2. **BE SURE** to allow adequate ventilation around the bread maker when it is in operation. Keep it out of drafts and direct sunlight and at least 4 inches away from walls, cabinets and other appliances, especially heating and cooling appliances which can interfere with the internal bread maker temperatures and affect the loaf of bread being prepared.
3. **DO NOT IMMERSE** base of bread pan in water or other liquid as this can damage the bearing on the bottom of the pan that turns the knead bar. See cleaning section on page 14 in this booklet for further details.
4. **ALWAYS** place bread maker on a DRY, STABLE, heatproof countertop or table during use. Since the bread maker contains a motor, some vibration occurs during the knead cycle.
5. **AVOID** touching bread maker during the bake cycle as exterior surfaces become hot. **ALWAYS** use potholders when removing and handling the bread pan after baking.
6. **FOLLOW** instructions as given for best results. **THE MOST IMPORTANT STEP IN BREAD MAKING IS TO MEASURE INGREDIENTS ACCURATELY.** See measuring section in this booklet on page 6.
7. **DO NOT EXCEED** the ingredient capacity of the bread maker. See “Know Your Ingredients: section in this booklet on pages 4 through 6. Use only fresh ingredients.
8. **ALWAYS ADD INGREDIENTS** in the order listed in the recipes. Add liquid ingredients to the bread pan first, followed by dry ingredients, then butter or margarine and finally the yeast in the very center. Before adding the yeast, **ALWAYS** tap the pan to settle the dry ingredients, then level off the ingredients, pushing into the corners to prevent liquid from seeping up. Then add the yeast to the very center of the pan, making a slight well in the center of the dry ingredients. This sequence is very important, especially when using the delay start timer of your bread maker to prevent over fermentation of the yeast.
9. **IN THE EVENT OF A POWER OUTAGE**, the bread maker will turn off automatically and remain off when power is restored. If this occurs, you will need to remove the contents from the bread pan and start over using fresh ingredients. When machine is not operating, no lights will glow in cycle column. If in time delay mode, no light will glow in time delay column if machine is not operating.
10. **DO NOT COVER** bread maker with anything during operation as this can cause malfunction.

11. DO NOT TOUCH control panel buttons after bread maker has been turned ON as this will interrupt the cycle. Turn bread maker OFF after completion of cycle.

12. DO NOT LEAVE bread maker plugged into electrical outlet when not in use to prevent it from being accidentally turned ON.

KNOW YOUR INGREDIENTS

Although bread making seems very basic, it is a science and the proportions of ingredients are critical. Read the following information to better understand the importance each ingredient plays in the bread making process. Also, always make sure your ingredients are fresh.

FLOUR is the main ingredient used in making bread and provides structure as well as food for the yeast. Several different types of flour can be used in your bread maker, but **DO NOT USE ALL-PURPOSE FLOUR, CAKE FLOUR or SELF-RISING FLOUR, AS POOR RESULTS WILL BE OBTAINED.**

Bread Flour **SHOULD** be used in your bread maker as it contains more gluten-forming proteins than all-purpose flour and will provide tall, well formed loaves with good structure. Several different brands of bread flour are available for use in your bread maker.

Whole Wheat Flour can be used in your bread maker at the special **WHOLE WHEAT** bread setting. Whole wheat flour contains the entire wheat kernel, including the bran and germ, therefore breads made with 100% or a high percentage of whole wheat flour will be lower in height and heavier in texture than bread made with bread flour. The **WHOLE WHEAT** bread setting on your bread maker features longer kneading to better develop the structure of whole wheat bread for optimum results.

Rye Flour can be used in combination with bread flour in the preparation of rye or pumpernickel bread. It cannot be used alone as it does not contain enough protein to develop adequate gluten for structure.

Special Notes on Flour: All flours are affected by growing conditions, milling, storage, humidity and even the manufacturer. While not visibly different, you may need to make some minor adjustments when using different brands of flour as well as compensating for the humidity in your area. Always store flour in an airtight container. Store whole grain flours (whole wheat, rye) in refrigerator to prevent them from becoming rancid.

Measure the amount of flour as directed in the recipe, but make any adjustments after the first 8 – 10 minutes of kneading as follows:

If dough does not form into a ball and is more like a batter in consistency, more flour will need to be added. Add 1 tablespoon of flour at a time until dough forms into a soft ball and is not sticky to the touch. If too much flour has been added and the mixture will not form into a ball, add 1 teaspoon of lukewarm water at a time, allowing the water to be kneaded into the dough before adjusting further until a soft ball of dough forms. You can typically tell by the appearance of the dough when it is just right as the dough will be soft in appearance but will not be sticky to the touch, and the sides and bottom of the bread pan will be clean.

Do not exceed 3 cups of bread flour for the 1½ pound loaf or 2 cups bread flour for the 1 pound loaf. Breads containing whole wheat, cereals or oats should not exceed a total of 3½ cups for the 1½ pound loaf; 2½ cups for the 1 pound loaf.

SUGAR AND OTHER SWEETENERS provide food for the yeast, add height and flavor to the bread and give the crust a golden color. Types of sweeteners that can be used include sugar, brown sugar, honey, molasses, maple syrup, corn syrup and fruits, whether dried or fresh. When using a liquid sweetener, such as honey or molasses, the total amount of liquid in the recipe will need to be reduced slightly by the same measurement of liquid sweetener used. A special tip when measuring sticky liquid sweeteners is to coat the measuring spoon with vegetable oil before measuring the sweetener; it will slide right out. **DO NOT USE ARTIFICIAL SWEETENERS AS A SUBSTITUTE FOR SUGAR AND OTHER NATURAL SWEETENERS AS THE YEAST WILL NOT REACT PROPERLY AND POOR RESULTS WILL BE OBTAINED.**

MILK enhances flavor and increases the nutritional value of bread. Any type of milk (whole, 2%, 1%, skim, buttermilk or canned evaporated milk) can be used in making bread. Refrigerated milk **MUST ALWAYS** be warmed to between 80° to 90° F before adding to the bread pan. Heat milk in glass measure in the microwave or in a small pan on top of the range until lukewarm, but not hot. Use a thermometer to measure the temperature accurately. **DO NOT OVERHEAT** the milk, above 110°F, as this can kill the yeast.

WATER used in combination with dry milk is a good substitute for regular milk and must be used when using the delay start timer of your bread maker as regular milk will spoil when left at room temperature for several hours.

Always use lukewarm water, between 80° and 90° for best results. Do not use warm or hot water, above 110°F, as this can kill the yeast.

Using too much liquid can cause the bread to collapse during the bake cycle. During humid weather, slightly less liquid will be needed, as the flour will absorb moisture from the air. In dry weather, slightly more liquid may be needed as flour can lose moisture.

Water and milk are interchangeable in recipes. Eliminate dry milk in recipes when substituting milk for water.

BUTTER, MARGARINE and OTHER FATS AND OILS serve several purposes in bread making as they tenderize the bread, add flavor and richness and contribute to the storage life of bread by retaining moisture. An excess of fat, however, can inhibit rising, so measure accurately.

Butter, margarine and solid shortening are interchangeable in the recipes. Butter and margarine can be used right from the refrigerator. You may wish to cut cold butter or margarine into 4 pieces for faster blending, placing them into the corners of the pan. Low-fat or fat-free bread can be made by substituting equal amounts of unsweetened applesauce or plain nonfat yogurt for the amount of fat recommended in the recipe. Watch dough as it kneads for any minor adjustments, which may be necessary.

EGGS add color, richness and leavening to bread. Use large eggs. No premixing is needed. Egg substitute can be used in place of fresh eggs. One egg equals ¼ cup of egg substitute. To reduce cholesterol, you can substitute 2 egg whites for each large egg in the recipes without affecting the end result. Watch the dough during the knead cycle as some minor adjustments may be necessary to get the dough to the right consistency. See “Special Notes on Flour” section on page 4 for adjusting dough.

A special tip when using eggs is to run them under warm water or place in a bowl of warm water about 1 minute before cracking as this helps the egg slide out of shell better.

SALT has several functions in making bread. It inhibits the yeast growth while strengthening the gluten structure to make the dough more elastic, plus it adds flavor. Use ordinary table salt in your bread maker. Using too little or eliminating the salt will cause dough to overrise; using too much can prevent the dough from rising as high as it should. Light salt can be used as a substitute for ordinary table salt providing it contains both potassium chloride and sodium. Use the same amount as recommended for table salt.

When adding salt to pan, add to one corner to keep it away from yeast, especially when using time delay as the salt can retard its growth.

YEAST is a living organism, which through fermentation, feed on carbohydrates in flour and sugar to produce carbon dioxide gas that makes the bread rise. Active dry, fast rising or bread machine yeast can be used in your bread maker. Use only the amount stated in the recipes. Using a little more can cause the dough to overrise and bake into the cover. Fast rising yeast and bread machine yeast are virtually the same and are interchangeable with one another. For best results, use fast rising or bread machine yeast at Rapid bread setting.

DO NOT USE COMPRESSED CAKE YEAST IN YOUR BREAD MAKER. RECIPES IN THIS BOOK WERE TESTED USING ONLY ACTIVE DRY, FAST RISING AND BREAD MACHINE YEAST.

Keep yeast stored in the refrigerator. You may find it handy to purchase yeast in glass jars so you can measure the exact amount you need without having to waste any. If using yeast packed in a ¼-ounce foil envelope, it is best to open a fresh envelope every time you bake. If you do save the unused amount from the open envelope, store in a dry, airtight container in the refrigerator. Date the container and use promptly. Do not mix old and new yeast in a recipe. A ½-ounce foil envelope of yeast contains 2¼ teaspoons.

ALWAYS MAKE SURE YEAST IS FRESH AND HAS NOT EXPIRED THE “USE BY” DATE PRINTED ON JAR OR ENVELOPE.

VITAL WHEAT GLUTEN is the gluten protein, which has been rinsed from wheat flour and then dried. Vital gluten will increase the protein content in flour to produce a higher loaf of bread with lighter texture. About the only time you may wish to consider adding vital gluten to recipes is for 100% whole wheat bread or recipes containing a high percentage of whole wheat or other whole grain flours or cereals. As a guideline, add one (1) teaspoon vital gluten per cup of flour used in the recipe. Check the condition of the dough during kneading as you may need to add a little water as the vital gluten will absorb

liquid. Vital gluten can be obtained at most health food stores. Do not use gluten flour, as this is not as effective as vital gluten as it contains less protein.

Or you can use a large egg as a substitute for vital gluten as it too will increase the protein content. If using an egg, add to the liquid in bottom of pan and reduce the recommended amount of liquid in recipe by two (2) ounces (¼ cup). Again, check the condition of the dough during the knead cycle for any minor adjustment that may be needed.

SPECIAL NOTE ON CINNAMON AND GARLIC: Adding too much cinnamon or garlic can affect the texture and size of the loaf obtained. Cinnamon can break down the structure of the dough, affecting height and texture, whereas, garlic can inhibit the yeast activity. Use only the amount of cinnamon and garlic recommended in the recipe: don't be generous.

**IMPORTANT IMPORTANT IMPORTANT
MEASURE INGREDIENTS PRECISELY AND ACCURATELY.**

THE MOST IMPORTANT STEP IN USING YOUR BREAD MAKER IS TO MEASURE THE INGREDIENTS PRECISELY AND ACCURATELY. A mismeasured tablespoon of water or teaspoon of salt can make a BIG difference in the bread maker. Remember, the bread maker is not human and cannot adjust for mismeasured ingredients, ONLY YOU CAN MAKE SURE THE INGREDIENTS ARE MEASURED ACCURATELY.

Follow these VERY IMPORTANT tips when measuring ingredients:

Read through the recipe and organize the ingredients you will need in the order they are added to the bread pan. Many bread disasters occur because an ingredient was left out or added twice.

Use standard kitchen measuring cups and spoons and follow the steps below.



1. ALWAYS use glass or plastic “see through” liquid measuring cups to measure liquids. Place cup on flat surface and measure at “EYE LEVEL,” not at an angle. The liquid level line **MUST** be right to the measurement marking, not above or below. A “looks close enough” measurement can spell disaster in bread making. **SPECIAL TIP:** Place liquid measuring cup on inside of kitchen cabinet for easier measuring at eye level.

2. ALWAYS use standard dry measuring cups for measuring all dry ingredients especially flour. Dry measuring cups are those that nest together. **ALWAYS SPOON DRY INGREDIENTS INTO THE SPECIFIED MEASURING CUP, THEN LEVEL OFF TOP WITH A KNIFE.** All measurements must be level. **DO NOT SCOOP** measuring cups into the dry ingredients for measuring as you will compress the ingredients into the cup and end up with more than intended which will result in a short loaf of bread.

3. ALWAYS use standard measuring spoons for measuring ingredients such as yeast, salt, sugar, dry milk, etc. as well as small amounts of honey, molasses or water. Again, the measurements **MUST BE LEVEL**, not rounded or heaping as this little bit of difference can affect the bread. **DO NOT USE TABLEWARE AS MEASURING SPOONS AS THESE VARY IN SIZE AND WILL NOT BE ACCURATE.**

USING BREAD MIXES IN YOUR BREAD MAKER

Pre-packaged bread mixes can be prepared in your bread maker. Follow the directions for making up to a 1½ pound (3 cup) loaf. Use the **BASIC** or **RAPID** Bread Setting for bread mixes unless preparing a 100% whole wheat or natural grain bread mix, which would require the use of the **WHOLE WHEAT** Bread Setting. Add the recommended amount of liquid to the bread pan first, then the flour mixture and finally the yeast on top. Select desired Crust Color and start the bread maker. The Time Delay can also be used with bread mixes providing no perishable ingredients are used, such as milk, eggs, etc., which will spoil when left at room temperature for several hours.



MAKE YOUR OWN MIXES

To save time and money, you can prepare your own bread mixes ahead of time and store in the refrigerator until ready to use. Simply measure all dry ingredients in recipes, EXCEPT YEAST, into a plastic bag and close with a twist tie. Label as to the type of bread and loaf size. When ready to use, simply add liquid ingredients to pan as recipe directs. Then add the dry mixture, level, add the butter or margarine and the yeast on top. Program and start the bread maker. Use Time Delay if recipe recommends its use.

MEASUREMENT EQUIVALENT CHART

CUP	=	FLUID OUNCE	=	TABLESPOON	=	TEASPOON
1	=	8	=	16	=	48
$\frac{7}{8}$	=	7	=	14	=	42
$\frac{3}{4}$	=	6	=	12	=	36
$\frac{2}{3}$	=	$5\frac{1}{3}$	=	$10\frac{2}{3}$	=	32
$\frac{5}{8}$	=	5	=	10	=	30
$\frac{1}{2}$	=	4	=	8	=	24
$\frac{3}{8}$	=	3	=	6	=	18
$\frac{1}{3}$	=	$2\frac{2}{3}$	=	$5\frac{1}{3}$	=	16
$\frac{1}{4}$	=	2	=	4	=	12
$\frac{1}{8}$	=	1	=	2	=	6
		$\frac{1}{2}$	=	1	=	3
		$\frac{1}{4}$	=	$\frac{1}{2}$	=	$1\frac{1}{2}$

ADAPTING YOUR FAVORITE BREAD /DOUGH RECIPES

After preparing a few of the recipes in this book, you may wish to adapt some of your favorite conventional bread recipes to the bread maker. Some experimentation will be required and you will need to check the dough during the knead cycle for any minor adjustment that may be necessary. Either use one of the recipes in this book that is similar to your recipe as a guide, or use the formula that follows:

For each cup of flour used in recipe, use:

- $\frac{1}{3}$ cup liquid
- $\frac{1}{2}$ tablespoon sweetener (sugar)
- $\frac{1}{2}$ teaspoon salt
- $\frac{1}{2}$ tablespoon fat (butter or margarine)
- $\frac{3}{4}$ teaspoon active dry yeast OR $\frac{1}{2}$ teaspoon bread machine/fast rise yeast

For example, based on the formula above using 3 cups of flour, start with:

- 1 cup liquid
- 3 cups bread flour
- $1\frac{1}{2}$ tablespoons sweetener
- $1\frac{1}{2}$ teaspoons salt
- $1\frac{1}{2}$ tablespoons fat
- $2\frac{1}{4}$ teaspoons active dry yeast OR $1\frac{1}{2}$ teaspoons bread machine/fast rise yeast

Add ingredients to pan in this order: liquid first, then all dry ingredients, except yeast. Level dry ingredients; divide fat in 4 pieces, placing a piece in each corner of pan. Make a well in center of ingredients; add yeast. Program for appropriate bread setting. After 8 to 10 minutes of kneading, check condition of dough. It should be soft, a bit sticky with a slight smear of dough in bottom of pan. If too wet and sticky, add one-tablespoon flour at a time until dough gathers into a ball and does not cling to side. If too dry and motor is laboring, add one-teaspoon liquid at a time until dough becomes soft and pliable. Do not exceed 3 cups of flour when preparing bread to prevent it from baking into the cover.

HIGH ALTITUDE ADJUSTMENT

Reduced air pressure at high altitudes causes yeast gases to expand more rapidly and the dough to rise more quickly. The dough can rise so much that when it begins to bake, it will collapse due to overstretching of the gluten. To slow the rising of dough at high altitudes, reduce the amount of yeast by $\frac{1}{4}$ teaspoon at a time until you find the right amount. You can also reduce the amount of liquid by 2 to 3 teaspoons. Some experimentation will be needed when using your bread maker at high altitudes. Make notes on the amount of yeast and liquid used for future reference.

PARTS OF BREAD MAKER

Open cover 45°, then slide forward to remove

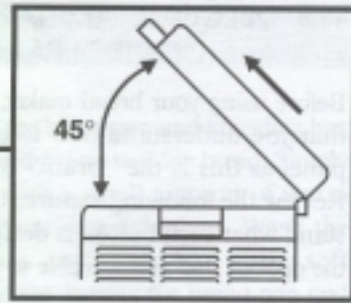
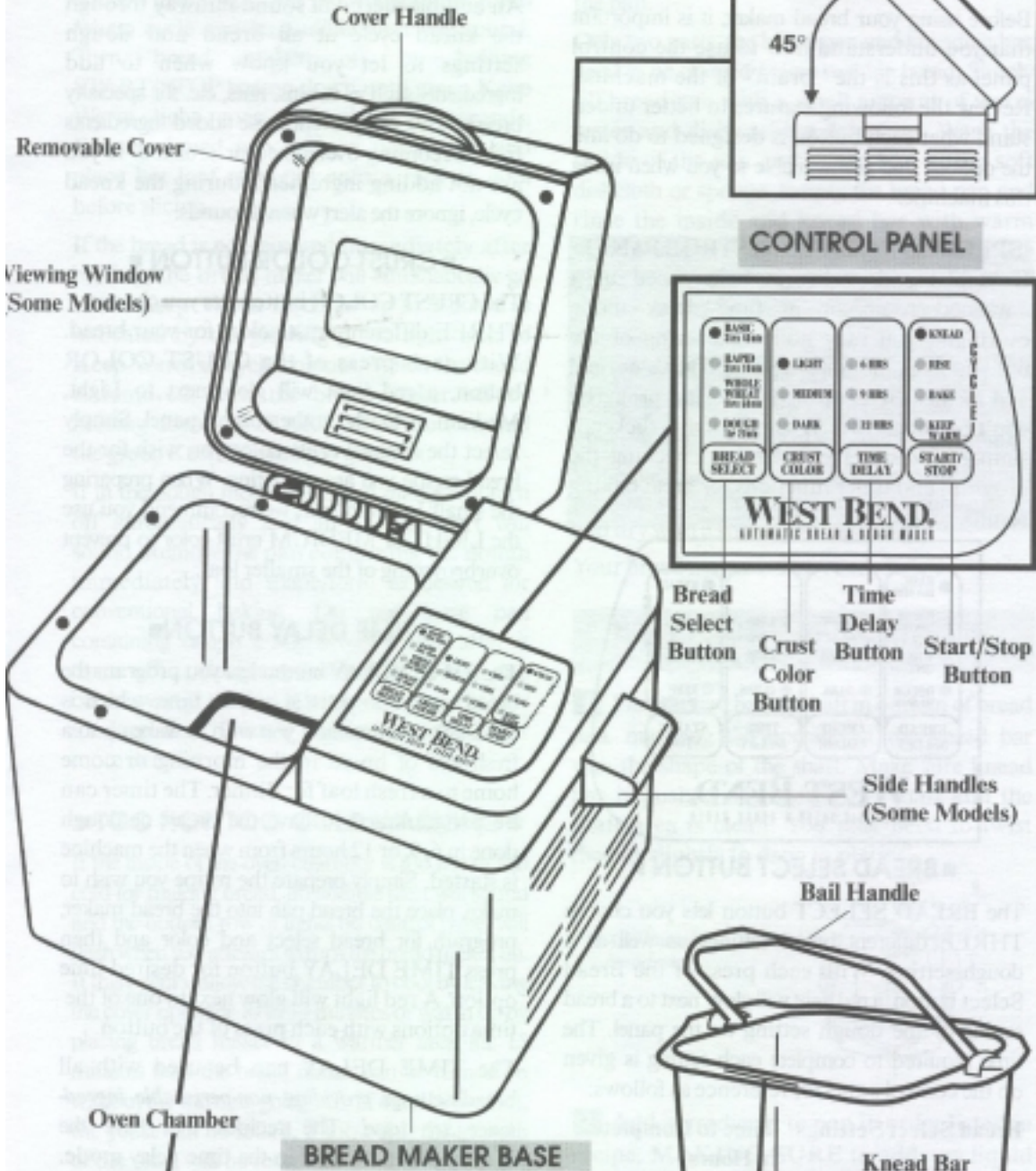

CONTROL PANEL

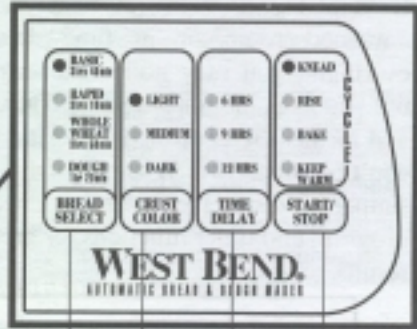

Bread Select Button Time Delay Button Start/Stop Button
Crust Color Button

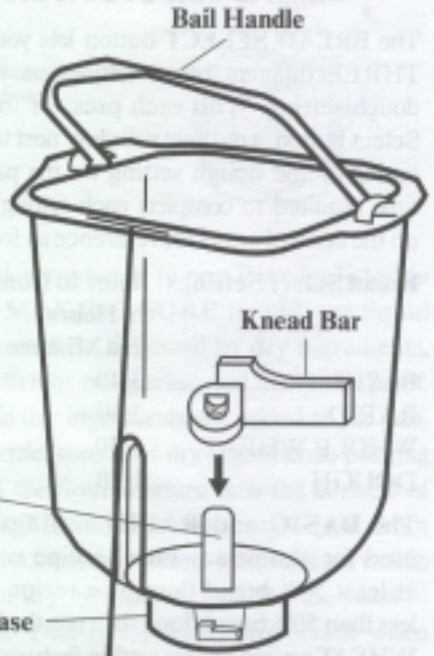
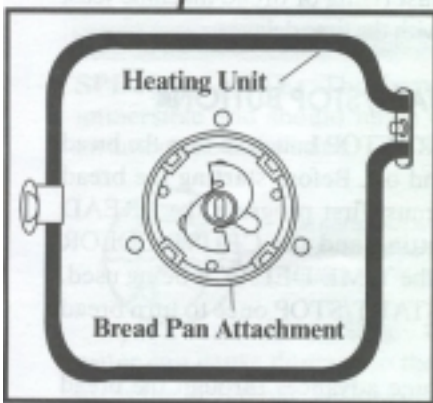

BREAD PAN

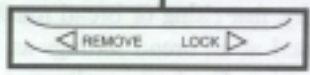

Directional Turn Arrows for Pan

BECOME FAMILIAR WITH CONTROL PANEL

Before using your bread maker, it is important that you understand how to use the control panel as this is the “brain” of the machine. Review the following features to better understand what each button is designed to do and the options that are available to you when using this machine.

SPECIAL NOTE ON CONTROL PANEL

If your bread maker is being used in a darkened room or in time delay mode overnight, you may notice flickering of the unlit lights in the control panel. **This is normal and means the control is working properly; don't be concerned.** When the lights flicker, it simply indicates the control is checking the program and timer functions for great baking results.

BREAD SELECT BUTTON

The **BREAD SELECT** button lets you choose THREE different bread setting as well as a dough setting. With each press of the Bread Select button, a red light will glow next to a bread setting or the dough setting on the panel. The time required to complete each setting is given on the control panel for reference as follows:

Bread Select Settings	Time to Complete in Hours and Minutes
BASIC.....	3:40
RAPID.....	3:10
WHOLE WHEAT.....	3:50
DOUGH.....	1:20

The **BASIC** and **RAPID** settings can be used for almost any bread recipe containing at least 50% bread flour. If a recipe contains less than 50% bread flour, then use the **WHOLE WHEAT** setting as this setting features a longer knead cycle which is beneficial for whole grain flours. Active dry, fast rising or bread machine yeast can be used at all bread settings as well as the dough setting. For best results, use fast rising or bread machine yeast at the **RAPID** setting.

An audible alert will sound midway through the knead cycle at all bread and dough settings to let you know when to add ingredients such as raisins nuts, etc. for specialty breads. This will prevent these added ingredients from becoming over mixed or crushed. If you are not adding ingredients during the knead cycle, ignore the alert when it sounds.

CRUST COLOR BUTTON

The **CRUST COLOR** button lets you choose THREE different crust colors for your bread. With each press of the **CRUST COLOR** button, a red light will glow next to Light, Medium or Dark on the control panel. Simply select the desired crust color you wish for the bread recipe you are preparing. When preparing the small 1 pound loaf, we recommend you use the **LIGHT** or **MEDIUM** crust color to prevent overbrowning of the smaller loaf.

TIME DELAY BUTTON

The **TIME DELAY** button lets you program the bread maker to start at a later time, which is especially convenient if you wish to wake up to a fresh loaf of bread in the morning or come home to a fresh loaf for dinner. The timer can be programmed to have the bread or dough done in 6,9, or 12 hours from when the machine is started. Simply prepare the recipe you wish to make, place the bread pan into the bread maker, program for bread select and color and then press **TIME DELAY** button for desired time option. A red light will glow next to one of the time options with each press of the button.

The **TIME DELAY** can be used with all bread settings providing non-perishable ingredients are used. The recipes that have the **T** symbol can be used in the time delay mode. Active dry, fast rising or bread machine yeast can be used with the time delay.

START/STOP BUTTON

Use the **START/STOP** button to turn the bread maker on and off. Before starting the bread maker, you must first program the **BREAD SELECT** setting and the **CRUST COLOR** setting plus the **TIME DELAY** if being used. Then press **START/STOP** once to turn bread maker on.

As the machine advances through the bread making process, a light will glow next to the cycle it is in, Knead, Rise or Bake. When done, a green light will glow next to the Keep Warm cycle and an audible alert will sound. Turn bread maker off by

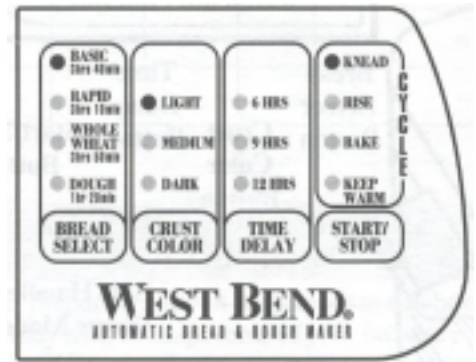

■ BREAD SELECT BUTTON ■

holding START/STOP button down until green Keep Warm light goes out, about 3 seconds. Remove bread pan using a potholder and place hot loaf of bread onto a rack to cool before slicing.

If the bread is not removed immediately after baking, the bread maker will automatically go into a **Keep Warm** mode for up to 3 hours as indicated by the glowing green light next to Keep Warm in cycle column. When the bread is removed, turn the bread maker off by holding down the START/STOP button until the green Keep Warm light goes out.

If in the dough mode, the bread maker will turn off automatically and an audible alert will sound. Remove the pan containing the dough immediately and shape/form as desired for conventional baking. Do not leave pan containing dough inside bread maker after it turns off as dough will continue to rise and could overflow the pan if left inside bread maker too long. See "Dough" section on page 13 for more details.

TOO HOT/TOO COLD WARNING

If the inside of the oven chamber is too hot or too cold for making bread, an audible alert will sound and the bottom row of lights on control panel will flash when you attempt to turn the bread maker on. If this occurs, allow the chamber to cool by leaving the cover open for 10 to 15 minutes or warm up by placing bread maker in a warmer area for 15 minutes until the bread maker can be turned on without the warning going off. If oven is too hot, the yeast can be killed, if too cold, the growth of the yeast will be retarded.

CLEAN BEFORE USING

SPECIAL NOTE: The bread pan is not immersible and should never be washed in an automatic dishwasher.



Immersing the pan in water can cause damage to the bearing that turns the knead bar. Dishwasher cleaning can reduce the non-stick qualities of the non-stick finish, causing the bread to stick in the pan.

Only two parts, the bread pan and kneading bar, need to be cleaned before making bread. Simply fill bread pan with a small amount of warm water and dishwashing detergent. Wash the inside of the pan and knead bar with a soft dishcloth or sponge. Empty the bread pan and rinse the inside and knead bar with warm water and dry with a soft cloth. Do not use any abrasive scouring pads or cleansers on bread pan or knead bar as damage to the non-stick coating can occur.

CAUTION: To prevent personal injury or electric shock, do not immerse bread maker base, its cord or plug in water or other liquid.

Wipe the inside of the chamber and the outside surfaces of the bread maker with a damp cloth and dry with a soft cloth if necessary.

Your bread maker is now ready to use.

HOW TO USE—BASIC STEPS IN MAKING BREAD

1. Place knead bar on shaft in bottom of bread pan, matching the opening of the knead bar with the shape of the shaft. Make sure knead bar is pushed down onto the shaft and the shaft area is clean. You may need to twist the bar slightly to drop in place.

2. Add ingredients to pan in order listed in recipe, **MAKING SURE** to add any liquid ingredients first, followed by dry ingredients, the butter or margarine and lastly the yeast. After the dry ingredients are added to the pan, tap to settle, then level dry ingredients, pushing some of the flour mixture into the corners of the pan. This will prevent any liquid from seeping up from the corners. Make slight well in center of dry ingredients and add the yeast to the well. This is especially important when using the Time Delay to prevent the yeast from getting wet.



3. Lock the bread pan into bread maker, turning pan counterclockwise to lock in place. Note the directional arrows on edge of pan as to which way to turn for the lock position. Pan must be locked in place for the bread maker to function properly. Make sure handle of pan is down, then close cover.



Turn pan counter-clockwise to lock pan in place.



Remove bread pan from bread maker using potholder or oven mitt. Turn pan clockwise to unlock, then lift bread pan out of bread maker.

**BREAD
SELECT**

4. Plug bread maker cord into a 120 volt AC electrical outlet **ONLY**. Press the Bread Select button until light glows next to the desired bread setting: **BASIC, RAPID, WHOLE WHEAT**. If you pass the desired setting, just continue to press the Bread Select button until desired setting is reached.

**CRUST
COLOR**

5. Press the Crust Color button until light glows next to the desired crust color: **LIGHT, MEDIUM** or **DARK**. If you pass the desired color, just continue to press the Crust Color button until desired setting is reached. Program Time Delay if desired. See instructions on page 13.

**START/
STOP**

6. Press **START/STOP** button once to turn bread maker on. When turned on, the red light next to the knead cycle will glow. The bread will begin to mix and then proceed through the cycles until done.

After the bread maker has been turned on, the programmed settings cannot be changed. If you wish to change settings, hold START/STOP button down until cycle light goes out. Then program control as desired and turn back on.

SPECIAL NOTE: An audible alert will sound midway through the knead cycle at all bread settings as a reminder to add ingredients such as raisins, fruit, nuts or cheese as directed in the recipe. Simply open the cover and add the ingredients to the dough as it is being kneaded. **DO NOT STOP THE BREAD MAKER TO ADD INGREDIENTS.** The added ingredients will be mixed into the dough during the remainder of the kneading time.

CAUTION: To prevent personal injury or burns, do not touch cover, vent or sidewalls of bread maker during the bake cycle as these surfaces are hot.

7. When the cycle is complete an audible alert will sound and green light next to Keep Warm will glow to let you know the bread is done. Turn bread maker off by holding the **START/STOP** button down until Keep Warm light goes out. Unplug cord from electrical outlet.

It is best to remove the bread immediately from bread maker for a crispy crust. Open the cover and remove the bread pan by the handle using a pot holder or oven mitt, turning the pan clockwise to unlock, then lifting the pan out of the bread maker.

Handle bread pan carefully as it is hot.

CAUTION: To prevent personal injury, always use oven mitt to remove the hot bread pan from the bread maker and when removing the baked loaf of bread from pan.

Invert bread pan and shake until loaf falls out. Place loaf of bread onto a cooling rack for at least 15 to 30 minutes for easier slicing. Knead bar will normally stay in pan when bread is removed, but may, on occasion, slide out with bread. If bar is inside bread, remove before slicing.

If bread is not removed immediately after the cycle is complete, the bread maker will automatically go into a **Keep Warm** mode for up to 3 hours. The green light next to Keep Warm will remain lit during this Keep Warm period as a reminder. When removing the bread pan during the Keep Warm period, always use pot holders or oven mitt as pan will be hot. Turn bread maker off by holding **START/STOP** button down until Keep Warm light goes out. Unplug cord from outlet after use. If the bread maker is not turned off during this 3 hour Keep Warm period, it will automatically shut itself off and the Keep Warm light will go out. Unplug cord from electrical outlet.

CAUTION: To prevent personal injury, do not put hands inside oven chamber or touch the heating unit after completion of the bake cycle as these surfaces are hot.

HOW TO USE DOUGH SETTING

The **DOUGH** setting will prepare dough for you for hand shaping/forming and baking in your own oven. Use this setting when you wish to make dinner rolls, cinnamon rolls, donuts, bread sticks or even traditional shaped loaves of bread. Time Delay **CAN** be used with the **DOUGH** setting, however, the Crust Color button **CANNOT** be used as the dough will not be baked.

Follow these steps for using the **DOUGH** setting:

1. Place knead bar on shaft in bottom of bread pan, matching the opening of the knead bar with the shape of the shaft. Make sure knead bar is pushed down onto shaft and the shaft area is clean.
2. Add ingredients to pan in order listed in recipe. **MAKING SURE** to add any liquid ingredients first, followed by dry ingredients, then butter or margarine and lastly the yeast. After dry ingredients are added to the pan, tap pan several times to settle the ingredients, then push some of the flour mixture into the corners of pan. This prevents liquid from seeping up from the corners. Make slight well in center of flour and add the yeast to well. This is especially important when using Time Delay to prevent the yeast from getting wet.
3. Lock bread pan into bread maker, turning the pan counterclockwise to lock in place. Pan must be locked in place for the bread maker to function properly. Make sure handle of pan is down, then close cover.
4. Plug bread maker cord into a 120 volt AC electrical outlet **ONLY**. Press the Bread Select button until light glows next to **DOUGH** on control. The process time for dough is 1 hour and 20 minutes. If you pass by the **DOUGH** setting, continue to press the Bread Select button until **DOUGH** is reached. Program Time Delay if desired. See instructions on pages 13.

After the bread maker has been turned on, the programmed settings cannot be changed. If you wish to change settings, hold START/STOP button down until cycle light goes out. Then program control as desired and turn back on.

5. Press **START/STOP** button once to turn bread maker on. When turned on, the red light next to knead cycle will glow. The dough will begin to mix, then be kneaded and allowed to rise before being kneaded briefly to punch down at the end of the cycle. When finished, an audible alert will sound, cycle light will go out, and machine will automatically turn itself off. Remove the dough from the pan and follow recipe directions to complete the recipe. Unplug cord from electrical outlet after cycle is complete.

HOW TO USE TIME DELAY

The Time Delay can be used at all **BREAD** settings as well as the **DOUGH** setting. Follow steps 1-5 for "Making Bread" on pages 11 and 12 or Steps 1-4 for "Making Dough" on page 13. Use only recipes with the **T** symbol with the Time Delay as these recipes contain non-perishable ingredients that will not spoil when left at room temperature for several hours before the bread or dough making process begins.

NEVER USE PERISHABLE INGREDIENTS (milk, eggs, cheese, yogurt, etc.) WITH THE DELAY START TIMER AS THESE INGREDIENTS CAN SPOIL WHEN HELD AT ROOM TEMPERATURE SEVERAL HOURS BEFORE THE BREAD MAKER TURNS ON.

After completing above mentioned steps, continue with steps below:

1. After the Bread Select and Crust Color choices have been made (with exception of Dough), select one of the three time delay options, 6, 9, or 12 hours, depending on when you want the bread or dough to be done.

TIME DELAY

For Example: If you want the bread to be done in 9 hours from when you start the machine, press **TIME DELAY** button until red light glows next to 9 hours on the control panel. The maximum amount of time that can be programmed into the time delay is 12 hours.

Keep in mind that when making bread, the machine also has a 3 hour Keep Warm mode after the bread is done, giving you even more flexibility in timing. This allows you to add up to 3 hours to any bread setting. The 3 hour Keep Warm mode applies only to bread settings, NOT THE DOUGH SETTING.

2. Press START/STOP button once to turn the bread maker on. The red light next to selected time delay setting will slowly flash to let you know the timer is working.

START/STOP If time delay is set at 9 or 12 hours, the flashing light will move to the next shortest time setting after every 3 hours. For example, if 9 hours was programmed into the time delay, the light would slowly flash at this setting for 3 hours, then advance to the 6 hour delay position. When the bread making process begins, the time delay light goes out and the cycle lights are activated for the particular cycle the machine is in, Knead, Rise and Bake.

When the bread is done, an audible alert will sound and green Keep Warm light will glow. The bread will stay warm for up to 3 hours after baking or until bread maker is turned off. Unplug cord from electrical outlet. Always use pot holder or oven mitt when removing hot bread from machine after baking. Cool loaf on rack 15 to 30 minutes before slicing.

If in Dough mode, bread maker will automatically turn itself off upon completion of the cycle when audible alert sounds. Unplug cord from electrical outlet. Remove dough from pan and finish as recipe directs.

CAUTION: To prevent personal injury, do not touch cover, vent or side walls of bread maker during the bake cycle as these surfaces are hot. Do not put hands inside oven chamber or touch the heating unit after completion of the bake cycle, as these surfaces are also hot.

SLICING BREAD

Always allow bread to cool at least 15 to 30 minutes before slicing. If you attempt to slice the bread immediately after baking, it will be very difficult to slice and will be sticky.

STORING BREAD

Since homemade bread contains no preservatives, it does not stay as fresh for as long as commercially made bread. Store your bread in a plastic bag to keep it from drying out. Keep the bread at room temperature or in the refrigerator for up to one week. For longer storage, put the bread in the freezer. Slice before freezing so you can remove only the number of slices you need at a time.

CLEAN AFTER EACH USE

SPECIAL NOTE: The bread pan is not immersible and should never be washed in an automatic dishwasher. Immersing the pan in water can cause damage to the bearing in the bottom of the pan that turns the knead bar. Dishwasher cleaning can reduce the release qualities of the non-stick finish, causing the bread to stick to the pan.

1. Unplug cord from electrical outlet.
2. The bread pan and knead bar must be cleaned after each use. After the bread is removed from pan, fill with warm water to cover the knead bar. Set pan in a dry sink or on a potholder and allow pan and knead bar to soak for 5 to 10 minutes. Then lift bar off shaft, twisting slightly if needed to unlock. **The knead bar must be allowed to soak in water before it can be removed.**

Add small amount of dishwashing detergent to the pan and wash the inside and knead bar with a soft cloth or sponge. Empty pan and rinse inside as well as knead bar with warm water and dry with a soft cloth. Always make sure the shaft in the bottom of the pan is kept clean. Do not use any type of utensil or tool to clean the gasket around the shaft in bottom of pan as damage will occur and result in leakage.

Do not use any abrasive scouring pads or cleansers on bread pan or knead bar as damage to the non-stick coating can occur.

The coating on the inside of the bread pan may change color over time, which is normal and does not affect the bread or dough prepared.

CAUTION: To prevent personal injury or electric shock, do not immerse bread maker base, its cord or plug in water or other liquid.

3. Wipe inside chamber and outside surfaces of bread maker with a damp cloth and dry with a soft cloth if necessary. Cover can be removed for cleaning. Open cover 45 degrees, then slide forward. Wipe cover with a damp soapy cloth and dry. Do not immerse cover in water or place in automatic dishwasher for cleaning as water will get in between the parts and can cause damage.

After cleaning, replace cover by aligning attachment bar into hinge on back of bread maker. Cover should move freely up and down after being replaced.

BREAKDOWN OF BREAD/DOUGH CYCLES

So you know exactly what is going on inside the bread maker during the process time, the following chart breaks down the time in minutes or seconds that each cycle requires. These times are approximate and should be used only as a guide. The total process time is also given in hours and minutes, depending on the bread settings.

	BASIC	RAPID	WHOLE WHEAT	DOUGH
Cycles:				
KNEAD	6 min.	6 min.	6 min.	26 min
RISE	15 min.	15 min.	15 min.	54 min.
KNEAD	20 min.	20 min.	30 min.	15 sec.
RISE	44 min.	29 min.	50 min.	----
KNEAD	15 sec.	15 sec.	15 sec.	----
RISE	25 min.	10 min.	15 min.	----
KNEAD	15 sec.	15 sec.	15 sec.	----
RISE	50 min.	50 min.	55 min.	----
BAKE	60 min.	60 min.	60 min.	----
KEEP WARM	3 hrs.	3 hrs.	3 hrs.	----
Total Time To Make Bread	3 hrs 40 min.	3 hrs. 10 min.	3 hrs. 50 min.	----
Total Time For Dough				1 hr. 20 min.

KNEAD When the bread maker is turned on, it will mix and knead the ingredients for 6 minutes. The knead bar will start and stop every few seconds during the beginning of mixing action which is normal

RISE After the initial mixing/kneading period, the dough is allowed to rise for 15 minutes before the final kneading action begins when using the bread settings. You may hear faint clicking sounds during this period which is normal and indicates the bread maker is working properly on keeping the dough warm. (When set at the DOUGH setting, this cycle is omitted as it is not necessary in the preparation of dough for hand shaping and baking.)

KNEAD The total knead time varies depending on the bread selection made. Total kneading time at the BASIC, RAPID, and DOUGH settings is 20 minutes; 30 minutes for the WHOE WHEAT bread setting. The longer knead time is required at the WHOLE WHEAT setting to better develop the gluten in whole wheat flour.

SPECIAL NOTES:

- When using any setting, an audible alert will sound midway through the second Knead cycle to let you know when to add ingredients such as raisins, nuts, cheese, etc. to prevent overmixing or crushing of added ingredients. If you are not adding ingredients to the recipe, ignore this alert.
- If you need to make any adjustments to the recipe, such as adding a little more flour or liquid in order to improve the consistency of the dough, you must make this adjustment during this knead period. You may wish to use the add ingredient alert or set a separate timer to remind you to check the dough during the kneading period to make any necessary adjustments. See page 4 for further details.

RISE After the dough is kneaded, it is allowed to rise for a certain period of time. You may hear faint clicking sounds during the rise as gentle heat is being provided to keep the chamber warm.

- KNEAD** After the dough has risen, it is then stirred down briefly by the knead bar to remove excess carbon dioxide gas created by the yeast.
- SPECIAL NOTE:**
- If using the DOUGH setting, its cycle is complete at this time and ready for hand shaping , rising and baking in your own oven. An audible alert will sound and the bread maker will turn itself off after completion of the DOUGH cycle.
- RISE** The dough is then allowed to rise again, but for a shorter period of time.
- KNEAD** After the shorter rise time, the dough is again stirred down by the knead bar to remove excess gas and also to shape the dough into a ball for the final rise. This final knead ensures that the bread will have good texture.
- RISE** The dough then goes into the final rise to achieve its maximum height. Again, you may hear faint clicking sounds during the rise as gentle heat is provided to keep the chamber warm.
- BAKE** The bread is then baked. An audible alert will sound when the bread is done and green Keep Warm light will glow. When the bread is removed, turn bread maker off by holding down the START/STOP button until Keep Warm light goes out, about 3 seconds.

TROUBLESHOOTING GUIDE

Following are some typical problems that can occur when making bread in your bread maker. Please review the problems, their possible causes and the corrective action that should be taken to ensure successful bread making.

PROBLEM	POSSIBLE CAUSE	SOLUTION
1. Top inflated, mushroom-like in appearance	Too much yeast.	Reduce yeast by ¼ to ½ teaspoon.
	Too much sugar.	Reduce sugar by 1 teaspoon.
	Too much flour.	Reduce flour by 2 to 3 tablespoons.
	Substituted bread machine/fast-rising yeast for amount given for active dry yeast.	Use correct amount of bread machine/fast machine/fast rising yeast.
	Not enough salt.	Use amount of salt recommended in recipe.
	Warm, humid weather.	Reduce liquid by 1 tablespoon and reduce yeast by ¼ to ½ teaspoon.
2. Top and sides cave in.	May be caused from baking in high altitude.	Make recommended adjustment for high altitude baking by reducing yeast by ¼ teaspoon and reducing liquid by 2 to 3 teaspoons.
	Too much liquid.	Reduce liquid by 1 tablespoon.
	Too much yeast.	Use amount recommended in recipe.
3. Center of loaf is raw, not baked through.	Too much liquid.	Reduce liquid by 1 tablespoon.
	Power outage during	If power goes out during operation bread maker will be turned off automatically. You will need to remove unbaked loaf from pan and start over with fresh ingredients.
	Forgot to put knead bar in pan.	Always make sure knead bar is on shaft in bottom of pan before adding ingredients.

TROUBLESHOOTING(continued)

4. Gnarly, knotted top	Not enough liquid. Too much flour.	Increase liquid by 1 tablespoon. Measure flour accurately, leveling off measuring cup.
5. Dark crust color	Dark crust setting used.	Use Light or Medium crust color setting the next time.
6. Loaf of bread is burned.	Bread maker malfunctioning	See Warranty section for service information.
7. Crust too thick.	Bread baked too long.	Use lighter crust color setting the next time to shorten bake time.
8. Knead bar cannot be removed	You must add water to bread pan and allow knead bar to soak before it can be removed.	Follow cleaning instructions after use.
9. Flat loaves,	Yeast omitted.	Assemble ingredients as listed in recipe.
	Yeast too old	Check expiration date.
	Liquid too hot	Use lukewarm liquid,80°-90°F.
	Too much salt added.	Use amount recommended.
	Sugar or other sweetener omitted.	Assemble ingredients as listed in recipe.
	If using timer, yeast got wet before bread making process started.	Push dry ingredients into corners of pan and make of pan and make slight well in center of dry ingredients for yeast to protect it from liquids.
10. Short loaves. (Under 5 inches)	Typical for 1 pound loaves and recipes using whole wheat flour.	Normal situation, no solution.
	Not enough liquid.	Increase liquid by 1 tablespoon.
	Sugar omitted or not enough added.	Assemble ingredients as listed in recipe.
	Wrong type of flour used.	Do not use all-purpose flour.
	Not enough yeast used or too old.	Measure amount recommended and check freshness date on package.
	Wrong type of yeast used.	Use correct type of yeast, especially important for bread machine/fast-rising yeasts.
11. Collapsed while baking.	May be caused from baking in high altitude.	Make recommended adjustment for high altitude baking by reducing yeast by ¼ teaspoon and reducing liquid by 2 to 3 teaspoons.
	Exceeding capacity of bread pan.	Do not use more ingredients than for a 1½ pound loaf.
	Not enough salt used or omitted.	Use amount of salt recommended in recipe.
	Too much yeast or wrong type used.	Measure right type of yeast accurately.

TROUBLESHOOTING(continued)

	Warm, humid weather.	Reduce liquid by 1 tablespoon and reduce yeast by reduce yeast by ¼ to ½ teaspoon.
12. Bread doesn't slice well,	Sliced while too hot.	Allow bread to cool on rack at least 15 to 30 minutes before slicing to release steam.
	Not using proper knife.	Use a good bread knife or electric knife.
13. Open, coarse, holey texture.	Salt omitted.	Assemble ingredients as listed in recipe.
	Too much yeast.	Measure right amount of recommended yeast.
	Too much liquid.	Reduce liquid by 1 tablespoon.
14. Heavy, dense texture.	Too much flour.	Measure accurately, leveling off measuring cup.
	Not enough yeast.	Measure right amount of recommended yeast.
	Not enough sugar.	Measure accurately. See page 6.
15. Ingredients not mixed.	Did not start breadmaker.	After programming control panel, press START/STOP button to turn bread maker on.
	Forgot to put knead bar in pan.	Always make sure knead bar is on shaft in bottom of pan before adding ingredients.
16. Burning odor noted during operation.	Ingredients spilled inside oven.	Be careful not to spill ingredients when adding to pan. Ingredients can burn onto heating unit and smoke.
	Pan leaks.	Obtain replacement. Replacement pan may be ordered. See Warranty section.
	Exceeding capacity of bread pan.	Do not use more ingredients than recommended in recipe and always measure ingredients accurately. See page 6.
17. Bread sticks to pan.	Can happen over prolonged use.	Wipe inside of bread pan, from ribs down, lightly with vegetable oil or solid shortening. Or add 1 teaspoon vegetable oil to liquid in pan before adding dry ingredients. Do not use a vegetable spray as sticking can worsen. Or, let bread sit in pan 10 minutes before shaking out. Replacement pan may be ordered. See Warranty section.
18. Whoops! Machine unplugged by mistake or power lost during use. How can I save the Bread?	If machine in knead cycle, reprogram to the same bread setting and color and turn machine back on. If machine in rise cycle, remove dough from pan, shape and place in greased 9x5-inch loaf pan, cover and allow to rise until doubled. Bake in preheated conventional oven at 350° for 40 to 45 minutes or until golden brown. If machine is in bake cycle, preheat conventional oven to 350° and remove top rack. Carefully remove pan from machine and place on bottom rack in oven. Bake until golden brown.	

NUTRITIONAL INFORMATION

Nutritional information is based on a ½-inch thick slice of bread from a 1½ pound loaf.

The following nutritional information was calculated using butter and whole milk when called for in the recipes. For less calories and total fat, you may substitute margarine for butter and low-fat milk for whole milk.

Country White Bread Total Calories:147.8,Total Fat(g):2.6, Total Carb(g):26.1, Total Protein(g):5.0, Fiber(g):0.9, Chol(mg):5.8, Sodium(mg):344.2

Classic Rye Bread Total Calories: 137.6, Total Fat(g): 1.8, Total Carb(g): 26.2, Total Protein(g): 4.3, Fiber(g): 2.1, Chol(mg): 3.4, Sodium(mg): 194.9

Raisin Bread Total Calories: 201.2, Total Fat(g): 6.0, Total Carb(g): 32.4, Total Protein(g): 6.2, Fiber(g): 1.7, Chol(mg): 6.8, Sodium(mg): 298.8

Honey Oatmeal Bread Total Calories:128.4, Total Fat(g): 2.4, Total Carb(g):23.4, Total Protein(g):4.0, Fiber(g):1.0, Chol(mg): 5.1, Sodium(mg): 268.5.

French Bread Total Calories: 159.8, Total Fat(g): 1.7, Total Carb(g): 30.3, Total Protein(g): 5.4, Fiber(g): 1.1. Chol(mg): 2.8, Sodium(mg): 237.1

Egg Bread Total Calories: 150.2, Total Fat(g): 5.1, Total Carb(g):22.4, Total Protein(g): 4.4, Fiber(g): 0.9 Chol(mg):7.7 Sodium(mg): 236.9

100% Whole Wheat Bread Total Calories:153.0, Total Fat(g):3.0, Total Carb(g):26.9, Total Protein(g):5.4, Fiber(g):4.0, Chol(ml):6.5, Sodium(mg):299.0

Half Whole Wheat Bread Total Calories: 149.6. Total Fat (g): 2.9, Total Carb(g): 26.4, Total Protein(g): 5.0, Fiber(g): 2.2, Chol(mg): 6.5, Sodium(mg): 297.5

Basic Dinner Rolls/Bread Sticks Per roll- Total Calories: 59.6, Total Fat(g): 1.5, Total Carb.(g): 9.8, Total Protein(g): 1.9, Fiber(g):0.3, Chol(mg): 3.7, Sodium(mg): 74.5

Cinnamon Rolls Per roll- Total Calories: 304.2, Total Fat(g): 14.2, Total Carb(g): 38.5, Total Protein(g): 9.1, Fiber(g): 1.5, Chol(mg): 45.6, Sodium(mg): 203.7

Pizza Dough. Per1/12th of pie. Does not include toppings- Total Calories: 117.4, Total Fat(g): 3.2, Total Carb(g): 18.5, Total Protein(g):3.2, Fiber(g): 0.9. Chol(mg): 0.2, Sodium(mg): 178.2

Whole Wheat Pizza Dough. Per 1/12th of pie. Does not include toppings- Total Calories:100.53, Total Fat(g): 2.1. Total Carb(g): 16.9, Total Protein(g): 3.3, Fiber(g): 2.8, Chol(mg): 0.2, Sodium(mg): 199.1

FOLLOW THESE INSTRUCTIONS FOR RECIPES ON THIS PAGE

Bread Select Setting To Use: Basic or Rapid

1. Add liquid ingredients to pan.
2. Add dry ingredients, except yeast, to pan. Tap pan to settle dry ingredients, then level ingredients, pushing some of the mixture into the corners. Place butter into corners of pan.
3. Make a well in center of dry ingredients; add yeast. Lock pan into bread maker.
4. Program for BASIC or RAPID and desired Crust Color. Program TIME DELAY if being used. Start bread maker. When done, turn off and remove bread from pan. Cool on rack before slicing.

**If making a 1 pound loaf, use Light Crust Color setting to prevent overbrowning of the smaller loaf.

COUNTRY WHITE BREAD [Ⓟ]		
1 Pound Loaf**	INGREDIENTS	1½ Pound Loaf
6 ounces (¾ cup)	Water, 80-90°F	8½ ounces (1 cup + 1 Tbsp.)
2 cups	Bread Flour	3 cups
1 tablespoon	Dry Milk	2 tablespoons
1½ tablespoons	Sugar	2 tablespoons
1 teaspoon	Salt	1½ teaspoons
1 tablespoon	Butter or Margarine	2 tablespoons
1½ teaspoons	Active Dry Yeast	2 teaspoons
-or-	-or-	-or-
1 teaspoon	Bread Machine/ Fast Rise Yeast	1½ teaspoons
CLASSIC RYE BREAD [Ⓟ]		
1 Pound Loaf**	INGREDIENTS	1½ Pound Loaf
5½ ounces (⅔ cup)	Water, 80-90°F	8½ ounces (1 cup + 1 Tbsp.)
1⅓ cups	Bread Flour	2 cups
⅔ cup	Medium Rye Flour	1 cup
2 teaspoons	Dry Milk	1 tablespoon
1½ tablespoons	Sugar	2 tablespoons
½ teaspoon	Salt	1 teaspoon
1 teaspoon	Caraway Seed(optional)	2 teaspoons
2 teaspoons	Butter or Margarine	1 tablespoon
1½ teaspoons	Active Dry Yeast	2 teaspoons
-or-	-or-	-or-
1 teaspoon	Bread Machine/ Fast Rise Yeast	1½ teaspoons
HONEY OATMEAL BREAD [Ⓟ]		
1 Pound Loaf**	INGREDIENTS	1½ Pound Loaf
5½ ounces(⅔ cup)	Water, 80-90°F	8 ounces (1 cup)
2 tablespoons	Honey	3 tablespoons
1½ cups	Bread Flour	2¼ cups
⅔ cup	Oats, quick or old- fashioned	1 cup
1 tablespoon	Dry Milk	1½ tablespoons
¾ teaspoon	Salt	1¼ teaspoons
1 tablespoon	Butter or Margarine	1½ tablespoon
1½ teaspoons	Active Dry Yeast	2 teaspoons
-or-	-or-	-or-
1 teaspoon	Bread Machine/ Fast Rise Yeast	1½ teaspoons

FOLLOW THESE INSTRUCTIONS FOR BOTH RECIPES ON THIS PAGE

Bread Select Setting To Use: Basic or Rapid

1. Add liquid ingredients to pan,
2. Add dry ingredients, except yeast, to pan. Tap pan to settle dry ingredients, then level ingredients, pushing some of the mixture into the corners. Place butter into corners of pan.
3. Make a well in center of dry ingredients; add yeast. Lock pan into bread maker.
4. Program for BASIC or RAPID and desired Crust Color. Program TIME DELAY if being used. Start bread maker. When done, turn off and remove bread from pan. Cool on rack before slicing.

**If making a 1 pound loaf, use Light Crust Color setting to prevent overbrowning of the smaller loaf.

FRENCH BREAD [Ⓟ]		
1 Pound Loaf**	INGREDIENTS	1½ Pound Loaf
7 ounces (¾cup+ 2 Tbsp)	Water, 80-90°F	9½ ounces(1 cup + 3 Tbsp)
2½ cups	Bread Flour	3½ cups
1 teaspoon	Sugar	1½ teaspoons
¾ teaspoon	Salt	1¼ teaspoons
1½ teaspoons	Butter or Margarine	1 tablespoon
1 teaspoon	Active Dry Yeast	2 teaspoons
-or-	-or-	-or-
¾ teaspoon	Bread Machine/ Fast Rise Yeast	1½ teaspoons

EGG BREAD		
1Pound Loaf**	INGREDIENTS	1½ Pound Loaf
5½ ounces (⅔ cup)	Milk, 80-90°F	5½ ounces (⅔ cup)
1	Egg, large	2
2¼ cups	Bread Flour	3 cups
1 teaspoon	Salt	1½ teaspoons
1½ tablespoons	Sugar	2½ tablespoons
1 tablespoon	Butter or margarine	1½ tablespoons
1½ teaspoons	Active Dry Yeast	2 teaspoons
-or-	-or-	-or-
1 teaspoon	Bread Machine/ Fast Rise Yeast	1½ teaspoons

FOLLOW THESE INSTRUCTIONS FOR RECIPE ON THIS PAGE

Bread Select Setting To Use: Basic or Rapid

1. Add liquid ingredients to pan.
2. Add dry ingredients, except yeast, to pan. Tap Pan to settle dry ingredients, then level ingredients, pushing some of the mixture into the corners. Place butter into corners of pan.
3. Make a well in center of dry ingredients; add yeast. Lock pan into bread maker.
4. Program for BASIC or RAPID and desired Crust Color. Program TIME DELAY if being used. Start bread maker. When alert sounds during Kneading period, add raisins and nuts for Raisin Bread recipe. Close cover. When done, turn off and remove bread from pan. Cool on rack before slicing.

**If making a 1 pound loaf, use Light Crust Color setting to prevent over browning of the smaller loaf.

***SPECIAL TIP: To make raisin bread overnight or without being present to add the raisins or without being present to add the raisins and nuts, follow Steps 1-3 above. Then place raisins and nuts around the side of pan, **away** from the yeast. Do not add raisins to the water in pan as the raisins will absorb too much liquid and a poor loaf of bread will be obtained. Continue with Step 4.

RAISIN BREAD ① ***		
1 Pound Loaf**	INGREDIENTS	1½ Pound Loaf
7 ounces(¾cup + 2 Tbsp)	Water, 80-90°F	8½ ounces(1 cup+ 1 Tbsp)
2 cups	Bread Flour	2¾ cups
1 tablespoon	Dry Milk	2 tablespoons
1 tablespoon	Sugar	1½ tablespoons
1 teaspoon	Salt	1½ teaspoons
½ teaspoon	Cinnamon	1 teaspoon
1 tablespoon	Butter or Margarine	2 tablespoons
1½ teaspoons	Active Dry Yeast	2 teaspoons
-or-	-or-	-or-
1 teaspoon	Bread Machine/ Fast Rise Yeast	1½ teaspoons
½ cup	Raisins	¾ cup
¼ cup	Chopped Nuts(optional)	½ cup

FOLLOW THESE INSTRUCTIONS FOR BOTH RECIPES ON THIS PAGE

Bread Select Setting To Use: Whole Wheat

1. Add liquid ingredients to pan.
2. Add dry ingredients, except yeast, to pan. Tap pan to settle dry ingredients, then level ingredients, pushing some of the mixture into corners. Place butter into corners of pan.
3. Make a well in center of dry ingredients; add yeast. Lock pan into bread maker.
4. Program for WHOLE WHEAT and desired Crust Color. Program TIME DELAY if being used. Start bread maker. When done, turn off and remove bread from pan. Cool on rack before slicing.

**If making a 1 pound loaf, use Light Crust Color setting to prevent over browning of the smaller loaf.

100% WHOLE WHEAT BREAD		
1 Pound Loaf**	INGREDIENTS	1½ Pound Loaf
5 ounces(½cup + 2 Tbsp)	Water, 80-90°F	7½ ounces(¾cup + 3 Tbsp)
1	Egg, large	1
2 teaspoons	Molasses	1 tablespoon
2 teaspoons	Honey	1 tablespoon
2⅓ cups	Whole Wheat Flour	3¼ cups
1 tablespoon	Dry Milk	1½ tablespoons
1 teaspoon	Salt	1½ teaspoons
1½ tablespoons	Butter or Margarine	2 tablespoons
1½ teaspoons	Active Dry Yeast	2 teaspoons
-or-	-or-	-or-
1 teaspoon	Bread Machine/ Fast Rise Yeast	1½ teaspoons

HALF WHOLE WHEAT BREAD [Ⓟ]		
1 Pound Loaf**	INGREDIENTS	1½ Pound Loaf
6 ounces (¾ cup)	Water, 80-90°F	8½ ounces(1 cup+ 1 Tbsp)
2 teaspoons	Honey	1 tablespoon
1 cup	Bread Flour	1½ cups
1 cup	Whole Wheat	1½ cups
1 teaspoon	Salt	1½ teaspoons
1 tablespoon	Brown Sugar, packed	1½ tablespoons
1 tablespoon	Dry Milk	1½ tablespoons
1 tablespoon	Butter or Margarine	2 tablespoons
1½ teaspoons	Active Dry Yeast	2 teaspoons
-or-	-or-	-or-
1 teaspoon	Bread Machine/ Fast Rise Yeast	1½ teaspoons

FOLLOW THESE INSTRUCTIONS FOR THE FOLLOWING RECIPE

BREAD SELECT SETTING TO USE: Dough

1. Add lukewarm water to pan.
2. Add bread flour, dry milk, sugar and salt to pan. Tap pan to settle dry ingredients, then level ingredients, pushing some of the mixture into corners. Place butter into corners of pan.
3. Make a well in center of dry ingredients; add yeast. Lock pan into bread maker.
4. Program for DOUGH. Program TIME DELAY if being used. Start bread maker. When done, remove pan from bread maker. Place dough onto floured surface. Let rest 15 minutes.
5. Finish as desired, following shaping directions. Place on greased baking pans or sheets, cover and let rise in warm, draft-free place until double in size, about 45 minutes to 1 hour. Brush with butter or slightly beaten egg white and bake in preheated 350°F oven for 15 to 20 minutes or until golden brown. Serve warm.

BASIC DINNER ROLLS/BREAD STICKS [Ⓟ]

Makes between 2 and 3 dozen rolls depending on shape made.

INGREDIENTS

7½ ounces(¾cup+3Tbsp)	Water, 80-90°F
3 cups	Bread Flour
2 tablespoons	Dry Milk
3½ tablespoons	Sugar
1 teaspoon	Salt
3 tablespoons	Butter or Margarine
2 teaspoons	Active Dry Yeast
-or-	-or-
1½ teaspoons	Bread Machine/ Fast Rise Yeast
	Softened Butter or Slightly Beaten Egg White

FOR CRESCENT ROLLS:

Divide dough into 4 equal pieces. Roll each piece into a circle ¼-inch thick.

1. Cut each circle into 6 pie shaped wedges.
2. Roll each wedge from wide end to narrow tip.
3. Curve ends to form crescent.

Place on greased cookie sheets, about 1 inch apart. Cover and let rise until double in size. Makes 2 dozen.



FOR CLOVERLEAF ROLLS:

Divide dough into 54 equal sized pieces. Roll each piece into a ball.

1. Place 3 balls into a greased muffin cup.
2. Brush with softened butter.

Cover and let rise until double in size. Makes 1½ dozen.



FOR FOUR-LEAF CLOVER ROLLS:

Roll dough into a rectangle, ½-inch thick. Cut dough into 18 equal sized pieces.

1. Shape each piece into a ball. Place each ball into a greased muffin cup.
2. With scissors, snip each ball completely into quarters.
3. Brush with softened butter.

Cover and let rise until double in size. Makes 1½ dozen.



FOR BREAD STICKS:

Divide dough into 4 equal pieces. Divide each piece into 6 portions.

1. Roll each piece into a rope 8 inches long. Place onto greased cookie sheets, 1 inch apart.
2. Brush with egg white/water mixture and sprinkle with sesame seeds, poppy seeds, garlic salt, grated Parmesan cheese or other topping.

Cover and let rise until double in size. For drier bread sticks, reduce oven temperature to 300°F after 10 minutes of baking and bake 25 to 30 minutes longer. Makes 2 dozen.

FOLLOW THESE INSTRUCTIONS FOR THE RECIPE ON THIS PAGE

BREAD SELECT SETTING TO USE: Dough

1. Add warm milk and egg to pan.
2. Add bread flour, 3 tablespoons sugar and salt to pan. Tap pan to settle dry ingredients, then level ingredients, pushing some of the mixture into corners. Place butter into corners of pan.
3. Make a well in center of dry ingredients; add yeast. Lock pan into bread maker.
4. Program for DOUGH. Start bread maker. When done, remove pan from bread maker. Place dough on floured surface. Knead dough about 1 minute, then let rest 15 minutes.
5. Roll dough into a rectangle, about 15 x 10-inches. Spread 1/3 cup softened butter over dough to within 1 inch of edges. Then sprinkle 1/3 cup sugar, the cinnamon, nutmeg and chopped nuts evenly over dough. See Diagram 1. Roll dough up tightly on long side. Press edges to seal and form into a 12-inch long, evenly shaped roll. See Diagram 2. With a knife or 8-inch long piece of thread or dental floss, cut roll into 1-inch pieces. See Diagram 3. (If using thread or dental floss, slide under roll and criss cross ends to cut neatly through dough.) Place rolls into a greased 13 x 9-inch baking pan. See Diagram 4. Cover and let rise in warm, draft-free place until double in size, about 30 to 45 minutes.

Bake in preheated 375°F oven for 20 to 25 minutes or until golden brown. Cool in pan on rack for 10 to 15 minutes, then drizzle with powdered sugar icing made by combining 1 cup powdered sugar with 1 to 2 tablespoons milk and 1/2 teaspoon vanilla. Blend until smooth. If too thin or thick, add more powdered sugar or milk, respectively, until desired consistency is reached. Cut apart and remove from pan

CINNAMON ROLLS	
Makes 12 large rolls.	
INGREDIENTS	
6½ ounces(¾cup + 1 Tbsp.)	Milk, 80-90°F
1	Egg, large
3 cups	Bread Flour
3 tablespoons	Sugar
½ teaspoon	Salt
4 tablespoons	Butter or Margarine
2 teaspoons	Active Dry Yeast
-or-	-or-
1½ teaspoons	Bread Machine/ Fast Rise Yeast
FILLING:	
1/3 cup	Butter or Margarine, softened
1/3 cup	Sugar
2 teaspoons	Ground Cinnamon
1/2 teaspoon	Ground Nutmeg, optional
1/2 cup	Chopped Nuts

FOLLOW THESE INSTRUCTIONS FOR BOTH RECIPES ON THIS PAGE

Bread Select Setting To Use: Dough

1. Add lukewarm water and vegetable oil to pan.
2. Add flour, sugar and salt to pan. Tap pan to settle dry ingredients, then level ingredients, pushing some of the mixture into corners.
3. Make a well in center of dry ingredients; add yeast. Lock pan into bread maker.
4. Program for DOUGH. Program TIME DELAY if being used. Start bread maker. When done, remove pan from bread maker. Place dough onto floured surface. Knead about 1 minute, then let rest 15 minutes.
5. Roll dough out to fit 12 or 14-inch pizza pan. Place dough into greased pan which has been sprinkled with cornmeal. Press dough into pan, forming an edge. Let dough rise in warm, draft-free place for 20 to 25 minutes.
6. Spread pizza sauce evenly over crust, then top with favorite meat, toppings and shredded cheese. Bake in preheated 425°F oven for 20 to 25 minutes or until nicely browned on top. Let rest 5 minutes before cutting.

PIZZA DOUGH [Ⓟ]

Makes a 12 or 14-inch pizza. Recipe can be doubled to make 2 pizzas.

INGREDIENTS

6 ounces (¾ cup)	Water, 80-90°F
2 tablespoons	Vegetable Oil
2 cups	All purpose or Bread Flour
½ teaspoon	Sugar
½ teaspoon	Salt
2 teaspoons	Active Dry Yeast
-or-	-or-
1½ teaspoons	Bread Machine/Fast Rise Yeast
8 ounces	Pizza Sauce
	Favorite Meat, Toppings and Cheese

WHOLE WHEAT PIZZA DOUGH [Ⓟ]

Makes a 12 or 14-inch pizza. Recipe may be doubled to make 2 pizzas.

INGREDIENTS

6 ounces(¾ cup)	Water, 80-90°F
1 tablespoon	Vegetable Oil
2¼ cups	Whole Wheat Flour
½ teaspoon	Sugar
½ teaspoon	Salt
2 teaspoons	Active Dry Yeast
-or-	-or-
1½ teaspoons	Bread Machine/Fast Rise Yeast
8 ounces	Pizza Sauce
	Favorite Meat, Toppings and Cheese

90 DAY WARRANTY

Your West Bend® Warranty covers failures in the materials and workmanship of the Bread Maker for 90 days from the date of original purchase. Any failed part of the Bread Maker will be repaired or replaced without charge.

This warranty gives you specific legal rights and you may also have other rights, which vary from state to state. This warranty does not cover alleged damage caused by misuse, abuse, accidents or alterations to the Bread Maker.

If you think the Bread Maker has failed or requires service within its warranty period, you may call The West Bend Company (262) 334-6949, or if you choose, carefully package and return the Bread Maker prepaid and insured with a description of the difficulty:

The West Bend Company
Attn: Housewares Returned Goods
1100 Schmidt Road
West Bend, WI 53090-1961

Please ensure that you enclose the sales slip or proof of date of purchase in order to assure warranty coverage.

BONUS! RECIPE BOOK

A recipe book containing dozens of recipes developed exclusively for West Bend® Bread Makers is available. To order, write to the address above. Include \$8.95 **plus your area sales tax** with your request. **Payment must accompany order.** Make check or money order payable to The West Bend Company. Please allow 2 weeks for delivery. Price subject to change without notice.

REPLACEMENTS PARTS AVAILABLE

Replacement bread pans and knead bars may be ordered directly from The West Bend Company. To order, write to the address above. Be sure to include the catalog number of your Bread Maker(#410__), found on back of your machine, a description of what you want and the quantity. Along with this information please include your name, mailing address and your Visa, MasterCard, or Discover credit card number for the billing of the part(s) to you. Your state's sales tax and a handling fee will be added to your total charge. Or, to send a check or money order call 262-334-6949 to obtain purchase amount. Please allow 2 weeks for delivery.

Specifications:

120 V AC, 60Hz
Heater- 430 Watts
Motor- 145 Watts

This booklet contains important and helpful information on your new product. Please file it for handy reference to instructions for proper use and care, warranty and service information.

For your personal reference, attach dated sales receipt for warranty proof of purchase and record the following information:

Date purchased or received as a gift _____
Where purchased and price, if known _____

WEST BEND®

Free Manuals Download Website

<http://myh66.com>

<http://usermanuals.us>

<http://www.somanuals.com>

<http://www.4manuals.cc>

<http://www.manual-lib.com>

<http://www.404manual.com>

<http://www.luxmanual.com>

<http://aubethermostatmanual.com>

Golf course search by state

<http://golfingnear.com>

Email search by domain

<http://emailbydomain.com>

Auto manuals search

<http://auto.somanuals.com>

TV manuals search

<http://tv.somanuals.com>