

USER'S MANUAL

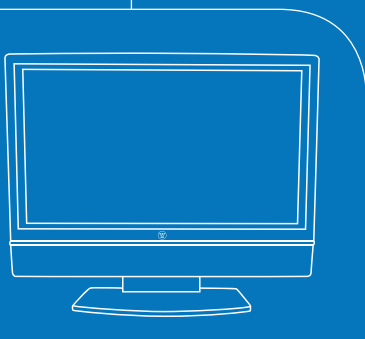

27" WIDESCREEN LCD MONITOR
Model LCM-27w4



Westinghouse

Contents

Product Safety Instructions	1
Safety Guidelines.....	2
Cleaning the LCD Monitor	3

INSTALLATION

Package Contents.....	4
Front View of the LCD Monitor.....	4
Side View of the LCD Monitor.....	5
Rear View of the LCD Monitor.....	6
Installation.....	7

OSD Functions

PICTURE PARAMETERS: Brightness / Contrast / Saturation / Hue / Color Temp / Sharpness / Aspect Ratio / Backlight / Reset.....	10
PC PARAMETERS: Auto Adjust / Clock / Phase / Position.....	11
AUDIO SETTINGS: Volume / Bass / Treble / Balance / Mute / Speaker / Reset.....	12
PICTURE-IN-PICTURE: Display Mode / Main Source / PIP Source / Swap / PIP Position / PIP Size / Audio From.....	13
GENERAL SETTINGS: Menu Position / Menu Timeout / Language / Transparency / DPMS / LED / System Info / Factory Reset.....	14
Specifications.....	15
Troubleshooting	16

PRODUCT SAFETY INSTRUCTIONS

Follow and obey all warnings and instructions marked on the LCD monitor. For your safety, please read all the safety and operating instructions before you operate the LCD monitor. Keep this user's manual for future reference.

Overloading

Do not overload wall outlets, extension cords, or power strips. This can result in fire or electronic shock.

Power Cord Protection

Power supply cords should be routed so that they are not likely to be walked on or pinched by items placed upon or against them. Periodically inspect the cords and each end of the cords for damage. The LCD monitor shall be installed near a wall socket outlet and the plug on power cord shall be readily accessible.

Ventilation

Slots and openings on the cabinet are provided for ventilation purposes. To ensure reliable operation of the LCD monitor and to protect it from overheating, these openings must not be blocked or covered.

- Do not block the openings by placing the LCD monitor on a bed, sofa, rug or other similar surface.
- Do not place the LCD monitor in a built-in installation such as a bookcase or rack unless proper ventilation is provided and the manufacturer's instruction have been adhered to.

Other Notices

- Avoid exposing the LCD monitor to direct sunlight or high temperatures.
- Avoid exposing the LCD monitor to moisture or high humidity.
- Do not attempt repairs yourself. Your warranty does not cover repairs or attempted repairs by anyone not authorized by Westinghouse Digital.
- If the LCD monitor will not be used for a long period of time, unplug the LCD monitor and remove the batteries from the remote control.

Precautions

- Avoid touching the screen. Skin oils are difficult to remove.
- Never remove the rear cover. The LCD monitor contains high-voltage parts. You may be seriously injured if you touch them.
- Avoid exposing the LCD monitor to direct sunlight or another heat source. Orient the LCD monitor away from direct sunlight to reduce glare.
- Always handle the LCD monitor with care when moving it.
- Place the LCD monitor in a well-ventilated area; don't place the LCD monitor in airtight compartments. Do not place anything on the LCD monitor that prevents heat dissipation.
- Ensure that the area around the LCD monitor is clean and free of moisture.
- Do not place heavy objects on the LCD monitor, audio/video cables, or power cord.
- If the LCD monitor emits smoke, abnormal noise, or a strange odor, immediately turn it off and contact the Westinghouse Service Center.
- **WARNING – To Reduce The Risk Of Fire Or Electric Shock, Do Not Expose The LCD monitor To Rain Or Moisture!** The LCD monitor shall not be exposed to dripping or splashing and objects filled with liquids, such as vases, shall not be placed on the Monitor.

Safety Guidelines

WARNING: This device must be operated with the original power supply.

CAUTION: The power supply outlet should be located near the LCD Display and should be easily accessible. Always use the appropriate AC cord that is certified for your specific country. Some examples are listed below:

- | | |
|-----------------|--|
| USA.....UL | Switzerland SEV |
| Canada.....CSA | Britain BASE/BS |
| Germany.....VDE | Japan Electric Appliance Control Act |

IMPORTANT NOTICE CONCERNING POWER CORD SELECTION

The specific power cord for this LCD Display is enclosed and has been selected according to the country of destination and must be used to prevent electric shock. Use the following guidelines if it is necessary to replace the original cord set, or if the cord set is not enclosed. The female receptacle of the cord set must meet IEC-60320 requirements and should look like Figure A1 below:



For the United States and Canada

In the United States and Canada the male plug is a NEMA5-15 style (Figure A2), UL Listed, and CSA Labeled. For LCD Display that are placed on a desk or table, type SVT or SJT cord sets may be used. For LCD Display placed directly on the floor, only SJT type cord sets may be used. The cord set must be selected according to the current rating for the LCD Display. Please consult the table below for the selection criteria for power cords used in the United States and Canada.

Cord Type	Size of Conductors in Cord	Maximum Current Rating of Unit
SJT	18 AWG	10 Amps
	16 AWG	12 Amps
	14 AWG	12 Amps
SVT	18 AWG	10 Amps
	17 AWG	12 Amps

FCC Compliance Statement

This equipment has been tested and complies with the limits for a Class B digital device, pursuant to part 15 of the FCC Rules. These limits are designed to provide reasonable protection against harmful interference in a residential installation. This equipment generates, uses, and can radiate radio frequency energy, and may cause harmful interference to radio communications if not installed and used in accordance with the instructions. However, there is no guarantee that interference will not occur in a particular installation. If this equipment does cause harmful interference to radio or television reception, which can be determined by turning the equipment off and on, the user is encouraged to try to correct the interference by one or more of the following measures:

- Reorient or relocate the receiving antenna.
- Increase the separation between the LCD Display and receiver.
- Connect the equipment into an outlet on a circuit different from that to which the receiver is connected.
- Consult the Westinghouse Service Center or an experienced radio/TV technician for assistance.

FCC Warning

To assure continued FCC compliance, the user must use a grounded power supply cord and the provided shielded video interface cable with bonded ferrite cores. If a BNC cable used, use only a shielded BNC (5) cable. Also, any unauthorized changes or modifications not expressly approved by Westinghouse Digital will void the user's authority to operate this device.

Cleaning the LCD Monitor

- **MAKE SURE THE LCD MONITOR IS TURNED OFF**
- **NEVER SPRAY OR POUR ANY LIQUID DIRECTLY ONTO THE SCREEN OR CASE**

To clean the screen:

1. Wipe the screen with a clean, soft, lint-free cloth. This removes dust and other particles.
2. If it still is not clean, apply a small amount of non-ammonia, non-alcohol based glass cleaner onto a clean, soft, lint-free cloth, and wipe the screen.

To clean the case:

1. Use a soft, dry cloth.
2. If it still is not clean, apply a small amount of non-ammonia, non-alcohol based, mild non-abrasive detergent onto a clean, soft, lint-free cloth, then wipe the surface.

Disclaimer

Westinghouse Digital does not recommend the use of any ammonia or alcohol-based cleaners on the LCD screen or case. Some chemical cleaners have been reported to damage the screen and/or case. Westinghouse Digital will not be liable for damage resulting from the use of any ammonia or alcohol-based cleaners.

INSTALLATION

Package Contents

Your product package includes:

- A 27" Westinghouse LCD Monitor
- AC Power Cord
- User's Manual
- D-SUB (VGA) Cable

Note: For information about purchasing a remote control unit for your LCD monitor, please log on to our website at www.westinghousedigital.com.



Front View of the LCD Monitor

Use the buttons on the right side of the LCD monitor to display the On Screen Display (OSD). The OSD controls are defined in "OSD Functions".

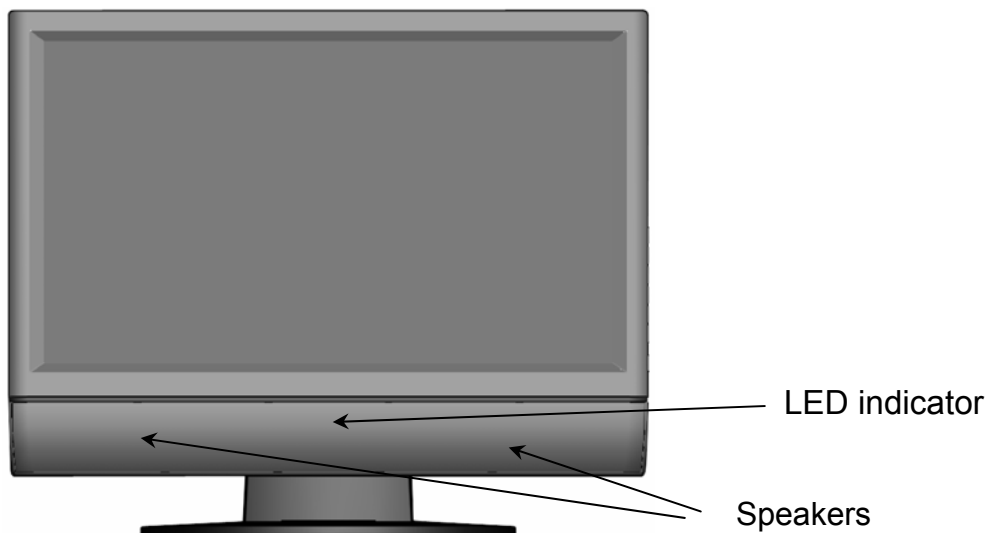

Side View of the LCD Monitor

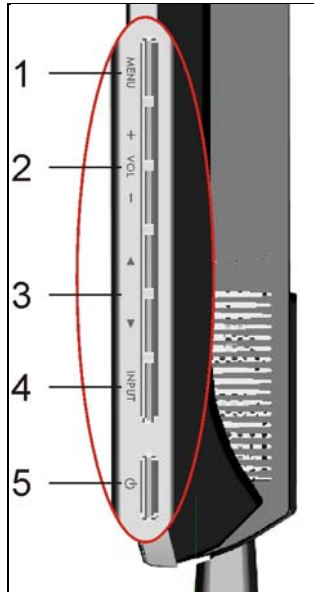
	1. Menu	Turn OSD Menu ON/OFF
	2. Volume + / -	Increase/Decrease sound volume or adjust a highlighted control while in the OSD Menu.
	3. OSD Selection ▲ / ▼	Highlight a control while in the OSD Menu.
	4. Input	Select Active source Input or choose a selection while in the OSD MENU.
	5. Power Button	Turn Power ON/OFF

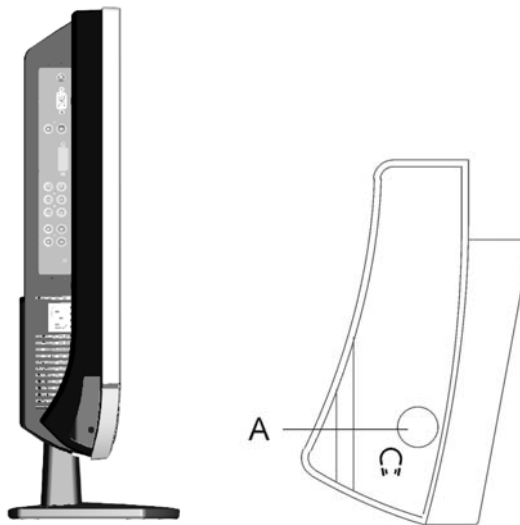

A. Headphone Jack.

Rear View of the LCD Monitor

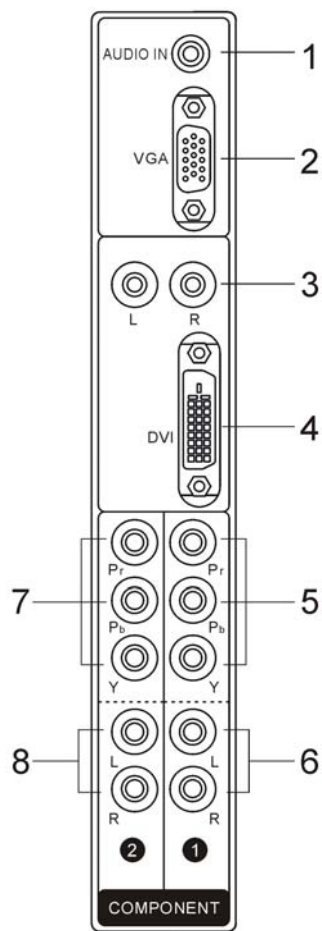
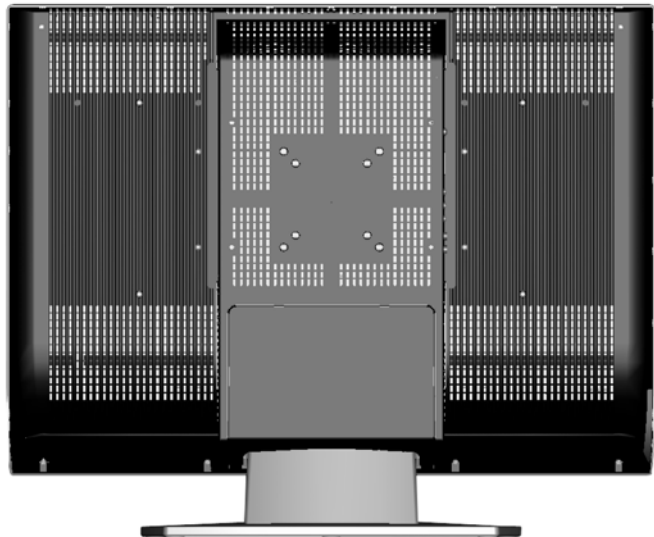

- 1. VGA Audio IN**
Connect to the Audio out (Green) from a computer or other device with a VGA output.
- 2. VGA**
Using the 15-pin VGA cable provided, connect to a computer or other device with a VGA output.
- 3. DVI Audio Input (Left / Right)**
Connect an external audio source to this jack.
- 4. DVI**
Using a 20-pin DVI cable, connect to a computer or other device with a DVI output.
- 5. YPbPr1 Input**
Connect an external video device with component output to these jacks.
- 6. YPbPr1 Audio 1 Input (Left / Right)**
Connect an external audio source to these jacks.
- 7. YPbPr2 Input**
Connect an external video device with component output to these jacks.
- 8. YPbPr2 Audio 2 Input (Left / Right)**
Connect an external audio source to these jacks.
- 9. AC IN (Power)**
Connect the power cord from AC IN to a power source.

Installation

IMPORTANT: Before beginning, make sure all devices are turned off.

1. Connect audio and video cables to a computer

Connect one or all of the following into the back of the LCD monitor:

VGA CONNECTION: Connect the enclosed analog VGA cable from your computer VGA OUT port to the LCD monitor VGA IN port.

DVI CONNECTION: Connect a Digital DVI cable from your computer or DVD DVI OUT port to the LCD monitor DVI-HDCP port.

AUDIO CONNECTION: Connect a stereo mini cable from your computer AUDIO OUT port to the AUDIO IN port on the LCD monitor.

COMPONENT CONNECTION: Connect YPbPr component cables from compatible devices to the back panel of the LCD monitor.

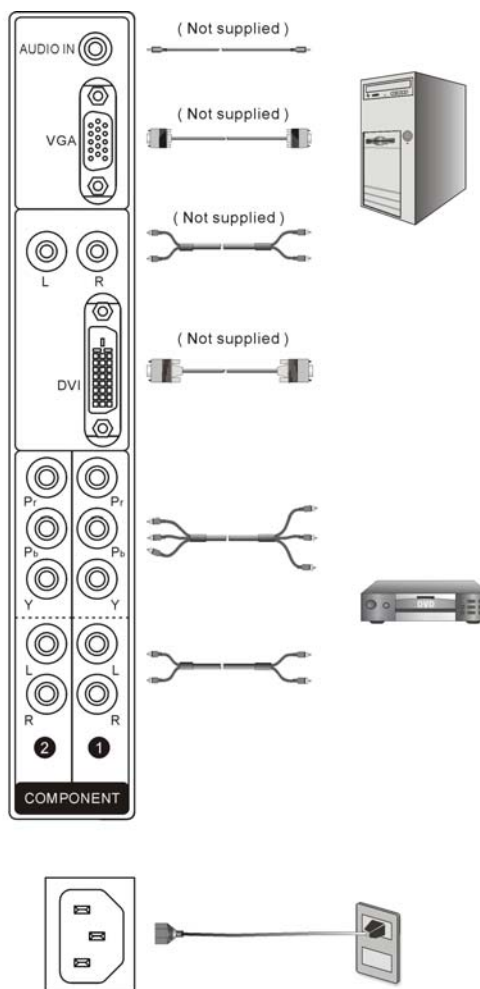

2. Connect the power cable

Connect the power cord to the LCD monitor then to a properly grounded AC outlet.

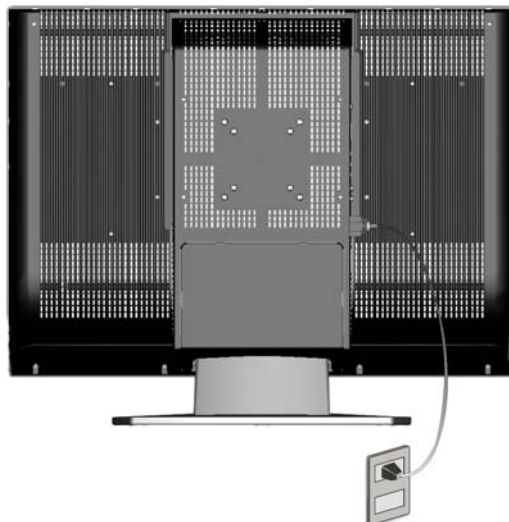

3. Turn the Power On

Press the Power ON button on the right side of the LCD monitor.



4. Select the input source for the LCD monitor using the OSD menu

5. If connecting to a computer (VGA/DVI):

For the best picture quality, set the timing mode of your computer to 1280 x 720 at 75Hz. Refer to the graphic card's user guide of your computer to set this timing mode.

OSD Function

All the OSD function settings are controlled using the control keys on the right side of LCD monitor.

To display the OSD main menu, press the MENU key on the right side of front control keys of the LCD monitor. Use the ▲/▼ keys to highlight the desired OSD sub-menu.



Main Menu

To select a sub-menu, press the INPUT key on the right side of the LCD monitor. Then use the “+” and “-” keys to adjust the selected OSD sub-menu.



PICTURE PARAMETERS:



Function Name	Function
Brightness	Brightness adjustment
Contrast	Contrast adjustment
Saturation	Saturation adjustment
Hue	Hue adjustment
Color Temp	Color temperature adjustment (Color 1, Color 2, Color 3)
Sharpness	Sharpness adjustment (Sharpness cannot be adjusted in PC mode)
Aspect Ratio	Set Display to "STANDARD" / "FILL" / "ZOOM"
Backlight	Backlight adjustment
Reset	Reset video settings

PC PARAMETERS:

NOTE: The PC PARAMETERS menu is only available when the VGA source is selected.



Function Name	Function
Auto	Automatically adjust the horizontal phase of the image
Clock	Clock adjustment
Phase	Phase adjustment
Position	Adjust the horizontal and vertical position of the image

AUDIO SETTINGS:



Function Name	Function
Volume	Volume adjustment
Bass	Bass adjustment
Treble	Treble adjustment
Balance	Balance adjustment
Mute	Select Audio OFF or ON
Reset	Reset audio settings

PICTURE-IN-PICTURE:

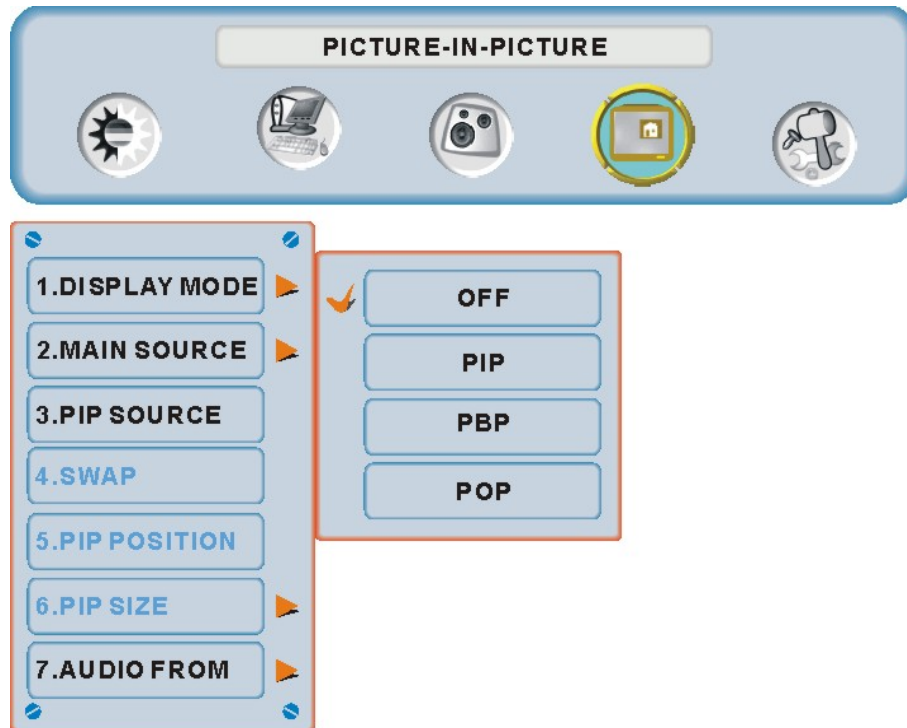

Function Name	Function
Display Mode	OFF --> PIP --> PBP --> POP
Main Source	Select main screen sources VGA --> DVI--> YPbPr1 --> YPbPr2
PIP Source	Select sub screen sources Please see PIP/PBP/POP specification in Table 1
Swap	Swap main screen and sub-screen source
PIP Position	Sub-screen display horizontal/vertical position adjustment
PIP Size	Sub-screen display size adjustment (Small -->Medium --> Large)
Audio From	Select main screen or sub-screen audio sources

Table 1:

Main \ Sub	VGA	DVI	YPbPr1	YPbPr2
VGA	X	O	X	X
DVI	O	X	O	O
YPbPr1	X	O	X	X

X : Unavailable
O : Available

GENERAL SETTINGS:



Function Name	Function
Menu Position	OSD horizontal/vertical position adjustment
Menu Timeout	Set the time to turn off the OSD automatically
Language	Set the OSD language
Transparency	Set OSD transparency level
DPMS	Turn DPMS On or Off
LED	Turn the LED ON or OFF
System Info	Display Input source, type and signal
Factory Reset	Restore factory default settings

Specifications

Model Name		LCM-27w4	
Panel	Type	27" (26.97" viewable diagonal area), TFT (Thin Film Transistor), Active Matrix WXGA LCD, 1280 x 720 vertical stripe	
	Color	Anti-reflective coating + Anti-glare coating	
Viewing Angles		170° (H) / 170° (V)	
Input Signal	Video/Audio	VGA Analog * 1 (75 ohms, 0.7 Vp-p)/Mini-Stereo *1	
		H/V separated (TTL) for PC	
		DVI-D * 1 (HDCP support) / RCA (L/R) * 1	
		fh: 30-80 kHz, fv: 50-75 Hz	
		Component Video * 2 / RCA (L/R) Stereo * 2	
HDTV Compatibility		480i, 480P, 720P, 1080i	
PC Compatible	Recommended	1280 x 720 @ 75Hz	
	Supported	1280 x 1024 @ 60, 75Hz	800 x 600 @ 60, 75Hz
		1280 x 768 @ 60 Hz	720 x 400 @ 70 Hz
		1024 x 768 @ 60, 75 Hz	640 x 480 @ 60, 75Hz
		832 x 624 @ 75Hz	
Speaker Output		9w (x 2 Channels)	
Power	Voltage	100-240 VAC, 50/60 Hz (auto switch), 1.6A, universal.	
Temperature (Note A)	Operating	0° to +35° C (Hum.<90%)	
	Storage	-20° to +60° C (Hum.< 35%)	
Humidity (Relative) (Note A)	Operating	20 to 90% non-condensing (Ta< 35%)	
	Storage	10 to 90% non-condensing. (Note A)	
	Wet-bulb temperature should be 39° C Max. (Ta> 40°C)		
<i>Note: The temperature and relative humidity range is shown in right side</i>			
Altitude	Operating	0 to 3,000 m	
	Storage	0 to 12,000m	
Dimensions	Physical	26.6" (W) x 21.9" (H) x 7.3" (D)	
Weight	Net / Gross	28.7 lbs / 35.3 lbs	
Regulations		UL/C-UL, FCC-B	
Power saving	On	<150w (Blue LED)	
Modes	Active Off	<3w	

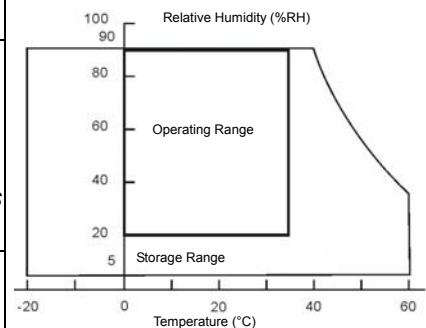

Preset Timing Mode: Pre-adjusted to reduce blanking - 1280 x 720 at 75Hz
Warning: Do not set the graphics card in your computer to exceed these refresh rates; by doing so may result in permanent damage to the LCD monitor.

Note A: Product specifications are subject to change without notice.

Troubleshooting

No Power

- Make sure power button is ON (Blue LED).
- Make sure AC power cord is securely connected to the AC socket.
- Plug another electrical device (such as a radio) to the power outlet to verify that the outlet is supplying the proper voltage.

Power is ON but No Screen Image

- Make sure the video cable connected to the LCD monitor is tightly secured to the video output port on the back of the computer. If the other end of the video cable is not attached properly to the LCD monitor, secure it tightly.
- Adjust brightness and contrast.
- If you are using a Macintosh computer older than G3, you need a Macintosh adapter.
- Check Source settings.

Wrong or Abnormal Colors

- If any colors (red, green, or blue) are missing, check the component video cable to make sure it is connected securely. Loose or broken pins in the cable connector could cause an improper connection.
- Connect the LCD monitor to another computer.

No Sound

- Check the audio connection.
- Check the audio settings (e.g. Mute on or volume level is set to zero).
- Make sure that headphones are not connected to the Headphone Jack on the LCD monitor.

How Can I Find More Help?

- Log on to: www.westinghousedigital.com
- Contact Westinghouse Customer Service at (866) 287-5555 or write us at service@westinghousedigital.com



Westinghouse Digital Electronics
Santa Fe Springs, CA

www.westinghousedigital.com

SE-UM-2702-0501

Free Manuals Download Website

<http://myh66.com>

<http://usermanuals.us>

<http://www.somanuals.com>

<http://www.4manuals.cc>

<http://www.manual-lib.com>

<http://www.404manual.com>

<http://www.luxmanual.com>

<http://aubethermostatmanual.com>

Golf course search by state

<http://golfingnear.com>

Email search by domain

<http://emailbydomain.com>

Auto manuals search

<http://auto.somanuals.com>

TV manuals search

<http://tv.somanuals.com>