



Westinghouse Digital 2004

27" Wide-Format

LCD-TV

User's Manual

© 2003 Westinghouse Digital Electronics. All rights reserved.

 Westinghouse and You can be sure...if it's Westinghouse are trademarks of Westinghouse Electric Corporation and are used under license.



Preface

This manual is designed to assist you in setting up and using your LCD-TV. Information in this document has been carefully checked for accuracy; however, no guarantee is given to the correctness of the contents. The information in this document is subject to change without notice. This document contains proprietary information protected by copyright. All rights are reserved. No part of this manual may be reproduced by any mechanical, electronic or other means, in any form, without prior written permission of Westinghouse Digital Electronics.

Read and follow the **Important Safety Instructions** and **FCC Statement** located in the Appendix.

© Copyright 2003, 2004 Westinghouse Digital Electronics

Viacom Inc. owns the Westinghouse brand.

All Rights Reserved.

Revised October 20, 2004



Table of Contents

Introduction	3
Features	3
Installation Guide	4
Unpacking	4
Connections	5
Planning Your Connections	6
Antenna Connection	7
Video Connections	7
PC & Audio Output Connections	8
Power Connection	10
Using The Remote	10
Programming TV Channels	11
Enjoying Wide-Format Movies	11
Reference Guide	13
Connector Descriptions	13
Push-Button Control Descriptions	15
Remote Control Description	16
Picture-in-Picture Description	20
Display Menu	21
Display	23
TV	24
Geometric	25
Audio	26
Miscellaneous	27
Appendices	28
Trouble-Shooting	28
Specifications	30
Wall Mounting	32
Important Safety Instructions	33
FCC Statement	35



Introduction

Thank you and congratulations!

This user guide is divided into two parts: an Installation Guide and a Reference Guide. The first time you setup and use this LCD-TV, please follow the instructions in the Installation Guide. To fully explore the abilities and individual features of this LCD-TV, a Reference Guide follows this Installation Guide.

Features

This LCD-TV is HD-ready and requires an external HD source device that is not included with this product.

- Features (typical):
 - Cable-ready 181 channel NTSC TV tuner
 - Built-in progressive scan de-interlacing
 - 720p, 1080i, 480p, 480i, VGA and SVGA compatible
 - PIP, a variety of picture-in-picture and multiple picture arrangements
 - Stereo speakers (8W/channel)
 - Wireless remote control with direct source buttons
 - Thin timeless style, optional wall mount.
- Connectors (typical):
 - VGA inputs
 - 2 component Video: YPbPr(HD) inputs
 - S-Video, Video and RF NTSC inputs
 - 5 separate stereo audio inputs: 4+1 (AV+PC)
 - 1 audio output for external 5.1 surround sound processor
 - 1 subwoofer output for 2.1 sound
- Performance (typical):
 - Best progressive HD (1280x720) native resolution.
 - Wide 170 degree viewing angle
 - Bright 500nit display
 - High 500:1 contrast
 - Fast 16ms response time
 - Outstanding 75% NTSC color gamut



Installation Guide

You will soon be enjoying your LCD-TV. The following are instructions on what parts to expect to find within the box, how to connect your LCD-TV and how to use your remote to setup and configure basic options.

Unpacking

Carefully remove the LCD-TV and other contents from the box. Place the LCD-TV in a safe upright position with easy access to the connectors located on the rear of the display.

Please confirm the following list of items is included:

- LCD-TV
- Remote control
- 2 AAA batteries
- AC Power cord
- VGA cable (analog RGB).
- AV cable. (The Yellow connector is for video, the white connector is for left audio channel and the red connector is for the right audio channel.)
- Documentation

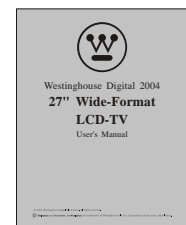
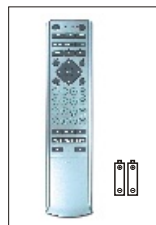



Connections

There are 4 separate locations for connectors on the rear of the LCD-TV: Antenna, Video, PC and Power.

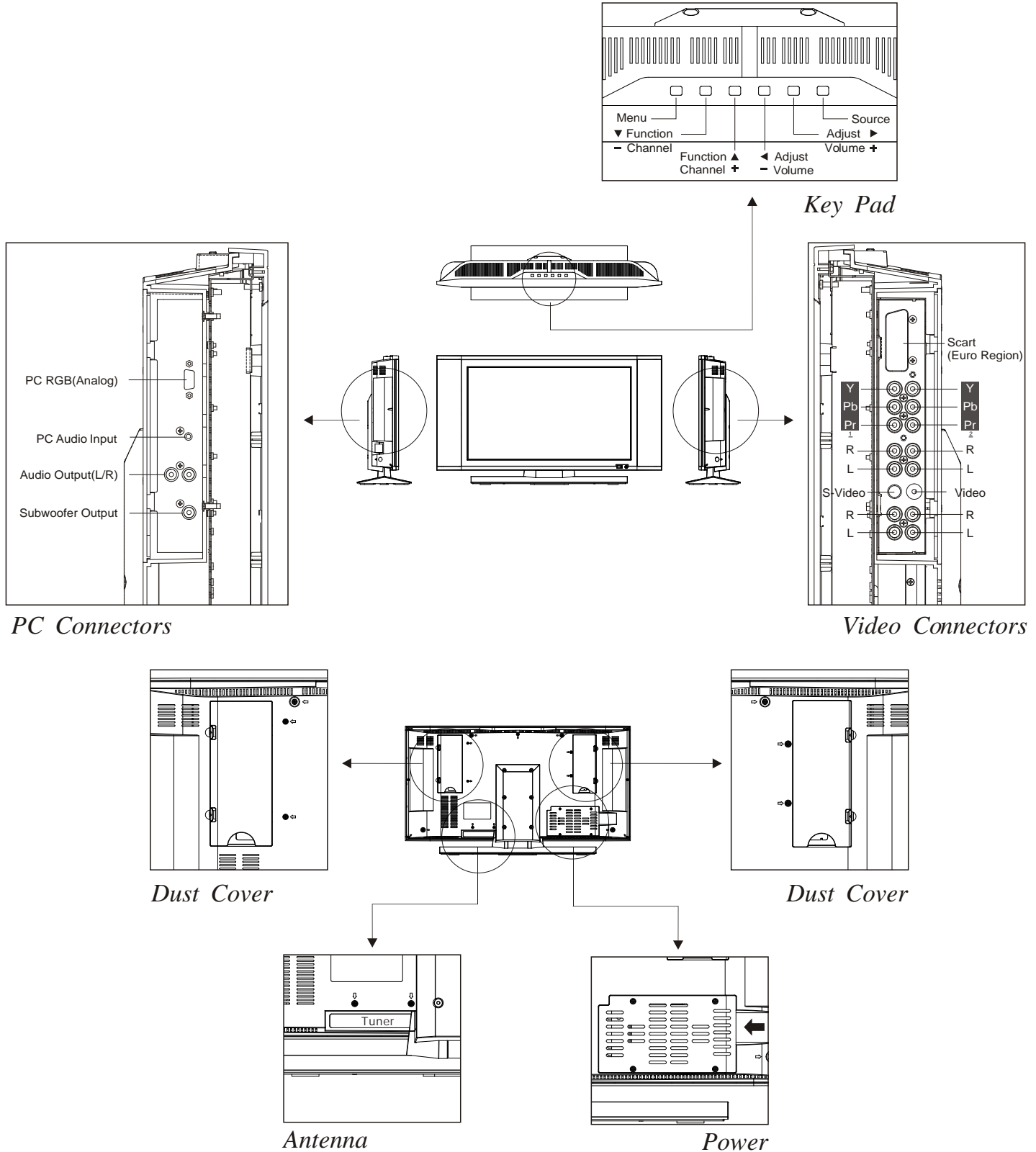



There are two user accessible covers that can be removed (without tools) by gently squeezing the plastic clip. Carefully remove both covers to expose the PC and AV connections. Replace these covers as desired.

Planning Your Connections

Below is a table of some common configurations that may help you to determine how best to connect your particular devices.

LCD-TV	Good	Better	Best	Your devices
VGA in		HD Cable or Satellite Receiver	PC	
YPbPr1 in		Progressive DVD	HD Cable or Satellite Receiver	
YPbPr2 in	DVD	Game console	DVD Recorder	
S-Video in	Cable or Satellite		Game console	
Video in	Game console	VCR		
Tuner in	VCR	Antenna	Antenna	
Audio Out			Surround Sound	
Subwoofer Out		Subwoofer		



To share an input or reduce the number of wires to the display, use a VCR or AV Receiver to consolidate connections. It is common to route the output of your camcorder, cable box (STB), satellite receiver (IRD) and personal video recorder (PVR) through your VCR for recording, editing and time shifting.

Not all devices are the same and many may need additional cables, adapters and setup. In particular, computers, game consoles, high-definition receivers and progressive DVD players must be set to 16:9 output accordingly.

Antenna Connection

This LCD-TV has a built-in cable-ready NTSC tuner for analog cable and NTSC broadcast signals. You may choose to connect the analog cable or TV antenna wire (not included) directly to this LCD-TV antenna input.

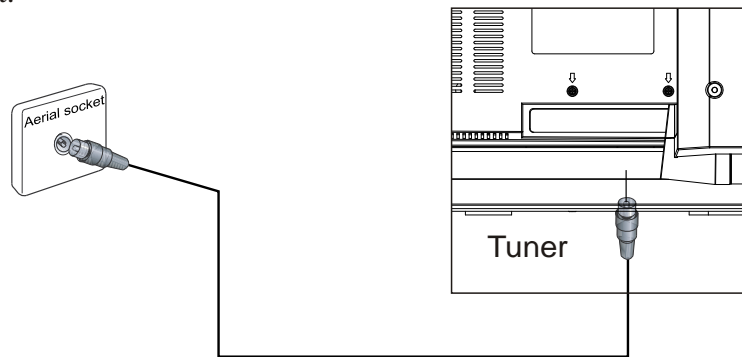

Video Connections

There are four types of video inputs: YPbPr1, YPbPr2, S-Video and Video. Each of these video inputs has a corresponding set of stereo left and right audio inputs.

These connectors are color-coded to match the colors of the corresponding connectors on other devices and cables.

The YPbPr1 and YPbPr2 inputs will only accept 480i, 480p, 1080i and 720p signals. Use this to connect high definition devices such as a terrestrial HDTV receiver, HD satellite box, HD cable box or progressive scan DVD player.

Use this to obtain better color performance from devices such as a DVD player. The built-in **progressive** scan logic will automatically convert interlaced DVD to non-interlaced.

The S-Video and Video inputs are provided for use with devices such as a VCR, satellite receiver, digital cable box, or game console. The built-in **progressive** scan logic will also automatically convert these interlaced NTSC signals to non-interlaced.

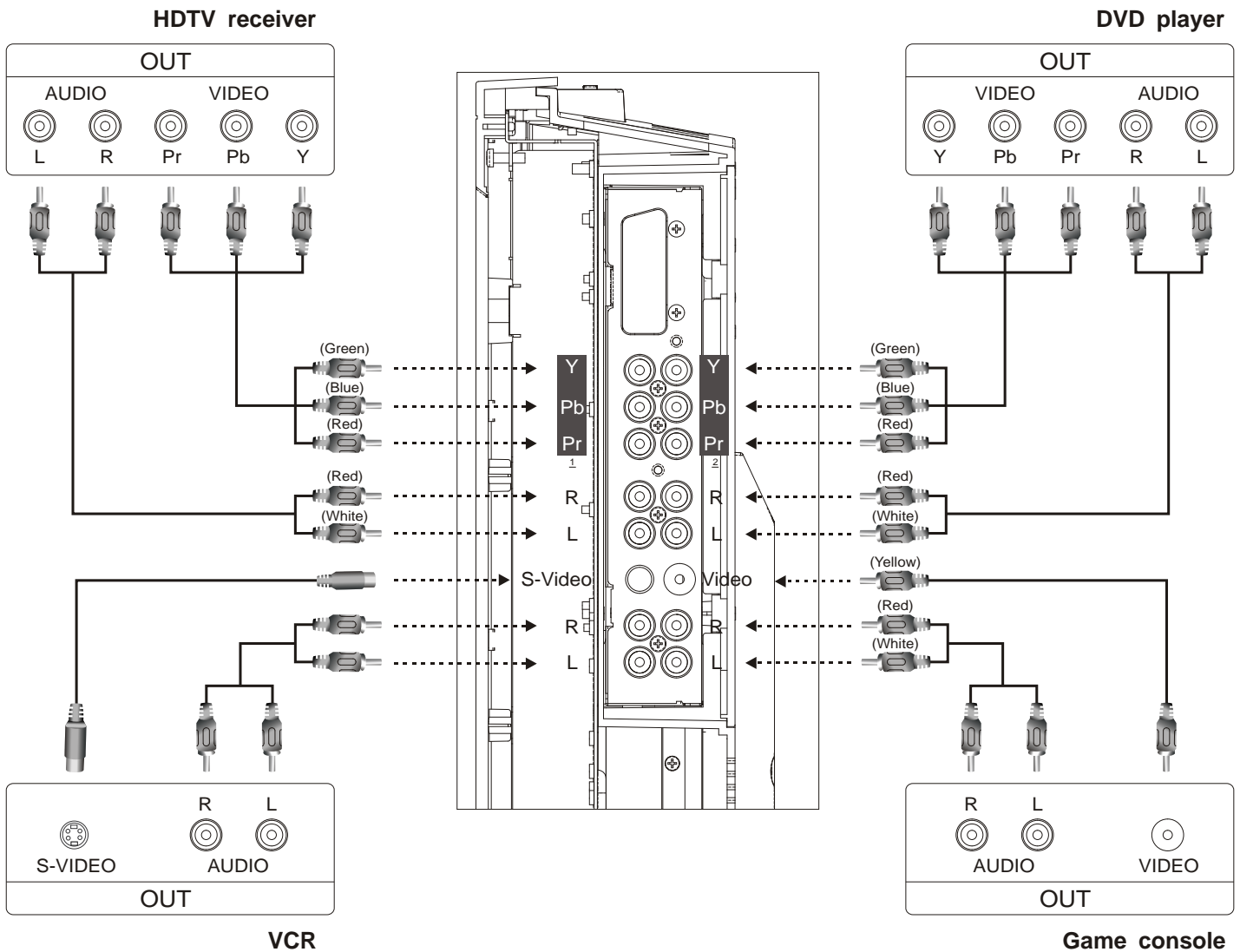

PC & Audio Output Connections

There are two PC inputs: VGA and PC audio. There is also an audio output and a subwoofer output. The VGA input is an analog RGB interface with separate H & V sync signals. VGA is more commonly found on computers. Attach the LCD-TV to your computer using the included (blue color-coded) VGA cable. The PC audio cable is not included and must be purchased separately.

For the VGA inputs, please remember to **adjust your computer resolution to match the 1280x720 resolution of the 27" LCD-TV for best performance. An additional software driver may be required from your PC graphics chip vendor to obtain wide format resolution support.**



The audio output is commonly used to connect to an external audio amplifier or surround sound processor.

The subwoofer output is used to attach an external powered subwoofer.

Remember to enable this feature from the Audio Menu of the LCD-TV. When the subwoofer software command is set to On, an internal crossover cuts off the low frequency signal to the built-in speakers. When the subwoofer software command is set to Off, the built-in speakers will output full range audio.

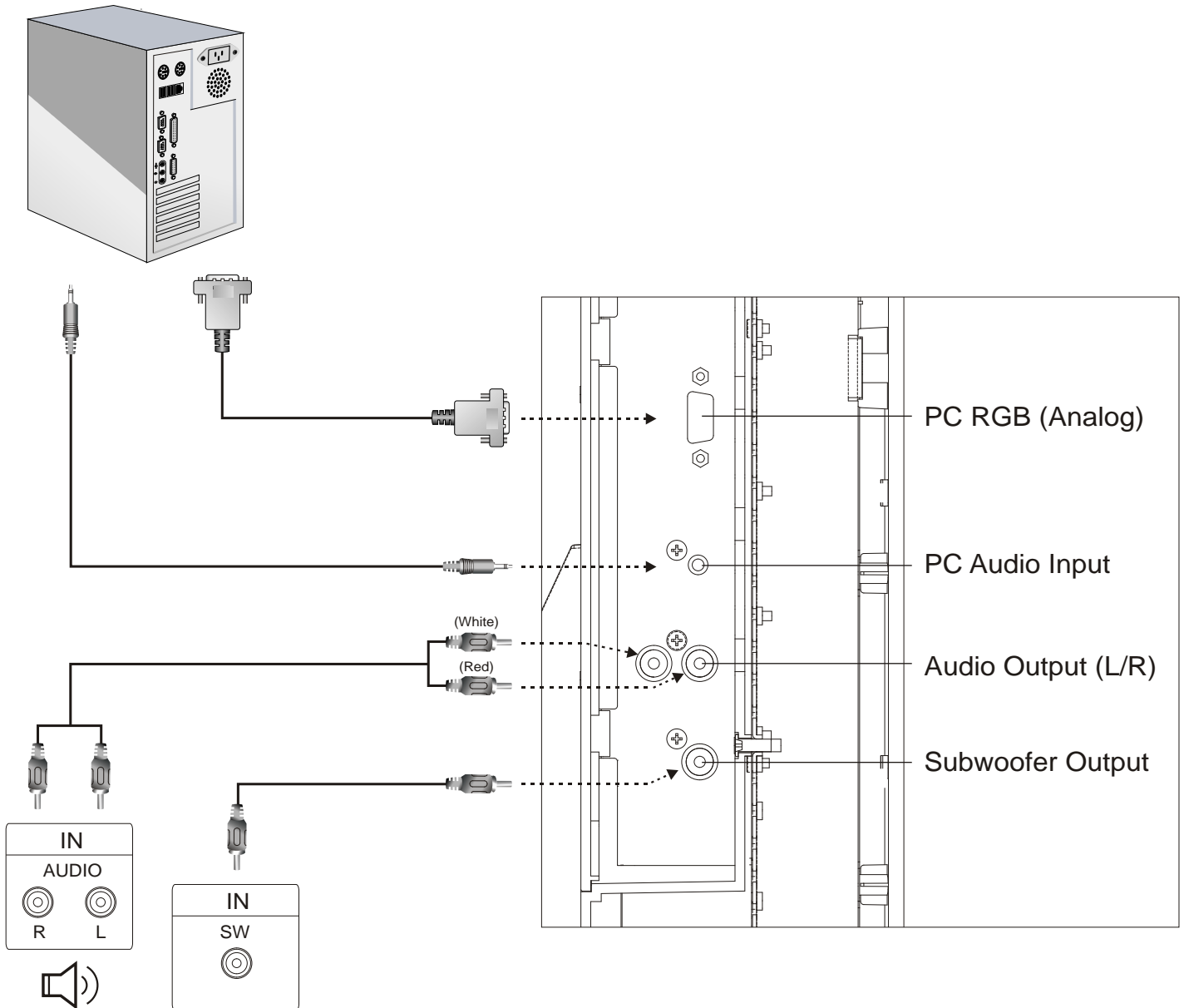

* Connection jack for subwoofer with built-in amplifier.

Power Connection

Attach the AC power cord to the LCD-TV and plug into an appropriate wall outlet.

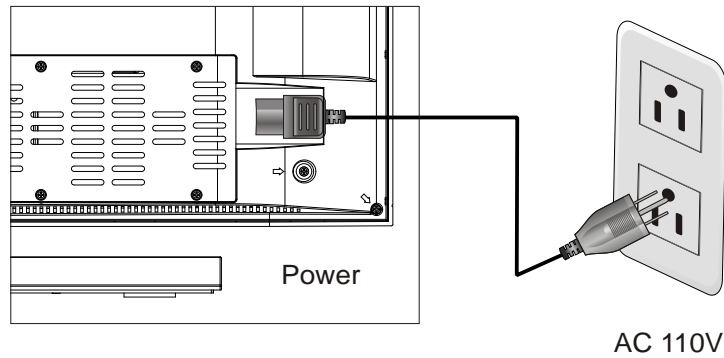

Using The Remote

Slide open the rear cover on the battery compartment and insert a fresh set of two AAA batteries. Replace the battery cover on the remote.

Turn on the TV by pressing the POWER button.

Adjust the volume using the volume up and down buttons, VOL+ and VOL-.

Select a video source in two ways. You may select a source directly using one of the buttons at the bottom of your remote control: TV, S-VIDEO, AV, YPbPr1, YPbPr2 and PC. Or you may scroll through a list of video sources using the SOURCE button located on top of the LCD-TV.

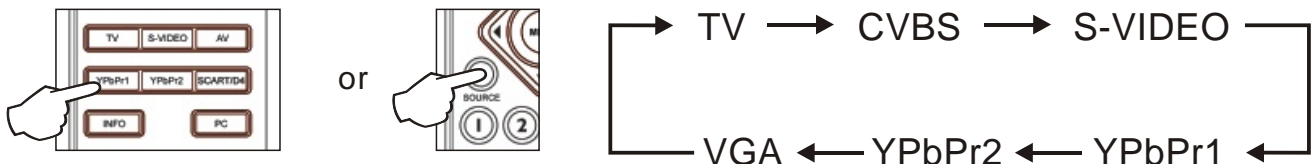



Programming TV Channels

Press the MENU button at the center of the remote. The command to automatically scan for program channels is located in the TV menu and labeled CH-SCAN.

You can now watch TV. Change channels by pressing the channel up and down buttons CH▲ and CH▼.

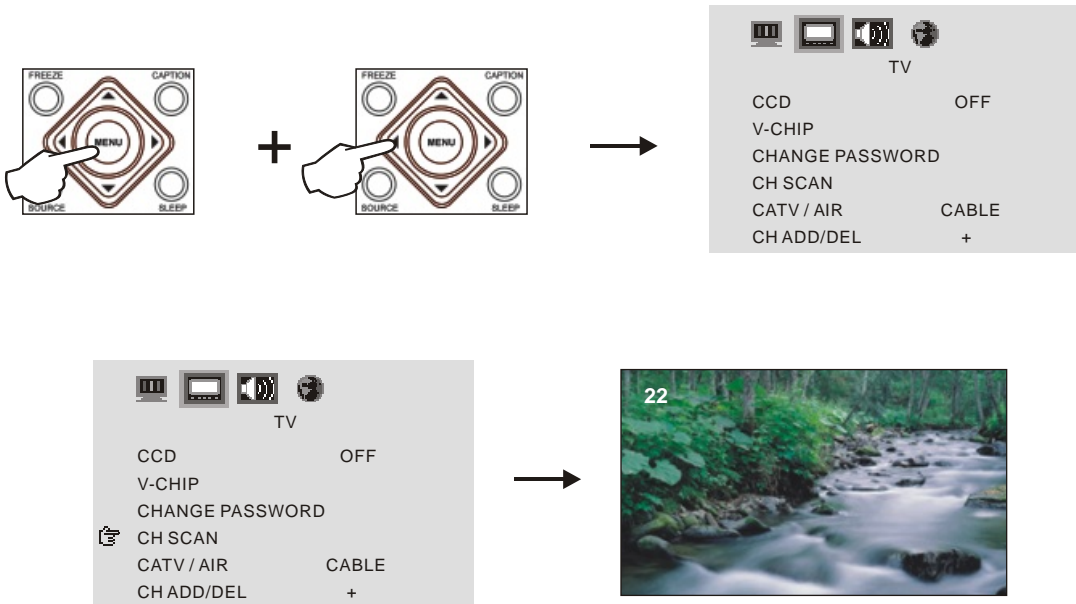

Enjoying Wide-Format Movies

As NTSC transitions to HDTV, you may experience a variety of content presented in different aspect ratios. This LCD-TV can scale the incoming video while maintaining the original aspect ratio or stretch the video to use the entire screen.

Use the SCALING button on the remote control to switch the aspect ratio as indicated here:

Use **FILL ALL** to stretch programs to occupy more of the screen. Use **FILL ALL** to view wide format (anamorphic) DVD movies. In particular, look for DVD movies that are labeled: "**Anamorphic Widescreen**" or "**Enhanced for 16:9 TV**" to obtain better performance.

Use **4:3 MODE** to maintain the correct original aspect ratio for most videotape, broadcast television, cable, satellite, HDTV and PC content. The unused portions on the left and right or top and bottom edges of the screen will appear black.



Note: Plasma users are often advised to use FILL ALL to stretch all content to the edges of the screen in order to reduce burn-in. This LCD-TV has no such problem with burn-in.

Use **PANORAMIC** to expand NORMAL 4:3 aspect ratio content horizontally using a creative non-linear formula. Objects in the middle maintain the original aspect ratio and only the two sides are expanded. Experiment with these **SCALING** settings to determine your personal preferences.

Use **WIDE** to expand letterbox content to occupy more of the screen. Occasionally, you may find a TV program or older DVD movie that is actually presented as letterbox format within an NTSC signal. Use this mode to zoom the image up to full screen. The unused portions on the top and bottom of the screen will appear black.

Note: In **WIDE** mode, non-letterbox content will enlarge beyond the boundaries of the screen. Some portions of the video will not be visible above and below the screen. This may include OSD information from you DVD player, cable decoder or satellite receiver. To see the entire screen, switch to a different **SCALING** mode.

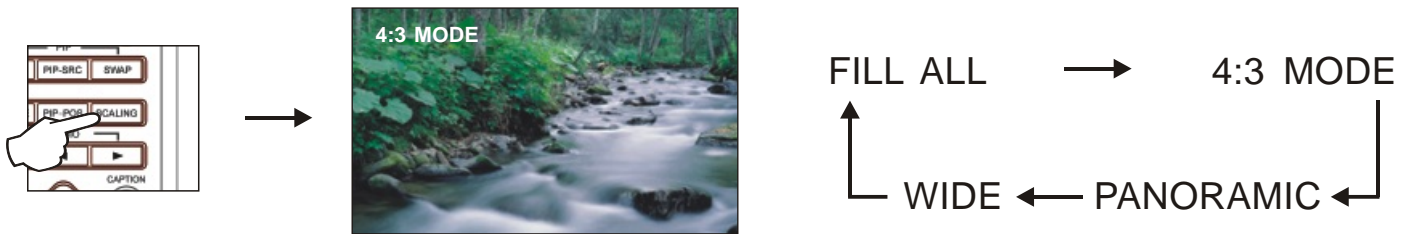



Reference Guide

Use this section of the user manual to learn about individual features and functions of this LCD-TV. Learn the purpose of each connector on the back panel. Learn to use each control button on the LCD-TV and remote control. Learn how to use the software features that appear in a menu displayed on-screen.

Connector Descriptions

There are 4 sets of color-coded connectors on the rear of the LCD-TV: Power; PC inputs and audio outputs; video inputs; and antenna input.



Antenna input Connector	Color Code	Description
Tuner Input	Silver	75ohm coaxial cable with F-type connector. Attach your TV antenna or analog cable service here.



PC inputs & audio output Connectors	Color Code	Description
PC RGB (analog)	Blue	Use the included VGA cable to use this LCD-TV as a personal computer monitor.
PC Audio Input	Green	Use this miniature stereo input to attach to your computer audio output.
Audio Output	White, Red	Use these 2 RCA jacks to provide audio to an external amplifier or surround sound decoder.
Subwoofer Output	White, Red	Use these 2 RCA jacks to provide audio to an external powered subwoofer.



Video Connectors	Color Code	Description
YPbPr1 Input Y Pb Pr Right audio Left audio	Green Blue Red Red White	5 RCA jacks. Use this set of component video connectors to attach a high-definition HDTV receiver that can output 480p, 1080i or 720p format. May also be used to attach a progressive scan DVD player.
YPbPr2 Input Y Pb Pr Right audio Left audio	Green Blue Red Red White	5 RCA jacks. Use this set of component video connectors to attach a high-definition HDTV receiver that can output 480p, 1080i or 720p format. May also be used to attach a progressive scan DVD player.
S-Video Input Right audio Left audio	Black Red White	1 DIN, 2 RCA jacks. S-Video is superior to Composite Video but not as good as YPbPr or RGB video.
Video Input Right audio Left audio	Yellow Red White	3 RCA jacks. Use the included composite video cable to attach a popular device such as a VCR or game console.



Power Connector	Color Code	Description
Power Input	Black	Use the included power cord to attach to an appropriate AC wall outlet. 100-240VAC, 50-60Hz, 1.8A



Push-Button Control Descriptions

The power button is located separately on the front lower right of the display.



Button	Description
POWER	<p>Use this button to switch the LCD-TV between on and standby modes.</p> <p>The power indicator will glow green when the power is on.</p> <p>The power indicator will glow red when the LCD-TV is in standby.</p> <p>The power indicator will not glow if the power cord is unplugged.</p>

The MENU, CHANNEL, VOLUME and SOURCE buttons are conveniently located on the top of the LCD-TV.





Remote Control Description

The remote control uses 2 AAA (1.5VDC) batteries. The buttons are grouped in 4 categories:

- Power & Mute Buttons
- Picture-in-Picture Buttons
- Audio & Video Adjustment Buttons
- Volume & Channel Control Buttons

The index number corresponds to the callout number for each button depicted in the illustration.

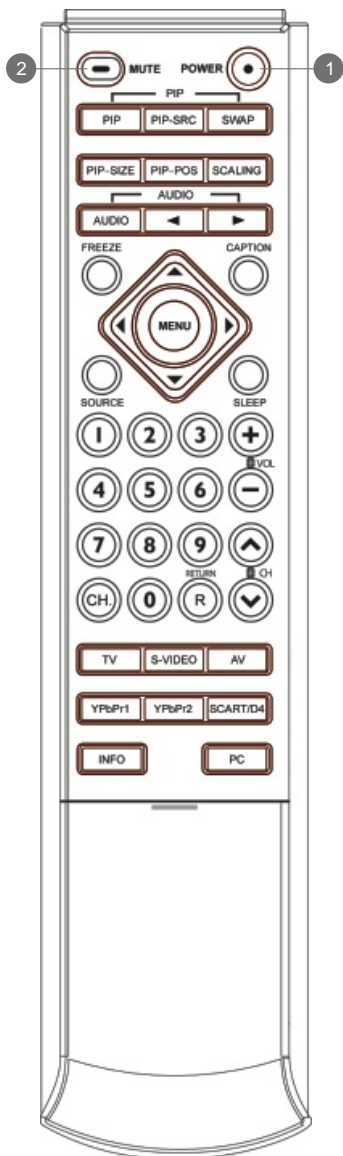

Index	Power & Mute Buttons	Description
1	POWER	Use this button to switch the LCD-TV between on and standby modes. The power indicator will glow green when the power is on. The power indicator will glow red when the LCD-TV is in standby. The power indicator will not glow if the power cord is unplugged.
2	MUTE	Use this button to toggle audio on and off.

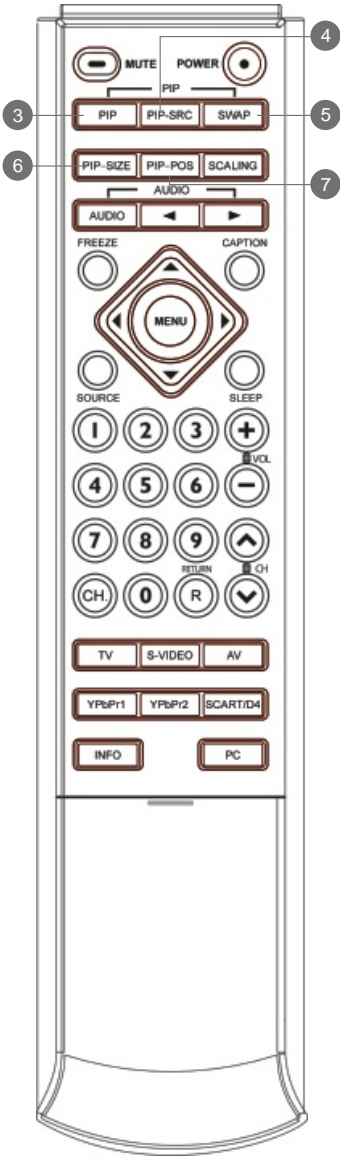

Index	Picture-in-Picture Buttons	Description
3	PIP	Use this button to activate and adjust Picture-in-Picture features in conjunction with SOURCE, SWAP, PIP-SIZE and PIP-POS. (See also Picture-in-Picture Description.)
4	PIP-SRC	Use this button to change the small picture's signal source.
5	SWAP	Use this to exchange the two PIP video sources.
6	PIP-SIZE	Use this to change the size of the small video window.
7	PIP-POS	Use this to move the position of the small video window.

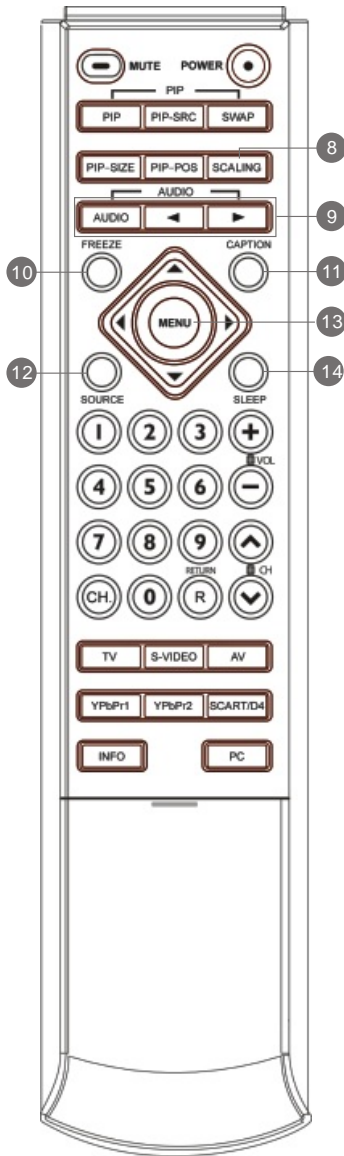

Index	Audio & Video Adjustment Buttons	Description
8	SCALING	Use this button to adjust aspect ratio and to fill the screen. Use FILL ALL for HD content. Use 4:3 MODE for 4:3 content. Use PANARAMIC to stretch 4:3 content to full screen. Use WIDE for letterboxed content.
9	AUDIO ◀ ▶	Use this button with the two arrow buttons to select among stereo, mono and the secondary audio program (SAP).
10	FREEZE	Use this button to hold a particular image on screen. This may be useful in making fine color adjustments.
11	CAPTION	Use this button to turn on and off closed caption display.
12	SOURCE	Use this button to scroll through the video input sources: TV, AV, S-VIDEO, YPbPr1, YPbPr2, and VGA.
13	MENU ▲ ▼ ◀ ▶	Use the MENU button and 4 arrow keys to traverse and adjust the software features. Press the MENU button again to exit.
14	SLEEP	The SLEEP feature is used to automatically shut off this LCD-TV after a preset period of time has passed. Press the SLEEP button repeatedly to select 0, 30, 60, 90 or 120 minutes. Selecting 0 turns the SLEEP feature off.

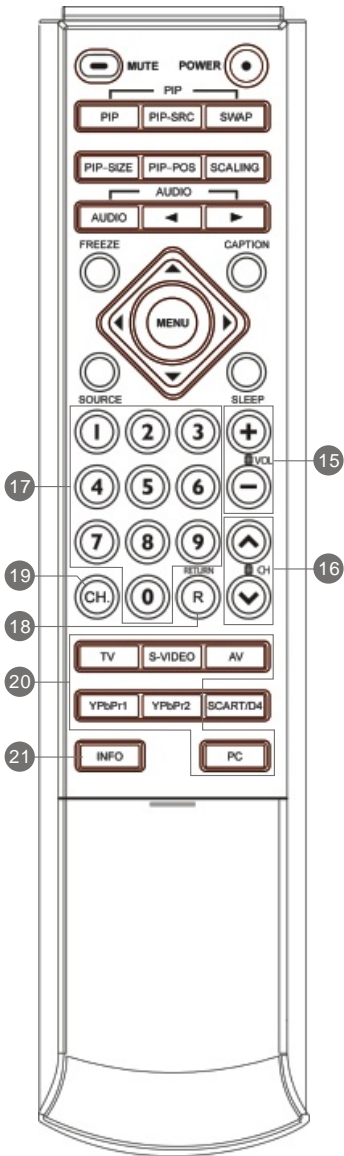

Index	Volume & Channel Control Buttons	Description
15	VOL+-	Use VOL+ and VOL- keys to adjust the audio louder and quieter.
16	CH ^ v	Use the CH ^ and CH v keys to surf forwards and backwards between pre-programmed TV channels.
17	0-9	Press 0-9 to select channels from 01 to 125. If you want to select the channel 123, you just press the "1", "2", "3" buttons in proper order.
18	R (RETURN)	Use the R button to return to the previous channel.
19	CH	Use the CH button to display the current channel information on the LCD-TV screen.
20	TV, S-VIDEO, AV, YPbPr1, YPbPr2, PC	Use these buttons to switch directly to a video source.
21	INFO	Use the INFO button to display the current signal status.



Picture-in-Picture Description

Main picture mode

- You can change the signal source of the main picture through the MAIN MODE of your remote control.
The signal source you choose appears on the upper left corner of the screen (diagram 1).
- The main picture will be changed in the sequence as follows: TV/CVBS(AV)/S-VIDEO/SCART (for Europe only)/YPbPr1/YPbPr2 or D4 (for Japan only)/VGA.
- Users are allowed to set the options specifically designed for a certain mode under the OSD MENU.

PIP mode

- LCD display can display the main signal and auxiliary visual input signals simultaneously.
The auxiliary signal (or input source) appears in a frame on the main picture. This is known as PIP picture (diagram 1). To activate PIP mode from the PIP button on the remote controller.
- Please select the PIP input source from the SOURCE button on the remote controller. There is no PIP button on the LCD display control panel.
- The sub-signal options change as the main signal source changes. (Diagram 2)

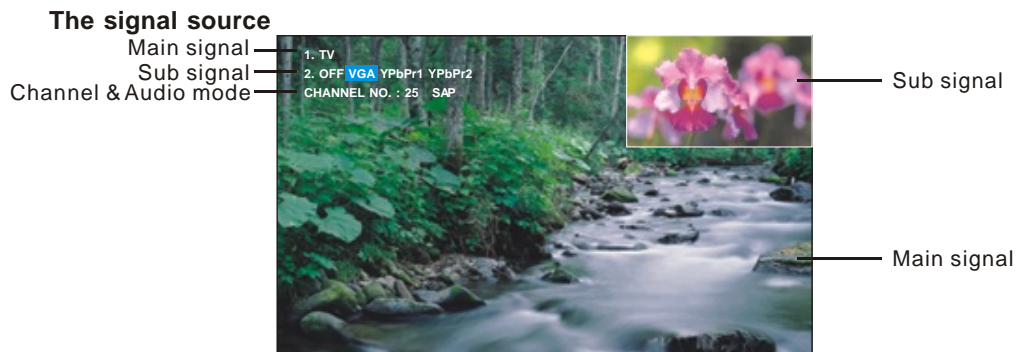

(Diagram 1)

Sub signal (PIP) \ Main signal	OFF	TV	AV (CVBS)	SV (S-VIDEO)	SCART (For Europe only)	YPbPr1	YPbPr2 D4 (For Japan only)	VGA (PC)
TV	✓	—	—	—	—	✓	✓	✓
CVBS(AV)	✓	—	—	—	—	✓	✓	✓
S-VIDEO	✓	—	—	—	—	✓	✓	✓
SCART (For Europe only)	✓	—	—	—	—	✓	YPbPr2 ✓ D4 —	✓
YPbPr1	✓	✓	✓	✓	✓	—	—	—
YPbPr2 D4 (For Japan only)	✓	✓	✓	✓	YPbPr2 ✓ D4 —	—	—	—
VGA (PC)	✓	✓	✓	✓	✓	—	—	—

(Diagram 2)



Display Menu

1. Users can use either the MAIN MODE button or the quick selection button on the remote control to select the proper mode. Once the signal source is detected, the system mode selected by users appears on the upper left corner of the screen.
2. After the system mode is selected, users can press MENU buttons to execute the following functions:



AUTO (automatic adjustment) (can be used under PC mode)
Allows you to adjustment the setup of picture automatically.



DISPLAY (picture display)
Provides more picture modes and functions based upon your favorite programs and lets you adjust the setup regarding colors and brightness.



TV (to be used under TV mode)
Allow you to set your favorite channels. If you use several systems and input signal sources, this function executes the automatic programs.



GEOMETRIC (geometric adjustment) (to be used under PC mode)
Allows you to adjust the position and sharpness of picture.







AUDIO (audio setup)
Provides more audio selections. You can also set the audio environment for your LCD display.



MISCELLANEOUS (other setups)
Provides several options and allows you to set the automatic closing hour, language, and restore the default.



	Items	Range	Activation mode	
DISPLAY	CONTRAST	0 ~ 50	TV/S-VIDEO/AV/YPbPr1/YPbPr2/SCART/D4/PC	
	BRIGHTNESS	0 ~ 50	TV/S-VIDEO/AV/YPbPr1/YPbPr2/SCART/D4/PC	
	COLOR-TEMP	High / Middle / Low / User	PC	
	RED	0 ~ 255	PC	
	GREEN	0 ~ 255	PC	
	BLUE	0 ~ 255	PC	
	WHITE BALANCE		PC	
	COLOR	0 ~ 50	TV/S-VIDEO/AV/YPbPr1/YPbPr2/SCART/D4	
	HUE	0 ~ 50	TV/S-VIDEO/AV/YPbPr1/YPbPr2/SCART/D4	
	SHARPNESS	0 ~ 6	TV/S-VIDEO/AV/YPbPr1/YPbPr2/SCART/D4	
	FOCUS	0 ~ 31	YPbPr1/YPbPr2/SCART/D4	
	NOISE FILTER	ON / OFF	TV/S-VIDEO/AV/SCART	
	RESET< / >		TV/S-VIDEO/AV/YPbPr1/YPbPr2/SCART/D4/PC	
	TV	CCD	CC1~CC4 / T1~T4 / OFF	TV/AV (For NTSC)
		V-CHIP		TV/S-VIDEO/AV (For NTSC)
	CHANGE PASSWORD	0000 ~ 9999	TV/S-VIDEO/AV (For NTSC)	
	CH SCAN	0 ~ 125	TV	
	CATV / AIR	ANTENNA / CABLE	TV (For NTSC)	
	CH ADD / DEL	+ / -	TV (For NTSC)	
GEOMETRIC	CLOCK	0 ~ 255	PC	
	PHASE	0 ~ 31	PC	
	H-POSITION	0 ~ 255	PC	
	V-POSITION	0 ~ 255	PC	
	RESET< / >		PC	
	AUDIO	VOLUME	0 ~ 31	TV/S-VIDEO/AV/YPbPr1/YPbPr2/SCART/D4/PC
	BASS	0 ~ 24	TV/S-VIDEO/AV/YPbPr1/YPbPr2/SCART/D4/PC	
	TREBLE	0 ~ 24	TV/S-VIDEO/AV/YPbPr1/YPbPr2/SCART/D4/PC	
	SUBWOOFER	ON / OFF	TV/S-VIDEO/AV/YPbPr1/YPbPr2/SCART/D4/PC	
	SURROUND	ON / OFF	TV/S-VIDEO/AV/YPbPr1/YPbPr2/SCART/D4/PC	
	BALANCE	L ~ 0 ~ R	TV/S-VIDEO/AV/YPbPr1/YPbPr2/SCART/D4/PC	
	RESET< / >		TV/S-VIDEO/AV/YPbPr1/YPbPr2/SCART/D4/PC	
MISCELLANEOUS	OSD TIMER	5/10/15/20/25/30 SEC	TV/S-VIDEO/AV/YPbPr1/YPbPr2/SCART/D4/PC	
	LANGUAGE	ENGLISH/DEUTESH/FRANCOIS/ ITALIA NO/ESPANOL/JAPAN /繁/簡	TV/S-VIDEO/AV/YPbPr1/YPbPr2/SCART/D4/PC	
	PIP SIZE	1, 2, 3, 4, 5	TV/S-VIDEO/AV/YPbPr1/YPbPr2/SCART/D4/PC	
	PIP POSITION	0 ~ 4	TV/S-VIDEO/AV/YPbPr1/YPbPr2/SCART/D4/PC	
	RESET< / >		TV/S-VIDEO/AV/YPbPr1/YPbPr2/SCART/D4/PC	



Menu is changed as the picture mode and district are changed.



Display

1. Press MENU button on the remote controller to display the main menu.
2. Press ◀ ▶ button on the remote controller to select the Display to be adjusted.
3. Press ▲ ▼ button on the remote controller to select the item to be adjusted.
4. Press ◀ ▶ button on the remote controller to adjust the default of that item.
5. Press MENU again to quit the picture.

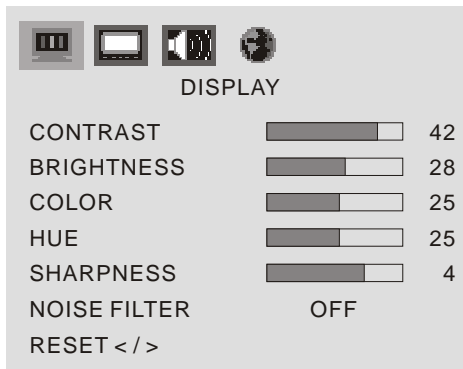

(For TV/S-VIDEO/AV/SCART)

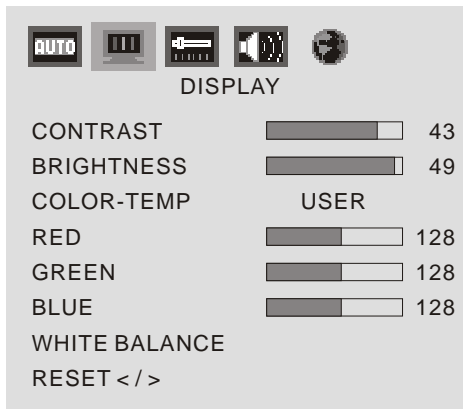

(For PC)

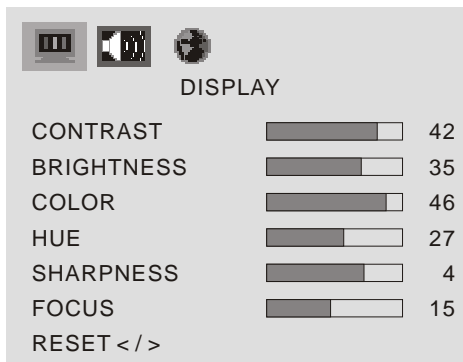

(For YPbPr1/YPbPr2/D4)

Menu	Descriptions
Contrast	Press ◀ ▶ to increase or decrease the picture contrast .
Brightness	Press ◀ ▶ to make picture brighter or darker.
Color Temp	Press ◀ ▶ to select color temps.
Red	Press ◀ ▶ to increase or decrease the red of the picture.
Green	Press ◀ ▶ to increase or decrease the green of the picture.
Blue	Press ◀ ▶ to increase or decrease the blue of the picture.
White Balance	In the PC Mode, select all white for the center of picture; and then press ◀ ▶ to make the color balanced.
Color	Press ◀ ▶ to increase or decrease the thickness of color.
Hue	Press ◀ ▶ to change the colors to be redder or greener.
Sharpness	Press ◀ ▶ to make the picture sharper or softer.
Noise Filter	Press ◀ ▶ to choose on or off to make the picture more clear.
Focus	Press ◀ ▶ to make the signal sharper or softer.
Reset </ >	Press this button to restore all setups of the Display to the default.

TV

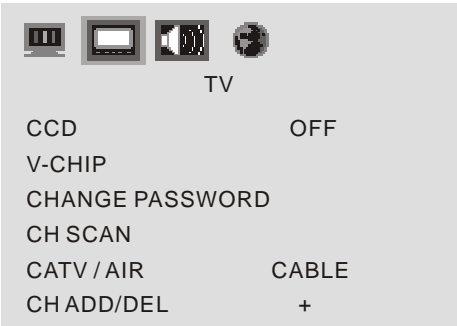

1. Press MENU button on the remote controller to display the main menu.
2. Press ◀ ▶ button on the remote controller to select the main item (TV) to be adjusted.
3. Press ▲ ▼ button on the remote controller to adjust the setup of that item.
4. Press ◀ ▶ button on the remote controller to adjust the default of that item.
5. Press MENU button again to quit the picture.

Descriptions
CCD (This function is designed for American NTSC system only) Use this function to activate the subtitle function.
V-CHIP (grading system) (This function is designed for American NTSC system only) Enter password to activate the MENU of V-CHIP. You can press ◀ ▶ button to select the grade you want; and then press ▲ ▼ button to set up if you'd like to watch the programs. (Please refer to Table 1 and Table 2 as follows)
Change Password (change the password for grading)(This function is designed for American NTSC system only) Press ◀ ▶ button and enter the original password (defaulted as 0000). You'll see the New Password picture. Enter the password you choose and quit.
CH Scan (automatic channel scanning) At CH Scan, press ▶ button to execute the automatic channel scanning. You need to execute the automatic channel scanning if you install your LCD display for the first time.
CATV / AIR (TV signal source) Antenna Cable Press ◀ ▶ button on the remote controller to select the item you'd like to use. Cable : please set this item if you receive programs through CATV. Antenna : please set this item if you receive programs through antenna.
CH ADD/DEL Press ◀ ▶ button on the remote controller to select the item you'd like to +(ADD) / - (DEL) the channel.

V-CHIP MPAA-RATING					
G	PG	PG-13	R	NC-17	X
U	U	U	U	U	U
		TV-RATING			
	FV	V	S	L	D
TV-Y7	U				
TV-PG		U	U	U	U
TV-14		U	U	U	U
TV-MA		U	U	U	

(Table 1)

 B : prohibited (not allowed to watch this program)
U : not prohibited (allowed to watch this program)

TV RATING	Y7 suitable for older kids PG parental guidance required 14 parents should be aware if the programs are suitable for children MA adults only FV fantasy and violence D some sexual content and dialogue L low level of content and profanity S Sex V Violence
MAPP RATING	G suitable for children and average audience PG parental guidance required PG-13 suitable for kids less than 13 years under parental supervision R rated, children under 17 should be accompanied by parents NC-17 children under 17 are not allowed X former grading, has merged with NC-17, but can be seen in older movies.



Geometric

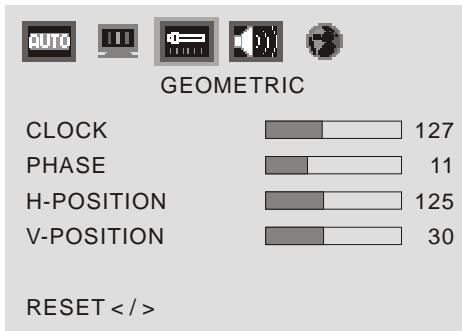

1. Press MENU button on the remote controller to display the main menu.
2. Press ◀ ▶ button on the remote controller to select the main item (Geometric) to be adjusted.
3. Press ▲ ▼ button on the remote controller to select the item you'd like to adjust.
4. Press ◀ ▶ button on the remote controller to adjust the default of that item.
5. Press MENU button again to quit the picture.

Menu	Descriptions
Clock	Press ◀ ▶ button to adjust the alignment of VGA for steady display of VGA.
Phase	Press ◀ ▶ button to adjust the focus and sharpness of VGA.
H-Position	Press ◀ ▶ button to adjust the horizontal position of VGA.
V-Position	Press ◀ ▶ button to adjust the vertical position of VGA.
Reset< / >	Press this button to restore all Geometric setups to default.



Audio

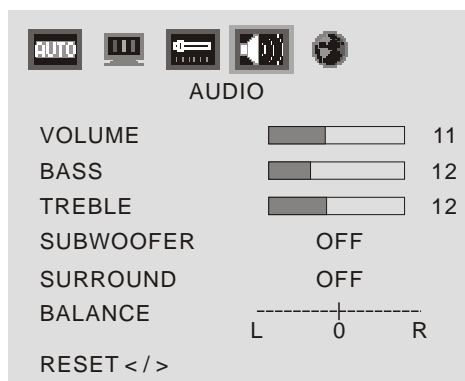

1. Press the MENU button on the remote controller to display the main menu.
2. Press ◀ ▶ button on the remote controller to select the main item (Audio) to be adjusted.
3. Press ▲ ▼ button on the remote controller to select the item to be adjusted.
4. Press ◀ ▶ button on the remote controller to adjust the default of that item.
5. Press MENU button again to quit the picture.

Menu	Descriptions
Volume	Press ◀ ▶ button and adjust the volume to the level you want.
Bass	Press ◀ ▶ button to increase or decrease the volume.
Treble	Press ◀ ▶ button to increase or decrease the volume of pitch sound.
Subwoofer	Press ON or OFF to activate or inactivate the subwoofer filter.
Surround	Press ON or OFF to activate or inactivate the surround sound effect.
Balance	Press ◀ ▶ button to adjust the balance between right and left speakers.
Reset< / >	Return all Audio items to default by pushing the left or right arrow keys.



Miscellaneous

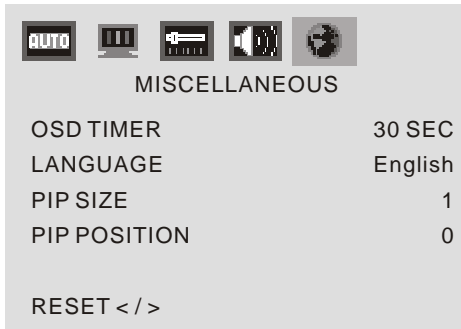

1. Press the MENU button on the remote controller to display main menu.
2. Press ◀ ▶ button on the remote controller to display the main item (Miscellaneous) to adjust.
3. Press ▲ ▼ button on the remote controller to select the item to be adjusted.
4. Press ◀ ▶ button on the remote controller to adjust the default of that item.
5. Press MENU again to quit the picture.

Menu	Descriptions
OSD Timer	Press ◀ ▶ button to select the time to be shown on the menu 5 sec 15 sec 20 sec 25 sec 30 sec
Language	Press ◀ ▶ button to select language English/French/Spanish/German/Italian/Japanese/Chinese(Traditional)/Chinese(Simplified)
PIP Size	Press ◀ ▶ button to select the size of small picture. (5 size) (Please execute this function under PIP Mode)
PIP Position	Press ◀ ▶ button to move the small to upper left, upper right, center, lower left, or lower right.(Please execute this function under PIP Mode)
Reset< / >	Return all Miscellaneous items to default.



Appendices

Trouble-Shooting

Q: Why doesn't my video **fill** the whole screen?

A: Some people prefer to maintain the original aspect ratio to avoid seeing abnormally fat or skinny characters. Other people prefer to fill more of the screen. Use the **SCALING** button on your remote to adjust the image aspect ratio and fill more of the screen.

Q: Why do I have to keep changing the **SCALING** adjustment?

A: Each type of programming content may be different. Most NTSC TV programs and videotapes are 4:3 aspect ratio. DVD movies are available in several formats and can be adjusted accordingly. HD content is typically wide format. Occasionally DVD movies and TV programs are letterboxed and can be zoomed to fill the entire screen.

Q: I have no video from my **progressive** DVD player. How do I fix this?

A: You may need to connect the DVD player to another video input. Match the settings on your DVD player to progressive or interlaced output. For progressive output, use a YPbPr input on the LCD-TV.

Q: I have no video from the **HDTV** input. What is wrong?

A: Adjust the settings on your HD receiver to 720p, 1080i or 480p output. On the Sony SAT-HD200, this button is on the front panel and remote. For the Samsung model SIR-TS160, this switch is on the rear panel.

Q: Will a **progressive scan** DVD player provide better video?

A: This LCD-TV includes a progressive scan converter that is comparable to the scan-converter built into progressive scan DVD players.

Q: What are **anamorphic** widescreen DVD movies?

A: There are two common ways of recording wide format movies on a DVD: letterbox and anamorphic. Anamorphic recordings are also commonly labeled "**Enhanced for 16:9 TV's**". Anamorphic recordings have over 30% more vertical resolution than letterbox format. Use the **SCALING** button on your remote to adjust the image aspect ratio and fill more of the screen.

Q: Do LCD's have a **burn-in** problem?

A: No. Unlike CRT and plasma TV's, liquid crystal displays (LCD) do not use phosphor and thus have no problems with a still image becoming permanently stored on the screen.

Q: Can I use a **game console** such as Sony Playstation 2, Nintendo Game Cube or Microsoft XBOX with my LCD-TV?

A: Yes. If you intend to use a game console and/or watch standard TV broadcasts over cable, satellite or antenna, an LCD-TV is a necessary and superior choice over widescreen plasma and CRT televisions. The repetitive image from games and unused black filled borders will damage a plasma TV by burning a permanent image into the phosphor.



Q: Will leaving my LCD-TV on cause the image to degrade?

A: No. Unlike plasma TV's, this LCD-TV does not exhibit **aging** over time. The brightness of the image remains the same. Sufficient airflow is important to maintain a cool operating temperature.

Q: I forgot my **parental control password**. How do I reset the parental control?

A: Enter 00000 as the password.

Q: I have video, but no audio. What's up?

A: Adjust the volume up, turn off the mute button, and confirm the audio cables for this video source properly are connected.

Q: I have audio, but no video. What's up?

A: Match the video output format (720p, 1080i, 480p, 480i) of your video source to the appropriate input connector on the LCD-TV.

Q: I am using the component video input. Why are the colors all wrong?

A: Confirm the Pb and Pr cables are not switched by matching the color codes on the cable to the connectors.

Q: My cable TV reception is not very clear. Why is this?

A: Many homes split a signal from their antenna or cable many times. The number of splitters and the quality of the connectors on the 75ohm cable will visibly affect TV reception. Computers, microwave ovens and other electronic devices emit electronic noise. Identify the interfering device by shutting it off and try relocating the interfering device away from your LCD-TV.

Q: My computer images appear stretched. How do I fix this?

A: Adjust the display properties of your PC to 1280x720. (You may need to download a 1280x720 driver.)

Q: The text on my PC is too small. How do I make it larger?

A: Adjust the font size using the large system font (125%) found in your PC's Display Properties Settings under the Advanced button.

Q: The audio sounds "thin" and is missing bass sounds.

A: Adjust the audio bass and treble settings from the audio menu. Be sure to set the subwoofer value to off when there is no subwoofer.



Specifications

Active Range	Refresh Rate	H KHz	V Hz	Dot Clock MHz	Pol.		Horizontal				Vertical			
					H	V	Sync Width	Back Porch	Front Porch	Total	Sync Width	Back Porch	Front Porch	Total
640 × 350	70	31.5	70	25.175	N	N	96	48	16	800	2	60	37	449
640 × 480 VGA	60	31.469	59.940	25.175	N	N	96	48	16	800	2	33	10	525
	72	37.861	72.809	31.5	N	N	40	128	24	832	3	28	9	520
	75	37.5	75	31.5	N	N	64	120	16	840	3	16	1	500
	85	43.269	85.008	36	N	N	56	80	56	832	3	25	1	509
720 × 400	70	31.46	70.08	28.32	N	P	108	54	18	900	2	35	12	449
800 × 600 SVGA	56	35.156	56.250	36	P	P	72	128	24	1024	2	22	1	625
	60	37.879	60.317	40	P	P	128	88	40	1056	4	23	1	628
	72	48.077	72.188	50	P	P	120	64	56	1040	6	23	37	666
	75	46.875	75	49.5	P	P	80	160	16	1056	3	21	1	625
	85	53.674	85.061	56.25	P	P	64	152	32	1048	3	27	1	631
1024 × 768 XGA	60	48.363	60.004	65	N	N	136	160	24	1344	6	29	3	806
	70	56.476	70.069	75	N	N	136	144	24	1328	6	29	3	806
	75	60.023	75.029	78.75	P	P	96	176	16	1312	3	28	1	800
1280 × 720	60	44.772	59.855	74.5	N	P	128	192	64	1664	5	20	3	748
1280 × 1024	60	63.981	60.020	108	P	P	112	248	48	1688	3	38	1	1066



Specifications

Display panel	Screen Size	597.12(H) X 335.88(V)mm (diagonal 26.97 inches)
	Aspect Ratio	16:9 WIDE
	Pixel Pitch	0.1555(H) X 0.4665(V)mm
	Number of Pixels	1280(H) X 720(V)
	Luminance	500cd/m ² (Typical)
	Contrast	500:1(Typical)
	Response Time	16ms
	Viewing Angle	Typical 170 Degree(Horizontal/Vertical)
	Colors	16.7 Million
Signals Input/out	*Video in	RCA Jack X 1
	*Scart	RGB + Audio/Composite + Audio(Europe region)
	*S-Video in	Y/C X 1
	*Component in	YPbPr(USA X 2,EuropeX2,JapanX1)
	*Tuner in	NTSC/PAL/SECAM(OPTIONAL)
	*EIAJ-D4	Mini-D 14 pin(Japan region)
	Audio in	* RCA Jack(R+L)X 4
		PC Audio In X 1
	RGB in	D-sub 15 pin 3 row type
	Audio out	RCA Jack(R+L) X 1 / Subwoofer RCA Jack X 1
	PIP	1 Mode (5 Size)
	Display Mode	4:3 Mode, Panoramic, Fill All, Wide
Compatibility	Color system	NTSC/PAL/SECAM
	Video system	NTSC/PAL/SECAM
	PC/Mac	VGA/SVGA/XGA/SXGA
	SDTV/HDTV scanning format	1080i, 720p, 480p, 480i (NTSC) 576p, 576i (PAL)
Audio Output	Built-in speaker	8w + 8w (Stereo)
	Subwoofer	RCA Jack X 1
Regulation	Safety / EMC	UL/CUL, VCCI, CB, CE, FCC Class B
	Accessories	VGA Cable / Power Cable User's Manual / Warranty Card
		* AV Cable/ Remote controller / Batteries
Other	Dimensions with / without stand	83.1 X 20 X 47.6 cm / 83.1 X 10 X 42.4 cm
	Package Size	96 X 31 X 61 cm
	Net Weight / Gross Weight	18 kg /23.8 kg
	Power Source	Input : 100-240V, 1.8A, 50-60Hz
	Operative temperature	0~40 °C

! * denotes optional item



Wall Mounting

Use a qualified and insured professional installation service to mount your LCD-TV on a wall. Improper mounting can cause this LCD-TV to fall and both be damaged and cause severe damage. The wall mounting bracket and screws are sold separately and not included with this product. This product conforms to VESA flat panel display mounting interface specification. **Be sure the mounting solution can support more than the weight of the 27" LCD-TV, 18kg (40lb).**

Please provide the mounting kit and these instructions to the installation professional:

- A. Turn off and unplug the LCD-TV. Place your LCD display face down on a soft clean surface paying particular attention not to scratch the LCD surface, speakers or enclosure.
- B. Remove the TV stand by unscrewing the 6 screws attaching the base from the LCD-TV as shown in figure B. Save the 6 screws and stand in a safe place.
- C. Screw and securely **tighten** the 4 wall hanging screws into the rear of the LCD-TV as shown in figure C.
- D. Locate several studs in the wall. Attach the mounting bracket **securely** to multiple studs in the wall. Often one or more wood cleats are required to allow the mounting bracket to be located between studs. Double-check for strength to support more than the weight of the 27" LCD-TV, 18kg (40lb). See figure D.
- E. Attach any cables to your LCD-TV at this time.
- F. Carefully place the LCD-TV on the wall-mounting bracket by matching up the 4 wall hanging screw heads to the corresponding holes in the mounting bracket.
- G. Carefully test for strength before releasing the LCD-TV.

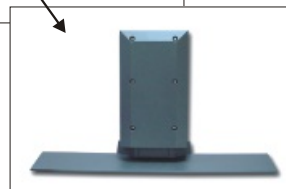
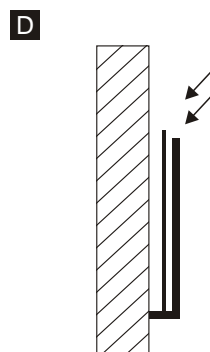
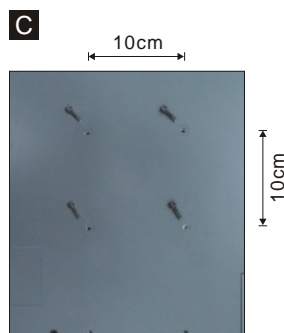
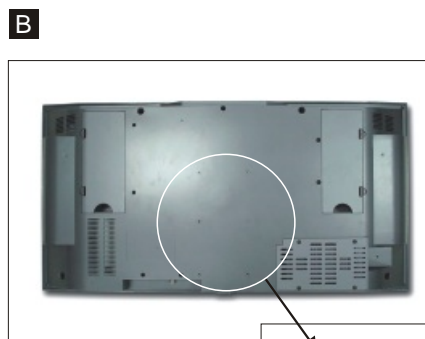



Important Safety Instructions

Read the following instructions carefully. Follow all instructions and heed all warnings to prevent personal injury or damage to the product. Keep these instructions in a safe place for future reference.

- To reduce the risk of fire or electric shock, do not expose this appliance to rain or moisture. Do not place your LCD-TV near water. Exposing the apparatus to rain, water, moisture or sunlight can severely damage it.
- Clean only with a soft dry cloth.
- Do not block ventilation openings. Increased temperature may cause fire or device failure.
- Install in accordance with the manufacturer's instructions.
- Do not place the apparatus near any heat sources such as radiators, heat registers, stoves, or other apparatus (including amplifiers) that produce heat.
- Only use the attachments and accessories that were included with the apparatus.
- Use only with the cart, stand, tripod, bracket, or table specified by the manufacturer, or sold with the apparatus. When a cart is used, use caution when moving the cart/apparatus combination to avoid injury from tip-over.
- Refer all servicing to qualified service personnel.
- If you notice smoke or any other odor or noise coming from the apparatus, stop using the product immediately and unplug the power cord. Contact a qualified service technician.
- Keep the apparatus at least four (4) inches away from the wall. Make sure there is sufficient airflow to ventilate the unit.
- Hold the apparatus with two hands at the base of the panel when moving it.

Caution: To reduce the risk of electric shock, do not remove cover (or back). No user-serviceable parts inside. Refer servicing to qualified service personnel.



- 1) Read these instructions.
- 2) Keep these instructions.
- 3) Heed all warnings.
- 4) Follow all instructions.
- 5) Do not use this apparatus near water.
- 6) Clean only with dry cloth.
- 7) Do not block any ventilation openings. Install in accordance with the manufacturer's instructions.
- 8) Do not install near any heat sources such as radiators, heat registers, stoves, or other apparatus (including amplifiers) that produce heat.
- 9) Do not defeat the safety purpose of the polarized or grounding type plug. A polarized plug has two blades with one wider than the other. A grounding type plug has two blades and a third grounding prong. The wide blade or the third prong are provided for your safety. If the provided plug does not fit into your outlet, consult an electrician for replacement of the obsolete outlet.
- 10) Protect the power cord from being walked on or pinched particularly at plugs, convenience receptacles, and the point where they exit from the apparatus.
- 11) Only use attachments/accessories specified by the manufacturer.
- 12) Use only with the cart, stand, tripod, bracket, or table specified by the manufacturer, or sold with the apparatus. When a cart is used, use caution when moving the cart/apparatus combination to avoid injury from tipover. 
- 13) Unplug this apparatus during lightning storms or when unused for long periods of time.
- 14) Refer all servicing to qualified service personnel. Servicing is required when the apparatus has been damaged in any way, such as power-supply cord or plug is damaged, liquid has been spilled or objects have fallen into the apparatus, the apparatus has been exposed to rain or moisture, does not operate normally, or has been dropped.
- 15) To Reduce the Risk of Fire or Electric Shock, Do not Expose This Apparatus To Rain or Moisture.
- 16) Apparatus shall not be exposed to dripping or splashing and no objects filled with liquids, such as vases, shall be placed on the apparatus.
- 17) **TO REDUCE THE RISK OF ELECTRIC SHOCK, DO NOT REMOVE COVER (OR BACK).**
NO USER-SERVICEABLE PARTS INSIDE. REFER SERVICING TO QUALIFIED SERVICE PERSONNEL.

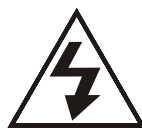

The lightning flash with arrow head symbol, within an equilateral triangle, is intended to alert the user to the presence of uninsulated "dangerous voltage" within the product's enclosure that may be of sufficient magnitude to constitute a risk of electric shock to persons.



The exclamation point within an equilateral triangle is intended to alert the user to the presence of important operating and maintenance (servicing) instructions in the literature accompanying the appliance.

**CAUTION!**

For use only with the following power supplies: Delta/ADP-150BB B; Delta/ADP-180CB B



FCC Statement

This device complies with Part 15 of the FCC Rules. Operation is subject to the following two conditions: (1) this device may not cause harmful interference, and (2) this device must accept any interference received, including interference that may cause undesired operation.

Note: This equipment has been tested and found to comply with the limits for a Class B digital device, pursuant to part 15 of the FCC Rules. These limits are designed to provide reasonable protection against harmful interference in a residential installation. This equipment generates, uses and can radiate radio frequency energy and, if not installed and used in accordance with the instructions, may cause harmful interference to radio communications. However, there is no guarantee that interference will not occur in a particular installation. If this equipment does cause harmful interference to radio or television reception, which can be determined by turning the equipment off and on, the user is encouraged to try to correct the interference by one of more of the following measures:

- Reorient or relocate the receiving antenna
- Increase the separation between the equipment and receiver
- Connect the equipment into an outlet on a circuit different from that to which the receiver is connected.

Caution: To comply with the limits for an FCC Class B computing device, always use the signal cord and power cord supplied with this unit. The Federal Communications Commission warns that changes or modifications to the unit not expressly approved by the party responsible for compliance could void the user's authority to operate the equipment.

Free Manuals Download Website

<http://myh66.com>

<http://usermanuals.us>

<http://www.somanuals.com>

<http://www.4manuals.cc>

<http://www.manual-lib.com>

<http://www.404manual.com>

<http://www.luxmanual.com>

<http://aubethermostatmanual.com>

Golf course search by state

<http://golfingnear.com>

Email search by domain

<http://emailbydomain.com>

Auto manuals search

<http://auto.somanuals.com>

TV manuals search

<http://tv.somanuals.com>