



Westinghouse

USER'S MANUAL
MANUEL DE L'UTILISATEUR
MANUAL DEL USUARIO

SK-26H730S
SK-26H540S

Widescreen HDTV

TVHD à Écran Géant

TVHD Pantalla Grande

TABLE OF CONTENTS

IMPORTANT SAFETY AND PRECAUTIONS	1
Important Information.....	1
Safety Precautions.....	2
GENERAL INFORMATION	4
Feature.....	4
Controls and Ports of the Panel.....	5
Accessories	9
Remote Control.....	10
INSTALLATION AND FUNCTION ADJUSTMENT	12
Installation.....	12
How to remove the BASE	15
Function adjustment	16
TROUBLESHOOTING	34
PC INPUT PRESET TIMMING TABLE	37
PRODUCT SPECIFICATION	39

English

Español

Français

IMPORTANT SAFETY AND PRECAUTIONS

This wide active matrix TFT (thin film transistor) liquid crystal monitor is designed for use as a stand alone TV as well as a display device for video electronics appliances and personal computers.

Important Information

Warning : To reduce the risk of fire or electric shock, do not expose this product to rain or moisture.

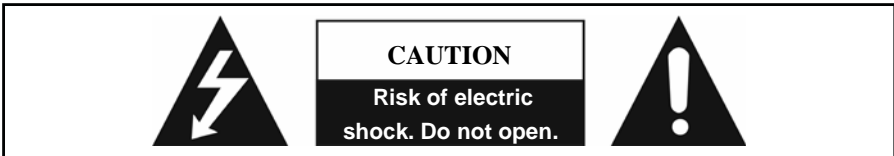

The symbol is intended to alert the user to presence of un-insulated "Hazardous Voltage" within the product's enclosure that may be of sufficient magnitude to constitute a risk of electric shock to persons.



The symbol is intended to alert the user that improper use of the product may result in product malfunction. The user should pay attention to avoid accidents or unnecessary problems.

Caution : To reduce the risk of electric shock, do not attempt to disassemble or modify this device. There are no user-serviceable parts inside. Refer any service issues to qualified service personnel.

Caution : FCC/ CSA regulations state that any unauthorized changes or modifications to this equipment may void the user's authority to operate it.

Important: One Federal Court has held that unauthorized recording of copyrighted TV programs is an infringement of U.S. copyright laws. Certain Canadian programs may also be copyrighted and any unauthorized recording in whole or in part may be in violation of these rights.

According to industrial standards for LCD display technology; there are a certain number of allowable defective pixels. Although we produce panels with more than 99.9% active cells, there still may be some cells that do not produce light or remain constantly lit. For further information, please contact sales or technical support.

Safety Precautions

1. Cleaning : Unplug the power cord from the AC outlet before cleaning the product. Use a damp cloth to clean the product. Do not use liquid cleaners or aerosol cleaners.
2. Water and moisture : Do not use the product near water or areas of high moisture content such as swimming pools, bathtubs or wet basements.
3. Ensure that no water droplets remain on the screen. Water can cause permanent discoloration.
4. Heat sources : Keep the product away from heat sources such as radiators, heaters, stoves and other heat-generating products (including amplifiers).
5. For added protection during a lightning storm or for extended periods of non-use, unplug the power cord from the wall outlet and disconnect the antenna (if used). This will prevent damage to the product due to power line surges.
6. If an outside antenna is connected to the product, make sure the antenna is properly grounded so as to provide some protection against voltage surges. (Coaxial connector shielding from cable distribution system should be probably earthed.)

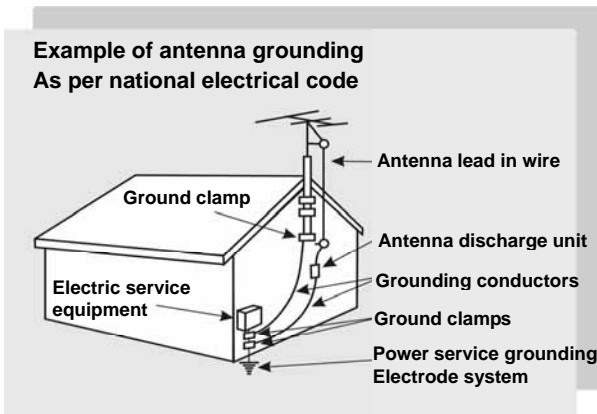

7. Stand : Do not place the product on an unstable cart, stand, tripod or table. Placing the product on an unstable base can cause the product to fall, resulting in serious personal injuries as well as damage to the product. Use only a cart, stand, tripod, bracket or table recommended by the manufacturer or sold with the product. Use only mounting hardware recommended by the manufacturer.



8. Use care when moving the product on a rolling cart. Sudden stops, excessive force and uneven floor surface can cause the product to fall from the cart.

9. Ventilation : The vents and other openings in the cabinet are designed for ventilation. Do not cover or block these vents and openings as insufficient ventilation can cause overheating and/or shorten the life of the product. Do not place the product on a bed, sofa, rug or other similar surfaces since they can block ventilation openings. This product was not designed to operate in an enclosed environment. Don't place the product in an enclosed space such as a bookcase or rack, unless proper ventilation is provided or the manufacturer's instructions are followed.

10. The LCD panel used in this product is made of glass. Therefore, it can break if the product is dropped or struck.

11. During the LCD panel lifespan it is normal for a few pixels to become defective. Non-active pixels may appear on the screen as fixed points of red, blue or green. Refer pixel policy questions to the reseller for further clarification on acceptable loss.

12. An outside antenna system should not be located in the vicinity of overhead power lines or other electrical conduits. When installing an outside antenna, use extreme caution to prevent the antenna from coming into contact with said items, as contact with them may be fatal.

GENERAL INFORMATION

Feature

Your TV is designed with the latest technology and is a high-performance unit that includes the following special feature :

- ◆ Multi-sources input included RF IN, D-SUB, HDMIx2, Compositex2, S-Videox2, and Componentx2.
- ◆ Built-in combo tuner is able to receive ATSC, NTSC and Clear QAM Cable signals.
- ◆ Built-in 10W dual channel speakers.
- ◆ Embedded video enhance and noise Reduction features for the colorful and clearest picture possible.
- ◆ Provided multi-channel sound decoder for stereo and bilingual broadcasts.
- ◆ Automatic sleep timer control.
- ◆ Component video input for high definition TV programming (HDTV ready), resolution up to 720p, 1080i.

Controls and Ports of the Panel

Front Panel Views (SK-26H540S)

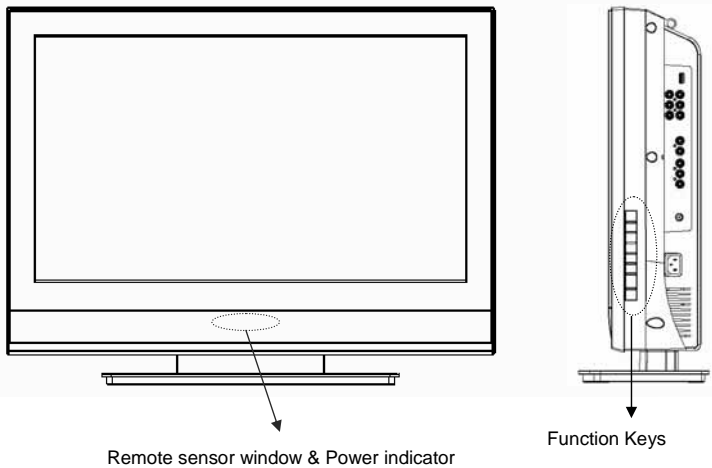

Remote sensor window & Power indicator

Function Keys

FUNCTION KEYS

1. **MENU** : Display the main menu. When OSD is appeared, press the button to select or access the sub-menu.
2. **VOLUME (+ / -)** : Increase/decrease the volume or be the left/right arrow button for menu.
3. **CHANNEL (+ / -)** : Change the channel or be the up/down arrow button for menu.
4. **SOURCE** : Select the input source (TV, Video 1, Video 2 , YPbPr, HDMI1, HDMI2, PC).
5. **POWER** : Turn the LCD-TV on or off.
6. **REMOTE SENSOR WINDOW** : aim the remote control towards this spot on the TV.
7. **POWER INDICATOR** :
 - WHITE LIGHT — power on
 - AMBER LIGHT — power sleep
 - EXTINGUISHED — power off

NOTE 1 : These buttons control the basic features of your TV, including the on-screen menu. To use advanced features, you must use the remote control.

NOTE 2 : The picture of LCD TV display is for reference only.

Front Panel Views (SK-26H730S)

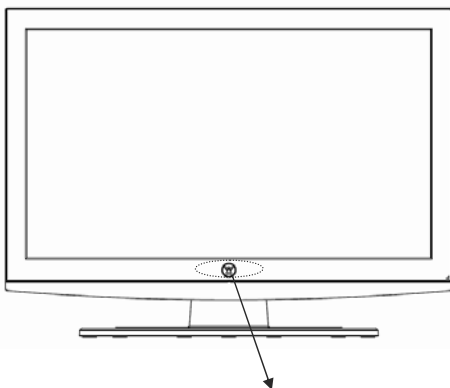

Remote sensor window & Power indicator

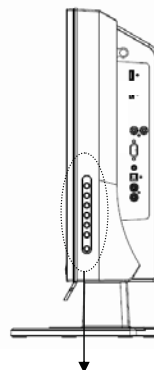

Function Keys

FUNCTION KEYS

1. **MENU** : Display the main menu. When OSD is appeared, press the button to select or access the sub-menu.
2. **VOLUME (+ / -)** : Increase/decrease the volume or be the left/right arrow button for menu.
3. **CHANNEL (+ / -)** : Change the channel or be the up/down arrow button for menu.
4. **SOURCE** : Select the input source (TV, Video 1, Video 2 , YPbPr, HDMI1, HDMI2, PC).
5. **POWER** : Turn the LCD-TV on or off.
6. **REMOTE SENSOR WINDOW** : aim the remote control towards this spot on the TV.
7. **POWER INDICATOR** :
WHITE LIGHT — power on
AMBER LIGHT — power sleep
EXTINGUISHED — power off

NOTE 1 : These buttons control the basic features of your TV, including the on-screen menu. To use advanced features, you must use the remote control.

NOTE 2 : The picture of LCD TV display is for reference only.

Side Panel Views (SK-26H540S)

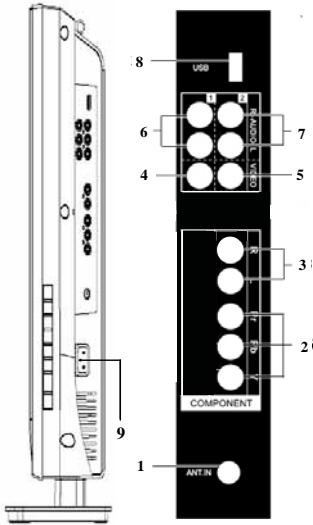

1. ANT.(RF input)
Connect the LCD TV to an over-the-air antenna or cable service to view NTSC and ATSC(HDTV) content.
2. YPbPr input
Connect an external video device with component output to this jack.
3. YPbPr Audio input(L/R)
Connect an external audio source to this jack.
4. Video1 input
Connect the Composite video to a legacy video such as a VCR or video game system.
5. Video2 input
6. Video1 Audio input
Connect an external audio source to this jack.
7. Video2 Audio input
8. USB
Factory service port
9. AC power in
Connect power cable to AC inlet.



10. Audio output(R/L)
Connect this output to an external stereo audio amplifier, receiver or surround sound processor with R/L audio inputs.
11. SPDIF output(Optical)
Connect this output to an external stereo audio amplifier, receiver or surround sound processor with SPDIF optical input.
12. VGA Audio in
Connect to the audio out(Green) from a computer.
13. VGA
Using a 15-pin VGA cable, connect to a computer.
14. HDMI Audio input(R/L)
Connect the audio input if you using a DVI-to-HDMI converter.
15. HDMI2 input
Connect to an external video device such as HD digital cable/satellite receiver, HD STB, Media center PC, or DVD player.
16. HDMI1 input

Side Panel Views (SK-26H730S)

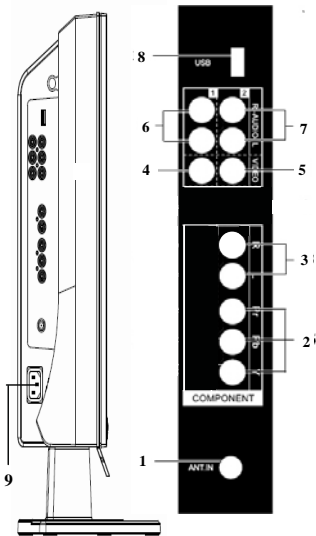

1. ANT.(RF input)
Connect the LCD TV to an over-the-air antenna or cable service to view NTSC and ATSC(HDTV) content.
2. YPbPr input
Connect an external video device with component output to this jack.
3. YPbPr Audio input(L/R)
Connect an external audio source to this jack.
4. Video1 input
Connect the Composite video to a legacy video such as a VCR or video game system.
5. Video2 input
6. Video1 Audio input
Connect an external audio source to this jack.
7. Video2 Audio input
Connect an external audio source to this jack.
8. USB
Factory service port
9. AC power in
Connect power cable to AC inlet.

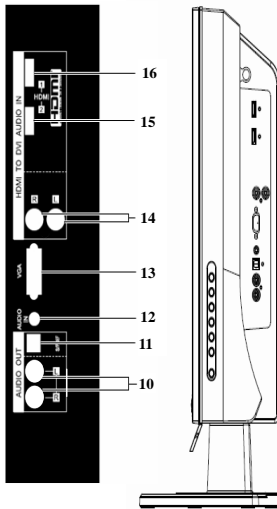

10. Audio output(R/L)
Connect this output to an external stereo audio amplifier, receiver or surround sound processor with R/L audio inputs.
11. SPDIF output(Optical)
Connect this output to an external stereo audio amplifier, receiver or surround sound processor with SPDIF optical input.
12. VGA Audio in
Connect to the audio out(Green) from a computer.
13. VGA
Using a 15-pin VGA cable, connect to a computer.
14. HDMI Audio input(R/L)
Connect the audio input if you using a DVI-to-HDMI converter.
15. HDMI2 input
Connect to an external video device such as HD digital cable/satellite receiver, HD STB, Media center PC, or DVD player.
16. HDMI1 input

Accessories



User's Manual

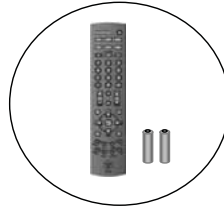

Remote Control & Batteries



Power Cord

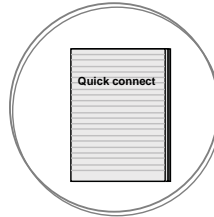

Quick Connect Guide



Warranty Card

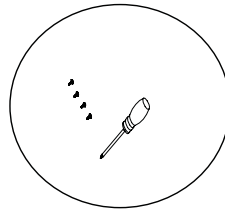

Screw driver & Screws x4(base)

Remote Control

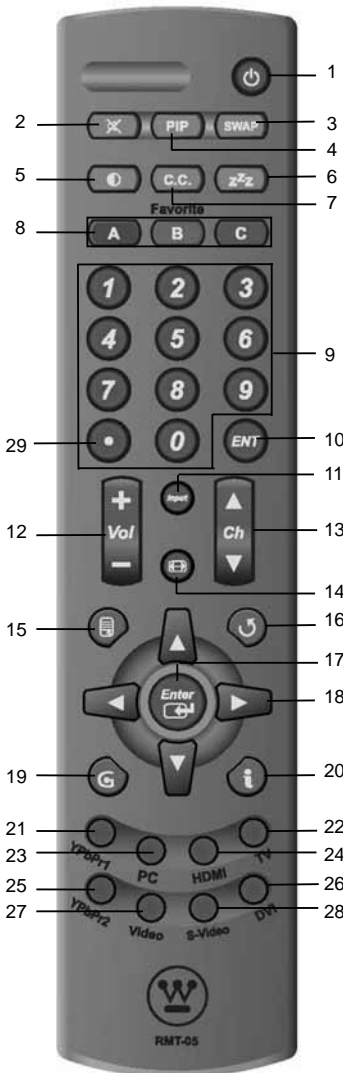

1	Power
	Switch TV power on/off.
2	Mute
	Turn the sound on/off.
3	Swap
	No support
4	PIP
	No support
5	Backlight
	Adjust the LCD Backlight level
6	Sleep
	Press to select a preset time interval for automatic power down.
7	CC
	Press to enable or disabled closed caption.
8	Favorite
	Press and hold programmable Key(A, B, or C). to save the current channel.
9	Channel number keys
	Select specific channel.
10	Enter
	Execute a command.
11	Input
	Select input source.
12	VOL +/-
	Volume Up/Down adjustment.
13	CH +/-
	TV channel Up/Down adjustment.
14	Screen Fit
	Select video display format "Standard" or "Fill".
15	Menu
	Display the User setup menu.
16	Return
	Switch to previous TV channel
17	Enter
	Execute a command.
18	▲/▼/◀/▶
	OSD manual control(▲/▼:TV channel Up/Down; ◀/▶:Volume Up/Down)

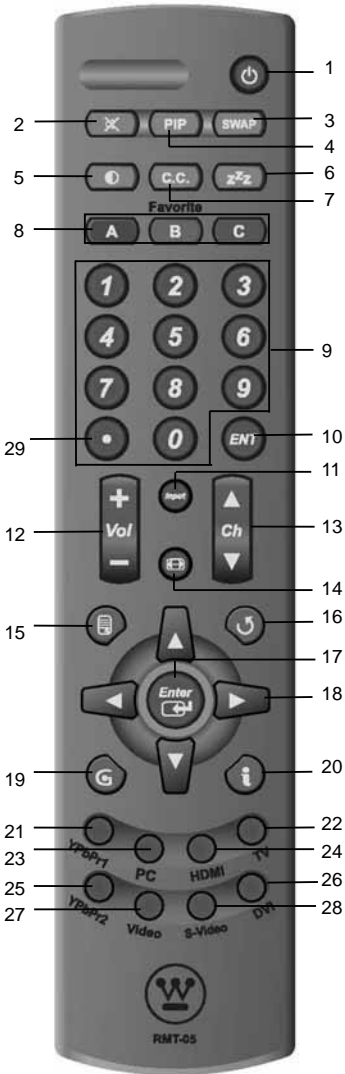

19	Guide
	Broadcast program information.
20	Info.
	Display the source and channel information.
21	YPbPr1
	Select YPbPr1 or 2 source input.
22	TV
	Select TV(NTSC/ATSC) source input.
23	PC
	Select VGA source input.
24	HDMI
	Select HDMI 1 or 2source input.
25	YPbPr2
	No support
26	DVI
	No support.
27	Video
	Select Video 1 or 2 input.
28	S-Video
	No support
29	Dot button
	Quicker access to all the available virtual channels

INSTALLATION AND FUNCTION ADJUSTMENT

Installation

1. Insert Batteries into Remote Control

- 1) Remove the battery cover.
- 2) Insert two size AAA batteries corresponding to (+) and (-) marks on the battery compartment.

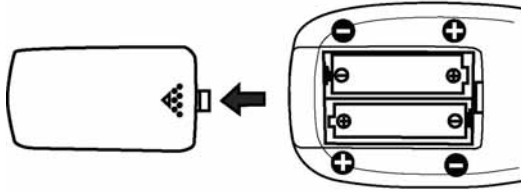

CAUTION

- Only use AAA batteries.
- Do not mix new and old batteries. This may result in cracking or leakage, which may pose a fire risk or lead to personal injury.
- Insert batteries according to (+) and (-) markings. Inserting the batteries incorrectly may result in cracking or leakage, which may pose a fire risk or lead to personal injury.
- Dispose of used batteries in accordance with local laws and regulations.
- Keep batteries away from children and pets.
- When the remote control will not be used for an extended period, remove the batteries.

2. Connections

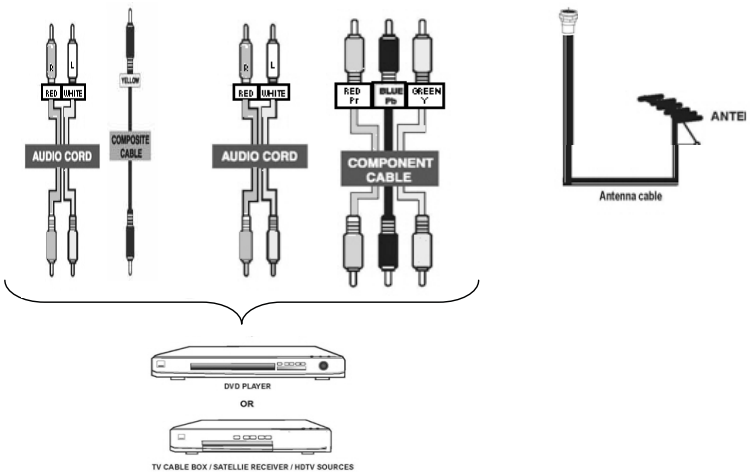
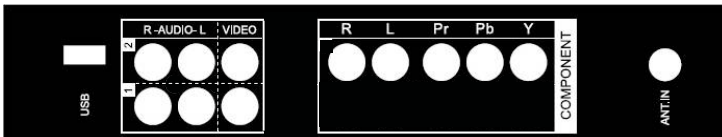
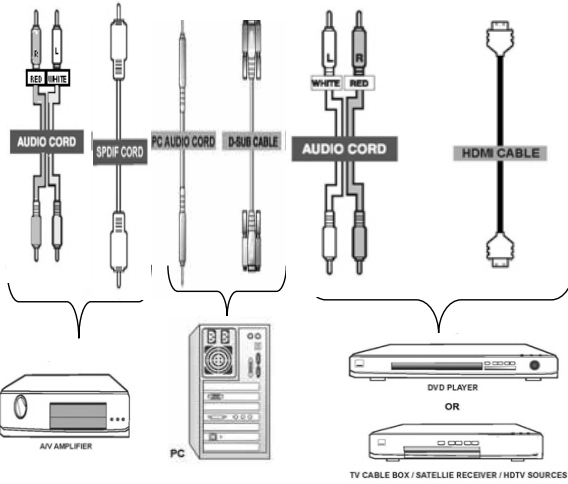
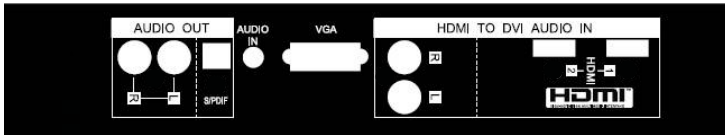

3. Connect power cables

Connect the power cord to the LCD TV then to a proper AC outlet.

IMPORTANT: The power input voltage for TV is 120Vac, before beginning; make sure all devices are turned off.

4. Turn Power On

Press the power button on the right side of the LCD TV, or press the power (Red) button on the remote control.

5. Select input source for the LCD TV using the OSD menu or remote control direct select buttons

6. If connecting to Antenna, Cable or other RF source on TV inputs:

See page 19 to scan and edit available channels.

7. If connecting to a PC(VGA):

For the best picture quality, set the timing of your computer to 1366 x 768 at 60Hz.

Refer to the graphic card's user guide of your computer to set this timing.

How to remove the BASE

- Carefully place the TV face down on a soft clean surface.
- Remove the four screws underneath the BASE.
(See picture below)
- Pull out the BASE from the TV.

SK-26H540S

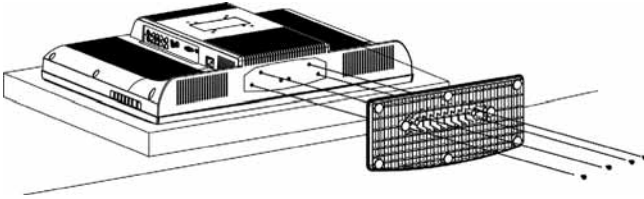

SK-26H730S

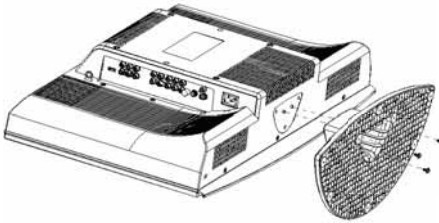

Function adjustment

There are four main Setup Menus; these are Settings, Channels, Locks and Guide. All the functions can be adjusted either by the remote control or by using the control keys on the LCD TV's right side.

Viewing OSD Menu

To display the main menu, press the Menu button on the right side of front control keys of the LCD TV or the MENU key on the remote control. Press arrow keys to select desired OSD menu and Enter key to select desired setting.

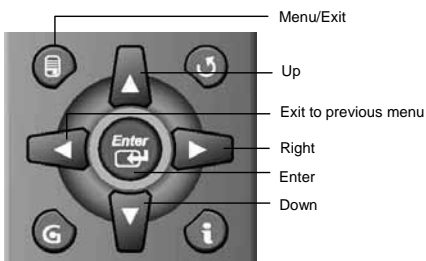

Picture

Picture including Settings, View Mode, Presets, Advanced, and Reset.

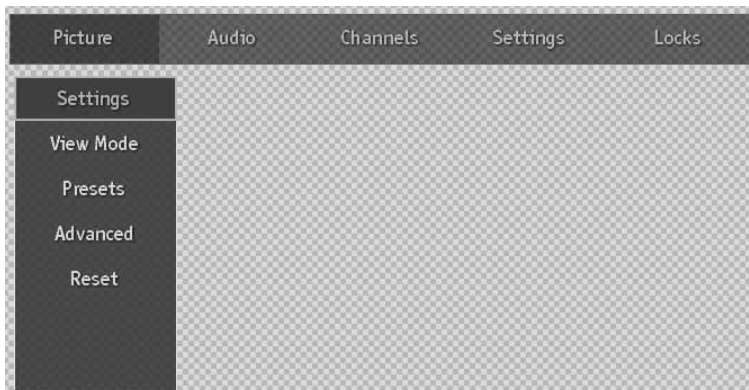

Settings

Settings including Brightness, Contrast, Hue, Saturation, Sharpness, and Backlight, please press arrow keys to select or adjust your favorite picture settings.

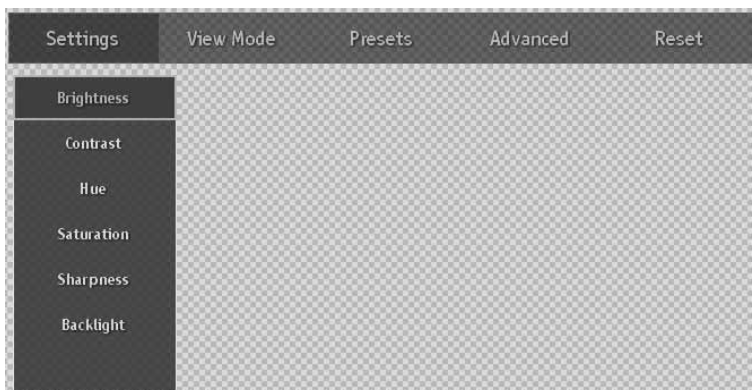

Brightness, Contrast, Hue, Saturation, Sharpness, Backlight

Press arrow keys to set value.



View Mode

Adjust your TV screen to handle different picture formats.

Standard/Fill/Overscan

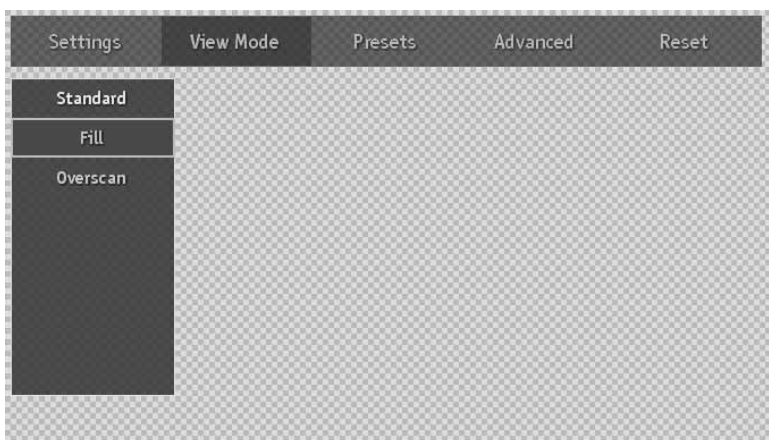

Presets

There are five presets mode for your favorite: Showroom, Game, Sports, Movie, and Custom.



Advanced

Advanced including Film Mode, Dynamic Contrast, Color Stretch, Noise Reduction, and Color Temperature.

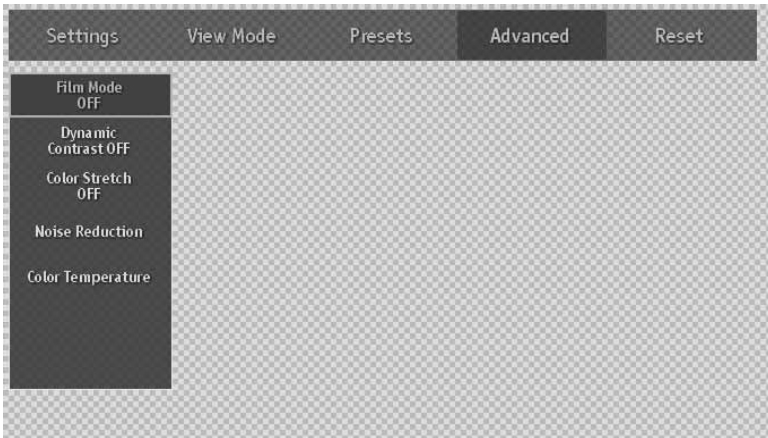

Film Mode, Dynamic Contrast, Color Stretch

Choose ON or OFF depend on your favor.

Noise Reduction

Press arrow keys to select or adjust your preferred settings.

Off/Low/Medi/High

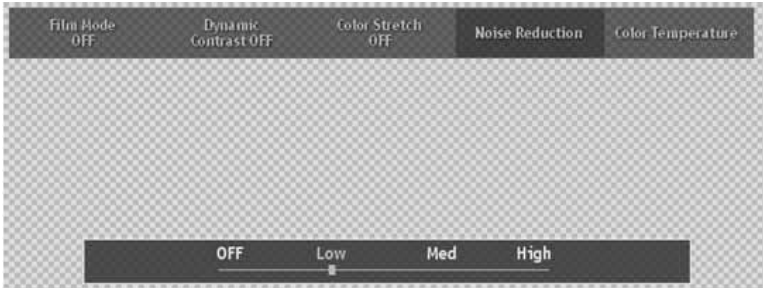

Color Temperature

Press arrow keys to select or adjust your preferred color temperature settings.

Cool/Neutral/Warm/Custom



Audio Setting



Bass, Treble, Balance

Use arrow keys to adjust value.



Analog Audio

Select an analog audio preference if TV signal is analog.

Mono/Stereo/SAP



Digital Audio

Select sound track for digital channels.

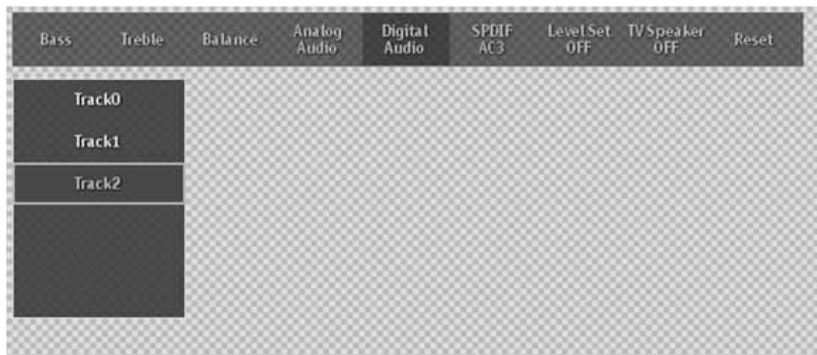

SPDIF

Select AC3/PCM

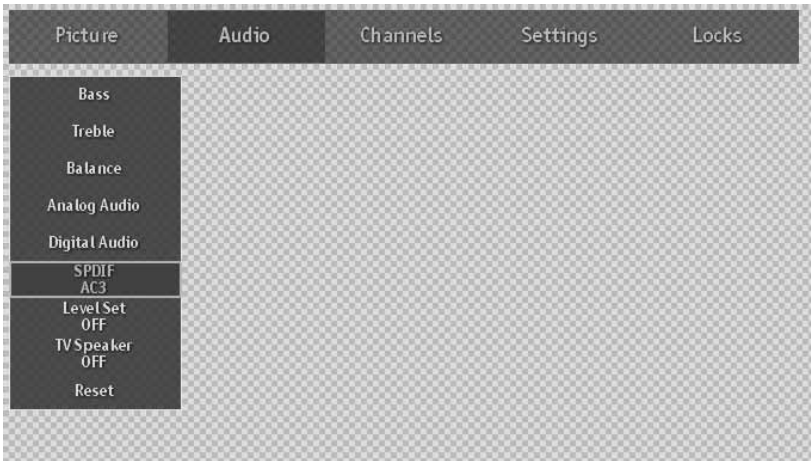

Level Set, TV Speaker

Select ON/OFF

English

Español

Français

Channels

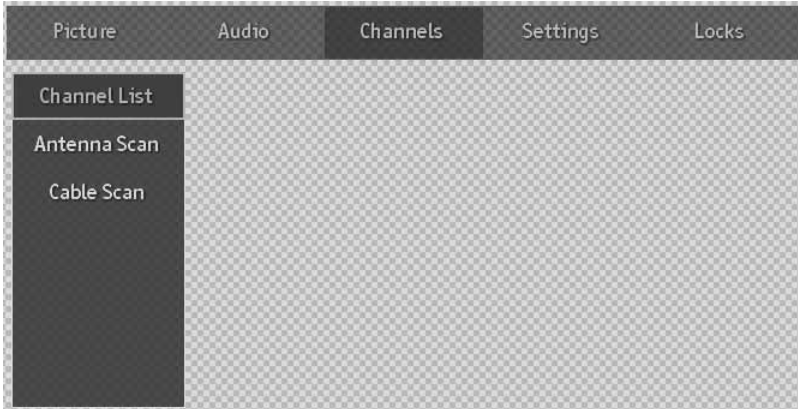

Channel list

To display which channels have been scanned.



Antenna Scan

To auto scan current available channels by using Antenna Scan.

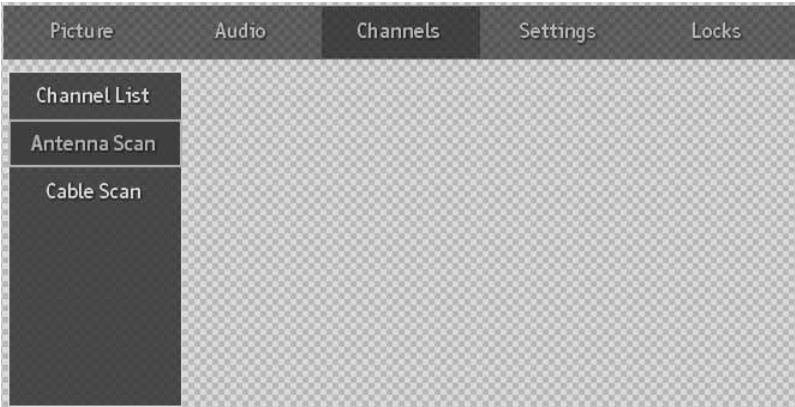

Cable Scan

To auto scan current available channels by using cable Scan.

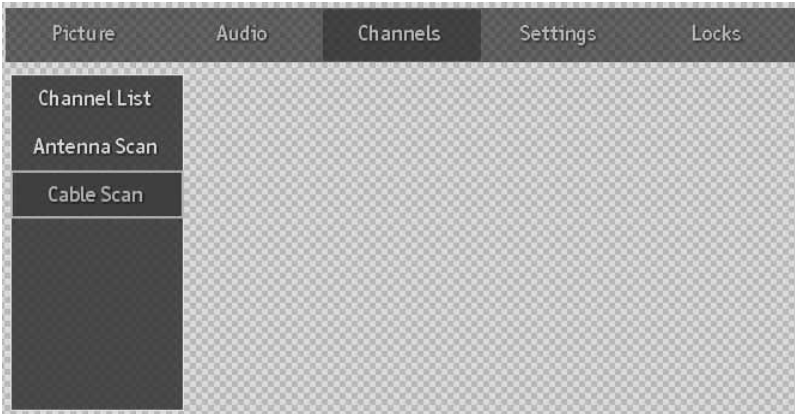

Settings



Close Captions

Set CC ON/OFF

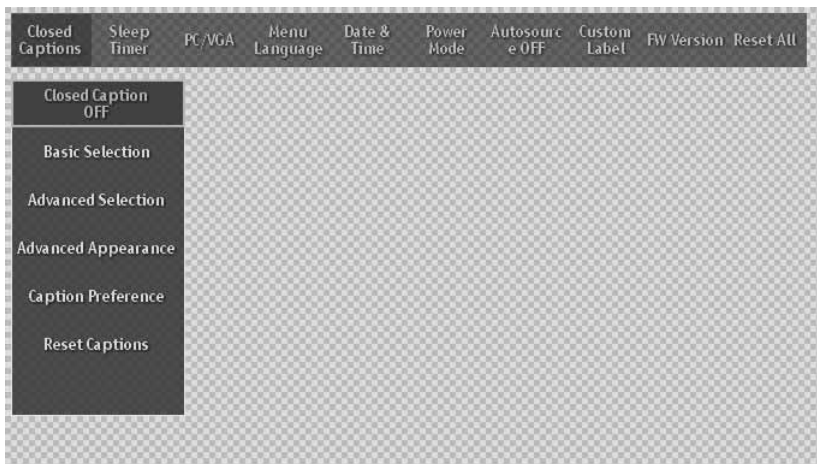

Basic Selection

Choose the type of closed caption settings to use for programs broadcast with basic caption

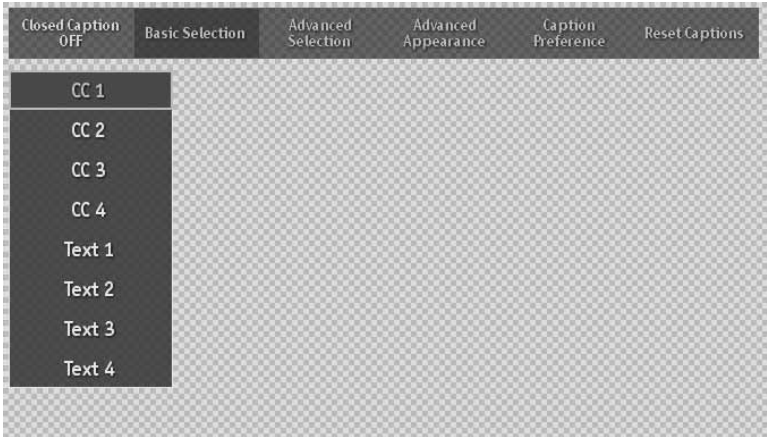

Advanced Selection

Choose the type of Advanced closed caption

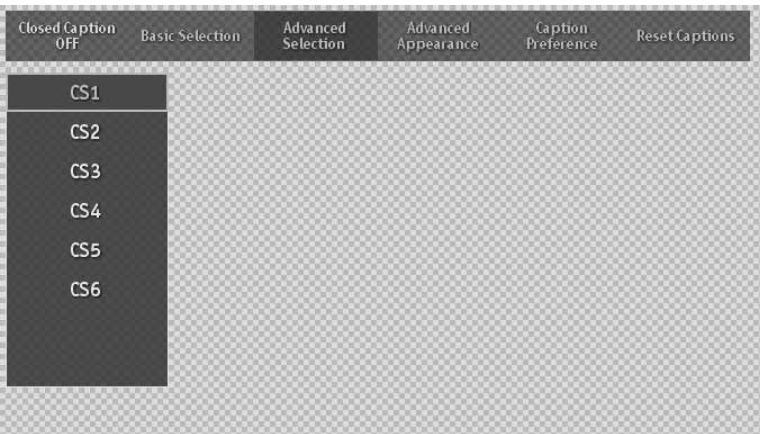

Advanced Appearance

Set the appearance of advanced Closed Captions.

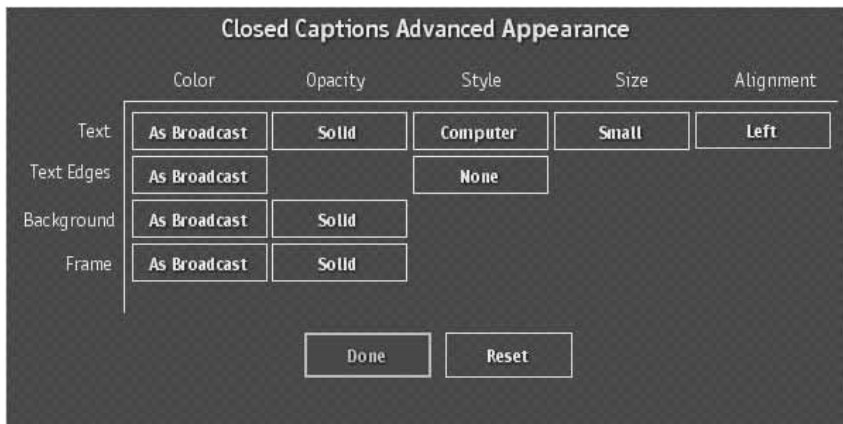

Caption Preference

Select Always Basic/Always Advanced/Automatic.

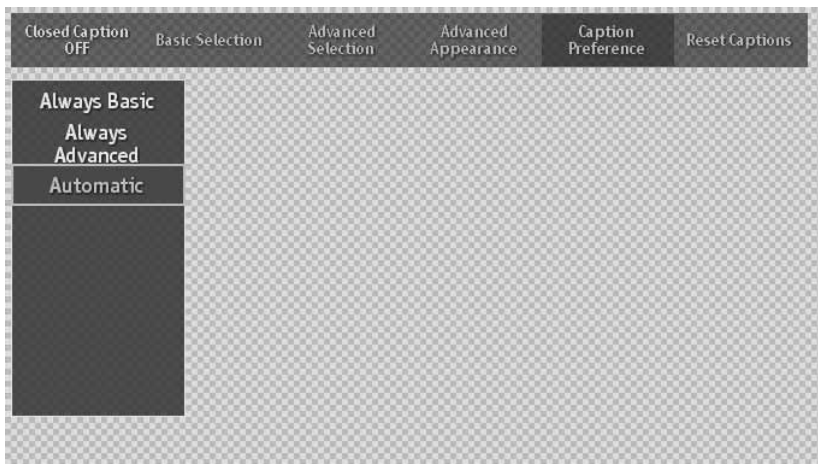

Sleep Timer

Set the sleep timer you want.

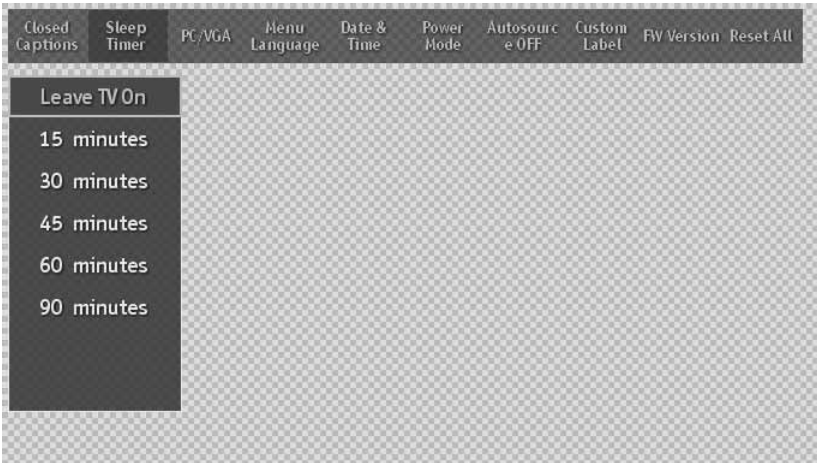

PC/VGA

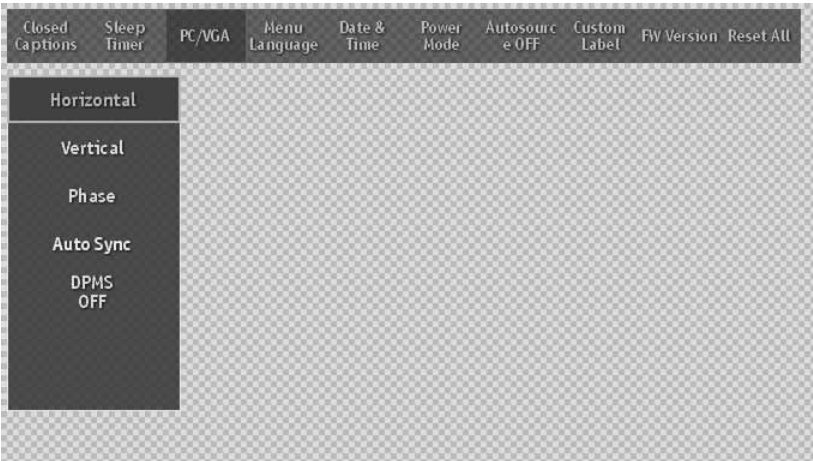

Horizontal, Vertical

Use arrow keys to adjust your picture horizontal or vertical position.

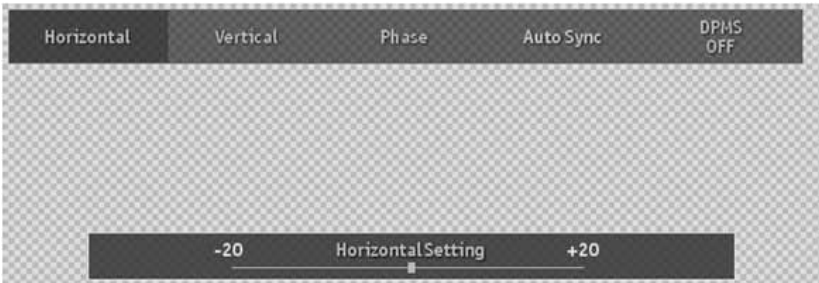

Phase

You can use Phase to adjust your picture phase.



AutoSync

Use to auto adjust your VGA picture.

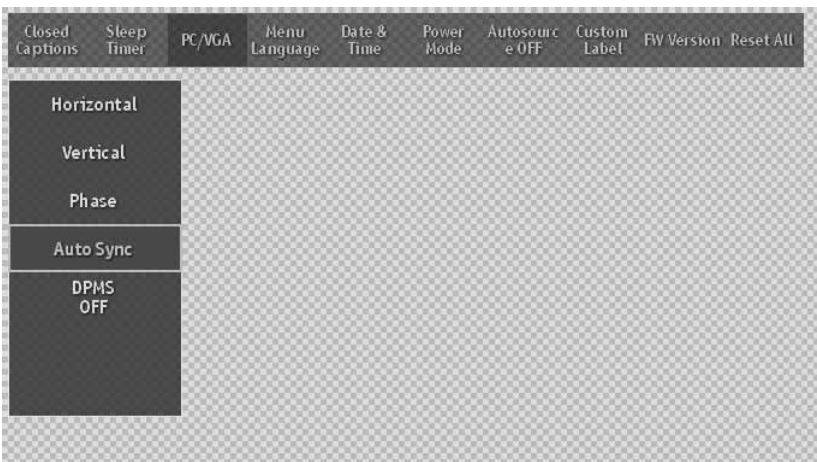

DPMS

Set DPMS ON/OFF.

Menu Language

Use arrow keys to adjust Menu Language



Date & Time

Set Date & Time.

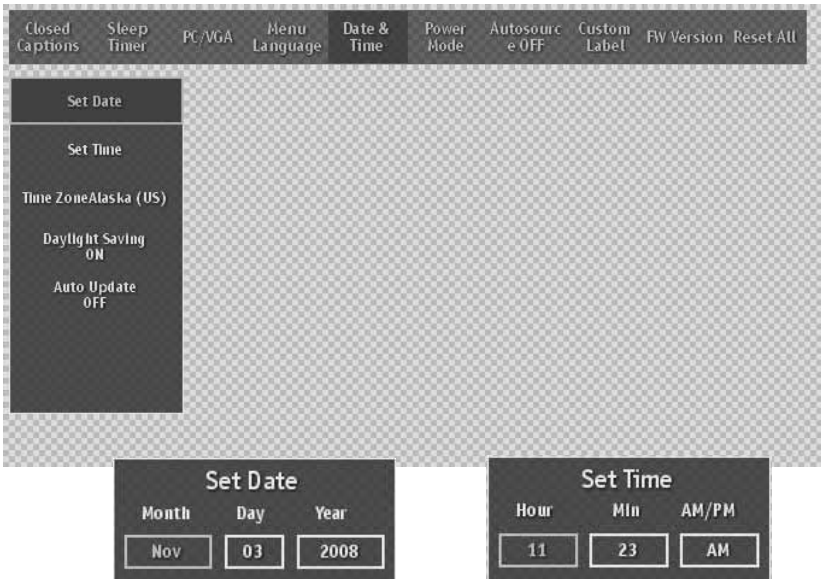

Power Mode

Set TV power modes (Normal = quick boot-up time, but large power consumption; Energy saving = longer boot-up time, but small power consumption.)

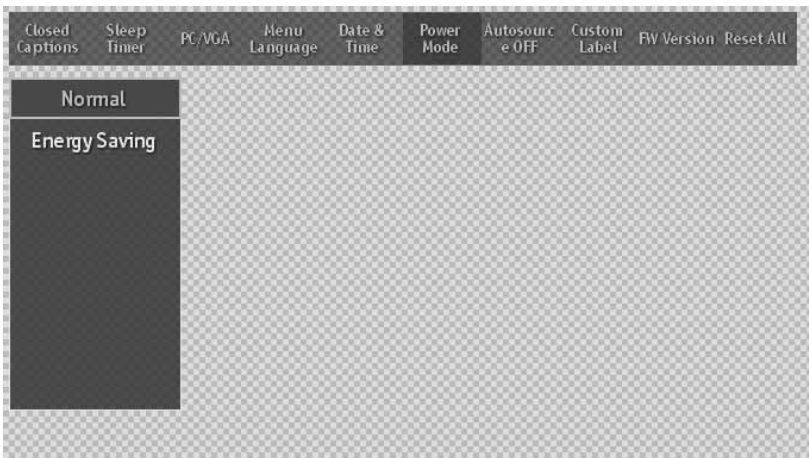

Autosource™

Autosource™ will detect a new incoming signal and automatically switch the input source to the connection of the new source's device.

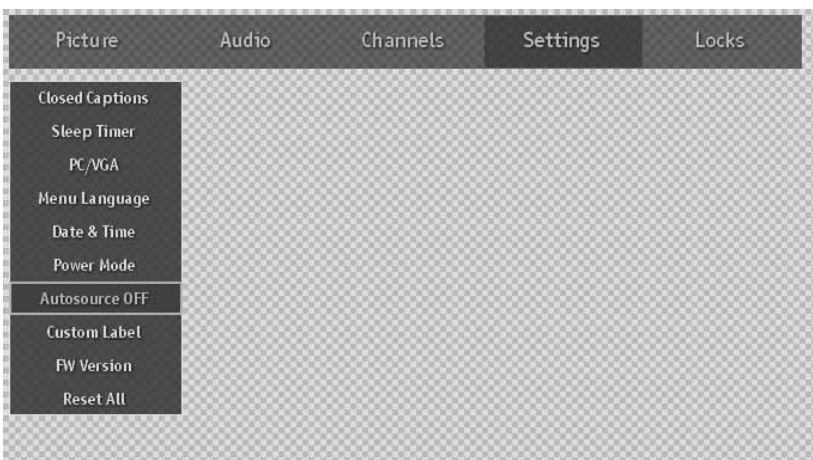

Custom Label

Choose the custom source Label

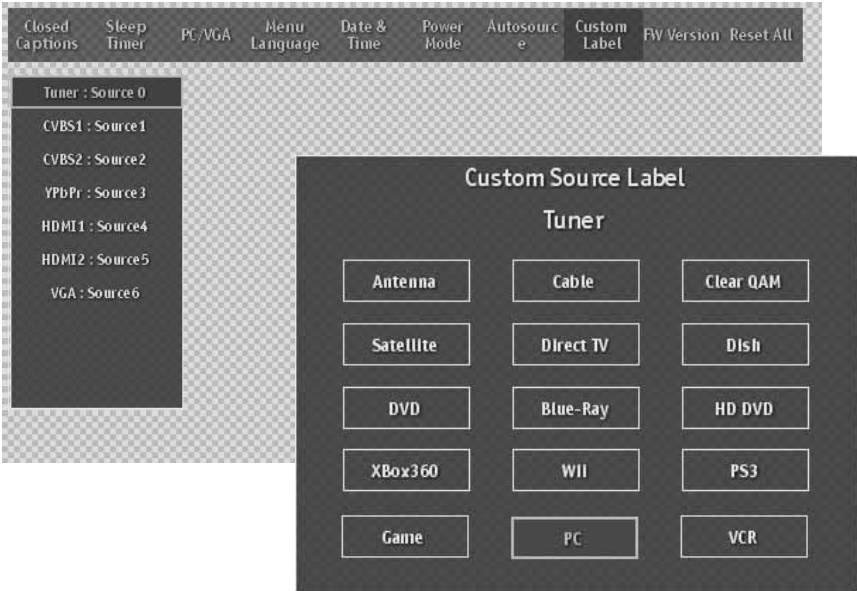

English

Español

Français

FW Version

You can see what Software version your TV has.

RESET ALL

Reset all settings back to factory defaults. Reset will delete all settings you have made including channel list.

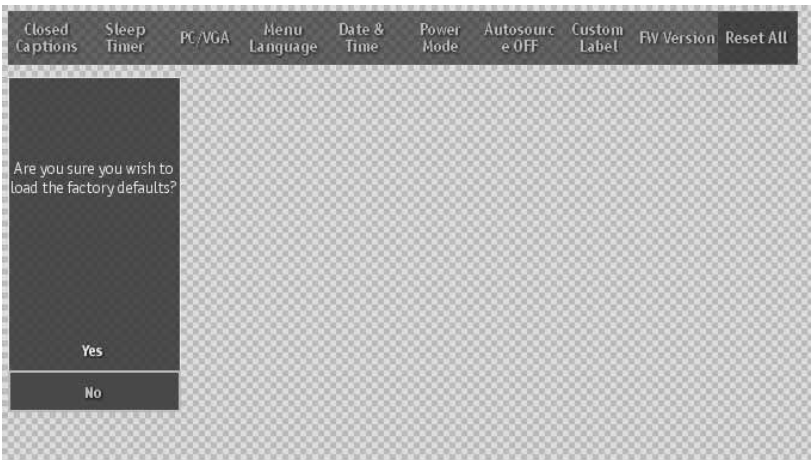

Locks

Lock feature prevents viewers from watching programs that are not age-appropriate, such as programs containing violence or adult language.

The pin number is required when you want to enter Locks menu, just use the remote control to key in your pin number. The factory default pin number is 0000.



Rating Locks

Select what you want to set.

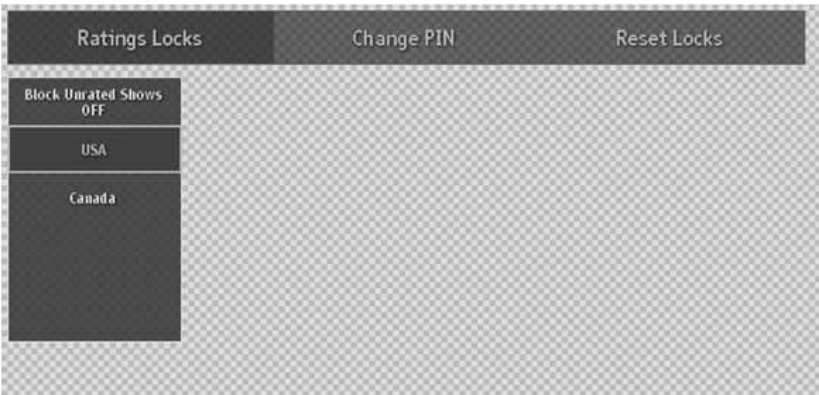

USA TV Rating

- TV Y All children
- TV Y7 For older children
- TV G General audience
- TV PG Parental guidance suggested
- TV 14 Parental strongly cautioned
- TV MA Mature audience only



USA Movie Rating

- G General audience
- PG Parental guidance suggested
- PG-13 Parental strongly cautioned
- R Restricted
- NC 17 No on 17 and under admitted
- X Adult audience only



Canada-French

- G General programming, suitable for all audience
- 8 ans+ Children eight years and older
- 13 ans+ Viewers 13 year and older
- 16 ans+ Viewers 16 year and older
- 18 ans+ Adult programming



Canada-English

- C Children
- C8+ Children eight years and older
- G General programming, suitable for all audience
- PG Parental guidance
- 14+ Viewers 14 year and older
- 18+ Adult programming



TROUBLESHOOTING

There is no picture or sound.

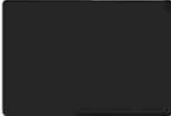

- Make sure the AC adapter is connected.
- Verify that there is a valid source signal.
- Make sure the correct input mode is selected.

There is no picture from AV.



- Make sure the BRIGHTNESS is properly adjusted.
- The florescent lamp may have reached the end of its life. Contact an authorized service center.
- Make sure the video source is plugged into the composite video-in port.

There is no sound.



- Make sure the volume is not set to minimum.
- Make sure the sound is not muted

There is no picture or sound, just noise.



- The source signal may be weak.
- Your provider may be experiencing difficulties.
- Check your input connections.

Picture is not clear.



- The source signal may be weak.
- The provider may be experiencing difficulties.
- Check input connections.

Picture is light or improperly tinted.



- Check the Hue, Saturation and Color adjustments.
- Reset the TV to the factory default settings.

The picture is too dark.



- Select a different Video Preset mode.
- Check the Brightness of Picture Settings.
- The fluorescent lamp may have reached the end of its life. Contact an authorized service center.

Remote control does not work.



- Install new batteries.
- Make sure the remote sensor window isn't blocked.
- Make sure the system is in the right mode (TV / VCR / CBL / AUX)

There are stripes on the screen or colors fade.



- There may be interference from other appliances.
- There may be interference between the video source cable and the power cable.
- Make sure the power and video cables are not touching. Check the Hue, Saturation and Color adjustments

The picture is not sharp.



- The signal source may be weak.
- The provider may be experiencing difficulties.
- Check input connections.
- Check the Sharpness of Picture Settings.

The picture moves.



- The source signal may be weak.
- The provider may be experiencing difficulties.
- Check input connections.

The picture is doubled or tripled.



- The source signal may be weak.
- Check input connections.

The picture is spotted.



- There may be interference from other appliances nearby or around the LCD TV.

PC INPUT PRESET TIMMING TABLE

PC / Timing Table

No.	Mode Name Resolution	H.Freq. V.Fre.	H. Polarity V. Polarity	Pixel CLK (MHz)	Hor. Total CLK No.	Hor. Display CLK No.	Hor. Bck Porch CLK No.	Hor. Syth CLK No.	Vert. Total Line No.	Vert. Display Line No.	Vert. Bak Porch Line No.	Vert. Syc Width Line No.
1	VGA 70Hz 720*400	31.469 70.087	- +	28.322	900	720	54	108	449	400	35	2
2	VGA 60Hz 640*480	31.469 59.941	- -	25.175	800	640	48	96	525	480	33	2
3	VGA 67Hz 640*480	35.00 66.667	- -	30.24	864	640	96	64	525	480	39	3
4	VGA 72Hz 640*480	37.861 72.809	- -	31.5	832	640	120	40	520	480	20	3
5	VGA 75Hz 640*480	37.5 75.0	- -	31.5	840	640	120	64	500	480	16	3
6	SVGA 56Hz 800*600	35.156 56.25	+ +	36.0	1024	800	128	72	625	600	22	2
7	SVGA 60Hz 800*600	37.879 60.317	+ +	40.0	1056	800	88	128	628	600	23	4
8	SVGA 72Hz 800*600	48.077 72.188	+ +	50.0	1040	800	64	120	666	600	23	6
9	SVGA 75Hz 800*600	46.875 75.0	+ +	49.5	1056	800	160	80	625	600	21	3
10	75Hz 832*624	49.72 74.55	- -	57.28	1152	832	224	64	667	624	39	3
11	XGA 60Hz 1024*768	48.363 60.004	- -	65.0	1344	1024	160	136	806	768	29	6
12	XGA 70Hz 1024*768	56.476 70.069	- -	75.0	1328	1024	144	136	806	768	29	6
13	XGA 75Hz 1024*768	60.023 75.029	+ +	78.75	1312	1024	176	96	800	768	28	3
14	60Hz 1280*720	44.76 60.0	- +	74.481	1664	1280	192	136	746	720	22	3
15	60Hz 1280*800	49.68 60.0	- +	83.462	1680	1280	200	136	828	800	24	3
16	60Hz 1280*1024	63.98 60.02	+ +	108.00	1688	1280	248	112	1066	1024	38	3

No.	Mode Name Resolution	H.Freq. V.Fre.	H. Polarity V. Polarity	Pixel CLK (MHz)	Hor. Total CLK No.	Hor. Display CLK No.	Hor. Bck Porch CLK No.	Hor. Syth CLK No.	Vert. Total Line No.	Vert. Display Line No.	Vert. Bak Porch Line No.	Vert. Syc Width Line No.
17	60Hz 1360*768	47.712 60.015	+ +	85.5	1792	1360	256	112	795	768	18	6
18	60Hz 1366*768	48.96 60.0	+ -	73.25	1496	1366	58	32	816	768	41	5

* The resolution and the frequencies are displayed on the screen may not exactly same as this list.

PRODUCT SPECIFICATION

English

Español

Français

ITEMS		26" LCD - TV	
Panel	Screen Size	26" LCD Panel	
	Aspect Ratio	16 : 9	
	Resolution	1366 x 768	
	Display colors	16.2M colors	
	Viewing Angle (CR>10)	170° Hor. / 170° Ver. (typ.)	
TV Function	Broadcasting System	Analog : NTSC M / N	Digital : ATSC/Clear QAM
	Receiving Channel	Analog : PLL181Ch., CATV 125Ch	Digital : 54M Hz~864M Hz
	Sound System	Analog : Multi-channel TV Sound	Digital : Multi-Track Sound
	Resolution	Analog : 480i	Digital : 1080i, 720p,480p, 480i
	Data Broadcasting	Close Caption , V - Chip	
Video Input	Composite Signal	CVBS	x 2
	Component Signal	Y Pb Pr	x 1 (720P / 1080i , HDTV ready)
	HDMI Connection	HDMI	x 2
	VGA Connection	D-Sub 15 pin	x 1
	Scanning Frequency	$f_{H} = 31.5 \sim 60\text{KHz}$ / $f_{V} = 56 \sim 75\text{Hz}$	
Audio Input	Audio 1	Composite	x 2
	Audio 2	Component	x 1
	Audio 3	HDMI to DVI	x 1
	Audio 4	PC jack in	x 1
Audio Output	Speaker (build-in)	10W + 10W (Average)	
	RCA Out	Left / Right	
	Digital Audio Out	SPDIF (DTV) .	
Feature	Function Keys	Menu , +/- (Volume) , Up/Down(Channel), Source, Power	
	Video Performance	3D Comb-filter , 3D De-interlace , Aspect Ratio Control (ARC) , Auto Picture Control, Noise Reduction	
	Other Control	Sleep Timer, Timer On, Timer Off	
Power	Power Supply	AC 100V ~ 240V , 50 / 60Hz (SK-26H540S)	
	Power Consumption	AC 120V , 50 / 60Hz (SK-26H730S) < 200 W	
Wall Mount		For use only UL Listed Wall mount Bracket or F4030 Wall Mount Bracket.	
Dimension	W x H x D	655 mm * 505 mm * 175 mm (SK-26H540S)	
		639 mm * 470 mm * 213 mm (SK-26H730S)	
Weight (net)	Without Accessories	11 Kg (SK-26H540S)	
		9 Kg (SK-26H730S)	



www.wde.com



Westinghouse Digital Electronics
Santa Fe Springs, CA

E030057363

SE-UM-2608-0701

Free Manuals Download Website

<http://myh66.com>

<http://usermanuals.us>

<http://www.somanuals.com>

<http://www.4manuals.cc>

<http://www.manual-lib.com>

<http://www.404manual.com>

<http://www.luxmanual.com>

<http://aubethermostatmanual.com>

Golf course search by state

<http://golfingnear.com>

Email search by domain

<http://emailbydomain.com>

Auto manuals search

<http://auto.somanuals.com>

TV manuals search

<http://tv.somanuals.com>