



USER'S MANUAL
MANUEL DE L'UTILISATEUR
MANUAL DEL USUARIO

UW48T7HW

TABLE OF CONTENTS

TABLE OF CONTENTS.....	i
DIGITAL TELEVISION TRANSITION NOTICE	1
ENERGY STAR DISCLAIMER	1
IMPORTANT INFORMATION.....	2
Warnings	2
NOTICES	3
FCC COMPLIANCE STATEMENT	4
IMPORTANT SAFETY INSTRUCTIONS	5
Circuit Overload.....	6
Power Cord Protection	6
Ventilation.....	6
WARNINGS AND PRECAUTIONS	7
ANTENNA INSTALLATION SAFETY.....	8
Lightning.....	8
Power lines.....	8
CLEANING THE LED TV	9
Dolby License Notice.....	9
Licensing and Patent Information.....	9
PACKAGE CONTENTS.....	10
CONTROL PANEL.....	11
TERMINALS	12
REMOTE CONTROL	13
REMOTE CONTROL OPERATION.....	14
INSTALLING THE REMOTE CONTROL BATTERIES	14
REMOTE CONTROL TRANSMISSION RANGE	14
LED TV BASE.....	15
INSTALLING THE LED TV BASE	15
REMOVING THE LED TV BASE	16
ANTENNA CONNECTION.....	17
OUTDOOR ANTENNA CONNECTION.....	17
CABLE TV (CTV/DTV) CONNECTION	17
EXTERNAL DEVICE CONNECTIONS	18

TABLE OF CONTENTS

POWER CONNECTION 20
 CONNECTING AC POWER..... 20
 INITIAL SETUP 20
 ANTENNA OR COAXIAL CABLE CONNECTION SETUP 21
 CABLE OR SATELLITE BOX CONNECTION SETUP 24
 OTHER INPUT SOURCE CONNECTION SETUP 26
 WESTINGHOUSE HDTV SETUP - NOT THROUGH CABLE/
 SATELLITE BOX..... 28
BASIC OPERATIONS..... 30
 TURNING THE POWER ON AND OFF 30
 ADJUSTING THE VOLUME..... 30
 CHANGING CHANNELS 31
 SELECTING THE INPUT SOURCE..... 31
 ADJUSTING THE DISPLAY FORMAT 32
SETUP MENUS 33
 SETUP MENU OPERATION..... 33
 PICTURE..... 34
 SOUND 41
 CHANNEL 45
 PARENTAL CONTROL..... 48
 SETUP 53
 CHANNEL..... 53
WALL MOUNT OPTION 57
 WALL MOUNT INSTALLATION REMINDERS 57
TROUBLESHOOTING..... 58
SPECIFICATIONS 61

English

DIGITAL TELEVISION TRANSITION NOTICE

This device contains a digital television tuner, so it should receive digital over the air TV programming, with a suitable antenna, after the end of full-power analog TV broadcasting in the United States on June 12, 2009. The nationwide switch to digital television broadcasting will be complete on June 12, 2009, but your local television stations may switch sooner. After the switch, analog-only television sets that receive TV programming through an antenna will need a converter box to continue to receive over-the-air TV. Watch your local stations to find out when they will turn off their analog signal and switch to digital-only broadcasting.

For more information, call the FCC at 1-888-CALL-FCC (1-888-225-5322) or see www.DTV.gov. For information on the TV Converter program, and on government coupons that may be used toward the purchase of one, see www.dtv2009.gov, or call the NTIA at 1-888-DTV-2009.

ENERGY STAR DISCLAIMER

This Westinghouse product has earned the ENERGY STAR® for meeting U.S. Federal energy efficiency guidelines as set by the Department of Energy and Environmental Protection agency. The ENERGY STAR® program exists to provide energy saving guidelines and help promote energy efficient products and practices. Changes to certain features, settings and functions of this TV can change and/or increase its power consumption. Depending on how settings are changed, power consumption may exceed the limits required for ENERGY STAR® qualification. This Westinghouse TV will operate at optimal energy efficiency in “Home” mode.

IMPORTANT INFORMATION

Warnings

To reduce the risk of fire or electric shock:

- Do not expose this product to rain or moisture.
- Do not remove the rear cover. There are no user-serviceable parts inside. Refer all servicing requirements to qualified service personnel.
- The plug should be connected to a mains socket outlet with a protective earthing connection.



The lightning flash with arrowhead inside an equilateral triangle symbol is intended to alert the user to the presence of uninsulated dangerous voltage within the product's enclosure that may be of sufficient magnitude to constitute a risk of electric shock.



The exclamation inside an equilateral triangle symbol is intended to alert the user to related operating and maintenance instructions in the user documentation accompanying the product.

WARNING!

This device must be operated with the original power supply.

WARNING!

To prevent injury, this apparatus must be securely attached to the floor/wall in accordance with the installation instructions.

CAUTION:

The power supply outlet should be located near the LED TV and should be easily accessible.

Always use the appropriate AC cord that is certified for your specific country. Some examples are listed below:

- USA – UL
- Canada – CSA
- Japan – Electric Appliance Control Act

NOTICES

Important Notices Concerning Power Cord Selection

The specific power cord for this LED TV is enclosed and has been selected according to the country of destination. Use the enclosed power cord to prevent electric shock. Observe the following guidelines if it is necessary to replace the original cord set, or if there is no cord set enclosed. The female receptacle of the cord set must meet IEC-60320 requirements and should look like Figure A1 below:

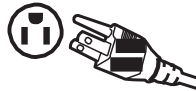

Figure A2

For the United States and Canada

In the United States and Canada the male plug is a NEMA5-15 style (Figure A2), UL-listed, and CSA-labeled. For LED TVs that are to be placed on a desk or table, type SVT or SJT cord sets may be used. For LED TVs that are to be placed directly on the floor, only SJT type cord sets may be used. The cord set must be selected according to the current rating for the LED TV. Consult the table below for the selection criteria of power cords used in the United States and Canada.

Cord Type	Size of Conductor in Cord	Maximum Unit Current Rating
SJT	18 AWG	10 Amps
	16 AWG	12 Amps
	14 AWG	12 Amps
SVT	18 AWG	10 Amps
	17 AWG	12 Amps

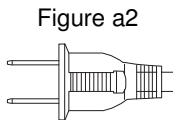
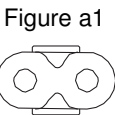

Figure a2-1

Detachable, Max. 4.5 m long, Min. 1.5 m long, Type SVT, SJT or SPT-2, No. 18 AWG/2C. One end terminates in NEMA 1-15P with min. 125 V ac, 2.0 A min., or NEMA 2-15P with min. 250 V ac, 2.0 A min., the other end with an appliance coupler.

FCC COMPLIANCE STATEMENT

This equipment has been tested and complies with the limits for a Class B digital device, pursuant to part 15 of the FCC Rules. These limits are designed to provide reasonable protection against harmful interference in a residential installation. This equipment generates, uses, and can radiate radio frequency energy, and may cause harmful interference to radio communications if not installed and used in accordance with the instructions. However, there is no guarantee that interference will not occur in a particular installation. If this equipment does cause harmful interference to radio or television reception, which can be determined by turning the equipment off and on, the user is encouraged to try to correct the interference by one or more of the following measures:

- Reorient or relocate the receiving antenna.
- Increase the distance between the LED TV and the receiver.
- Connect the LED TV to an outlet on a circuit separate from to which the receiver is connected.
- If the interference persists even after performing the above measures, consult the Westinghouse Service Center or an experienced radio/TV technician for assistance.

FCC Warning

To assure continued FCC compliance, use a grounded power supply cord and the provided shielded video interface cable with bonded ferrite cores. If a BNC cable is used, use only a shielded BNC (5) cable. Also, any unauthorized changes or modifications not expressly approved by the manufacturer will void the user's authority to operate this device.

IMPORTANT SAFETY INSTRUCTIONS

Make sure to note and follow all warnings and instructions marked on the LED TV. Observe the following safety instructions.

- Read these instructions.
- Keep these instructions.
- Read all warnings.
- Follow all instructions.
- Do not use this apparatus near water.
- Clean only with dry cloth.
- Do not block any ventilation openings. Install in accordance with the manufacturer's instructions.
- Do not install near any heat sources such as radiators, heat registers, stoves, or other apparatus (including amplifiers) that produce heat.
- Do not defeat the safety purpose of the polarized or grounding-type plug. A polarized plug has two blades with one wider than the other. A grounding type plug has two blades and a third grounding prong. The wide blade or the third prong are provided for your safety. If the provided plug does not fit into your outlet, consult an electrician for replacement of the obsolete outlet.
- Protect the power cord from being walked on or pinched particularly at plugs, convenience receptacles, and the point where they exit from the apparatus.
- Only use attachments/accessories specified by the manufacturer.
- Use only with the cart, stand, tripod, bracket, or table specified by the manufacturer, or sold with the apparatus. When a cart is used, use caution when moving the cart/apparatus combination to avoid injury from tip-over.



- Unplug this apparatus during lightning storms or when unused for long periods of time.
- Refer all servicing to qualified service personnel. Servicing is required when the apparatus has been damaged in any way, such as power-supply cord or plug is damaged, liquid has been spilled or objects have fallen into the apparatus, the apparatus has been exposed to rain or moisture, does not operate normally, or has been dropped.

IMPORTANT INFORMATION

Circuit Overload

Do not overload wall outlets, extension cords, or power strips. This can result in a fire or electronic shock.

Power Cord Protection

Power supply cords should be routed so that they are not likely to be walked on or pinched by items placed upon or against them. Periodically inspect the cords for damage. Install the LED TV near a wall socket outlet where the power cord can be readily accessed.

Ventilation

The slots and openings on the cabinet are provided for necessary ventilation. To ensure reliable operation of the LED TV and to protect it from overheating, these slots and openings must never be blocked or covered.

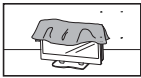

Never cover the slots and openings with a cloth or other materials.

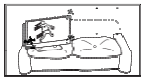

Do not block the openings by placing the LED TV on a bed, sofa, rug or other similar surface.



Do not place the LED TV in a built-in installation such as a bookcase or a rack unless proper ventilation is provided or the manufacturer's instructions have been adhered to.

WARNINGS AND PRECAUTIONS

- Do not orient the LED TV towards direct sunlight to reduce glare.
- If the LED TV will not be used for a long period of time, unplug the unit and remove the batteries from the remote control.
- Avoid touching the display screen by hand or any object.
- Never remove the rear cover. The LED TV interior contains high-voltage parts. You may be seriously injured if you touch them.
- Always handle the LED TV with caution when moving it.
- Do not install the LED TV in airtight compartments, or in areas where it can be exposed to water or high temperature.
- Ensure that the area around the LED TV is clean and free of moisture.
- Do not place anything on the LED TV that can hinder heat dissipation.
- Do not place naked flame sources, such as lighted candles, on or near the LED TV.
- Do not place anything on the LED TV that can cause liquid to splash on it (e.g. flower vase).
- Do not place heavy objects on the LED TV, audio/video cables, or power cord.
- If the LED TV emits smoke, abnormal noise, or a strange odor, immediately turn it off and contact the Westinghouse Service Center by:
 - Logging on to www.wde.com.
 - Contacting the Westinghouse Customer Service at (800) 701-0680.
 - E-mailing us at service@wde.com.

ANTENNA INSTALLATION SAFETY

Outdoor Antenna Grounding

If an outside antenna or cable system is connected to the LED TV, be sure the antenna or cable system is grounded to prevent voltage surges and built-up static charges. Article 810 of the National Electrical Code, ANS/NFPA 70, provides information on proper grounding of the mast and supporting structure, grounding of the lead-in wire to an antenna discharge unit, connection to grounding electrodes, and requirements for the grounding electrode.

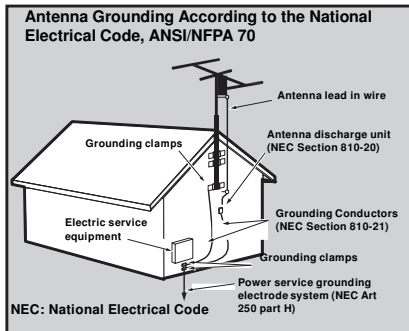

Lightning

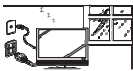

For added protection for the LED TV during a lightning storm, or when it is left unattended and unused for long periods of time, unplug it from the wall outlet and disconnect the antenna or cable system. **DO NOT** disconnect the antenna or the power cord during a heavy storm—lightning may strike while you are holding the cable cord, causing serious injury. Turn off the LED TV and wait for the weather to improve.

Power lines



An outside antenna system should not be located in the vicinity of overhead power lines or other electric light or power circuits, or where it can fall into such power lines or circuits. When installing an outside antenna system, extreme care should be taken to keep from touching such power lines or circuits as contact with them might be fatal.

CLEANING THE LED TV

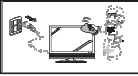

- Make sure the LED TV is turned off and the power cord is disconnected from the power outlet.
- Never spray or pour any liquid directly onto the screen or the case.

To clean the screen:

- 1 Wipe the screen with a clean, soft, lint-free cloth. This removes dust and other particles.
- 2 If it is still not clean, apply a small amount of non-ammonia, non-alcohol based glass cleaner onto a clean, soft, lint-free cloth, and wipe the screen.

To clean the case:

- 1 Wipe the case with a soft, dry cloth.
- 2 If it is still not clean, apply a small amount of non-ammonia, non-alcohol based, mild non-abrasive detergent onto a clean, soft, lint-free cloth, then wipe the surface.

Dolby License Notice











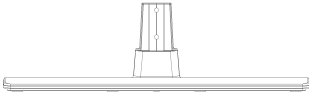

Manufactured under license from Dolby Laboratories. Dolby and the double-D symbol are registered trademarks of Dolby Laboratories.

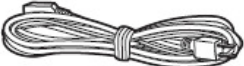
Licensing and Patent Information

This WESTINGHOUSE product may be covered by one or more U.S. and foreign patents and patent applications. See <http://westinghousedigital.com/compliance/> for details.

PACKAGE CONTENTS

<p>48" LED TV Unit</p>	<p>Remote Control (with 2x AAA batteries)</p>
	
<p>LED TV Base</p>	<p>User Manual</p>
	
<p>Power Cord</p>	<p>Warranty Card</p>
	
<p>AC Adapter</p>	<p>Quick Connect Guide</p>
	
<p>Screws for Base</p>	<p>Screw for Base</p>
<p>M4 x30 * 2pcs</p>  <p>Cover neck</p>	<p>M5x16 *1pc</p>  <p>Base</p>

CONTROL PANEL

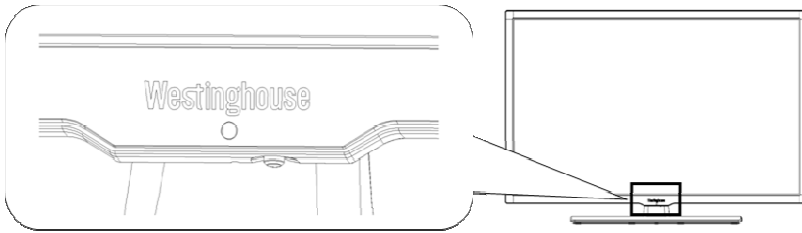

Item	Description
1. Power	Toggles the power on and off.

TERMINALS

NO.	Description
1	DC IN
2	COAX OUT
3	HDMI1
4	VGA & YPbPr IN
5	PC & YPbPr AUDIO IN
6	RF IN
7	CVBS IN
8	CVBS RIN
9	CVBS LIN
10	LINE OUT
11	HDMI2
12	USB IN

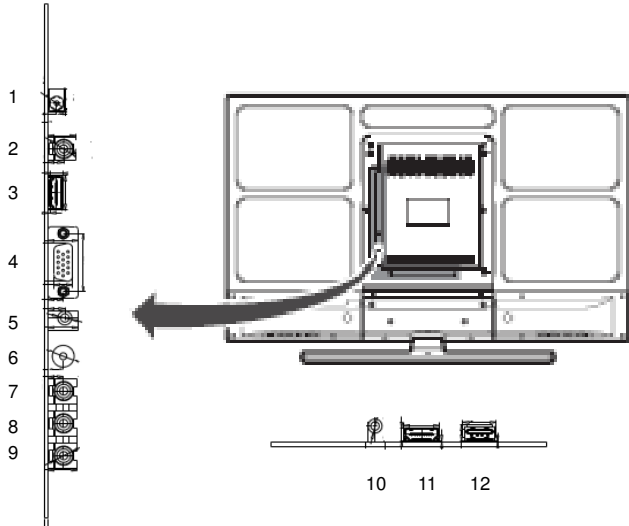

Item	Function
1. DC IN	Connects the AC to DC adapter from this outlet to a power source
2. COAX OUT	Connects to an external analog audio receiver
3. HDMI1/2	Connects to an external AV device such as a VCR, DVD player, set-top box, or game system.
4. VGA & Ypbpr IN	Connects to a computer or other device with a VGA or Ypbpr output using a 15-pin VGA cable.
5. PC & Ypbpr AUDIO IN	Connects to the audio out port of a computer or other device.
6. TV Tuner	Connects the LED TV to an antenna or cable service.
7. USB	For service only.
8. AV	Connect to an external AV device such as a VCR, DVD player, set-top box, or game system.
9. LINE OUT	Connect to an analog audio output device.

REMOTE CONTROL

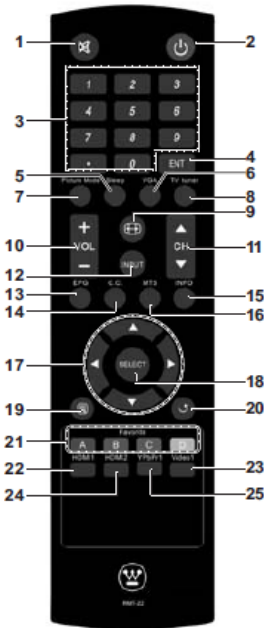

Item	Description
1. Mute	Mutes the sound. Press again to toggle the sound back on.
2. Power	Toggles the TV power on or off.
3. Channel keys	Use to key in the channel number.
4. Enter <i>ENT</i>	Executes a channel entry.
5. Sleep	Sets the sleep timer for the LED TV to turn off automatically.
6. VGA	Switches to the VGA input source.
7. Picture Mode	Selects a preset viewing options.
8. TV tuner	Switches to the TV input source.
9. Aspect ratio	Selects the video display format.
10. VOL +/-	Adjusts the system volume.
11. CH ▲ / ▼	Switches to other TV channels.
12. INPUT	Selects the video input source.
13. EPG	Displays the Electronic Program Guide (EPG). It contains the program information for the channel you're watching.
14. CC	Toggles the closed caption display on or off.
15. Info	Displays the input source or channel information as well as the system time.
16. MTS	Toggles the Multichannel Television Sound options.
17. Arrow keys	Navigate through the on-screen menus.
18. SELECT	Confirms the selection.
19. Menu	Accesses the LED TV setup menus.
20. Return	Switches to the last selected channel.
21. Favorite	Switches to the favorite channels (for details on how to save a new favorite channel, see page 28).
22. HDMI1	Selects HDMI1 as the input source.
23. Video1	Selects the Composite AV device as the input source.
24. HDMI2	Selects HDMI2 as the input source.
25. YPbPr1	Selects VGA-Component as the input source.

REMOTE CONTROL OPERATION

INSTALLING THE REMOTE CONTROL BATTERIES

CAUTIONS:

- Only use AAA batteries.
- Do not mix new and old batteries. This may result in cracking or leakage, which may pose a fire risk or lead to personal injury.
- Insert batteries according to the (+) and (-) markings. Inserting the batteries incorrectly may result in cracking or leakage, which may pose a risk of fire or lead to physical injury.
- Dispose of used batteries in accordance with local laws and regulations.
- Keep batteries away from children and pets.
- When the remote control will not to be used for an extended period, remove the batteries.

- 1 Remove the battery cover.
- 2 Insert the batteries. Make sure the (+) and (-) marks on the batteries match those inside the compartment.
- 3 Re-attach the battery cover.

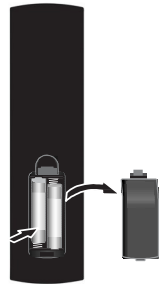

REMOTE CONTROL TRANSMISSION RANGE

Transmission range depends upon the reception angle.
The range of coverage is 20° horizontal/vertical at a distance of 10 feet from the LED TV.

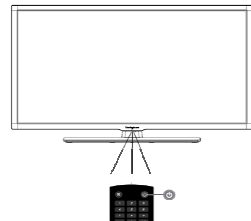

LED TV BASE

CAUTION:

The LED TV unit may be too heavy for one person to lift. If this is the case, make sure to ask for assistance in handling the LED TV to prevent physical injury and/or damage to the unit.

INSTALLING THE LED TV BASE

- 1 Open the LED TV carton box.
- 2 Remove the LED TV base.
- 3 Remove the plastic bag.
- 4 Remove the two top carton stabilizers from the LED TV.
- 5 Remove the protective plastic covering the LED TV.
- 6 Grasp the two sides of the LED TV and then pull it out of the carton box.
- 7 Remove the two bottom carton stabilizers from the LED TV.
- 8 Lay the LED TV on a clear, flat, and stable surface.
- 9 Align the base to the bottom side of the LED TV and use two M4*30 screws to secure it.

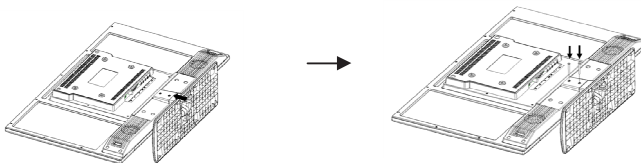

- 10 Carefully orient the LED TV in an upright position.



- 11 Use one M5 x 16 screw to fix the stand base and LED TV on the desk.
Be sure to place the TV at a location (at least 75cm high)

REMOVING THE LED TV BASE

If you intend to repack the LED TV unit (for shipping or storage) or you want to change the installation to a wall mount option, you must first remove the LED TV base.

- 1 Turn off the LED TV and all connected devices.
- 2 Disconnect the power cord from the LED TV.
- 3 Disconnect all signal cables from the I/O port terminals.
- 4 Remove the M5 x 16 screw securing the base to the desk.
- 5 Lay the LED TV on a clear, flat, and stable surface.

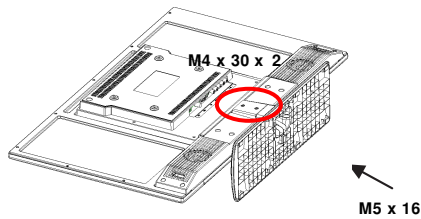

- 6 Remove the two M4*30 screws securing the base to the LED TV.

13. Detach the base from LED TV.

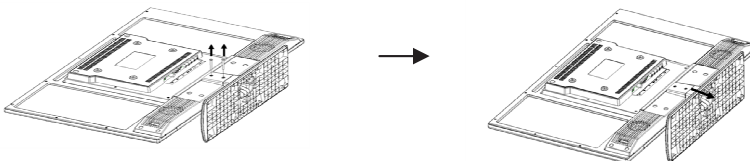

13. Pack the screws you removed in step 5 together with the LED TV base for future reassembly.

ANTENNA CONNECTION

OUTDOOR ANTENNA CONNECTION

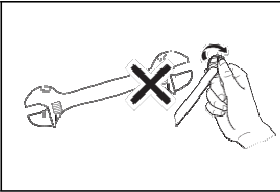
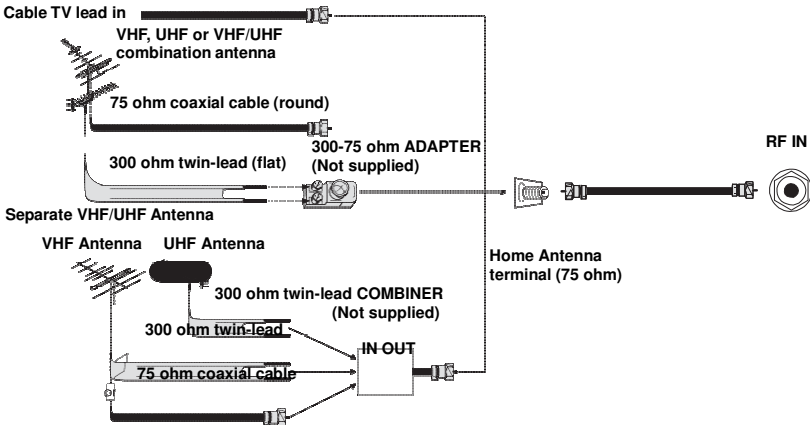

NOTE:

The F-type connector should be finger-tightened only. When connecting the RF cable to the LED TV, do not tighten F-type connector with any tool. If tools are used, it may cause damage to the LED TV (e.g. breaking of internal circuit).

CABLE TV (CTV/DTV) CONNECTION

The unit has a TV tuner (75 ohm coaxial cable connector) located on the rear I/O panel for easy cable hookup. When connecting the 75 ohm coaxial cable to the unit, screw the 75 ohm cable to the TV tuner. Some cable TV companies offer premium pay channels. Since the signals of these channels are scrambled, a cable TV converter/descrambler is usually provided to the subscriber by the cable TV company. This converter/descrambler is necessary for normal viewing of the scrambled channels. (Set your TV to channel 3 or 4. Typically one of these channels is used. If a channel is unknown, consult your cable TV company.) For more specific instructions on installing cable TV, consult your cable TV company. One possible method of utilizing the converter/descrambler provided by your cable TV company is explained below.

EXTERNAL DEVICE CONNECTIONS

- A position on the RF switch (not supplied) – You can view all unscrambled channels by using the TV's channel keys.
- B position on the RF switch (not supplied) – You can view the scrambled channels via the converter/descrambler by using the converter's channel keys.

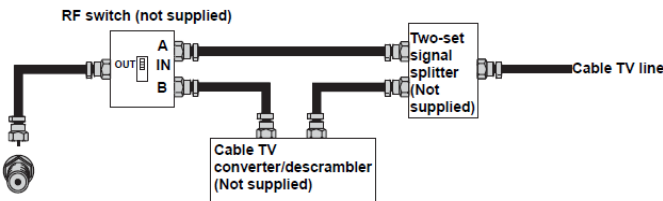

EXTERNAL DEVICE CONNECTIONS

IMPORTANT:

- Turn off the LED TV first before connecting an external device to prevent any possible damage or physical injury.
- For more information about external device connections, see the operation manual of the external device you wish to connect to the LED TV.
- Make sure that the correct cables are connected to each terminal. Improper cable connections may cause damage to the LED TV.

You can enjoy picture and sound by connecting various audio-video devices to the terminals located on the rear and side I/O panels of the LED TV.

- TV cable input – You can use a commercially available audio/video cable.
- Component (YpbPr) input – Picture can be displayed only when a 480i, 480P, 720P, 1080i, or 1080P signal is received.
- HDMI input – Picture can be displayed only when a 480i, 480P, 720P, 1080i, or 1080P signal is received. When you connect to the HDMI terminal with a DVI-HDMI conversion cable, there is a possibility that the picture may not display correctly.
- Audio output – You can output audio signals from the LED TV set through the analog audio out and SPDIF terminals.

The following diagram shows the external device connections.

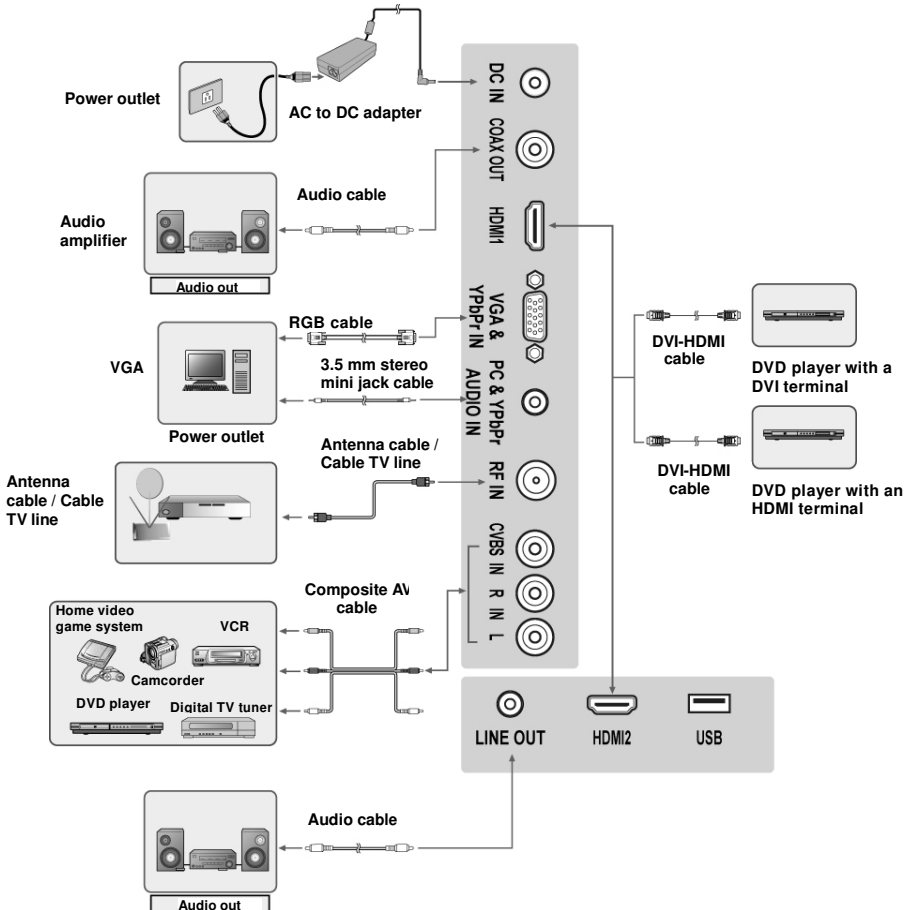

POWER CONNECTION

CONNECTING AC POWER

IMPORTANT:

The LED TV is designed to be powered via an AC adapter. Use **ONLY** the AC adapter included in the package. Turn off all connected devices before plugging the AC adapter into the power outlet.

Connect the power cord of the AC adapter to the LED TV then to a proper AC outlet.

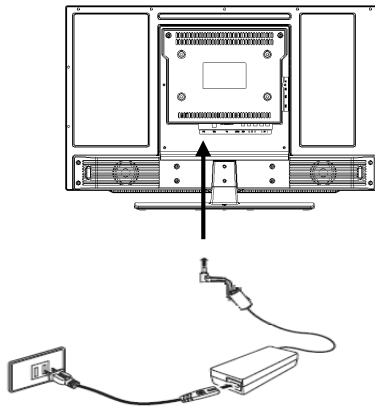

INITIAL SETUP

Press  on the control panel or on the remote control to turn on the LED TV. Select the desired language and select **Yes** to use the SetupWizard. The SetupWizard will guide you on how to set up the LED TV's operational settings.

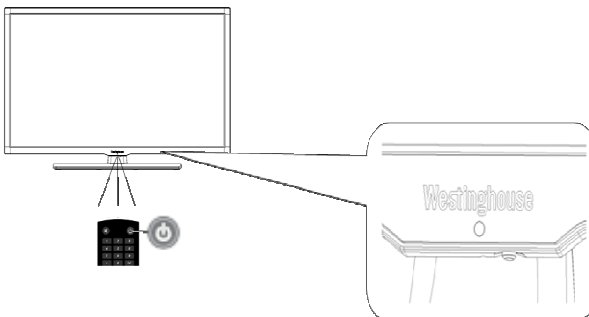

ANTENNA OR COAXIAL CABLE CONNECTION SETUP

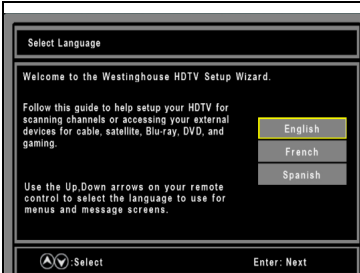

Select Language

Use remote control to select the language to be used for menus and messages. Press **SELECT** to continue.



Time Zone

Use remote control to select your local time zone. Select "Next" and then press **SELECT** to continue. Press Go Back to return to the previous screen.

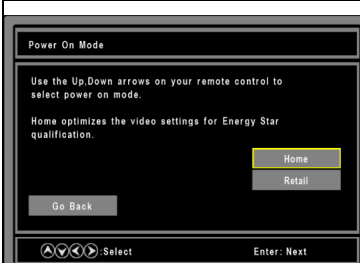

Power On Mode

Use remote control to select the power on mode. Select "Home" and then press **SELECT** to continue. Press Go Back to return to the previous screen.

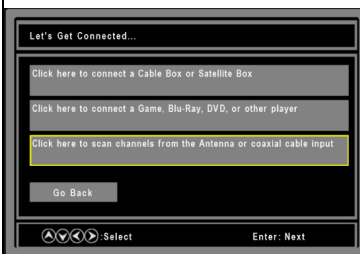

Let's Get Connected

Select "Antenna or coaxial cable input" and press **SELECT** on your remote control to start scanning channels. Press Go Back to return to the previous screen.

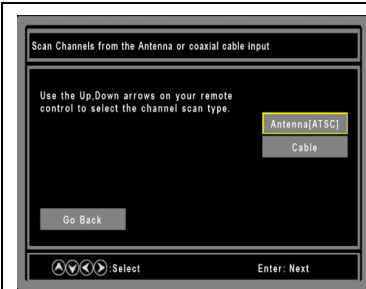

Select Channel Scan Type

Use remote control to select the channel scan type. Press **SELECT** to continue. Press Go Back to return to the previous screen.

NOTE: Antenna users selecting to scan Over-the-Air ATSC channels need a Channel Access Code in order to perform a channel scan and receive broadcast signals.

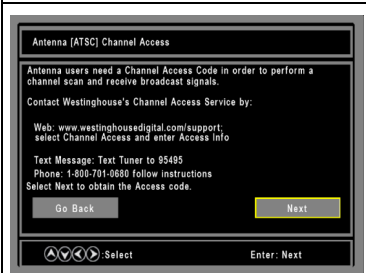

For Antenna [ATSC] only: Antenna [ATSC] Channel Access

Select "Next" and then press **SELECT** to continue. Press Go Back to return to the previous screen.

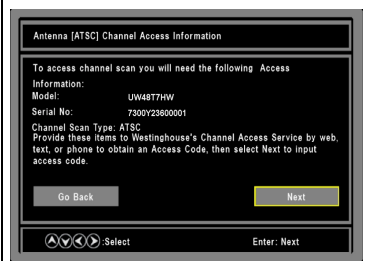

Antenna Channel Access Information

Take note of the channel access information. Select "Next" and then press **SELECT** to continue. Press Go Back to return to the previous screen.



Enter Channel Access Code



Use the number keys on the remote control to enter the channel access code. Press **SELECT** to continue. Press Go Back to return to the previous screen.



Channel Scan in progress

The channel scan may take a while to complete. When the scan is complete, you will be able to watch your local TV programming.

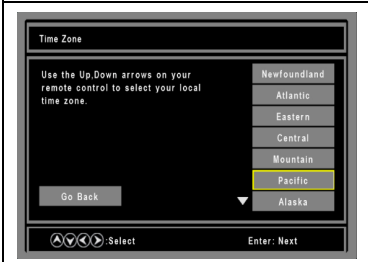
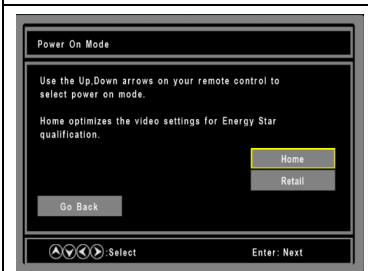
CABLE OR SATELLITE BOX CONNECTION SETUP

	<p>Select Language</p> <p>Use remote control to select the language to be used for menus and messages. Press SELECT to continue.</p>
	<p>Time Zone</p> <p>Use remote control to select your local time zone. Press SELECT to continue. Press Go Back to return to the previous screen.</p>
	<p>Power On Mode</p> <p>Use remote control to select the power on mode. Press SELECT to continue. Press Go Back to return to the previous screen.</p>
	<p>Channel Scan – Cable/Satellite Box</p> <p>Select “Click here to connect a Cable Box or Satellite Box.” And press SELECT on your remote control to start scanning channels. Press SELECT to continue. Press Go Back to return to the previous screen.</p>

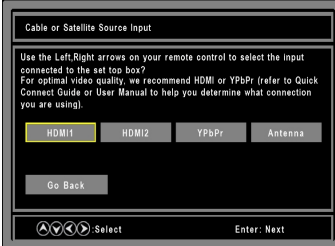
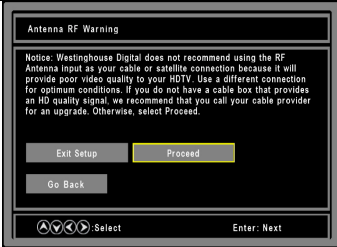
	<p>Cable/Satellite Box Input</p> <p>Use remote control to select the input connected to the set top box. Press SELECT to continue. Press Go Back to return to the previous screen.</p>
	<p>RF Warning</p> <p>Use the up and down arrows on your HDTV control panel or remote control to select. Select "Proceed" and then press SELECT to search the program. Press Go Back to return to the previous screen.</p>

OTHER INPUT SOURCE CONNECTION SETUP

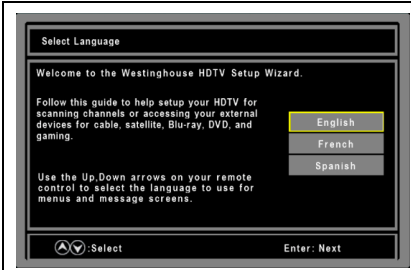

Select Language

Use remote control to select the language to be used for menus and messages. Press **SELECT** to continue.

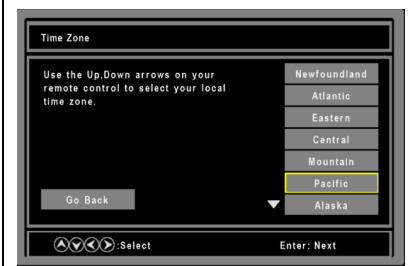

Time Zone

Use remote control to select your local time zone. Press **SELECT** to continue. Press Go Back to return to the previous screen.



Power On Mode

Use remote control to select the power on mode. Press **SELECT** to continue. Press Go Back to return to the previous screen.

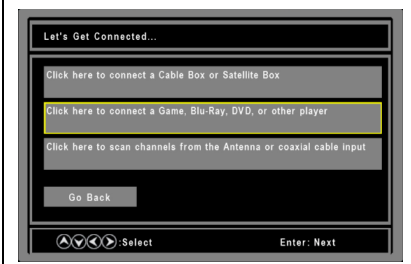

Let's Get Connected

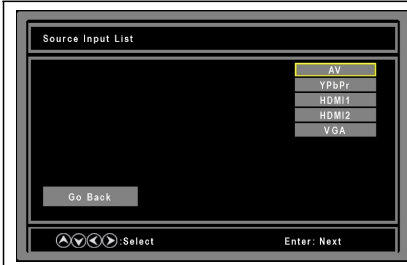

Select "Click here to connect a Game, Blu-Ray, DVD, or other player." And press **SELECT** on your remote control. Press **SELECT** to continue. Press Go Back to return to the previous screen.



Select Input Source

Use remote control to select the input source. Press **SELECT** to continue. Press Go Back to return to the previous screen.

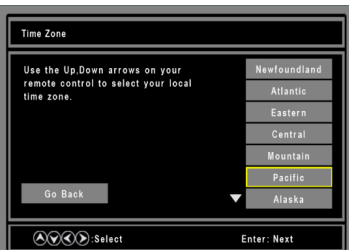
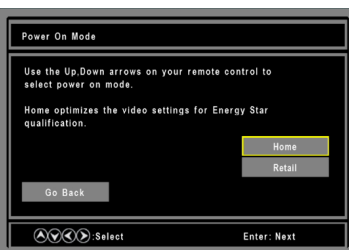
WESTINGHOUSE HDTV SETUP – NOT THROUGH CABLE/ SATELLITE BOX

	<p>Select Language</p> <p>Use remote control to select the language to be used for menus and messages. Press SELECT to continue.</p>
	<p>Time Zone</p> <p>Use remote control to select your local time zone. Press SELECT to continue. Press Go Back to return to the previous screen.</p>
	<p>Power On Mode</p> <p>Use remote control to select the power on mode. Press SELECT to continue. Press Go Back to return to the previous screen.</p>
	

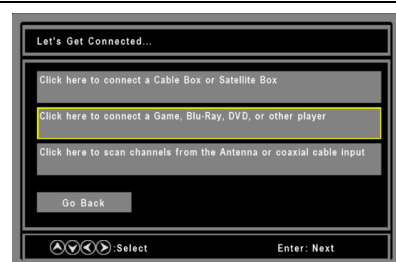

Let's Get Connected

Select "Click here to connect a Game, Blu-Ray, DVD, or other player." And press **SELECT** on your remote control. Press **SELECT** to continue. Press Go Back to return to the previous screen.



Select Input Source

Use the ▲ / ▼ keys on your remote control to select the input source. Press **SELECT** to continue.

BASIC OPERATIONS

TURNING THE POWER ON AND OFF

Turning on the power

Press  on the control panel or on the remote control to turn on the LED TV.

Turning off the power

Press  on the control panel or on the remote control to turn off the LED TV. The LED behavior will depend on the enabled Power settings.

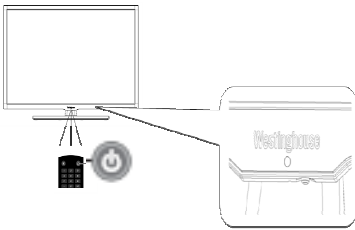

LED indicator	Operation
Turns from none to red.	Turn the power on.
Turns from red to none.	Turn the power off.

NOTES:

- If you are not going to use the TV for a long time, be sure to disconnect the power cord from the wall outlet and remove the batteries from the remote control.
- In standby mode, a small amount of electricity is still consumed even when the power is turned off.

ADJUSTING THE VOLUME

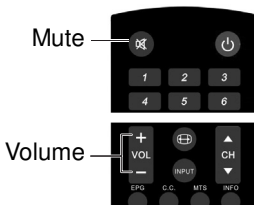

Volume

Press **Vol+** to increase the volume; press **Vol-** to decrease the volume.

Mute

Press  to turn off the sound. The mute icon appears on the screen. Press again to turn on the sound.

CHANGING CHANNELS

Follow the instructions below to change channels.

Using the Ch ▲ / ▼ Buttons

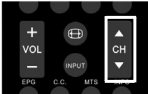

Browse channels

To browse through the available channels, press **Ch▲ / ▼** on the remote control or on the control panel.

Using the Channel Keys



Selecting channel

To change to a certain channel, key in the channel number using the channel keys and press **ENT**.

Selecting digital channel

To select a digital channel, key in the digital channel number using the channel keys and the • key, then press **ENT**.

Using the Favorite Keys



Selecting favorite channels

To select a favorite channel, press the **Favorite** button (A, B, C, or D) corresponding to the preferred channel.

Saving a channel as a favorite

- 1 Switch to the channel you want to add as a favorite.
- 2 Press and hold the **Favorite** button which you want to add the current channel to for 3 seconds.
- 3 The Channel Saved message appears to confirm the new favorite channel item.

SELECTING THE INPUT SOURCE

There are two ways to select the video input source.

Using the Individual Input Keys



TV, VGA, Video, YpbPr, HDMI Keys

Press any of the following remote control keys to change the input source: **TV, VGA, Video1, YpbPr1, HDMI1, or HDMI2**.

Using the Input Key

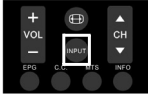

Select source using Input Key

- 1 Press **Input**.
- 2 A list of supported video sources is displayed.
- 3 Press **◀ / ▶** to select the preferred source.
- 4 Press **↔** to switch to the selected input source.

ADJUSTING THE DISPLAY FORMAT

The input source can sometimes affect the way images are displayed on-screen. You can adjust the display format to view the image properly.

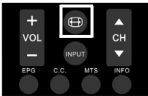

Format Options

Press **⊞** repeatedly to toggle the display format. As you toggle each option on, the actual display will change accordingly. The available options are:

- **Standard:** Picture is displayed in its original size.
- **Fill:** Picture is displayed to cover the entire screen.
- **Overscan:** Picture is scaled up to fit the display area.

SETUP MENU

SETUP MENU OPERATION

Use the setup menus to configure the various operational settings of the LED TV.







Displaying the setup menu screen

Press  on the remote control or **MENU** on the control panel to display the setup menu screen.

Navigating the setup menu screen

Use the buttons on the remote control or on the control panel to navigate through the menu screens.



Action	Remote Control	Control Panel
Displays or closes the menu bar.		MENU
<ul style="list-style-type: none"> Select and display a primary menu. Adjust sub-menu options. 	 /  then SELECT	VOL +/- then INPUT
<ul style="list-style-type: none"> Select and display a sub-menu. Select a sub-menu or a sub-menu option. 	 /  then SELECT	CH +/- then INPUT
<ul style="list-style-type: none"> Returns to the primary menu tab from a sub-menu screen. Returns to the previous screen. 		MENU
Applies the selected menu setting.	SELECT	INPUT

PICTURE

Use the Picture sub-menus to configure the display quality.

Press  on the remote control to display the setup menu screen then select **Picture** to display the Picture sub-menu. The following options are available: Picture Mode, Sound, Time, Setup, Lock, Channel.



Picture Settings

Adjust the picture quality including brightness, contrast, color, tint, sharpness.



Picture mode

Use this sub-menu to select one of four preset view options optimized for different viewing conditions.

The following options are available:



- **Energy Star:** Select for power saving picture.
- **Retail:** Select for enhanced picture contrast and sharpness
- **Movie:** Select for a finely detailed picture.
- **User:** Select for standard picture.

Brightness

Use Brightness to adjust the luminance level.

Adjusting Brightness





- 1 Use the▲ / ▼keys to select **Brightness** and press .
- 2 Press the◀ / ▶keys on the remote control to adjust the brightness level.
- 3 Press  to save and exit the screen.

Contrast

Use Contrast to adjust the brightness to darkness ratio.

Adjusting Contrast





- 1 Use the▲ / ▼keys to select **Contrast** and press .
- 2 Press the◀ / ▶keys on the remote control to adjust the contrast level.
- 3 Press  to save and exit the screen.

Color

Use Color to adjust the color intensity.

Adjusting Color



- 1 Use the▲ / ▼keys to select **Color** and press .
- 2 Press the◀ / ▶keys on the remote control to adjust the Color level.
- 3 Press  to save and exit the screen.



Tint

Use Hue to adjust the balance of the red, green, and blue colors in the display.

Adjusting Tint



The following options are available:



- 1 Use the▲ / ▼keys to select **Tint** and press .
- 2 Press the◀ / ▶Keys on the remote control to adjust the Tint level.
- 3 Press  to save and exit the screen.

Sharpness

Use Sharpness to adjust the sharpness or softness of the display.

Adjusting Sharpness



- 1 Use the▲ / ▼keys to select **Sharpness** and press .
- 2 Press the◀ / ▶keys on the remote control to adjust the sharpness level.
- 3 Press  to save and exit the screen.

Advanced Settings

Press ◀ / ▶ to select the display **aspect ratio** till the picture is fit onto the screen.
The options are different according to different input source.



- Use the ▲ / ▼ keys to select **Noise Reduction**, Press ◀ / ▶ to select Low Medium and High
- Use the ▲ / ▼ keys to select **Dynamic Contrast**, Press ◀ / ▶ to select on or off
- Use the ▲ / ▼ keys to select **HDMI Mode**, Press ◀ / ▶ to select Video or Graphic
- Use the ▲ / ▼ keys to select **Color Space**, Press **SELECT** to enter Color Mode, Color, Hue, Saturation, Brightness, Reset , adjust the TV setting.
- Use the ▲ / ▼ keys to select **White Balance**, Press **SELECT** to enter Red Gain, Green Gain, Blue Gain, Red Gain, Green Offset, Blue Offset, or Reset, adjust the TV setting.
- Press  to save and exit the screen.

SOUND

Use the Sound sub-menus to configure the sound quality.

Press  on the remote control to display the setup menu screen then select **Sound** to display the Sound sub-menu. The following options are available: Equalizer, MTS, Audio Language, Digital Audio Output, AVL, Surround HD.



Equalizer

Use this sub-menu to select one of four preset audio options optimized for different sounding conditions.

The following options are available:

- **Standard:** Select for standard sound.
- **Music:** Select for POP sound.
- **Movie:** Select for harmonious sound.
- **Sports:** Select for rhythm sound.
- **User:** Select for customized sound.





MTS

The following options are available:

- **Mono:** Allows mono output (useful when stereo is noisy or inconsistent).
- **Stereo:** Allows stereo sound for superior TV viewing experience.
- **SAP:** Allows second audio program from the speakers while watching a scene in the original program.

Adjusting MTS

- 1 Use the ◀ / ▶ Keys to select **MTS** and press 
- 2 Press the ◀ / ▶ keys on the remote control to select the desired option.
- 3 Press  to save and exit the screen.

Digital Audio Output (PCM/Raw/Off)

Set the audio output type of coax or optical terminal. Raw means output the original format of audio stream. PCM can be matched with most AV amplifiers.

AVL (On/Off)

Automatic volume control

Surround sound HD (On/Off)

Time

Use the Time sub-menus to configure the Time setting.



Sleep Timer

The following options are available:

- **Sleep timer:** Off/ 5 min / 10 min / 15 min / 30 min / 60 min / 90 min / 120 min / 180 min/ 240 min/ .

Adjusting Time

- 1 Use the ◀ / ▶ Keys to select **Time** and press
- 2 Press the ◀ / ▶ keys on the remote control to select the desired option.
- 3 Press to save and exit the screen.

Time Zone



The following options are available:

- **Time Zone:** Pacific/ Alaska / Hawaii/ Samoa / Newfoundland / Atlantic / Eastern / Central / Mountain

Adjusting Time

- 1 Use the ◀ / ▶ Keys to select **Time Zone** and press
- 2 Press the ◀ / ▶ keys on the remote control to select the desired option.
- 3 Press to save and exit the screen.

Daylight Saving Time

- 1 Use the ◀ / ▶ Keys to select **Daylight Saving Time** and press 
- 2 Press  repeatedly to check(enable) or uncheck(disable) Adjust for **Daylight Saving Time**.
- 3 Press  to save and exit the screen.

Time Format (12-hour/ 24-hour)

Auto Clock (On/Off)

If set it to On , the TV will sync the local clock according to the DTV broadcasting time automatically. Otherwise you can set the time manually.

If set Auto Clock to Off, then you can set the time manually .

Clock (Clock/AM/PM)

Setup

Use the Settings sub-menus to configure the LED TV operational setup and view the current firmware version.







Press  on the remote control to display the setup menu screen then select **Setup** to display the Settings sub-menu. The following options are available: Menu Language, OSD Timeout, Closed Caption, Other Settings, Restore Default.



Menu Language

Use Menu Language to select the language to display on the screen: English, French, or Spanish.



Adjusting Menu Language

- 1 Use the  /  keys to select **Menu Language** and press .
- 2 Press the  /  keys on the remote control to select **English, French or Spanish**.
- 3 Press  to save and exit the screen.

OSD Timeout

Use OSD Timeout to adjust the OSD duration on the screen: 5 sec, 15 sec, 30 sec, or 45 sec, 60 sec .

Adjusting OSD Timeout

- 1 Use the ▲ / ▼ keys to select **OSD Timeout** and press. 
- 2 Press the ◀ / ▶ keys on the remote control to select **5 sec, 15 sec, 30 sec, or 45 sec, 60 sec.**
- 3 Press  to save and exit the screen.

Closed Captions

Use Closed Captions to configure the settings for closed captioning in TV programs.



- **CC Mode**

Display or hide the CC.

- **Analog CC**

Select from below closed-caption modes for analog programs.

CC1,2,3,4: Displays corresponding caption channel of a analog program.
(Usually be set to CC1 for most programs).

Text1,2,3,4: Displays corresponding text service channel of a analog program.

- **Digital CC**

Applies only to digital channels with closed caption.

Service1,2,3,4,5,6: These are different service data channels.





- **Option**



The following options are available:

- **Mode:** Can be set to **Default** or **Custom**.
13. **Font Style:** Can be set to as **Default, Font 1, Font 2, Font 3, Font 4, Font 5, Font 6, or Font 7, Font 0**.
13. **Font Size:** Can be set to **As Default, Small, Medium, or Large**.
- **Font Edgy Style:** **Left Shadow, Right Shadow, Default, None, Raised, Depressed, Uniform**.
 - **Font Edgy Color:** **Red, Black, White, Green, Blue, Yellow, Magenta, cyan, Default**
13. **FG Color:** **Default, White, Red, Green, Blue, Yellow, Magenta, cyan**
- **BG Color:** **Default, Black, White, Red, Blue, Yellow, Magenta, cyan, Transparent**
13. **FG Opacity:** **Default, Solid, flashing, Transparent**
- **BG Opacity:** Can be set to as **Default, Solid, Translucent, Transparent, or Flashing**.

Adjusting Closed Captions Settings

- 1 Use the  keys to select **Closed Captions** and press .
- 2 Use the  keys to select the desired Closed Captions option.
- 3 Use the  keys to adjust the value.
- 4 Press  to save and exit the screen.

VGA Settings

Use VGA Settings to configure the settings for closed captioning in TV programs.



Auto

Automatically adjust Clock, Phase, H-Position and V-Position settings.

In order to get a good result, you should open a “filling the screen” picture before executing Auto Adjust.

H. Position

Shift the screen horizontal slightly to left or right.

V. Position

Shift the screen vertical slightly up or down.

Clock

Adjust the DB15 picture signal sampling clock rate.

Other Settings

Use Other Settings to configure the settings for audio On/Off in TV programs.



- 1 Use the▲ / ▼keys to select **Other Settings** and press .
- 2 Press the◀ / ▶keys on the remote control to adjust the Audio on/off.
- 3 For **Audio Only** On/Off

Restore Default

13. Use the▲ / ▼keys to select **Restore Default** and press



Lock

Press ▲ / ▼ to select the source you want to lock, then press **SELECT** to set it to lock. If anyone want to use this source, the password is needed.



Change Password





Change Password allows you to change your current password.

The following options are available:



- **Enter Old Password.**
- **Enter New Password.**
- **Confirm Password**

Changing Password

- 1 Use the ◀ / ▶ keys to select **Change Password** and press .
- 2 Use the Channel keys to enter the current password and press .
- 3 Use the Channel keys to enter the new password and press .
- 4 Use the Channel keys to enter the new password again for confirmation and press .
- 5 Press  to save and exit the screen.

System Lock (On/Off)



Input Block

Press ▲ / ▼ to select the source you want to lock, then press **SELECT** to set it to lock. If anyone want to use this source, the password is needed.



- **TV** (Unblock/Block).
- **AV** (Unblock/Block).
- **Component** (Unblock/Block).
- **HDMI** (Unblock/Block).
- **VGA** (Unblock/Block).

Changing Input Block

- 1 Use the ◀ / ▶ keys to select **Input Source** and press. 
- 2 Use the ◀ / ▶ keys to select **Unblock/Block** and press 
- 3 Press  to save and exit the screen.

US Rating

Rating system used at USA.

- **TV Rating:** Use this sub-menu to customize US TV Rating programs.

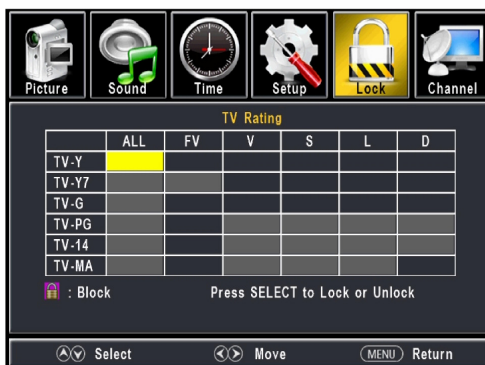

Rating	Description
TV-Y	Suitable for young children.
TV-Y7	May not be suitable for children under 7.
TV-G	Suitable for all audiences.
TV-PG	Parental guidance suggested.
TV-14	Parental guidance suggested for children under 14.
TV-MA	Suitable for mature audiences only; may be unsuitable for children under 17.
FV	Fantasy violence, combative situations.
D	Suggestive dialogue.
L	L Coarse language.
S	Sexual situations.
V	Violence.

13. **MPAA:** Use this sub-menu to select the ratings of allowable movies.



Rating	Description
Off	
G	Contains nothing most parents will consider offensive for even their youngest children to see or hear; suitable for young children.
PG	May contain some material parents might not like to expose to their young children-material that will clearly need to be examined or inquired about before children are allowed to view the film.
PG-13	May contain some scenes of drug use; use of one of the harsher sexually-derived words may be heard. May be inappropriate for preteens.
R	May contain some adult material. Parents are urged to learn more about the film before letting their children view it.
NC-17	May contain explicit sex scenes, an accumulation of sexually-oriented language, and/or scenes of excessive violence. Suitable for adult audiences only. Rating does not signify that the film is obscene or
X	Contains extreme violence or explicit sex; suitable for adult audiences only.

- **Canada Rating**

Rating system used at Canada.

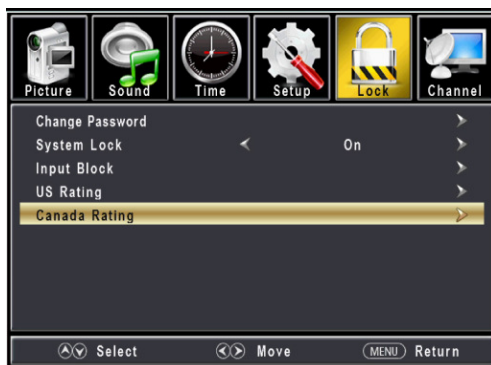

13. **Canada English:** Use this sub-menu to select the classification categories (based on Canadian ratings) of allowable TV programs and movies.



Rating	Description
Off	
C	Suitable for viewing by children of all ages.
C8+	Not suitable for children under 8 years of age.
G	Suitable for general audiences.
PG	Parental guidance advised.
14+	Suitable for people 14 years of age or older.
18+	Suitable for people 18 years of age or older.

13. **Canada French:** Use this sub-menu to select the ratings of allowable TV programs and movies. These ratings are based on the classification categories determined by La Régie du cinéma du Québec.



Rating	Description
Off	
G	For general audiences.
8 ans +	Not suitable for children under 8 years of age.
13 ans+	Not suitable for persons under 13 years of age.
16 ans+	Not suitable for persons under 16 years of age.
18 ans+	Not suitable for persons under 18 years of age.

CHANNEL

Use the Channel sub-menus to configure the channel.

Press  on the remote control to display the setup menu screen then select **Channel** to display the Channel sub-menu. The following options are available: Signal Type, Auto Scan, Favorite, Channel List, Show/Hide, Channel Number, Channel Label.



NOTE: The menu is available only at TV source.

Signal Type

Set to **Air** or **Cable** according to your antenna source. When **set to Air**, TV can Catch 8VSB broadcasting signal. When **set to Cable**, TV can catch analog and clear 64QAM/256QAM broadcasting signal.



Auto Scan

Select Auto Scan and press **ENT**. Two options are available:

- **Are you sure to auto Scan?**
- **No.**

Auto Search automatically creates a list of receivable channels for the selected source.



Favorite List

The following options are available: Channel, Channel Label, Favorite, Prev, Next.

All of your favorite channels are listed in this menu, and you can choose them quickly.



Channel List

The following options are available: Press  change Channel, Channel Label, Prev, Next.

You can view all the channels and choose one quickly.



“CH-1”: Label of the Channel

Show/Hide

The following options are available: Channel, Channel Label, Hide, Prev, Next.



Channel Number

The TV screen shows current TV channel.



Channel Label

Rename label of the channel..



WALL MOUNT OPTION

The LED TV has been fitted with VESA FPMPMI compliant mounting holes. These 200 x 100 mm mounting holes allow the unit to be mounted on a wall. Use the four M6 x L12 mm screws to wall mount the LED TV.

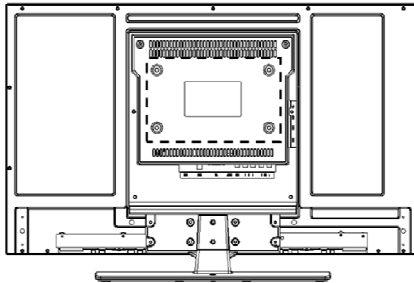

WALL MOUNT INSTALLATION REMINDERS

- Remove the LED TV base first before mounting the unit on a wall.
- It is the user's responsibility to use a UL listed wall mount unit rated to support the weight of this LED TV.
- Please consult qualified contractors for wall mount installation.

CAUTION:

The incomplete or improper mounting of this unit to a wall may cause it to fall down resulting to property damage and/or potentially serious injury.

TROUBLESHOOTING

Problem	Corrective Action
No power	<ul style="list-style-type: none"> • Make sure the power indicator is illuminated blue. • Make sure the power cord is securely connected to the AC-in jack and is plugged into a functional AC outlet. You may want to plug in another electrical device to the power outlet to verify that it is supplying the proper voltage.
Power is suddenly turned off.	Make sure the sleep timer is turned off.
Remote control does not work.	<ul style="list-style-type: none"> • Press only one button at a time. • Make sure the batteries are properly inserted. • The batteries may already be drained out. Replace batteries with new ones.
Remote control code cannot be detected by a universal remote.	<ul style="list-style-type: none"> • Purchase a separate learning remote control. • Go to www.wde.com for a list of remote codes.
No picture	<ul style="list-style-type: none"> • Make sure the video input cable is properly connected to the correct terminal, and that the correct input mode is enabled. To illustrate, when a VGA cable is connected to display a computer screen, the VGA input mode must be enabled. • Verify that the antenna is properly connected and that the preferred channel is enabled in the channel list. Press and select Channels/Channel List. • Adjust the display settings.
No picture or the No Signal message appears when a VGA cable is connected.	<ul style="list-style-type: none"> • Make sure the VGA cable is properly connected to the LED TV's VGA port. • Decrease the video resolution setting on the computer and try again. • Adjust the display settings.

Problem	Corrective Action
Picture is cut off or appear in a sidebar screen.	Press ⏏ to adjust the Aspect ratio.
Poor image quality in TV mode (cutoff picture, snowy images).	<ul style="list-style-type: none"> • Check your antenna connection. If necessary, rotate the antenna and wait up to ten seconds for a signal. • Reduce signal splitters and excessively long cables. • Replace poor antenna cables and/or connectors to improve signal quality. • Press ⏏ to adjust the Aspect ratio. • Adjust the Noise Reduction setting in Picture menu. • In HDMI mode, make sure the external device is compatible with the LED TV.
Wrong, abnormal or missing colors	<ul style="list-style-type: none"> • If any colors (red, green or blue) are missing, check the video cable to make sure it is securely connected. Loose or broken pins in the cable connector could cause an improper connection. • Adjust the Hue, Saturation and Color Temperature settings in Picture menu. • Connect the TV to another computer and check if the problem is with the computer screen.
No sound	<ul style="list-style-type: none"> • Make sure the audio input cable is properly connected to the correct terminal, and that the correct input mode is enabled. • The volume may be muted, press or Vol+ key to turn on the volume. • Adjust the Bass, Treble, and Balance settings in Audio menu. • If you are using the TV speakers, make sure the TV Speakers option is set to On in Audio menu. • If you are using an external audio device, press and select Audio to make sure the TV Speakers option is set to Off in Audio menu.

Problem	Corrective Action
<p>NOTES:</p> <p>If the problem condition persists even after performing the recommended corrective actions, contact us by:</p> <ul style="list-style-type: none">• Logging on to www.wde.com• Contacting the Westinghouse Customer Service at (800) 701-0680 or e-mail us at service@wde.com	

SPECIFICATIONS

Item	Specification	
Model Name	UW48T7HW	
Panel	Active Area (Diagonal, mm)	1054.08(H) x 592.92 (V)
	Resolution	1920 (H) x 1080 (V)
	Contrast Ratio (Typ.)	4000:1
	Response Time (Typ.)	6.5ms(g-g)
	Aspect Ratio	1.77 (16:9)
	Display color	16.7M
Audio/Video Input/Output Terminals	<ul style="list-style-type: none"> • HDMI x2 • AV with R/L Audio x1 • VGA with 3.5 mm mini jack x1 • SPDIF Out x1 • USB for service x1 • Tuner x1 	
Speaker Out	2X5W (2 channels)	
AV Timing	480i, 576i	
VGA Timing	640 x 400 @ 60Hz, 1680 x 1050 @ 60Hz 800 x 600 @ 60Hz, 1920x1080 @ 60Hz 1024 x 768 @ 60Hz, 1920x1200 @ 60Hz 1280 x 800 @ 60Hz, 1280x1024@ 60Hz 1360 x 768 @ 60Hz 1440 x 900 @ 60Hz	
Power Consumption (Watts)	≤ 90W (@ 19V DC)	
Power Consumption (Standby, Watts)	<1W	

SPECIFICATIONS

Item	Specification	
Physical Specifications	Dimensions (WxHxD)	With stand: 1097.56mm x 686.9mm x 173.98mm Without stand: 1097.56mm x 646.03mm x 53.94mm
	Weight (Net)	13.60 Kgs
	Weight (Gross)	17.86 Kgs

NOTES:

- These product specifications are subject to change without user notification.
- Do not set your computer graphics card to exceed the unit's refresh rates; doing so may cause damage to the LED TV.



www.westinghousedigital.com

┌
S/N: _____
Westinghouse Digital, LLC
Orange, CA

Free Manuals Download Website

<http://myh66.com>

<http://usermanuals.us>

<http://www.somanuals.com>

<http://www.4manuals.cc>

<http://www.manual-lib.com>

<http://www.404manual.com>

<http://www.luxmanual.com>

<http://aubethermostatmanual.com>

Golf course search by state

<http://golfingnear.com>

Email search by domain

<http://emailbydomain.com>

Auto manuals search

<http://auto.somanuals.com>

TV manuals search

<http://tv.somanuals.com>