



Westinghouse

USER'S MANUAL
MANUEL DE L'UTILISATEUR
MANUAL DEL USUARIO

SK-32H540S

Widescreen HDTV

TVHD à Écran Géant

TVHD Pantalla Grande

TABLE OF CONTENTS

IMPORTANT INFORMATION	2
1. WARNINGS	2
2. SAFETY GUIDELINES	3
3. IMPORTANT SAFETY INSTRUCTIONS.....	4
4. ANTENNA INSTALLATION SAFETY	6
5. CLEANING THE LCD TV	6
SYSTEM TOUR	7
1. PACKAGE CONTENTS.....	7
2. CONTROL PANEL	8
3. TERMINALS.....	9
4. REMOTE CONTROL.....	10
INSTALLATION	12
1. LCD TV BASE	12
2. REMOTE CONTROL BATTERIES.....	14
3. ANTENNA CONNECTION.....	15
4. EXTERNAL DEVICE CONNECTIONS.....	17
5. POWER CONNECTION	19
6. INITIAL SETUP.....	19
BASIC OPERATION	20
1. TURNING THE POWER ON AND OFF.....	20
2. ADJUSTING THE VOLUME.....	20
3. CHANGING CHANNELS	21
4. SELECTING THE INPUT SOURCE	21
5. ADJUSTING THE DISPLAY FORMAT	22
6. ADJUSTING THE LCD BACKLIGHT.....	22
SETUP MENUS	23
1. SETUP MENU OPERATION	23
2. MENU SETTING SCREENS	24
SPECIFICATIONS	52
TROUBLESHOOTING	53
APPENDIX A - LCD TV BASE REMOVAL	54
1. ANTI-TIPPING MECHANISM	55
2. ANTI-THEFT PROTECTION	55
APPENDIX B - SAFETY BRACKETS	55
APPENDIX C - WALL MOUNT OPTION	56

IMPORTANT INFORMATION

English

1. WARNINGS

WARNING!

(1) Risk of electric shock. DO NOT open.

(2) To reduce the risk of fire or electric shock, do not expose this product to rain or moisture.

(3) To reduce the risk of electric shock, do not remove the rear cover. There are no user-serviceable parts inside. Refer all servicing requirements to qualified service personnel.



The lightning flash with arrowhead inside an equilateral triangle symbol is intended to alert the user to the presence of uninsulated dangerous voltage within the product's enclosure that may be of sufficient magnitude to constitute a risk of electric shock.



The exclamation inside an equilateral triangle symbol is intended to alert the user to related operating and maintenance instructions in the user documentation accompanying the product.

IMPORTANT INFORMATION

2. SAFETY GUIDELINES

WARNING: This device must be operated with the original power supply.

CAUTION: The power supply outlet should be located near the LCD TV and should be easily accessible. Always use the appropriate AC cord that is certified for your specific country. Some examples are listed below:

USA.....UL
Japan Electric Appliance Control Act
Canada.....CSA

IMPORTANT NOTICES CONCERNING POWER CORD SELECTION

The specific power cord for this LCD TV is enclosed and has been selected according to the country of destination. Use the enclosed power cord to prevent electric shock. Observe the following guidelines if it is necessary to replace the original cord set, or if there is no cord set enclosed. The female receptacle of the cord set must meet IEC-60320 requirements and should look like Figure A1 below:



For the United States and Canada

In the United States and Canada the male plug is a NEMA5-15 style (Figure A2), UL-listed, and CSA-labeled. For LCD TVs that are to be placed on a desk or table, type SVT or SJT cord sets may be used. For LCD TVs that are to be placed directly on the floor, only SJT type cord sets may be used. The cord set must be selected according to the current rating for the LCD TV. Consult the table below for the selection criteria of power cords used in the United States and Canada.

Cord Type	Size of Conductors in Cord	Maximum Current Rating of Unit
SJT	18 AWG	10 Amps
	16 AWG	12 Amps
	14 AWG	12 Amps
SVT	18 AWG	10 Amps
	17 AWG	12 Amps

FCC COMPLIANCE STATEMENT

This equipment has been tested and complies with the limits for a Class B digital device, pursuant to part 15 of the FCC Rules. These limits are designed to provide reasonable protection against harmful interference in a residential installation. This equipment generates, uses, and can radiate radio frequency energy, and may cause harmful interference to radio communications if not installed and used in accordance with the instructions. However, there is no guarantee that interference will not occur in a particular installation. If this equipment does cause harmful interference to radio or television reception, which can be determined by turning the equipment off and on, the user is encouraged to try to correct the interference by one or more of the following measures:

- Reorient or relocate the receiving antenna.
- Increase the distance between the LCD TV and the receiver.
- Connect the LCD TV to an outlet on a circuit separate from to which the receiver is connected.
- If the interference persists even after performing the above measures, consult the Westinghouse Service Center or an experienced radio/TV technician for assistance.

FCC Warning

To assure continued FCC compliance, use a grounded power supply cord and the provided shielded video interface cable with bonded ferrite cores. If a BNC cable is used, use only a shielded BNC (5) cable. Also, any unauthorized changes or modifications not expressly approved by manufacturer will void the user's authority to operate this device.

IMPORTANT INFORMATION

English

3. IMPORTANT SAFETY INSTRUCTIONS

Make sure to note and follow all warnings and instructions marked on the LCD TV. Observe the following safety instructions.

- Read and understand all the safety and operating instructions in this manual before you use the LCD TV.
- Keep this user manual for future reference.
- Do not use the LCD TV near water.
- Avoid exposing the LCD TV to moisture or high humidity.
- Do not install near any heat sources such as radiators, heat registers, stoves, or other apparatus (including amplifiers) that produce heat.
- Avoid exposing the LCD TV to direct sunlight or high temperatures.
- Do not install near a motor or transformer where strong magnetism is generated.
- Do not attempt to bypass the safety purpose of the polarized or grounding-type plug. A polarized plug has two blades with one wider than the other. A grounding-type plug has two blades and a third grounding prong. If the provided plug does not fit into your wall outlet, consult an electrician for replacement of the obsolete outlet.
- Protect the power cord from being walked on or pinched particularly at the ends of the cord.
- Only use attachments and accessories specified by the manufacturer.
- Use only with a cart, stand, tripod, bracket, or table specified by the manufacturer, or sold with the LCD TV. When a cart is used, use caution when moving the cart to avoid injury or damage.



- Unplug the LCD TV during lightning storms or when it will not be used for a long period of time.
- Refer all servicing to qualified service personnel. Do not attempt repairs yourself. The product warranty does not cover repairs or attempted repairs by anyone not authorized by the manufacturer. Servicing is required when:
 - the LCD TV has been dropped, or otherwise damaged in any way.
 - liquid has been spilled into or objects have fallen onto the LCD TV.
 - the LCD TV has been exposed to rain or moisture and does not operate normally

Circuit Overload

Do not overload wall outlets, extension cords, or power strips. This can result in a fire or electronic shock.

Power Cord Protection

Power supply cords should be routed so that they are not likely to be walked on or pinched by items placed upon or against them. Periodically inspect the cords for damage. Install the LCD TV near a wall socket outlet where the power cord can be readily access.

Ventilation

The slots and openings on the cabinet are provided for necessary ventilation. To ensure reliable operation of the LCD TV and to protect it from overheating, these slots and openings must never be blocked or covered.

IMPORTANT INFORMATION

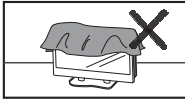

Never cover the slots and openings with a cloth or other materials.

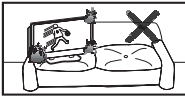

Do not block the openings by placing the LCD TV on a bed, sofa, rug or other similar surface.



Do not place the LCD TV in a built-in installation such as a bookcase or a rack unless proper ventilation is provided or the manufacturer's instruction have been adhered to.

English

Warnings and Precautions

- Do not orient the LCD TV towards direct sunlight to reduce glare.
- If the LCD TV will not be used for a long period of time, unplug the unit and remove the batteries from the remote control.
- Avoid touching the display screen by hand or any object.
- Never remove the rear cover. The LCD TV interior contains high-voltage parts. You may be seriously injured if you touch them.
- Always handle the LCD TV with caution when moving it.
- Do not install the LCD TV in airtight compartments, or in areas where it can be exposed to water or high temperature.
- Ensure that the area around the LCD TV is clean and free of moisture.
- Do not place anything on the LCD TV that can hinder heat dissipation.
- Do not place anything on the LCD TV that can cause liquid to splash on it (e.g. flower vase).
- Do not place heavy objects on the LCD TV, audio/video cables, or power cord.
- If the LCD TV emits smoke, abnormal noise, or a strange odor, immediately turn it off and contact the Westinghouse Service Center by:
 - logging on to www.wde.com
 - contacting the Westinghouse Customer Service at (866) 287-5555.
 - e-mailing us at service@wde.com

Dolby-Digital Notice



Manufactured under license from Dolby Laboratories. Dolby and the double-D symbol are registered trademarks of Dolby Laboratories.

Fabriqué sous licence de Dolby Laboratories. Dolby et le symbole du double D sont des marques de commerces de Dolby Laboratories.

IMPORTANT INFORMATION

4. ANTENNA INSTALLATION SAFETY

Outdoor Antenna Grounding

If an outside antenna or cable system is connected to the LCD TV, be sure the antenna or cable system is grounded to prevent voltage surges and built-up static charges. Article 810 of the National Electrical Code, ANS/NFPA 70, provides information on proper grounding of the mast and supporting structure, grounding of the lead-in wire to an antenna discharge unit, connection to grounding electrodes, and requirements for the grounding electrode.

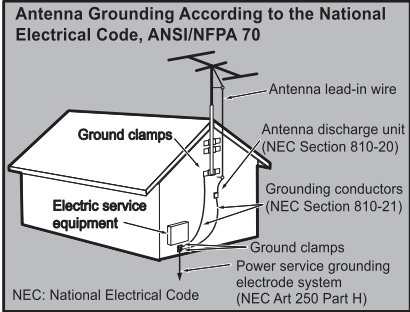

Lightning

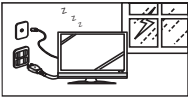

For added protection for the LCD TV during a lightning storm, or when it is left unattended and unused for long periods of time, unplug it from the wall outlet and disconnect the antenna or cable system. DO NOT disconnect the antenna or the power cord during a heavy storm—lightning may strike while you are holding the cable cord, causing serious injury. Turn off the LCD TV and wait for the weather to improve.

Power Lines

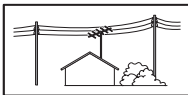

An outside antenna system should not be located in the vicinity of overhead power lines or other electric light or power circuits, or where it can fall into such power lines or circuits. When installing an outside antenna system, extreme care should be taken to keep from touching such power lines or circuits as contact with them might be fatal.

5. CLEANING THE LCD TV

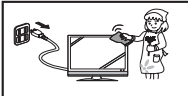

- MAKE SURE THE LCD TV IS TURNED OFF AND THE POWER CORD IS DISCONNECTED FROM THE POWER OUTLET.
- NEVER SPRAY OR POUR ANY LIQUID DIRECTLY ONTO THE SCREEN OR THE CASE.

To clean the screen:

- (1) Wipe the screen with a clean, soft, lint-free cloth. This removes dust and other particles.
- (2) If it still is not clean, apply a small amount of non-ammonia, non-alcohol based glass cleaner onto a clean, soft, lint-free cloth, and wipe the screen.







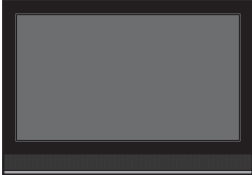

To clean the case:

- (1) Wipe the case with a soft, dry cloth.
- (2) If it still is not clean, apply a small amount of non-ammonia, non-alcohol based, mild non-abrasive detergent onto a clean, soft, lint-free cloth, then wipe the surface.

SYSTEM TOUR

1. PACKAGE CONTENTS

English

32" LCD TV Unit	Remote Control (with 2x AAA batteries)
	
LCD TV Base	Base Screws (4x) and Screwdriver (1x)
	
Power Cord	Quick Connect Guide
	
User Manual	Warranty Card
	

SYSTEM TOUR

2. CONTROL PANEL

English

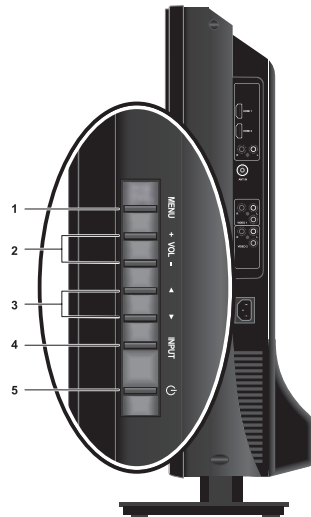

1. MENU	Display the LCD TV setup screen.
2. VOL + / -	During playback, adjust the volume. In a menu screen, select an item.
3. CH + / -	During TV viewing, adjust the channel. In a menu screen, select an item.
4. INPUT	Select the video source. In a menu screen, select an item.
5. 	Toggles the power on and off.

3. TERMINALS

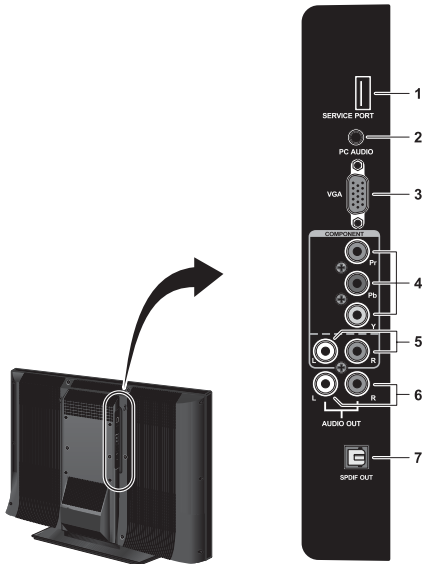

- | |
|---|
| 1. Service
For service/maintenance purposes only. |
| 2. PC Audio Input
Connect to the audio out port (green) of a computer. |
| 3. VGA
Using a 15-pin VGA cable, connect to a computer or other device with a VGA output. |
| 4. YPbPr Input
Connect an external video device with component output to these jacks. |
| 5. YPbPr Audio Input (Left/Right)
Connect an external audio source to these jacks. |
| 6. Analog Audio Output (Right/Left)
Connect this output to an external analog audio receiver. |
| 7. SPDIF Audio Output
Connect this output to an external digital audio receiver. |

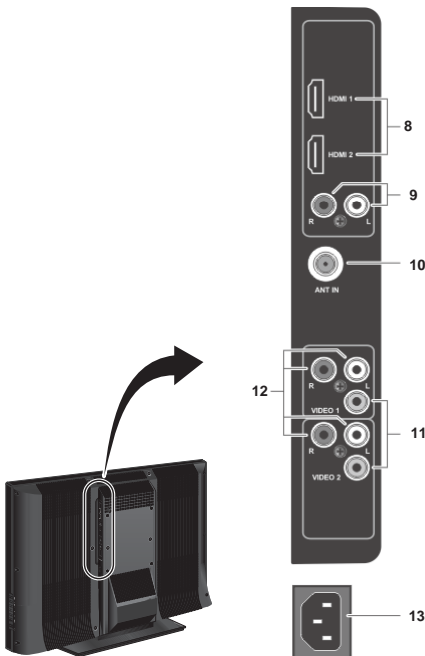

- | |
|---|
| 8. HDMI 1/2
Connect to an external video device such as a DVD player, game system, cable, or satellite box. |
| 9. HDMI Audio Input (Right/Left)
Connect an external audio source to these jacks. |
| 10. TV Tuner
Connect the LCD TV to an antenna or cable service. Supports NTSC, ATSC, and cable formats. |
| 11. Composite Video Input 1/2
Connect to an external video device with an analog signal such as a VCR. |
| 12. Composite Audio Output 1/2 (Right/Left)
Connect this output to an external audio receiver. |
| 13. AC In
Connect the power cord from this outlet to a power source. |

SYSTEM TOUR

4. REMOTE CONTROL



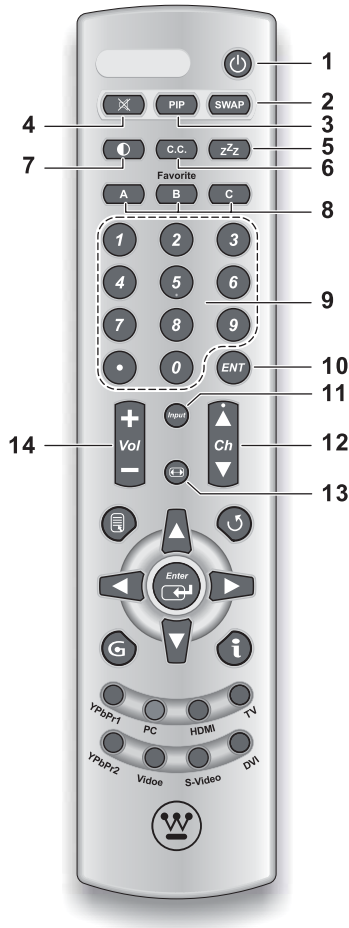

English

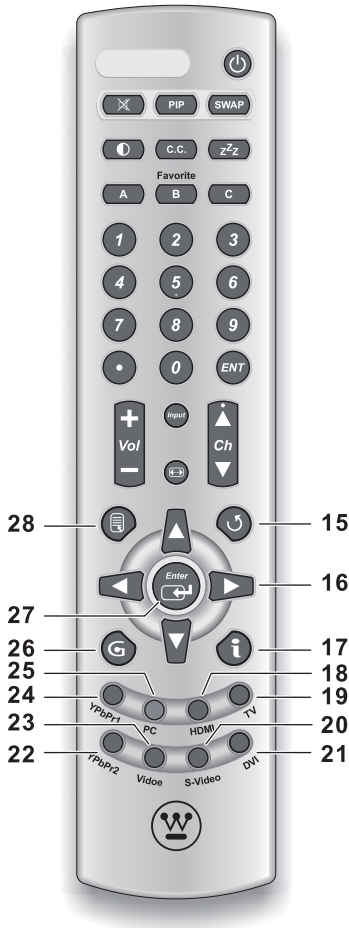

1. Power	Toggle the TV power on and off.
2. SWAP	Function not available for this model.
3. PIP	Function not available for this model.
4. Mute	Mute the sound. Press it again to toggle the sound back on.
5. Sleep zZz	Set the sleep timer for the LCD TV to turn off automatically.
6. C. C.	Toggle the closed caption display on and off. For more information on this feature, go to page 34.
7. Backlight	Adjust the LCD screen backlight.
8. Favorite	Function not available for this model.
9. Channel keys	Key in the channel number. Go to page 20 for instructions on how to change channels using these keys.
10. Enter ENT	Execute a channel entry.
11. Input	Select the video input source. Go to page 20 for instructions on how to use this key.
12. Ch	Change the current TV channel.
13. Aspect Ratio	Select the video display format. Options include Standard, Fill, and Overscan. Go to page 21 for a description of these options.
14. Vol +/-	Adjust the system volume.

SYSTEM TOUR



15. Return 	Switch to the previous channel.
16. Arrow keys ▲/▼/◀/▶	Navigate through the on-screen menu selections.
17. Info 	Display the input source or channel information.
18. HDMI	Enable HDMI 1 or HDMI 2 as the input source.
19. TV	Enable TV or HDTV as the input source.
20. S-Video	Function not available for this model.
21. DVI	Function not available for this model.
22. YPbPr2	Function not available for this model.
23. Video	Enable Composite 1 or Composite 2 as the input source.
24. YPbPr1	Enable YPbPr as the input source.
25. PC	Enable VGA as the input source.
26. Guide 	Display the electronic program guide (EPG). EPG availability depends on your digital TV provider
27. Enter 	Execute a command.
28. Menu 	Display the LCD TV setup screen.

INSTALLATION

1. LCD TV BASE

English

- (1) Open the LCD TV carton box.
- (2) Remove the LCD TV base from the carton box.
- (3) Remove the two top carton stabilizers from the LCD TV.
- (4) Remove the protective plastic covering the LCD TV.
- (5) Grasp the two sides of the LCD TV and then pull it out of the carton box.
- (6) Remove the two bottom carton stabilizers from the LCD TV.

CAUTION:

The LCD TV unit may be too heavy for one person to lift. If this is the case, make sure to ask assistance in handling the LCD TV to prevent physical injury and/or damage to the unit.

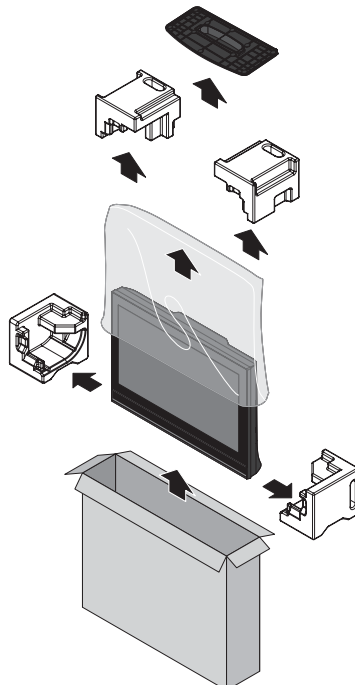

- (7) Lay the LCD TV on a clear, flat, and stable surface.
- (8) Remove the plastic bag containing the LCD TV base screws and screwdriver from the LCD TV base.

INSTALLATION

(9) Align the base to the bottom side of the LCD TV.

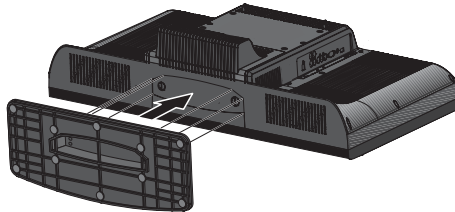

(10) Secure the base to the LCD TV with the four bundled screws.

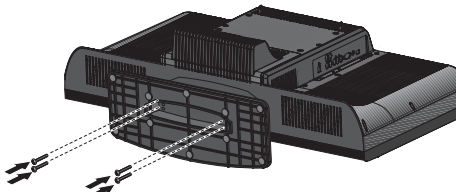

(11) Carefully orient the LCD TV in an upright position.

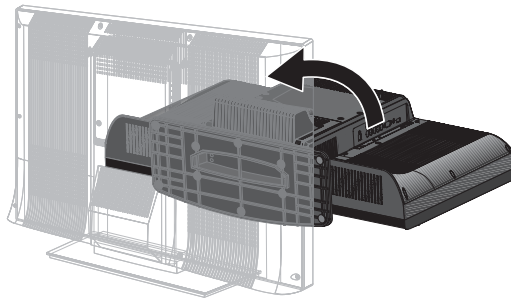

English

INSTALLATION

2. REMOTE CONTROL BATTERIES

English

- (1) Remove the battery cover.
- (2) Insert the batteries. Make sure the (+) and (-) marks on the batteries match those inside the compartment.
- (3) Re-attach the battery cover.

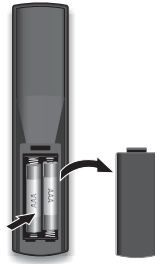

CAUTION:

- (1) Only use AAA batteries.
- (2) Do not mix new and old batteries. This may result in cracking or leakage, which may pose a fire risk or lead to personal injury.
- (3) Insert batteries according to the (+) and (-) markings. Inserting the batteries incorrectly may result in cracking or leakage, which may pose a fire risk or lead to physical injury.
- (4) Dispose of used batteries in accordance with local laws and regulations.
- (5) Keep batteries away from children and pets.
- (6) When the remote control will not to be used for an extended period, remove the batteries.

Remote Control Transmission Range

Transmission range depends upon the reception angle. The range of coverage is 20° horizontal/vertical at a distance of 20 feet from the LCD TV.

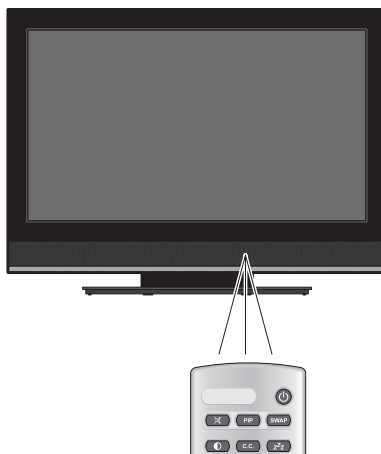

3. ANTENNA CONNECTION

Outdoor Antenna Connection

English

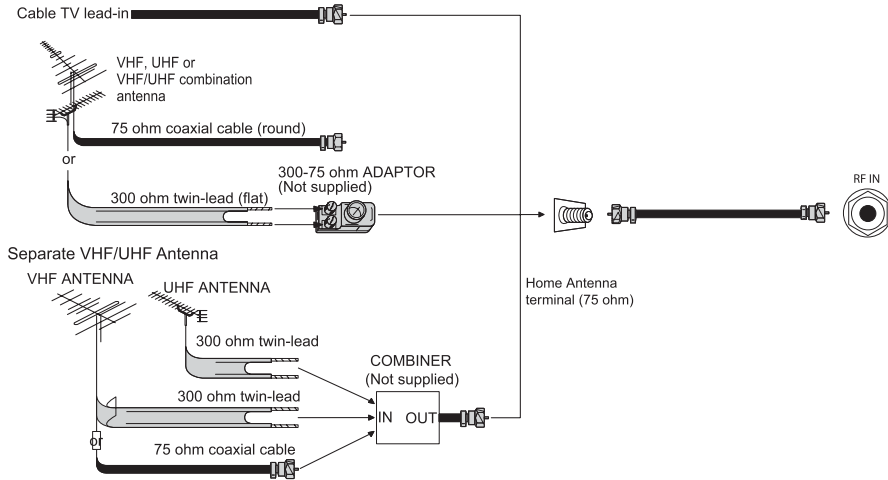

► **NOTE:**

The F-type connector should be finger-tightened only.

When connecting the RF cable to the LCD TV, do not tighten F-type connector with any tool. If tools are used, it may cause damage to the LCD TV (e.g. breaking of internal circuit).

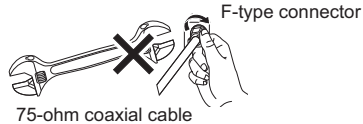

INSTALLATION

Cable TV (CTV/DTV) Connection

English

The unit has a TV tuner (75 ohm coaxial cable connector) located on the right I/O panel for for easy cable hookup. When connecting the 75 ohm coaxial cable to the unit, screw the 75 ohm cable to the TV tuner.

Some cable TV companies offer premium pay channels. Since the signals of these channels are scrambled, a cable TV converter/descrambler is usually provided to the subscriber by the cable TV company. This converter/descrambler is necessary for normal viewing of the scrambled channels. (Set your TV to channel 3 or 4. Typically one of these channels is used. If a channel is unknown, consult your cable TV company.) For more specific instructions on installing cable TV, consult your cable TV company. One possible method of utilizing the converter/descrambler provided by your cable TV company is explained below.

A position on the RF switch (not supplied): You can view all unscrambled channels by using the TV's channel keys.

B position on the RF switch (not supplied): You can view the scrambled channels via the converter/descrambler by using the converter's channel keys.

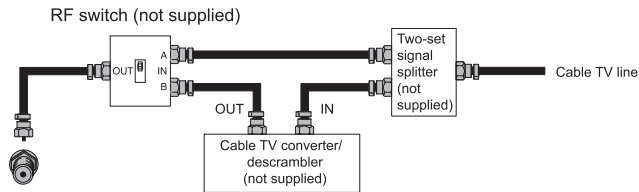

4. EXTERNAL DEVICE CONNECTIONS

You can enjoy picture and sound by connecting various audio-video devices to the terminals located on the left and right I/O panels of the LCD TV.

IMPORTANT:

Turn off the LCD TV first before connecting an external device to prevent any possible damage or physical injury.

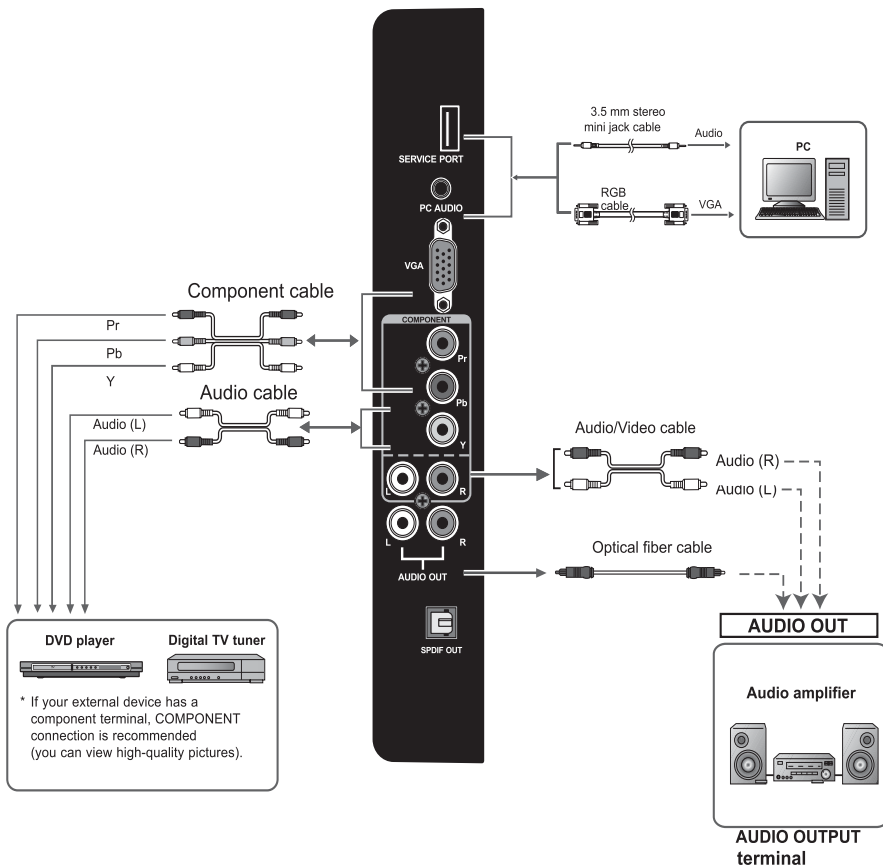

INSTALLATION

English

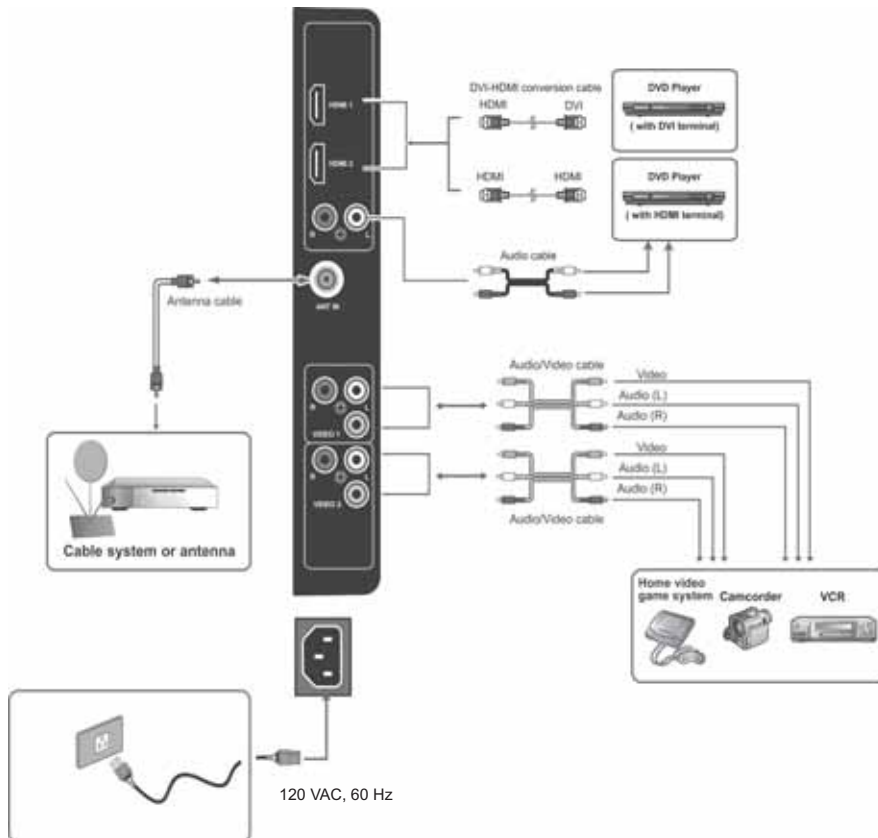

- For more information about external device connections, see the operation manual of the external device you wish to connect to the LCD TV.
- Make sure that the correct cables are connected to each terminal. Improper cable connections may cause damage to the LCD TV.
- TV cable input: You can use a commercially available audio/video cable.
- Component (YPbPr) input: Picture can be displayed only when a 480i, 480P, 720P or 1080i signal is received.
- HDMI input: Picture can be displayed only when a 640 x 480, 480P, 720P or 1080i signal is received. When you connect to the HDMI terminal with a DVI-HDMI conversion cable, there is a possibility that the picture may not display correctly.
- Audio output: You can output audio signals from the LCD TV set through the analog audio out and SPDIF terminals.
- This TV does not support DTS audio format. You may not hear proper audio output from the TV speakers if you choose a DTS audio format.

INSTALLATION

5. POWER CONNECTION

Connect the power cord to the LCD TV then to a proper AC outlet.



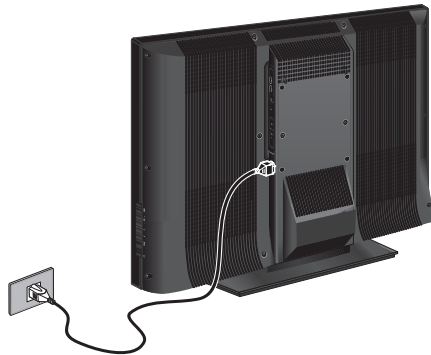

IMPORTANT:

The LCD TV works on a 120 VAC, 60 Hz power input voltage ONLY. Turn off all connected devices before plugging in the power cord.

English



6. INITIAL SETUP

Press  on the control panel or on the remote control to turn on the LCD TV. When you turn on the LCD TV for the first time, you will be prompted to perform a channel scan. Use the / keys to select a channel source and then press .

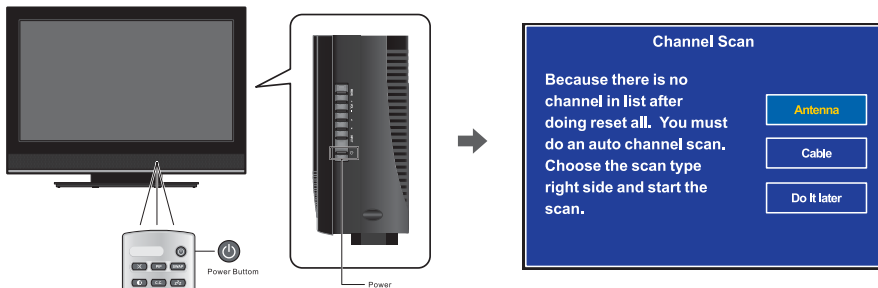

BASIC OPERATIONS

English

1. TURNING THE POWER ON AND OFF

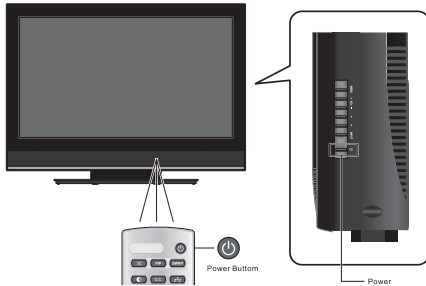

Indicator Status	Description
Power on	Blue light
Standby mode (DPMS on)	Amber light
Power off	No light

► **NOTE:**
For more information on power mode configuration, go to page 41.

To turn on the power:

Press  on the control panel or on the remote control.

To turn off the power:

Press  on the control panel or on the remote control. The LCD TV shut down behavior will depend on the enabled Power Mode setting. Go to page 41 for related information.

► NOTES:

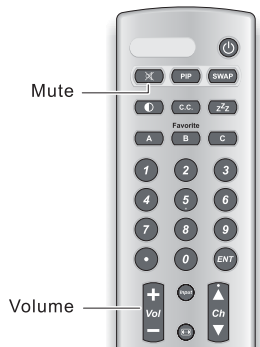

- If you are not going to use the TV for a long time, be sure to disconnect the power cord from the wall outlet and remove the batteries from the remote control.
- In standby mode, a small amount of electricity is still consumed even when the power is turned off.

2. ADJUSTING THE VOLUME



- Press **Vol+** to increase the volume. The bar indicator shifts right. Press **Vol-** to decrease the volume. The bar indicator shifts left.



- Press  to turn off the sound. *Mute* appears on the volume bar. Press  again to turn on the sound.



BASIC OPERATIONS

3. CHANGING CHANNELS

There are several ways to change channels. Unless otherwise indicated, the buttons referred to in the following instructions are located on the remote control.

Using the Ch ▲/▼ Buttons

To browse through the available channels, press **Ch▲** or **Ch▼** on the remote control or on the control panel.



Using the Channel Keys

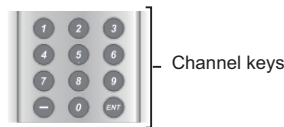

To use the Channel Select function:

Key in the channel number using the 0 thru 9 buttons and then hold down the button for the last digit.

To select a standard channel:

Complete the following steps within 4 seconds. You can enter a single, double, or triple digit channel number (7, 12, 012, etc.).

- (1) Key in the channel number using the 0 thru 9 buttons.
- (2) Press **ENT**.

To select a digital channel:

Complete the following steps within 4 seconds.

- (1) Key in the main channel number using the 0 thru 9 buttons.
- (2) Press **•**.
- (3) Key in the sub-channel number using the 0 thru 9 buttons.
- (4) Press **ENT**.

4. SELECTING THE INPUT SOURCE

There are two ways to select the video input source.

Using the Individual Input Keys

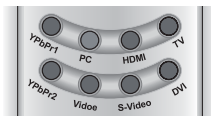

Press any of the following remote control keys to change the input source: **YPbPr1**, **PC**, **HDMI**, **TV**, or **Video**.

The **YPbPr2**, **S-Video** and **DVI** input keys are non-functional in this LCD TV model.

BASIC OPERATIONS

English

Using the Input Key



- (1) Press **Input**.
- (2) Press **▲/▼** to select the preferred source.
- (3) Press **↔** to switch to the selected input source.

► **NOTE:**

If you enabled the Autosource function, the TV will automatically detect and switch to a new input connection (e.g. The TV will automatically switch to PC mode when you connect to a computer.). Go to page 41 for instructions on how to enable this function.

5. ADJUSTING THE DISPLAY FORMAT

The input source can sometimes affect the way images are displayed on-screen. You can adjust the display format to view the image properly.



- (1) Press **↔**.
- (2) Press **▲/▼** to select the preferred display format. Options include:
 - Standard – Picture is displayed in its original size.
 - Fill – Picture is displayed to cover the entire screen.
 - Overscan – Picture is scaled down to fit the display area.
- (3) Press **↔** to apply the new display format.

6. ADJUSTING THE LCD BACKLIGHT

Different viewing conditions can affect the quality of the display. You can adjust the LCD backlight to suit the current way you

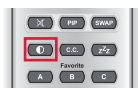

- (1) Press **⦿**.
- (2) Press **▲/▼** to adjust the backlight to your preferred level.



SETUP MENUS

1. SETUP MENU OPERATION

Use the setup menus to configure the various operational settings of the LCD TV.



To display the setup menu screen:

Press  on the remote control or **MENU** on the control panel.

To navigate through the setup menu screen:

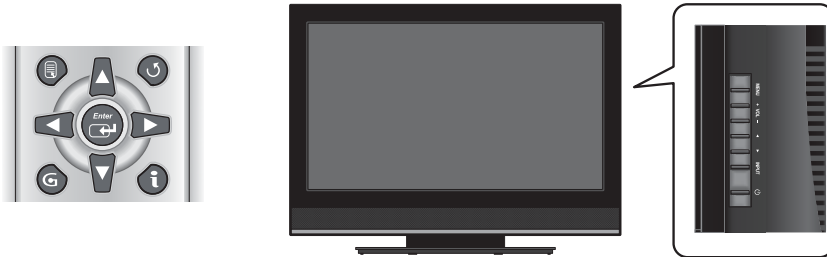
Use the buttons on the remote control or on the control panel to navigate through the menu screens.



Action	Remote Control Key	Control Panel Button
Display or close the menu screen.		MENU
<ul style="list-style-type: none"> Select and display a primary menu. Adjust sub-menu options expressed in levels (e.g. brightness level, volume level). 	◀/▶ → Enter	CH + / - → INPUT
<ul style="list-style-type: none"> Select and display a sub-menu. Select a menu or a sub-menu option. 	▲/▼ → Enter	VOL + / - → INPUT
<ul style="list-style-type: none"> Return to the primary menu tab from a sub-menu screen. Return to the previous screen. 	◀ or 	CH + or INPUT
Apply the selected menu setting or cycle though available menu options.	Enter	INPUT

► NOTES:

- Available menu options depends on the current LCD TV settings.
- A selected menu, sub-menu, or menu option is displayed in yellow.
- The last viewed menu or sub-menu screen will be displayed the next time you press .

SETUP MENUS

2. MENU SETTING SCREENS

English

There are five primary LCD TV setup menus. For details on the options available for these menus, refer to the page numbers indicated below.

Picture

	Page
Settings.....	26
View Mode.....	27
Presets.....	27
Advanced.....	28
Reset.....	29

Audio

	Page
Bass.....	30
Treble.....	30
Balance.....	30
Analog Audio.....	31
Digital Audio.....	31
SPDIF.....	32
Level Set.....	32
TV Speaker.....	33
Reset.....	33

Channels

	Page
Channels List.....	34
Antenna Scan.....	35
Cable Scan.....	35

Settings

	Page
Closed Captions.....	36
Sleep Timer.....	40
PC/VGA.....	40
Menu Language.....	41
Date & Time.....	41
Power Mode.....	43
Autosource.....	43
Custom Label.....	44
FW Version.....	44
Reset All.....	45

Locks

	Page
Rating Locks.....	46
Change PIN.....	51
Reset Locks.....	52

► NOTES:

- The screenshots used in this manual are for explanation purposes only and may differ in appearance from those displayed on your LCD TV.
- Depending on the current LCD TV settings, for example the input source, it may not be possible to view or adjust some menu items.

A. PICTURE

Use the Picture sub-menus to configure the display quality.

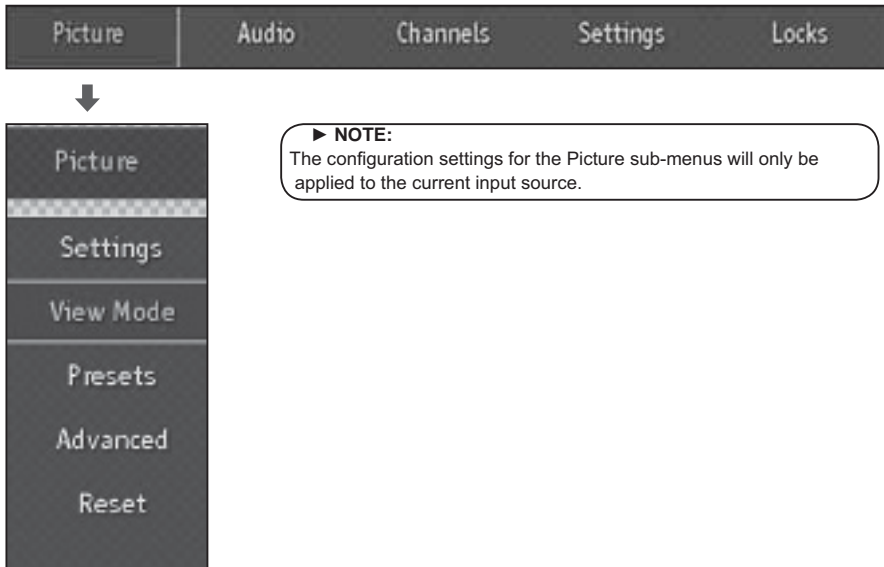

A-1 Settings

Use the Settings sub-menu options to manually adjust the display quality. Use the ◀▶ keys to adjust the option level.

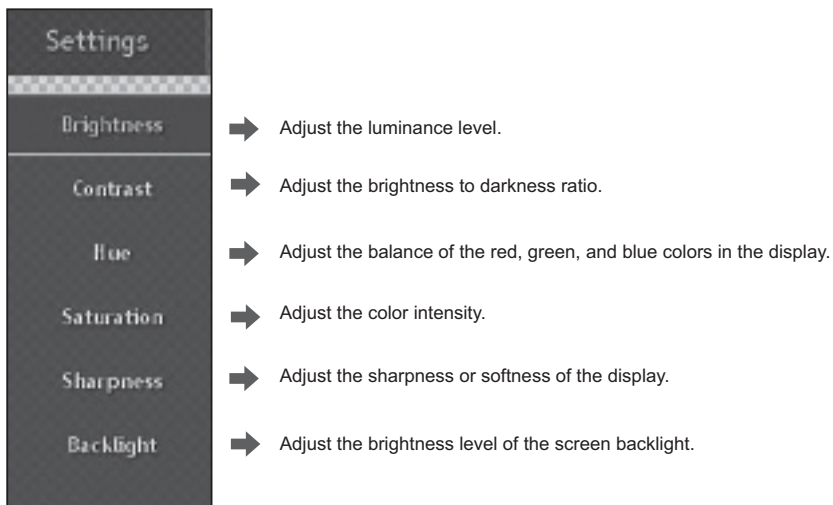

SETUP MENUS

English

A-2 View Mode

Use this sub-menu to select the display's aspect ratio. Use the ▲/▼ keys to select the preferred setting.

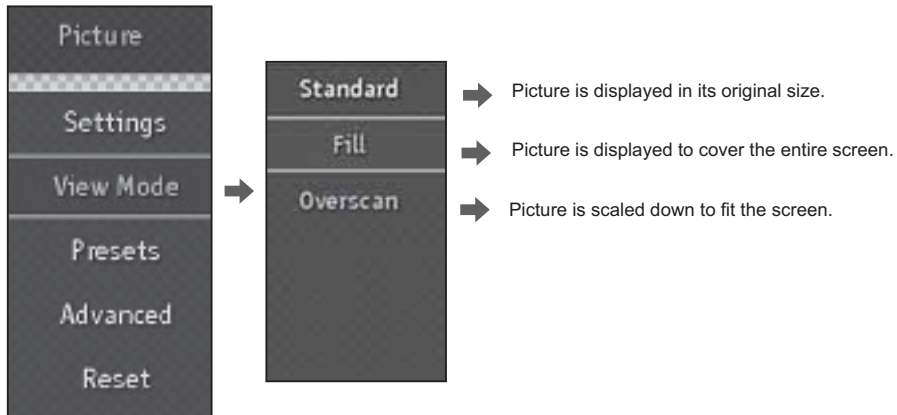

A-3 Presets

Use this sub-menu to select one of five preset view options optimized for different viewing conditions.

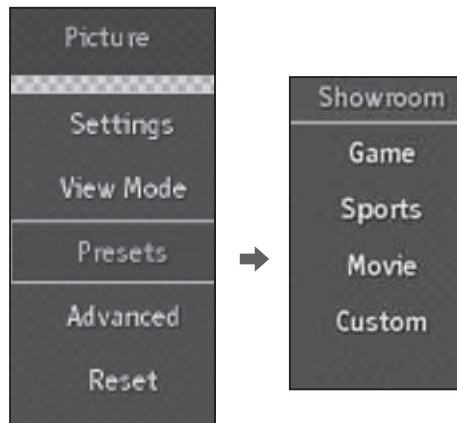

Preset Option	Description
Showroom	Increased color and sharpness for a vibrant picture display.
Game	Increased brightness and response time level for enjoying video games.
Sports	High contrast display for clear-cut images ideal for viewing sports events.
Movie	Images are displayed as accurately near to its original recording condition.
Custom	Allows the user to customize the display settings and select to which input source should the customize settings be applied.



SETUP MENUS

A-4 Advanced

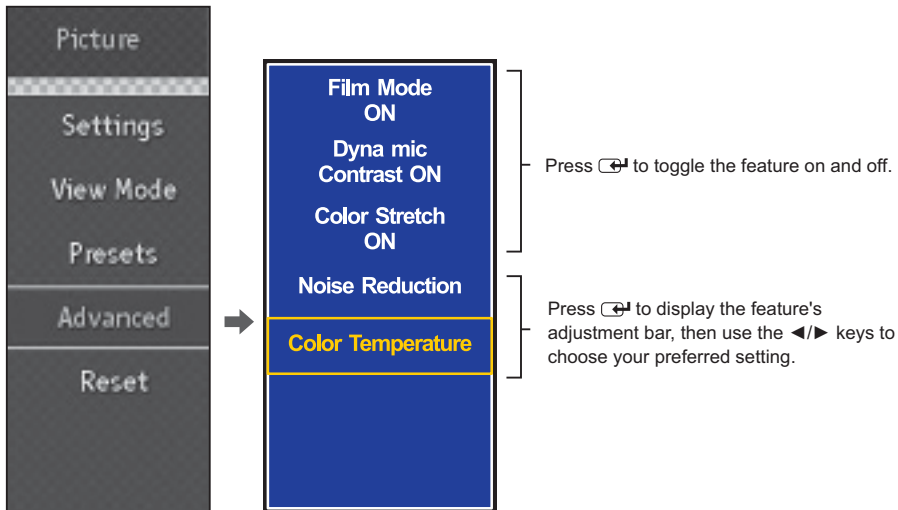
Select this sub-menu to adjust the picture quality in more detail.



English

Feature	Description
Film Mode	This feature improves the appearance of movies converted from film (originally encoded at 24 frames/second) to video, including DVD titles. When enabled picture is less jerky and has a cinematic picture quality.
Dynamic Contrast	This feature enables automatic contrast adjustment based on the picture brightness.
Color Stretch	This feature allows for a more vivid color display.
Noise Reduction	This feature improves picture quality from a weak broadcast signal. There are four available settings as indicated below: 
Color Temperature	Color temperature refers to the level of white balance in the display. There are four available settings:  <ul style="list-style-type: none"> • Warm - Pictures appear more reddish. • Neutral - Pictures appear more white. • Cool - Pictures appear with a bluish tint. • Custom - Select this option, and then press [ON/OFF] to manually adjust the RGB (red, green, blue) levels. Default levels are set at Neutral.

SETUP MENU

A-5 Reset

Select **Yes** on this sub-menu to reset all Picture-related settings.

English

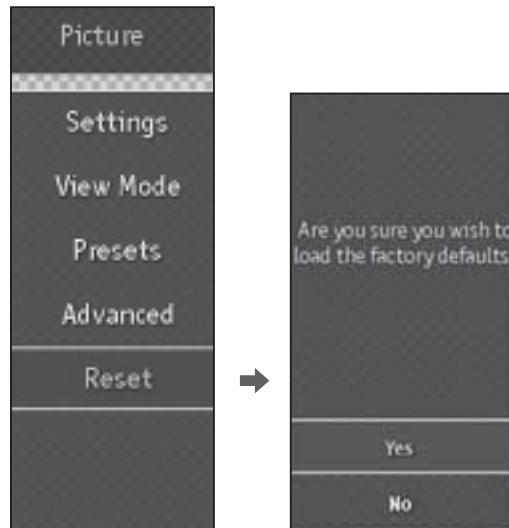

SETUP MENUS

B. AUDIO

Use the Audio sub-menus to configure the audio quality. These settings apply to the LCD TV speakers, not to any connected audio device.

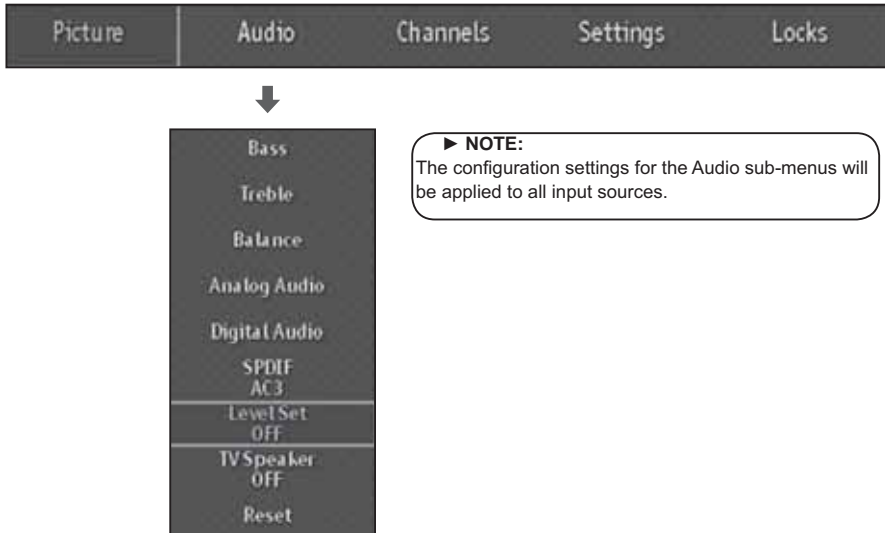

B-1 Bass / B-2 Treble / B-3 Balance

Use these sub-menus to adjust the sound pitch quality and the balance between the L/R speakers.



Press **Enter** to display the option's adjustment bar, then use the **Left/Right** keys to choose your preferred setting.

Audio Aspect	Description
Bass	Calibrate low-pitched sounds.
Treble	Calibrate high-pitched sounds.
Balance	Adjust the sound balance between the L/R speakers.

SETUP MENUS

B-4 Analog Audio

Use this sub-menu to select the preferred audio stream for viewing analog TV programs.

English

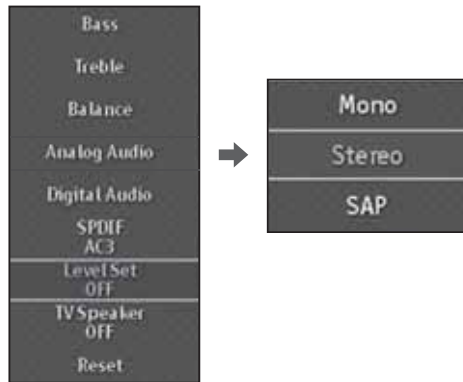

Signal	Description
Mono	Only one of the speaker channels is used to broadcast audio signals (single stream).
Stereo	Both speaker channels are used to broadcast audio signals (L/R streams).
SAP	SAP (Second Audio Program) enables audio signals to be broadcasted in a second language.

B-5 Digital Audio

Use this sub-menu to select the preferred language track for viewing digital TV programs. Available language options will depend on your digital TV provider.

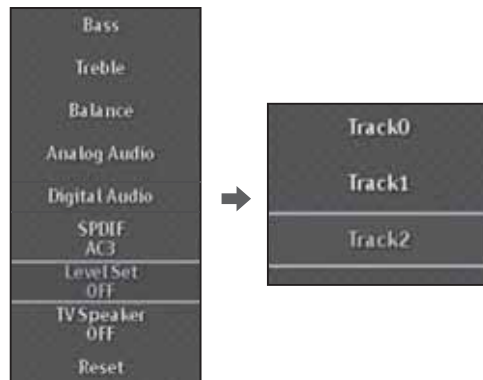

SETUP MENUS

B-6 SPDIF

Use this sub-menu to select the preferred audio format for SPDIF audio signals.



► **NOTE:**
SPDIF is only available when watching DVDs or digital TV.

Press **↔** to cycle between options.

Option	Description
AC3	Surround audio format
PCM	Stereo audio format

B-7 Level Set

Use this sub-menu to select the target inputs to apply the audio settings to.



Press **↔** to cycle between options.

Option	Description
OFF	Audio settings will be retained for all input sources, as well as for both analog and digital TV channels.
ON	Audio settings will be only applied to the input source/ TV signal currently being watched.

SETUP MENUS

B-8 TV Speaker

Use this sub-menu to toggle the LCD TV speakers on and off. Press **OK** to cycle between options.

English



B-9 Reset

Select **Yes** on this sub-menu to reset all Audio-related settings.

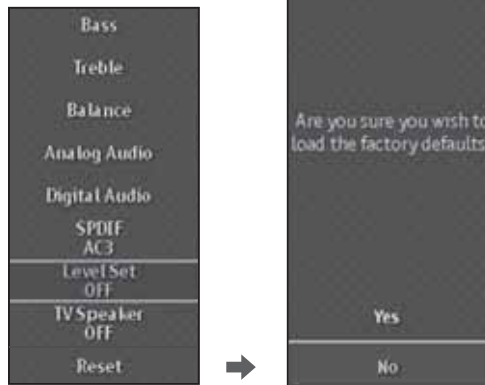

SETUP MENUS

C. CHANNELS

Use the Channel sub-menus to view the channel list and to scan for available TV channels in your area.

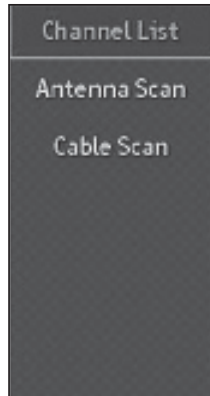

► **NOTES:**

- Make sure the antenna is properly connected to the LCD TV tuner before you access this menu.
- If a system PIN has been set up, you will be prompted to key it in before you can perform an antenna or cable scan.

English

C-1 Channel List

Use this sub-menu to view the list of all available TV channels saved in the unit's memory.

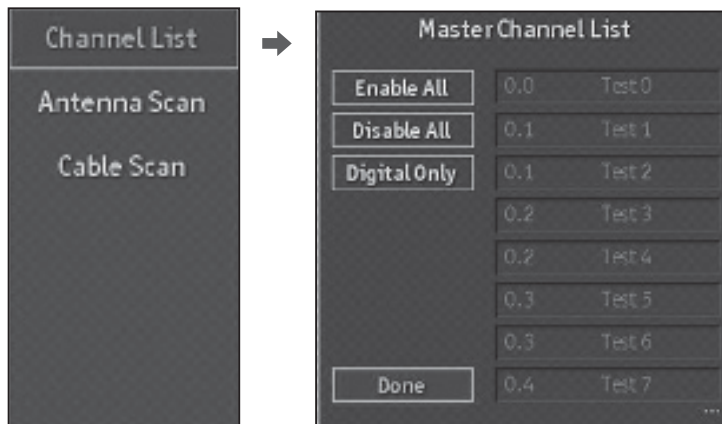

You can choose to enable/disable all available channels or to enable the digital ones only. Use the ◀/▶ keys to select one of the options, select **Done**, and then press ⏪.

SETUP MENUS

C-2 Antenna Scan

Select **Yes** on this sub-menu to scan for available over-the-air and digital channels in your area.

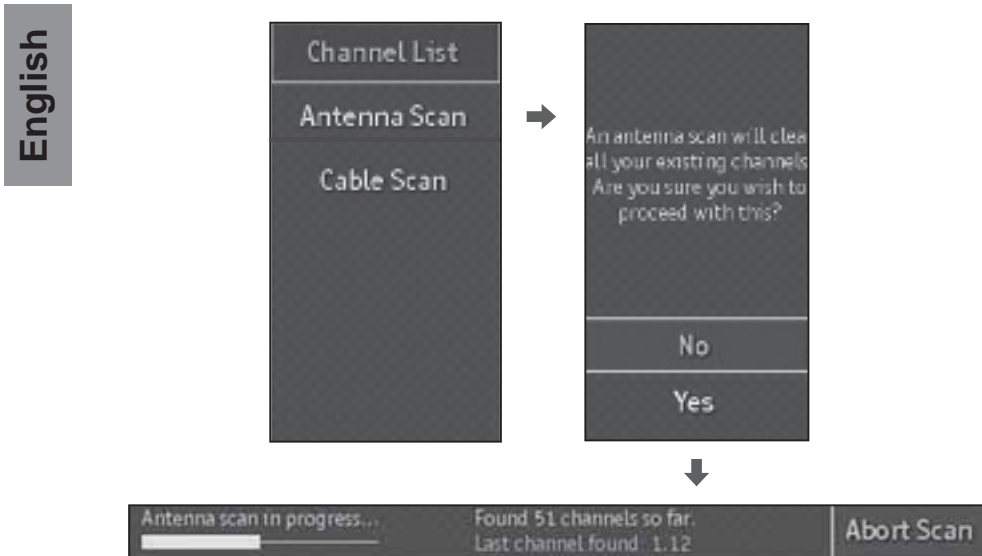

C-3 Cable Scan

Select **Yes** on this sub-menu to scan for available cable and digital channels in your area.

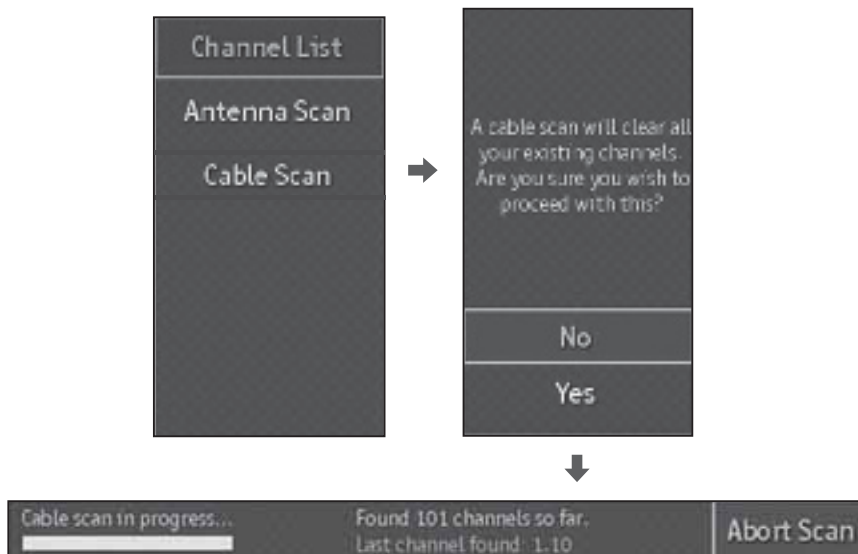

SETUP MENUS

D. SETTINGS

Use the Settings sub-menus to configure the LCD TV operational setup and view the current firmware version.

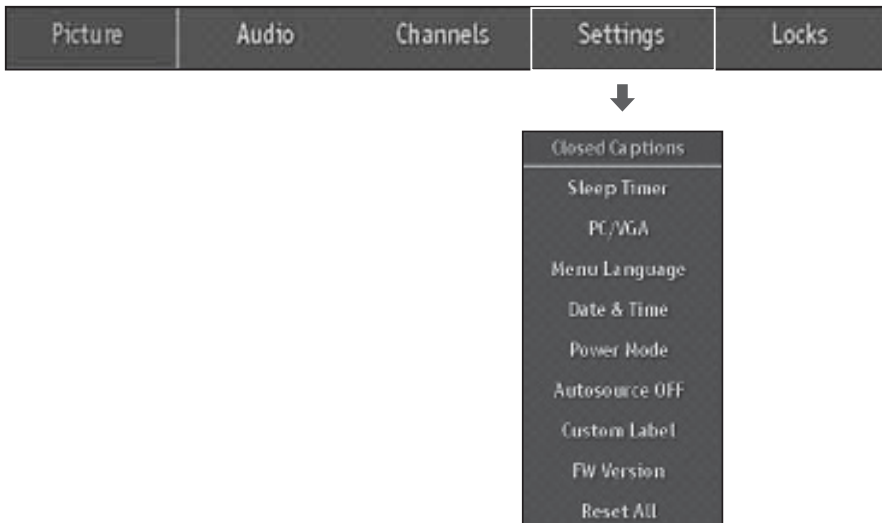

English

D-1 Closed Captions

Use the Closed Captions sub-menus to configure the settings for closed captioning (CC, also known as subtitles) in TV programs. CC are primarily intended to allow people who are deaf or hard of hearing to access TV programs. However, this feature is also useful for viewers who are learning a new language, beginning to read, or in a noisy environment. As the video plays, text captions are displayed that transcribe speech and often other relevant sounds.

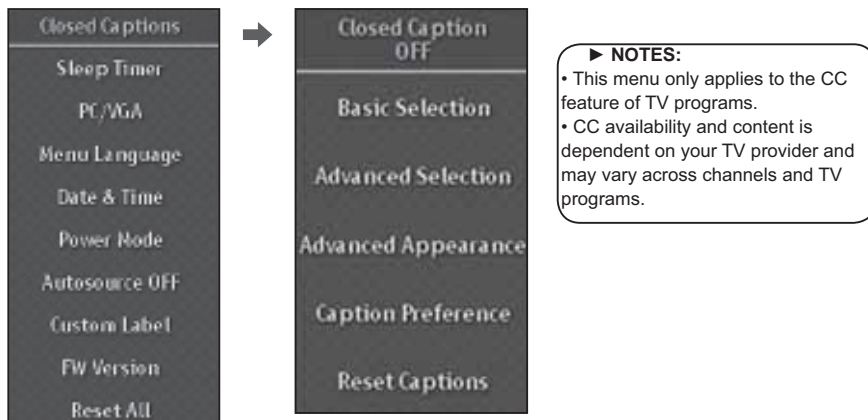

SETUP MENUS

D-1-1 Closed Caption

Use this sub-menu to enable or disable closed captioning in TV programs.

English



➔ Press **↔** to cycle between the OFF and ON settings.

D-1-2 Basic Selection

Use this sub-menu to select the preferred closed captioning content. Most closed caption content can be found within the CC1 setting.

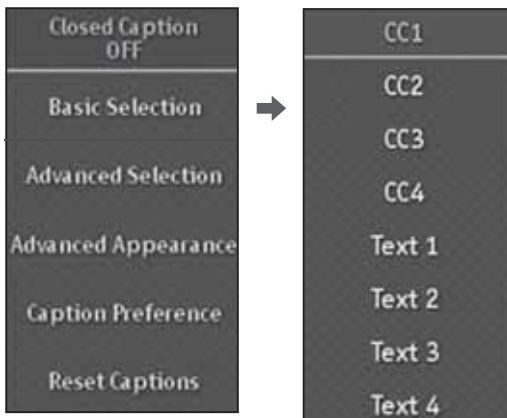

SETUP MENUS

D-1-3 Advanced Selection

Use this sub-menu to select enhanced closed captioning content.

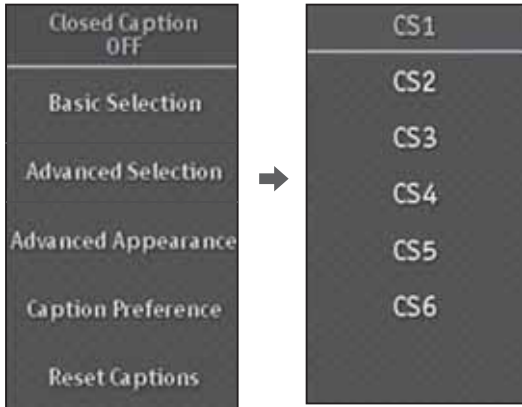

► **NOTE:**
This sub-menu is only available for digital TV programming. The availability is dependent on your digital TV provider and may vary across channels and TV programs.

D-1-4 Advanced Appearance

Use this sub-menu to customized the way closed captions are displayed.

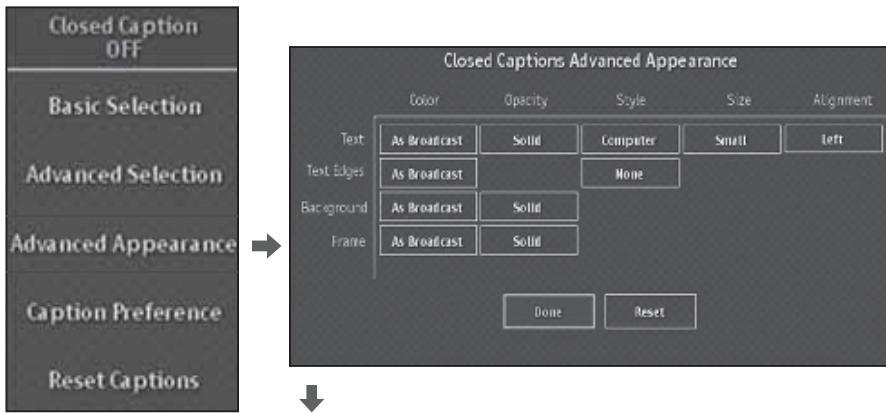



- (1) Use the ◀/▶/▲/▼ keys to select a CC aspect.
- (2) Press **OK** to cycle between the options available for the selected aspect.
- (3) Select **Done**, and then press **OK**.

SETUP MENUS

D-1-5 Caption Preference

Use this sub-menu to select which CC mode to implement for TV programs providing CC content.

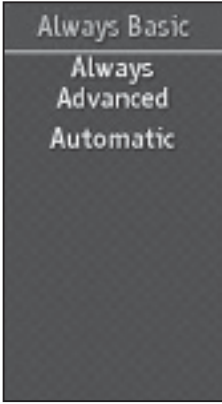
English



- ➔ Use the CC Basic Selection setting.
- ➔ Use the CC Advanced Selection setting.
- ➔ Use the program's default CC content.

D-1-6 Reset Captions

Select **Yes** on this sub-menu to reset all CC-related settings.

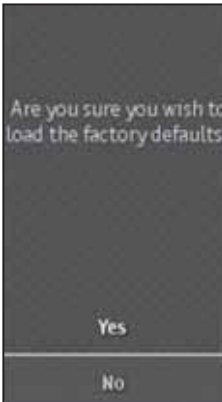

SETUP MENUS

D-2 Sleep Timer

Use this sub-menu to select the duration after which the TV will automatically turn off.

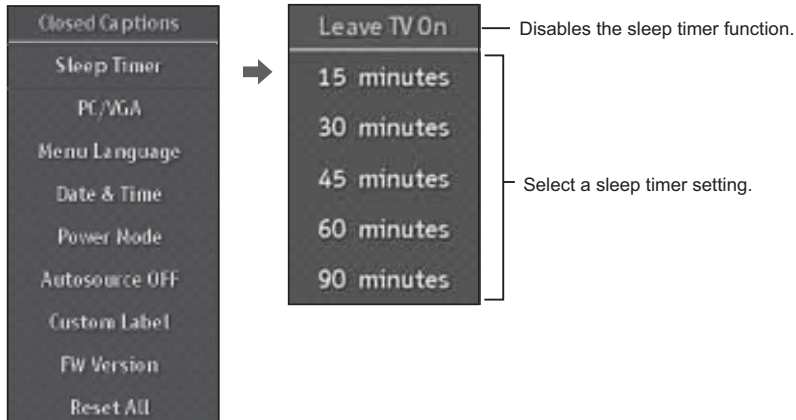

D-3 PC/VGA

Use this sub-menu to configure VGA-related settings applicable when you connect the TV to a computer.

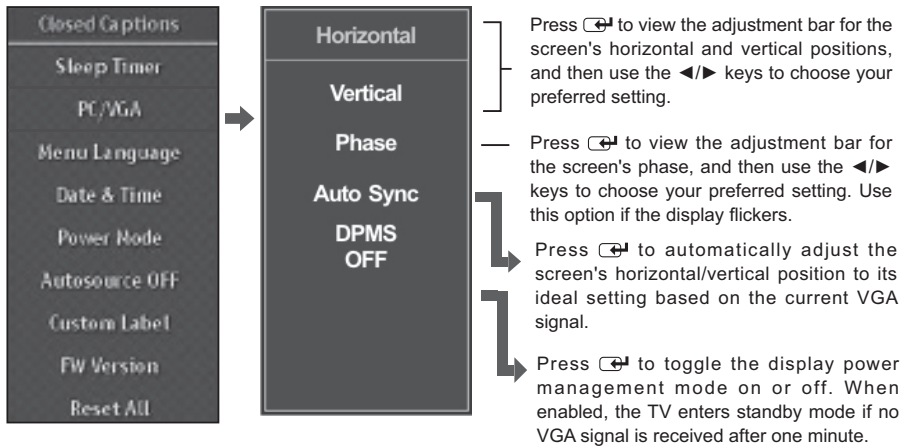

SETUP MENUS

D-4 Menu Language

Use this sub-menu to select which language to use for on-screen menus.

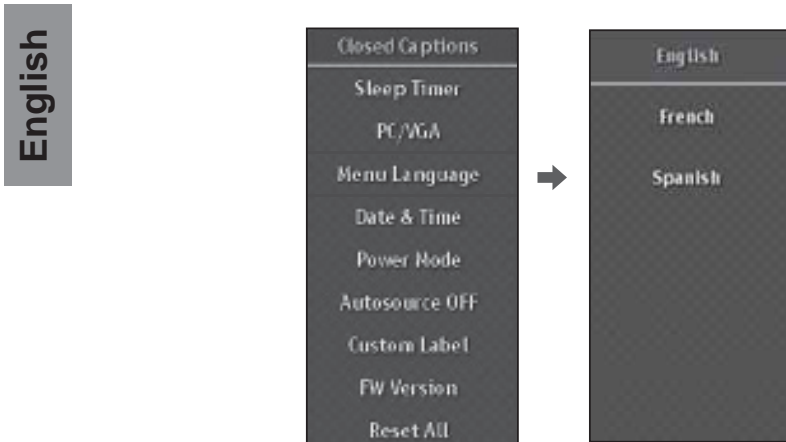

D-5 Date & Time

Use this sub-menu to configure the system clock and time zone settings. You can also choose to enable the Daylight Saving Time (DST) and Auto Update functions.



SETUP MENUS

D-5-1 Set Date / D-5-2 Set Time / D-5-3 Time Zone

Use these sub-menus to configure the system clock and time zone settings.

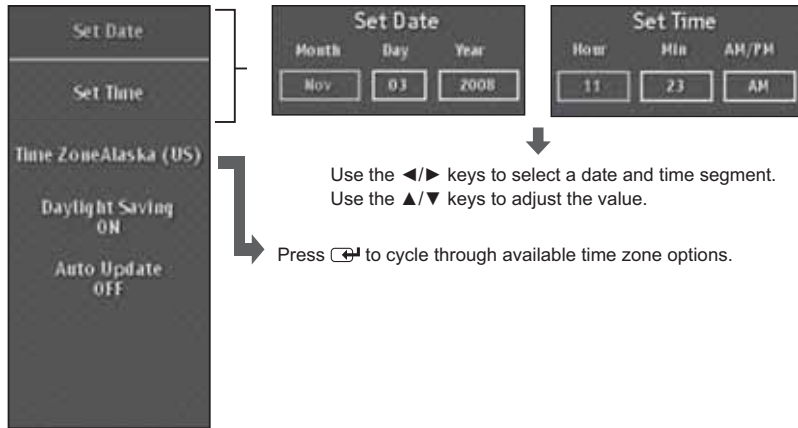

English

► NOTE:

The system date and time settings are not configurable if the Auto Update function is enabled. Clock settings will depend on the TV broadcast stream.

D-5-4 Daylight Saving / D-5-5 Auto Update

Use these sub-menus to toggle the DST and Auto Update functions on or off.

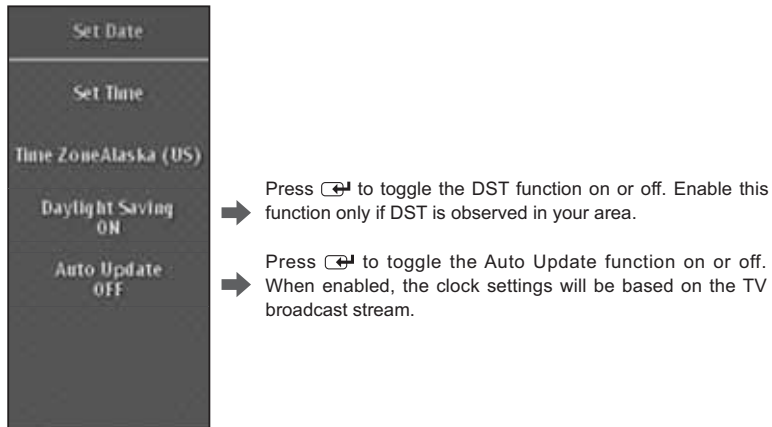

SETUP MENUS

English

D-6 Power Mode

Use this sub-menu to select the LCD TV behavior when it is turned off.



Press **↔** to cycle between options.

Mode	Description
Normal	The TV enters a low-power standby state (backlight is turned off). The TV can be quickly turned on next time.
Energy Saving	All system power is turned off. The TV must be fully booted each time you turn it on.

D-6 Autosource

Use this sub-menu to toggle the Autosource function on or off.

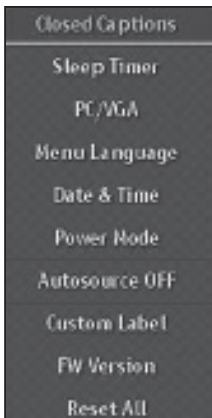

Press **↔** to cycle between options.

Option	Description
ON	The TV will automatically detect and switch to a new input connection (e.g. The TV will automatically switch to PC mode when you connect to your computer.).
OFF	User will need to manually switch to the new input using the Input key or the individual input source keys on the remote control.

SETUP MENUS

English

D-8 Custom Label

Use this sub-menu to assign a device label for each of the input terminals. These labels will be displayed when you press any of the individual input source keys.

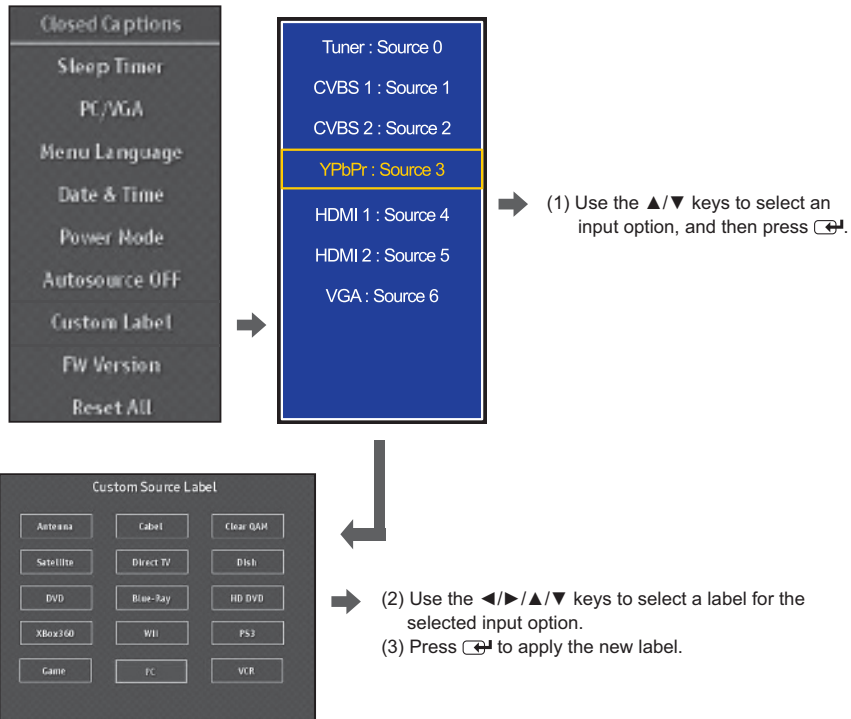

D-9 FW Version

Use this sub-menu to view the firmware version and the current input source.

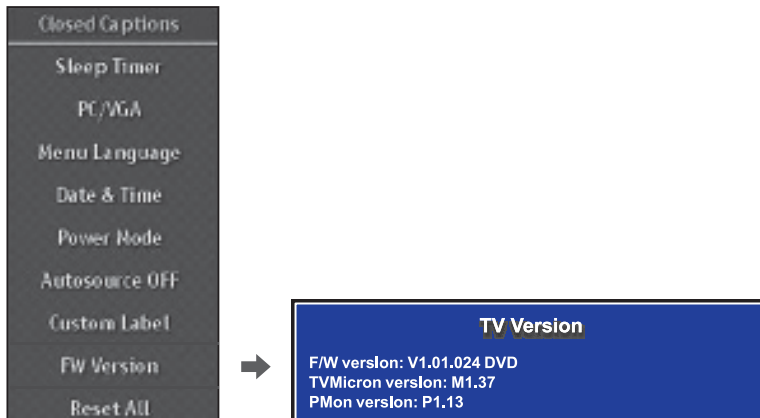

SETUP MENUS

English

D-10 Reset All

Select **Yes** on this sub-menu to reset all LCD TV operational settings. Do this only if any of the following conditions occurs:

- The system fails to respond to the remote control (make sure the remote control batteries are still working and that you are within the transmission range).
- The new configuration settings caused unexpected results.
- You forget the system PIN.



► NOTES:

- If a system PIN was set up earlier, you will be prompted to enter it to access this sub-menu. If you have forgotten your PIN, key in 0000. This is the default PIN.
- After the system reset, the screen will automatically display the Channel List menu. Perform a channel scan to reload the channels to your LCD TV.

E. LOCKS

Use the Locks sub-menus to change the system PIN and set allowable video content for TV programs and DVD titles based on their rating levels.

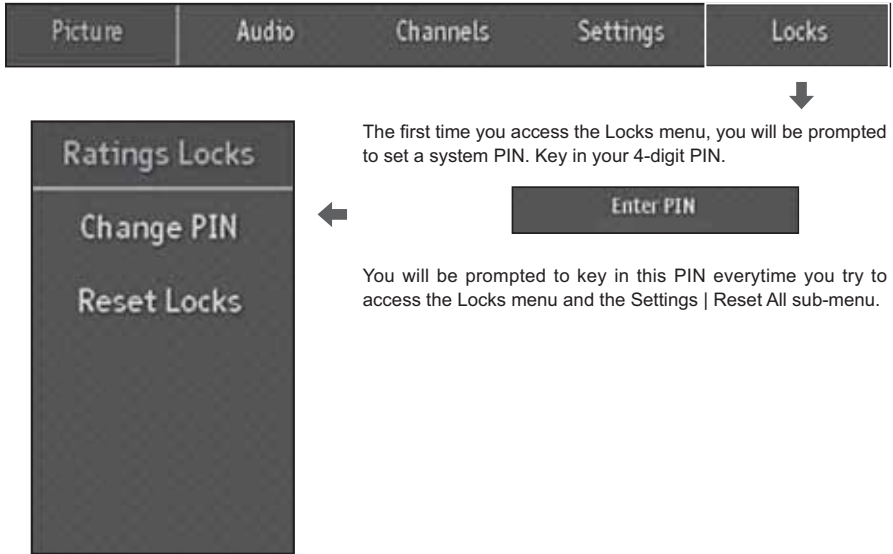

E-1 Ratings Locks

Use this sub-menu to set allowable video content for TV programs (using the TV tuner) based on their rating levels. This will allow users parental control on the kind of TV programs their kids can access.

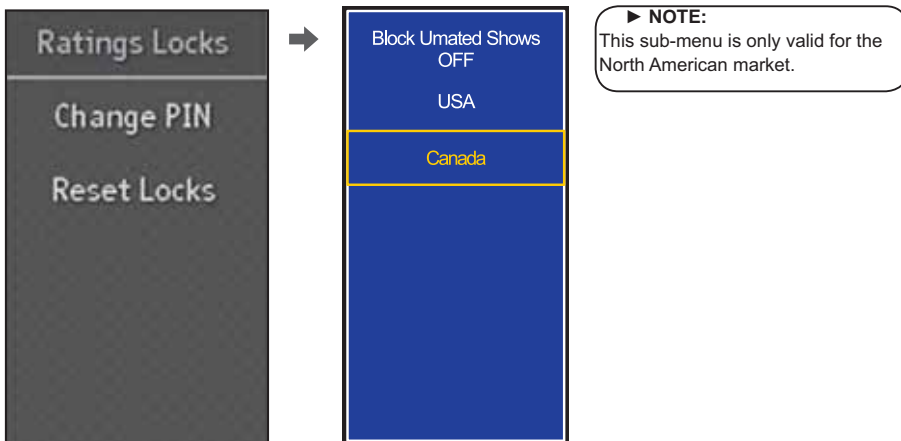

SETUP MENUS

E-1-1 Block Unrated Shows

Use this sub-menu to block viewing of all unrated TV programs.

English



E-1-2 USA

Use this sub-menu to select the rating levels (based on US ratings) of allowable TV programs and movies.

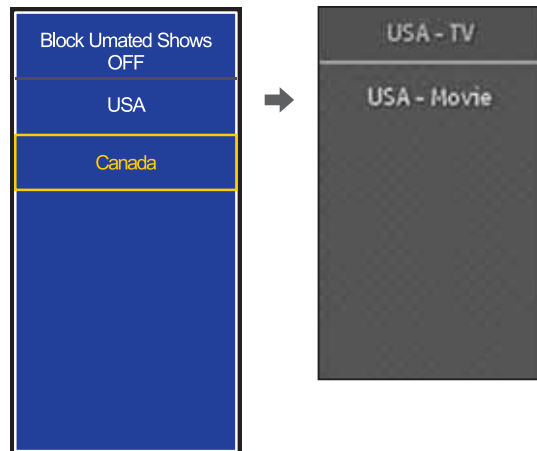

SETUP MENUS

E-1-2-1 USA - TV

Use this sub-menu to select the ratings of allowable TV programs. These ratings are determined by the Federal Communications Commission (FCC).

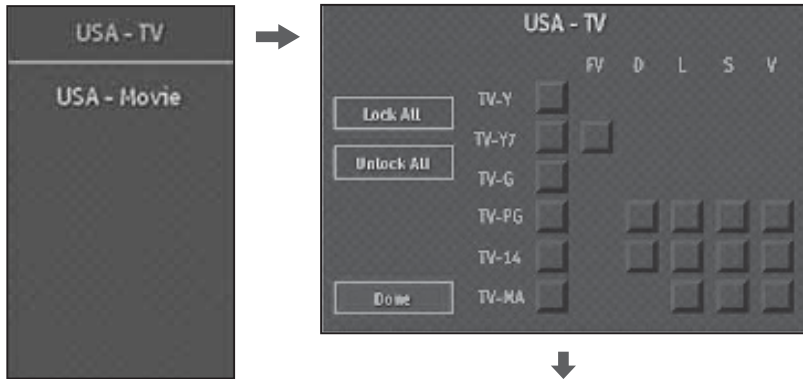

English

- (1) Use the ◀/▶/▲/▼ keys to select a rating box.
- (2) Press **OK** to block TV programs rated as such.
- (3) Select **Done**, and then press **OK**.

Age-based Rating	Content Designation	Description
TV-Y		Suitable for young children
TV-Y7		May not be suitable for children under 7
TV-G		Suitable for all audiences
TV-PG		Parental guidance suggested
TV-14		Parental guidance suggested for children under 14
TV-MA		Suitable for mature audiences only; may be unsuitable for children under 17
	FV	Fantasy violence, combative situations
	D	Suggestive dialogue
	L	Coarse language
	S	Sexual situations
	V	Violence

► **NOTE:**

Selecting a lower age-based rating block takes precedence over content-rating designation.



SETUP MENUS

English

E-1-2-2 USA - Movie

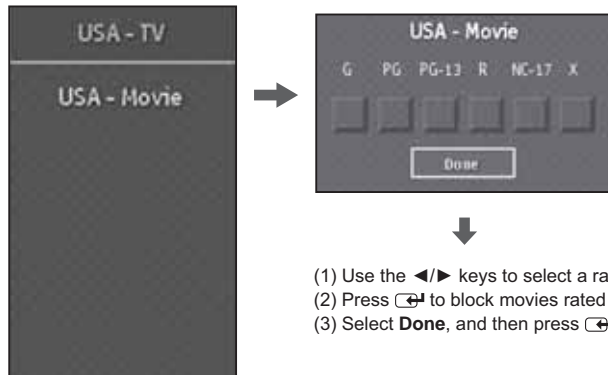
Use this sub-menu to select the ratings of allowable movies. These ratings are determined by the Motion Picture Association of America (MPAA).



- (1) Use the ◀/▶ keys to select a rating box.
- (2) Press  to block movies rated as such.
- (3) Select **Done**, and then press .

Rating	Definition	Content Description
G	General Audience Admitted	Contains nothing most parents will consider offensive for even their youngest children to see or hear; suitable for young children.
PG	Parental Guidance Suggested	May contain some material parents might not like to expose to their young children—material that will clearly need to be examined or inquired about before children are allowed to view the film.
PG-13	Parents Strongly Cautioned	May contain some scenes of drug use; use of one of the harsher sexually-derived words may be heard. May be inappropriate for pre-teens.
R	Restricted	May contain some adult material. Parents are urged to learn more about the film before letting their children view it.
NC-17	No One 17 and Under Admitted	May contain explicit sex scenes, an accumulation of sexually-oriented language, and/or scenes of excessive violence. Suitable for adult audiences only. Rating does not signify that the film is obscene or pornographic.
X	X Rated	Contains extreme violence or explicit sex; suitable for adults audiences only.

SETUP MENUS

E-1-3 Canada

Use this sub-menu to select the classification categories (based on Canadian ratings) of allowable TV programs and movies.

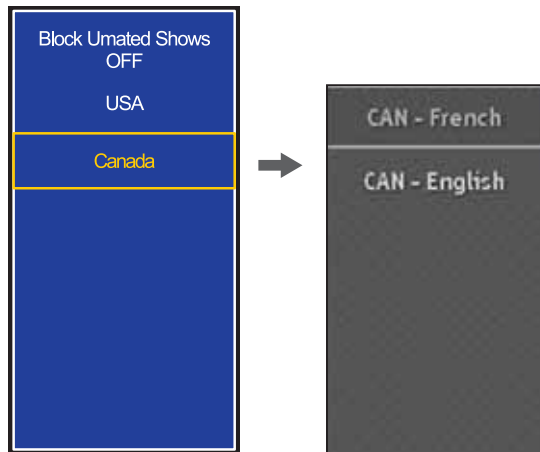

E-1-3-1 CAN - French

Use this sub-menu to select the ratings of allowable TV programs and movies. These ratings are based on the classification categories determined by La Régie du cinéma du Québec.

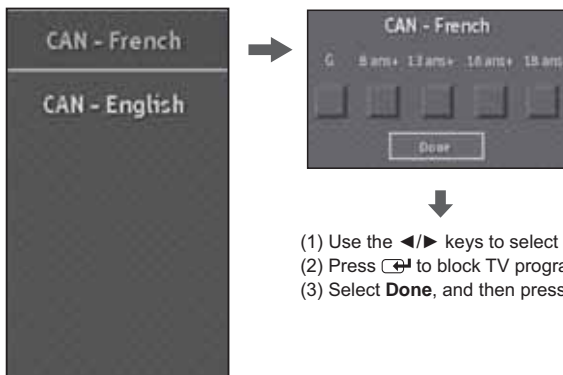

- (1) Use the ◀/▶ keys to select a rating box.
- (2) Press **⏏** to block TV programs and movies rated as such.
- (3) Select **Done**, and then press **⏏**.

Classification	Audience Restriction
G	For general audiences
8 ans+	Not suitable for children under 8 years of age
13 ans+	Not suitable for persons under 13 years of age
16 ans+	Not suitable for persons under 16 years of age
18 ans+	Not suitable for persons under 18 years of age

SETUP MENUS

English

E-1-3-2 CAN - English

Use this sub-menu to select the ratings of allowable TV programs and movies based on the Canadian Home Video Rating System determined by the Canadian Motion Picture Distributors Association (CMPDA).

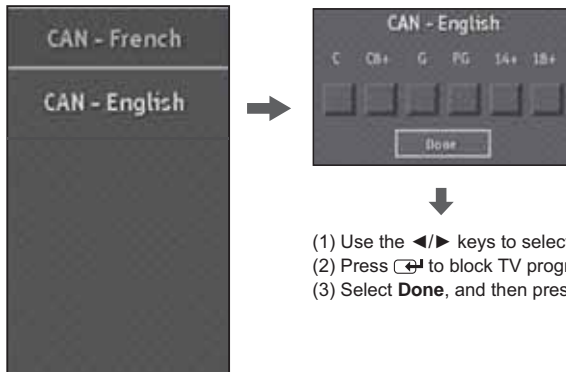

- (1) Use the ◀/▶ keys to select a rating box.
- (2) Press ⏏ to block TV programs and movies rated as such.
- (3) Select **Done**, and then press ⏏.

Classification	Description
C	Suitable for viewing by children of all ages
C8+	Not suitable for children under 8 years of age
G	Suitable for general audiences
PG	Parental guidance advised
14+	Suitable for people 14 years of age or older
18+	Suitable for people 18 years of age or older

E-2 Change PIN

Use this sub-menu to change the system PIN in case the original one has been compromised. You will need to key in the original PIN. If you forget the original PIN, you need to perform the *Reset All* option under the *Settings* sub-menu.

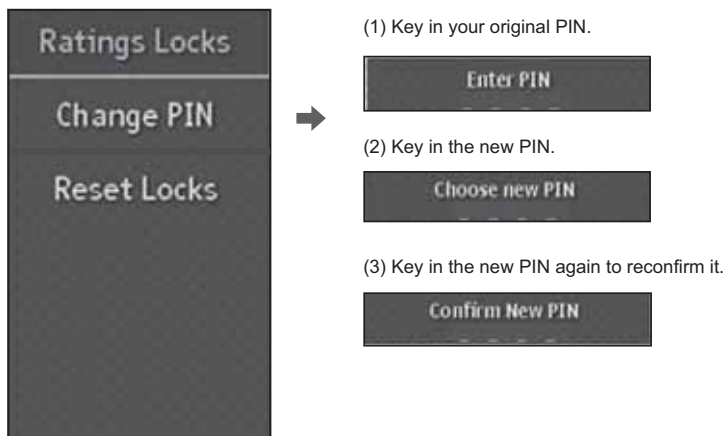

- (1) Key in your original PIN.

- (2) Key in the new PIN.

- (3) Key in the new PIN again to reconfirm it.

SETUP MENUS

E-3 Reset Locks

Select **Yes** on this sub-menu to reset the system PIN and all parental lock settings to their default unlock status.

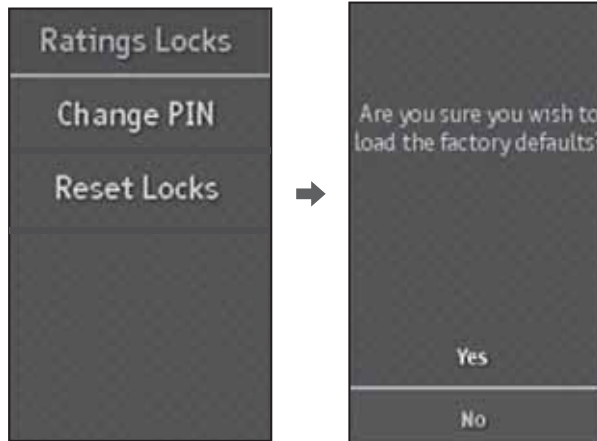

English

SPECIFICATIONS

English

Item	Specification	
Model Name	SK-32H540S	
Panel	Type	32-inch Active Matrix WXGA TFT LCD
	Viewing angle	176° (H) / 176° (V)
	Resolution	1366 x 768 (RGB vertical stripe)
	Color	16.7 million
Audio/Video Input Terminals	<ul style="list-style-type: none"> • VGA (75 ohms, 0.7 Vp-p) + PC audio-in (mini-stereo) H/V separated (TTL) for PC; fh: 30-63 kHz, fv: 50-75 Hz • HDMI 1 and HDMI 2 + RCA (L/R) stereo • TV tuner • YPbPr 1 + RCA (L/R) stereo • Composite 1 and Composite 2 + two RCA (L/R) stereos 	
Audio/Video Output Terminals	<ul style="list-style-type: none"> • RCA (L/R) stereo • SPDIF (optical) 	
Speaker Output	9W (2 channels)	
Image Processor	ATI Xilleon™ 241	
TV System Support	NTSC and ATSC	
TV Compatibility	480i, 480P, 720P, 1080i	
PC Compatibility	Recommended (reduced blanking)	1360 x 768 @ 60 Hz 1366 x 768 @ 60 Hz
	Supported H = 30-63 KHz V = 50-75 Hz	1280 x 720 @ 60 Hz 1024 x 768 @ 60 Hz 720 x 400 @ 70 Hz 640 x 480 @ 60, 75 Hz
Power Voltage	120 VAC, 60 Hz, 3A	
Power Consumption (DC)	On	<190W (blue illumination)
	Off in normal mode	Autowake is enabled: < 23W
	Off in energy saving mode	Autowake is disabled: < 2W
	Power saving mode	Autowake is on: < 6w (amber illumination)
Preset Timing Mode	Pre-adjusted to reduce blanking: 1366 x 768 @ 60 Hz	
Operating Conditions	Temperature	15 to +35°C (humidity < 75%)
	Relative humidity	20 to 90% non-condensing (Ta < 35%)
	Altitude	0 to 2,000 m
Storage Conditions	Temperature	-20 to +60°C (humidity < 35%)
	Relative humidity	10 to 90% non-condensing
	Altitude	0 to 12,000 m
Physical Specifications	Dimensions (W x D x H)	With base: 798 x 200 x 608 mm Without base: 798 x 180 x 556 mm
	Weight (net)	With base: 14.51 kg Without base: 13.1 kg
Regulations	UL/C-UL and FCC-B	
<p>► NOTES:</p> <ul style="list-style-type: none"> • These product specifications are subject to change without user notification. • Do not set your computer graphics card to exceed the unit's refresh rates; doing so may cause damage to the HDTV. 		

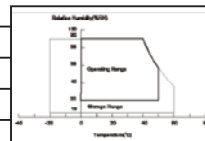

TROUBLESHOOTING

Problem	Corrective Action
No power	<ul style="list-style-type: none"> • Make sure the power indicator is illuminated blue. • Make sure the power cord is securely connected to the AC-in jack and is plugged into a functional AC outlet. You may want to plug in another electrical device to the power outlet to verify that it is supplying the proper voltage.
Power is suddenly turned off	Press ⏻ and select <i>Settings Sleep Timer</i> to make sure the Leave TV On option is selected.
Forgotten PIN	<ol style="list-style-type: none"> (1) Press ⏻ and select <i>Settings Reset All</i>, and then Yes. (2) Access the setup screen again and select Locks. (3) Key in and reconfirm your new PIN.
Remote control does not work	<ul style="list-style-type: none"> • Press only one button at a time. • Make sure the batteries are properly inserted. • The batteries may already be drained out. Replace batteries with new ones.
Remote control code cannot be detected by a universal remote	<ul style="list-style-type: none"> • Purchase a separate learning remote control. • Go to www.wde.com for a list of remote codes.
No picture	<ul style="list-style-type: none"> • Make sure the video input cable is properly connected to the correct terminal, and that the correct input mode is enabled. To illustrate, when a VGA cable is connected to display a computer screen, the PC input mode must be enabled. • In TV mode, verify that the antenna is properly connected and that the preferred channel is enabled in the channel list. Press ⏻ and select <i>Channels Channel List</i>. • Press ⏻ and select <i>Picture</i> to adjust the display settings. • If you are using a Macintosh computer older than a G3 model, you need a Macintosh adapter.
No picture or the <i>No Signal</i> message appears when a VGA cable is connected	<ul style="list-style-type: none"> • Make sure the VGA cable is properly connected to the LCD TV's VGA port. • Decrease the video resolution setting on the computer and try again. • Press ⏻ and select <i>Picture</i> to adjust the display settings. • Press ⏻ and select <i>Settings PC/VGA</i> to adjust the VGA settings. • Decrease the video resolution setting on the computer and try again.
Picture is cut off or appear in a sidebar screen	<ul style="list-style-type: none"> • Press ↔ and make sure the Standard option is selected. • In PC mode, press ⏻ and select <i>Settings PC/VGA</i>, and adjust the Horizontal and Vertical settings.
Poor image quality in TV mode (cutoff picture, snowy images)	<ul style="list-style-type: none"> • Check your antenna connection. If necessary, rotate the antenna and wait up to ten seconds for a signal. • Reduce signal splitters and excessively long cables. • Replace poor antenna cables and/or connectors to improve signal quality. • Press ↔ and make sure the Standard option is selected. • Press ⏻ and select <i>Picture Advanced</i>, and then adjust the Noise Reduction setting. • In HDMI mode, make sure the external device is compatible with the LCD TV.
Wrong, abnormal or missing colors	<ul style="list-style-type: none"> • If any colors (red, green or blue) are missing, check the video cable to make sure it is securely connected. Loose or broken pins in the cable connector could cause an improper connection. • Press ⏻ and select <i>Picture Settings</i> to adjust the Hue and Saturation settings. You can also select <i>Picture Advanced</i> to adjust the Color Temperature settings. • Connect the TV to another computer and check if the problem is with the computer screen.
No sound	<ul style="list-style-type: none"> • Make sure the audio input cable is properly connected to the correct terminal, and that the correct input mode is enabled. • The volume may be muted, press ⏻ or the Vol+ key to turn on the volume on. • Press ⏻ and select <i>Audio</i> to adjust the Bass, Treble, and Balance settings. • If you are using the TV speakers, press ⏻ and select <i>Audio</i> to make sure the TV Speakers option is set to On. • If you are using an external audio device, press ⏻ and select <i>Audio</i> to make sure the TV Speakers option is set to Off. After which, make sure volume on the external audio device is turned on.
<p>► NOTE: If the problem condition persists even after performing the recommended corrective actions, contact us by:</p> <ul style="list-style-type: none"> • Logging on to www.wde.com • Contacting the Westinghouse Customer Service at (866) 287-5555 or e-mail us at service@wde.com 	

APPENDIX A - LCD TV BASE REMOVAL

If you intend to repack the LCD TV unit (for shipping or storage) or you want to change the installation to a wall mount option, you must first remove the LCD TV base.

IMPORTANT:

The LCD TV has VESA FPMPLI compliant 200 x 200 mm mounting holes. Be sure to follow the operating instructions supplied with the wall mount bracket when installing the unit. It is recommended that you employ qualified contractors for wall mount installation.

- (1) Turn off the LCD TV and all connected devices.
- (2) Disconnect the power cord from the LCD TV.
- (3) Disconnect all signal cables from the I/O port terminals.
- (4) Lay the LCD TV on a clear, flat, and stable surface.

CAUTION:

The LCD TV unit maybe too heavy for one person to lift. If this is the case, make sure to ask assistance in handling the LCD TV to prevent physical injury and/or damage to unit.

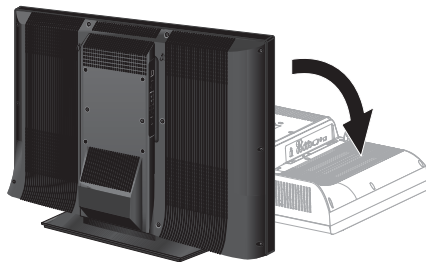

- (5) Remove the four screws securing the base to the LCD TV.
- (6) Detach the base from LCD TV.

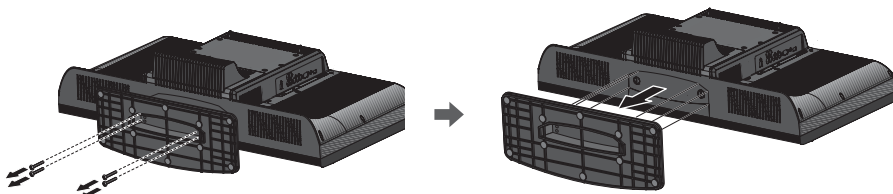

- (7) Pack the screws you removed in step 7 together with the LCD TV base for future reassembly.

APPENDIX B - SAFETY BRACKETS

You can use the safety brackets located on the LCD TV's spine module cover to protect the unit from accidentally tipping over or from unwanted theft.

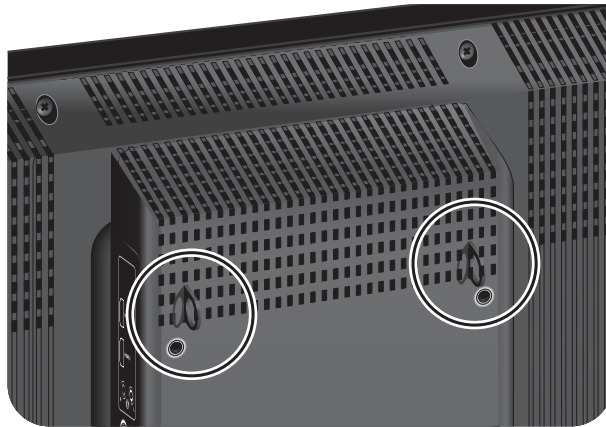

English

1. ANTI-TIPPING MECHANISM

You can use the safety brackets to anchor the LCD TV in place by looping a security cable through the brackets and securing it to a surface that is strong enough to support the weight of the unit. Using the safety brackets in this manner does not preclude the use of the LCD TV base. ***The safety brackets must be used in conjunction with the unit base.*** The brackets are only to be used as an additional safety option.

2. ANTI-THEFT PROTECTION

The safety brackets can also be used to protect the LCD TV from unwanted theft by looping a security cable through the brackets and bolting it to an immovable surface.

APPENDIX C - WALL MOUNT OPTION

The LCD TV has been fitted with VESA FPMPMI compliant mounting holes. These 200 x 200 mm mounting holes allow the unit to be mounted on a wall.

English

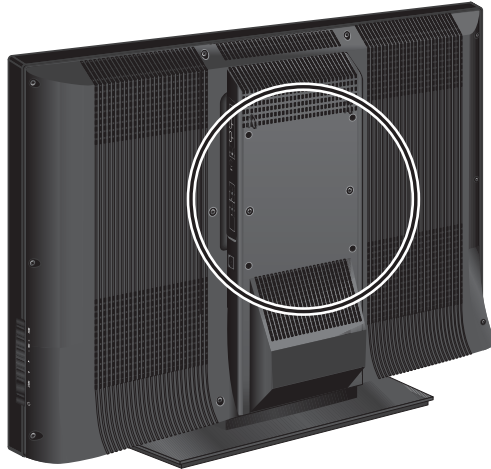

IMPORTANT:

Remove the LCD TV base first before mounting the unit on a wall. Go to page 54 for related instructions. It is the user's responsibility to use a UL listed wall mount unit rated to support the weight of this LCD TV. Please consult qualified contractors for wall mount installation. The incomplete or improper mounting of this unit to a wall may cause it to fall down resulting to property damage and/or potentially serious injury.

Free Manuals Download Website

<http://myh66.com>

<http://usermanuals.us>

<http://www.somanuals.com>

<http://www.4manuals.cc>

<http://www.manual-lib.com>

<http://www.404manual.com>

<http://www.luxmanual.com>

<http://aubethermostatmanual.com>

Golf course search by state

<http://golfingnear.com>

Email search by domain

<http://emailbydomain.com>

Auto manuals search

<http://auto.somanuals.com>

TV manuals search

<http://tv.somanuals.com>