



Westinghouse

# WIRELESS INTERCOM SYSTEM

## 5-CHANNEL RADIO INTERCOM

Models: WHDBI-5C (One Console & One Doorbell)

WHI-5S (One Console)

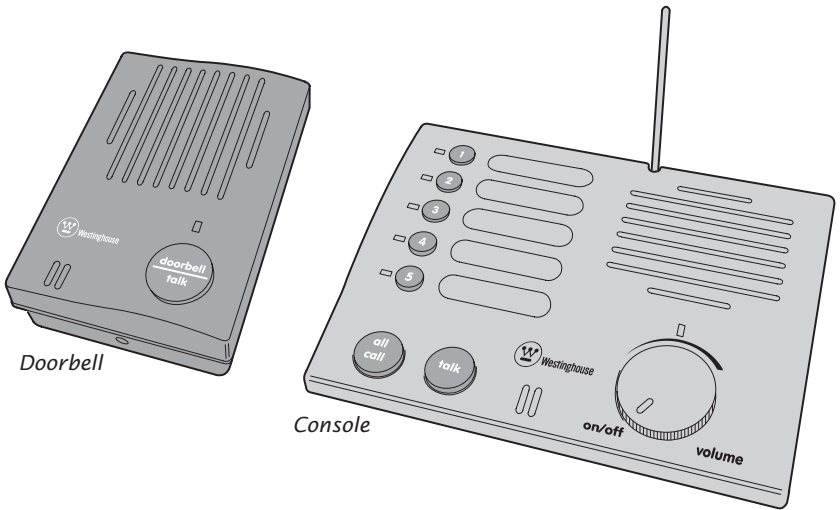

Doorbell

Console

## Installation & Operation Instructions

# Linear®

(760) 438-7000 • FAX (760) 438-7043  
USA & Canada (800) 421-1587 & (800) 392-0123  
Toll Free FAX (800) 468-1340  
[www.linearcorp.com](http://www.linearcorp.com)

Download from [www.Somanuals.com](http://www.Somanuals.com). All Manuals Search And Download.

## ***TABLE OF CONTENTS***

---

CONSOLE FEATURES .....	1
DOORBELL FEATURES .....	2
PREPARE CONSOLE & ANTENNA .....	3
WALL MOUNTING THE DOORBELL .....	4
WALL MOUNTING THE CONSOLE .....	5
OPERATING THE DOORBELL & CONSOLE .....	6
OPERATING MULTIPLE CONSOLES .....	7
CALLING MULTIPLE CONSOLES .....	8
ADJUSTING THE DOORBELL'S VOLUME .....	9
CHANGING A CONSOLE'S SETTINGS .....	10
CHANGING A DOORBELL'S SETTINGS .....	11
TROUBLESHOOTING .....	12
IMPORTANT FCC NOTICE .....	13

## ***CONSOLE DESCRIPTION***

---

The 5-channel Wireless Intercom Consoles provide a wireless audio communication link between up to five Console stations and one or two remote Wireless Doorbell Intercom units.

The intercom uses digital signals to control the stations called and provide a unique "house code" that prevents other nearby intercoms from accessing the system. Either of two radio frequencies can be selected for the intercoms to further eliminate the chance of interference from adjacent systems.

The Console features five station number pushbuttons for selecting the party to call. The ALL CALL button can be used to call all stations. Pressing the TALK button calls the selected station, then controls the direction of the conversation. Each intercom user presses their TALK button to activate the microphone during the conversation.

The Doorbell works as Console station 4 or 5. Pressing the Doorbell's TALK button sounds a "ding-dong" (station 5), or "dong" (station 4) at the Console, then the conversation begins by pressing the units' talk buttons.

For privacy, a MUTE switch on each Console can be set to prevent Wireless Doorbell tones and ALL CALL messages from sounding through that Console's speaker.

The Console can be placed on a table or shelf, or mounted to a wall with the screws provided. The antenna adjusts for table or wall mounting. Power for the Console is provided by a plug-in transformer.

The Doorbell attaches to a wall with the mounting plate provided. Two 9-volt alkaline batteries power the Doorbell intercom.

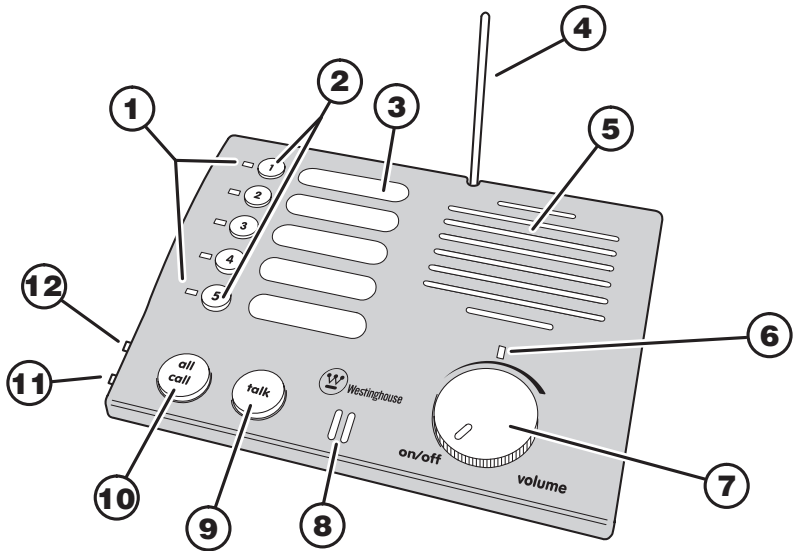

## 1. STATION INDICATORS

Indicators light when a station number button is pressed to show the station that will be called. Indicators light to show who called or a call in progress. Indicators flash during conversation to show the busy stations.

## 2. STATION BUTTONS

Press a button to select the intercom station to be called.

## 3. STATION LABEL AREAS

For applying labels that identify the intercom station locations.

## 4. ANTENNA

Receives and sends the wireless intercom signals. Antenna pivots for Console horizontal and vertical mounting.

## 5. SPEAKER

Sounds audio from the calling station. Volume is adjustable with the volume control.

## 6. POWER INDICATOR

Lights to show that Console power is switched on.

## 7. VOLUME CONTROL - POWER SWITCH

Switches Console power ON & OFF. Adjusts the volume of the Console's speaker.

## 8. MICROPHONE

High-gain microphone monitors audio from the calling station while the Console's TALK button is pressed.

## 9. TALK BUTTON

Press and hold to talk to the selected station.

## 10. ALL CALL BUTTON

Press and hold to talk to all stations.

## 11. MUTE SWITCH

When ON, the Console will **not** sound Doorbell Intercom chime tones or respond to All Call signals.

## 12. FREQUENCY SWITCH

Selects frequency A or B. All intercoms used in the same system **must** be set to the same frequency.

# DOORBELL FEATURES

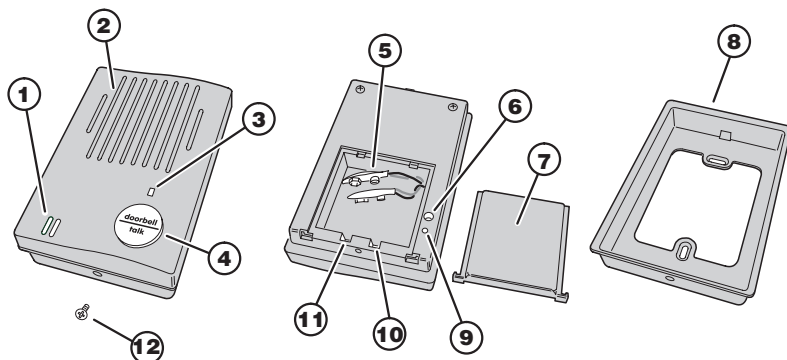

## 1. MICROPHONE

High-gain microphone monitors audio while the Doorbell's TALK button is pressed.

## 2. SPEAKER

Sounds audio from the intercom Console. Volume is adjustable with the volume control (see Item #6).

## 3. POWER INDICATOR

Lights to show that Doorbell power is on. Doorbell power automatically switches ON when TALK button is pressed. The power automatically switches OFF 25 seconds after the last intercom communication.

## 4. DOORBELL-TALK BUTTON

Press to turn ON the Doorbell power and sound the chime at all of the intercom Consoles (Consoles with their MUTE switch ON will not sound the Doorbell chime). During intercom conversation, press and hold the DOORBELL-TALK button while speaking.

## 5. BATTERY CLIPS

For connection to two 9-volt *alkaline* batteries.

## 6. VOLUME CONTROL

Sets the volume level of the Doorbell's speaker.

## 7. BATTERY DOOR

Slides off rear case to expose the battery compartment, FREQUENCY switch, and STATION switch.

## 8. MOUNTING PLATE

Mounts the Doorbell to a wall or single-gang outlet box.

## 9. PROGRAM BUTTON

Press to cause the Doorbell to enter program mode.

## 10. FREQUENCY SWITCH

Sets the Doorbell to frequency "A" or "B". All intercoms used in the same system *must* be set to the same frequency.

## 11. STATION SWITCH

Sets the Doorbell to station 4 or 5. When set for station 5, the Doorbell will sound a "ding-dong" chime at the Console. When set for station 4, the Doorbell will sound a "dong" chime at the Console.

## 12. CASE LOCKING SCREW

Secures the Doorbell to the mounting plate.

# PREPARE CONSOLE & ANTENNA

## 1 PREPARE THE ANTENNA

SWING ANTENNA  
OUT FROM BOTTOM  
OF CASE

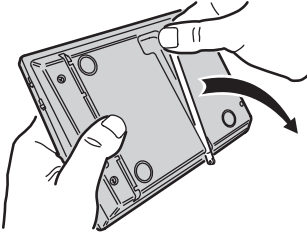

SWING ANTENNA  
ALL THE WAY UP

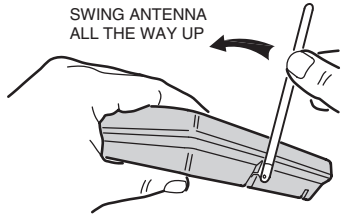

FOR TABLE OR SHELF MOUNTING...

POINT ANTENNA  
STRAIGHT UP  
FROM CASE

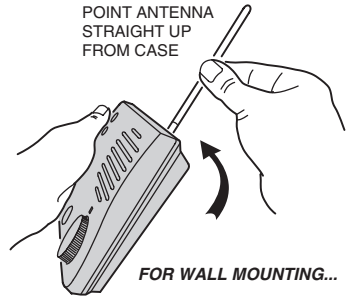

FOR WALL MOUNTING...

## 2 PREPARE CONSOLE AND DOORBELL

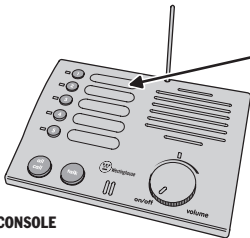

CONSOLE

LABELS ARE SUPPLIED  
TO IDENTIFY STATION  
LOCATIONS

FACTORY SETTING:  
CONSOLE STATION #1  
DOORBELL STATION #5



DOORBELL

PLUG IN  
CONSOLE(S)  
TRANSFORMER

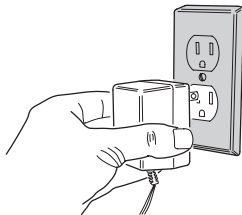

CONNECT  
DOORBELL(S)  
BATTERIES

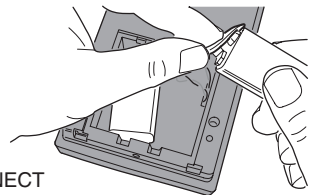

## WALL MOUNTING THE DOORBELL

NOTE: DO NOT MOUNT THE DOORBELL UNIT WHERE IT WILL BE EXPOSED TO EXCESSIVE MOISTURE, DUST, OR IN DIRECT SUNLIGHT

**1**

USE MOUNTING PLATE AND PENCIL TO MARK SCREW LOCATIONS

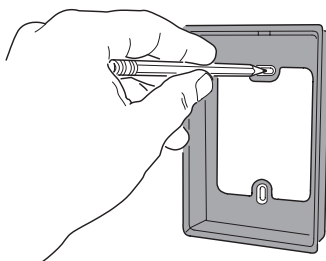

**2**

ATTACH MOUNTING PLATE USING THE SCREWS PROVIDED

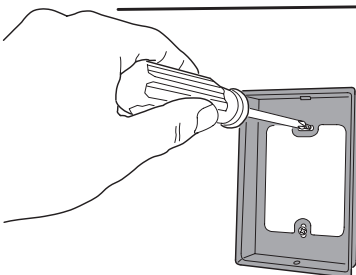

**3**

TILT DOORBELL INTO MOUNTING PLATE

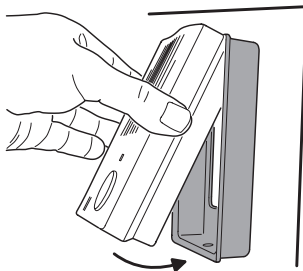

**4**

SECURE DOORBELL TO MOUNTING PLATE WITH THE CASE LOCKING SCREW

NOTE: WAIT UNTIL AFTER ADJUSTING THE DOORBELL AUDIO VOLUME BEFORE FULLY TIGHTENING THE LOCKING SCREW

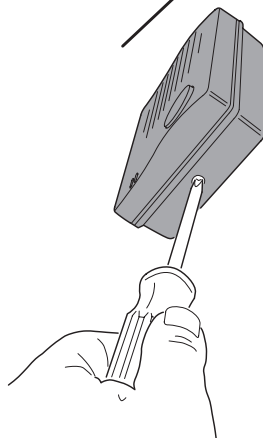

# WALL MOUNTING THE CONSOLE

NOTE: DO NOT MOUNT THE CONSOLE OUTDOORS, OR WHERE IT WILL BE EXPOSED TO EXCESSIVE MOISTURE, DUST, OR IN DIRECT SUNLIGHT

LEFT SCREW →

ROUTE TRANSFORMER WIRE INTO WIRING SLOT

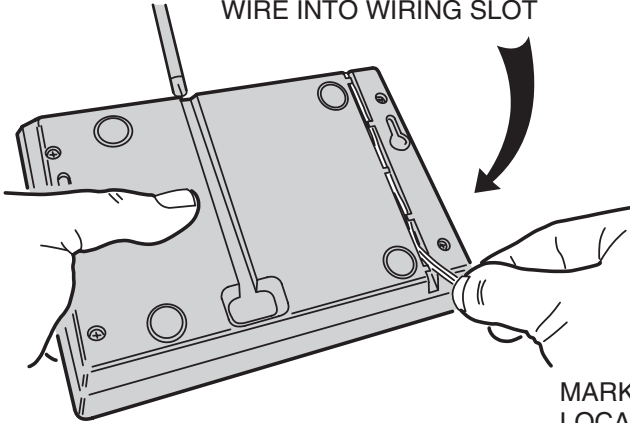

MARK SCREW LOCATIONS AND DRIVE IN SCREWS LEAVING HEADS ABOUT 1/4" OUT

MOUNT CONSOLE ON WALL SCREWS

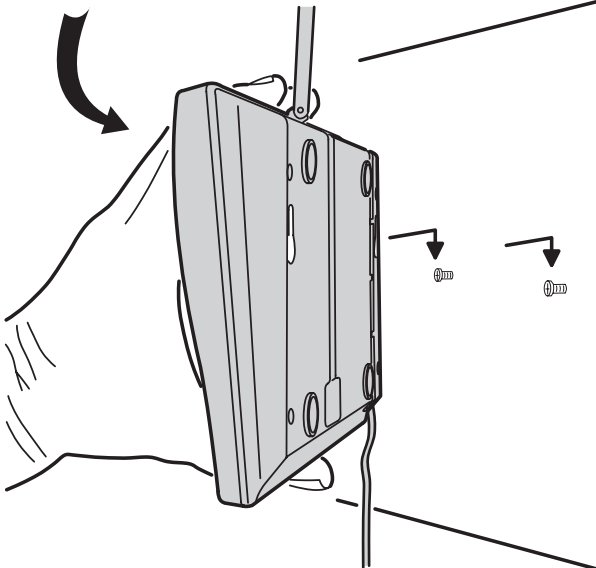

RIGHT SCREW →

# OPERATING THE DOORBELL & CONSOLE

## CALLING A CONSOLE FROM A DOORBELL

EXAMPLE: FRONT DOOR IS CALLING KITCHEN

### 1 THE VISITOR MAKES THE CALL

THE VISITOR PRESSES THE DOORBELL-TALK BUTTON

NOTE: THE CONSOLE POWER MUST BE ON, AND THE VOLUME MUST BE SET ABOVE MINIMUM

GREEN POWER INDICATOR LIGHTS WHILE DOORBELL POWER IS ON

DOORBELL CALLS KITCHEN

FRONT DOOR DOORBELL

### 2 CONSOLE ANNOUNCES THE VISITOR

EACH CONSOLE WILL CHIME A "DING-DONG" (FOR STATION 5, FRONT DOOR) OR A "DONG" (FOR STATION 4, BACK DOOR)

NOTE: IF A CONSOLE'S MUTE SWITCH IS "ON", THE DOORBELL CHIME WILL NOT SOUND

DING!  
DONG!

KITCHEN HEARS DOORBELL CALL

KITCHEN CONSOLE

### 3 SEE THE VISITOR'S LOCATION

THE CONSOLE WILL INDICATE THE DOORBELL STATION THAT CALLED

NOTE: A CONSOLE MUST RESPOND WITHIN 60 SECONDS, OR THE DOORBELL UNIT WILL AUTOMATICALLY SHUT OFF

STATION INDICATOR LIGHTS TO SHOW WHICH STATION CALLED

KITCHEN CONSOLE SHOWS DOORBELL CALL

KITCHEN CONSOLE

### 4 HAVE THE CONVERSATION

RESPOND TO THE VISITOR BY PRESSING & HOLDING THE TALK BUTTON WHILE SPEAKING, RELEASE THE TALK BUTTON AFTER SPEAKING (**WAIT FOR THE BEEP BEFORE SPEAKING**)

THE CONVERSATION GOES BACK AND FORTH, WITH EACH PERSON PRESSING THEIR OWN TALK BUTTON

NOTE: DOORBELLS WILL GO ON STANDBY AFTER 60 SECONDS OF SILENCE

STATION INDICATOR LIGHTS WHILE TALKING & LISTENING

KITCHEN TALKS TO DOORBELL

HELLO  
WHO'S THERE?

KITCHEN CONSOLE



# OPERATING MULTIPLE CONSOLES

## CALLING ONE CONSOLE FROM ANOTHER CONSOLE

EXAMPLE: GARAGE IS CALLING KITCHEN

### 1 CHOOSE WHOM TO CALL

WITH CONSOLE POWER ON, PRESS THE BUTTON FOR THE CONSOLE THAT YOU WANT TO CALL (DOORBELLS CAN NOT BE CALLED)

STATION INDICATOR LIGHTS

GARAGE SELECTS KITCHEN

GARAGE CONSOLE

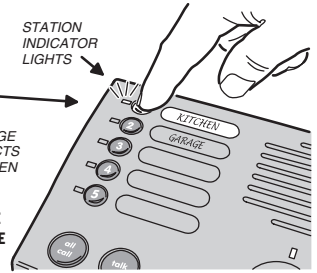

### 2 MAKE THE CALL

PRESS AND HOLD THE TALK BUTTON, WAIT FOR THE BEEP, THEN SPEAK TOWARDS THE CONSOLE

RELEASE THE TALK BUTTON WHEN YOU ARE FINISHED TALKING

STATION INDICATOR STAYS LIT

GARAGE CALLS KITCHEN

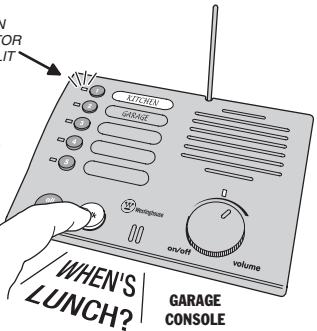

### 3 WAIT FOR RESPONSE

THE CONSOLE CALLED WILL SOUND THE MESSAGE

THE CALLER THEN WAITS FOR THE PERSON TO RESPOND

STATION INDICATOR LIGHTS TO SHOW WHICH STATION CALLED

KITCHEN HEARS GARAGE

KITCHEN CONSOLE

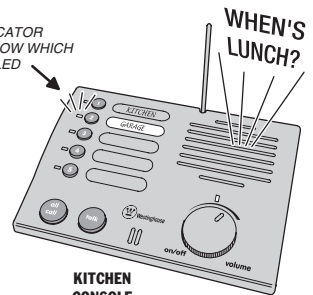

### 4 HAVE THE CONVERSATION

RESPOND TO THE CALLER BY PRESSING & HOLDING THE TALK BUTTON WHILE SPEAKING, RELEASE THE TALK BUTTON AFTER SPEAKING (WAIT FOR THE BEEP BEFORE SPEAKING)

THE CONVERSATION GOES BACK AND FORTH, WITH EACH PERSON PRESSING THEIR OWN TALK BUTTON

NOTE: CONSOLES WILL GO ON STANDBY AFTER 60 SECONDS OF SILENCE

STATION INDICATOR LIGHTS WHILE TALKING & LISTENING

KITCHEN TALKS TO GARAGE

KITCHEN CONSOLE

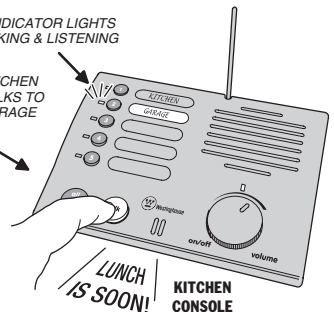

# CALLING MULTIPLE CONSOLES

## CALLING ALL CONSOLES EXAMPLE: KITCHEN IS CALLING EVERYONE

### 1 CHOOSE STATION ALL-CALL

HOLD THE ALL CALL BUTTON, WAIT FOR THE BEEP. SPEAK TOWARDS THE CONSOLE

RELEASE THE ALL CALL BUTTON WHEN YOU ARE FINISHED TALKING

NOTE: ANY CONSOLE WITH ITS MUTE SWITCH ON AND ANY DOORBELL UNITS THAT HAVE NOT BEEN USED IN THE PRIOR 60 SECONDS WILL NOT RECEIVE THE ALL-CALL MESSAGE

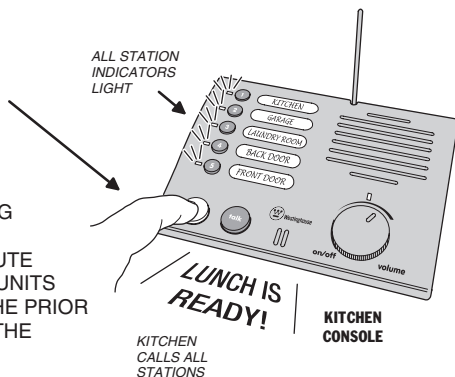

### 2 WAIT FOR RESPONSE

ALL CONSOLES THAT RECEIVED THE ALL-CALL MESSAGE WILL SOUND THE MESSAGE

THE CALLER THEN WAITS FOR A PERSON TO RESPOND

NOTE: THE CONSOLES CALLED HAVE 60 SECONDS TO RESPOND, OR THE CALL WILL BE CANCELED

STATION INDICATOR LIGHTS TO SHOW WHICH STATION CALLED

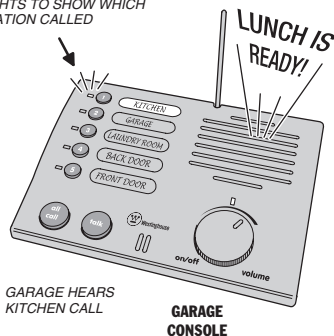

### 3 HAVE THE CONVERSATION

RESPOND TO THE CALLER BY PRESSING & HOLDING THE ALL CALL BUTTON WHILE SPEAKING, RELEASE THE ALL CALL BUTTON AFTER SPEAKING (WAIT FOR BEEP BEFORE TALKING)

THE CONVERSATION GOES BACK AND FORTH, WITH EACH PERSON PRESSING THEIR OWN ALL CALL BUTTON

CONSOLES WILL GO ON STANDBY AFTER 60 SECONDS OF NO TALKING

STATION INDICATOR LIGHTS WHILE TALKING AND LISTENING

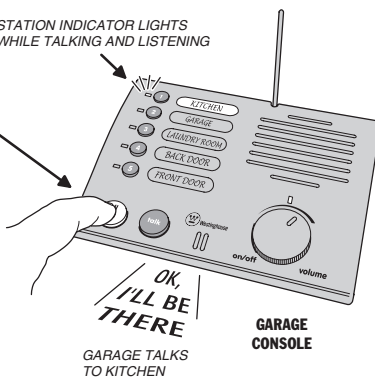

## ADJUSTING THE DOORBELL'S VOLUME

THE DOORBELL'S VOLUME  
CAN BE ADJUSTED TO  
SUIT THE INSTALLATION

HAVE SOMEONE TALK TO  
THE DOORBELL FROM THE  
CONSOLE WHILE ADJUSTING  
THE DOORBELL'S VOLUME

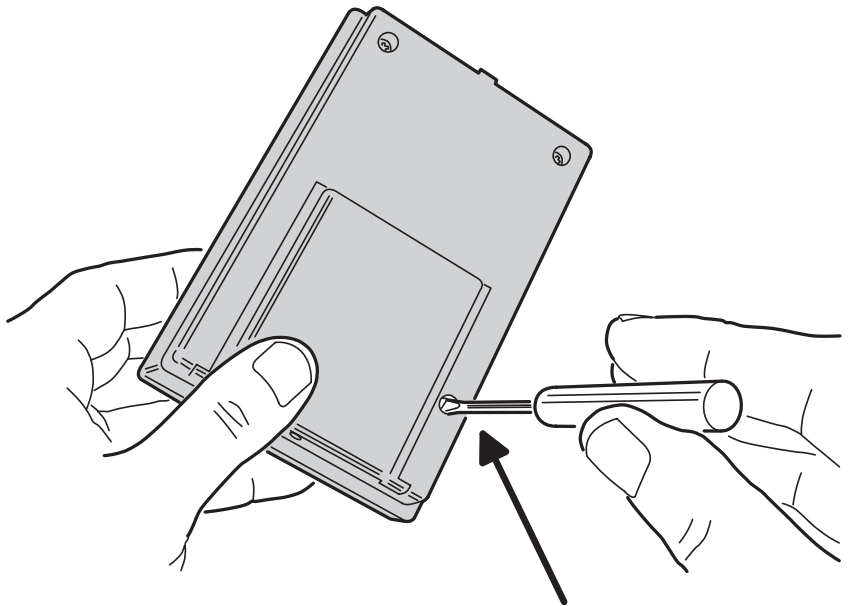

USE A SMALL SCREWDRIVER  
TO ADJUST THE VOLUME  
CONTROL

DOORBELL  
VOLUME



# CHANGING A CONSOLE'S SETTINGS

## 1 TO CHANGE A CONSOLE OR ADD A NEW CONSOLE, PREPARE THE CONSOLE FOR PROGRAMMING

THE FACTORY SETTING FOR THE FREQUENCY SWITCH IS "A", SET THE FREQUENCY SWITCHES TO MATCH ON ALL CONSOLES (ALL EITHER "A" OR "B")

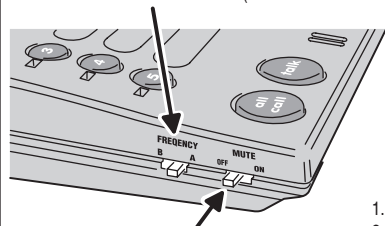

SET THE MUTE SWITCH TO OFF WHILE PROGRAMMING

**NOTE: UNITS ARE PRE-SET AT THE FACTORY WITH THE SAME HOUSE CODE, CHANGING THE HOUSE CODE IS ONLY NECESSARY WHEN ADDING ADDITIONAL UNITS OR TO AVOID OVERLAP WITH OTHER SYSTEMS**

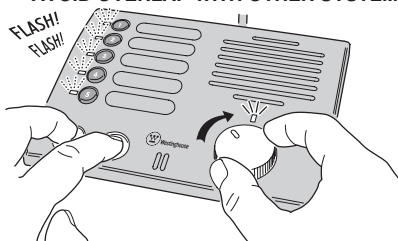

1. START WITH THE POWER OFF (VOLUME KNOB OFF)
2. PRESS & HOLD DOWN "ALL CALL" & "TALK" BUTTONS
3. TURN POWER ON (TURN VOLUME KNOB ON HALFWAY)
4. WHEN ALL STATION LIGHTS FLASH, RELEASE THE BUTTONS

## 2 SET THE CONSOLE'S STATION NUMBER

1. PRESS A NUMBER BUTTON TO SET THE CONSOLE'S STATION NUMBER (SELECT A DIFFERENT STATION NUMBER FOR EACH CONSOLE)
2. THE SELECTED STATION NUMBER INDICATOR WILL FLASH

SETTING THE CONSOLE'S STATION NUMBER

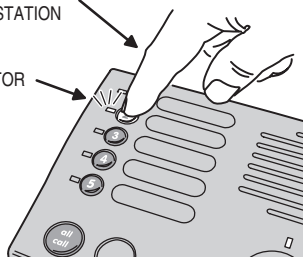

**NOTE: TO EXIT PROGRAMMING WITHOUT CHANGING THE HOUSE CODE NUMBER, PRESS THE TALK BUTTON TWICE**

## 3 SET THE CONSOLE'S NEW HOUSE CODE NUMBER

**NOTE: ALL UNITS MUST BE SET TO THE SAME HOUSE CODE NUMBER**

TALK BUTTON MAKES THE CONSOLE SOUND THE EXISTING HOUSE CODE NUMBER

BEEP!!  
BEEP!!

ALL CALL BUTTON ENTERS THE NEW HOUSE CODE NUMBER

FACTORY SETTING:  
HOUSE CODE = 10

BEEP!!  
BEEP!!  
BEEP!!  
BEEP!!

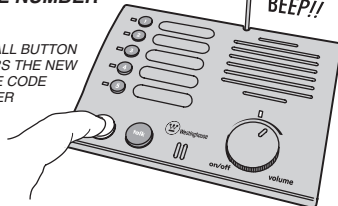
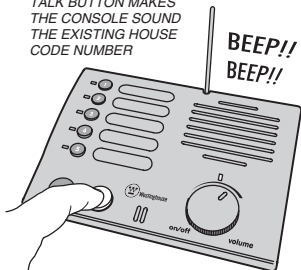

1. PRESS AND RELEASE THE TALK BUTTON
2. THE CONSOLE WILL BEEP, COUNTING THE EXISTING HOUSE CODE NUMBER

1. PRESS THE ALL CALL BUTTON 1 TO 15 TIMES TO SET THE NEW HOUSE CODE NUMBER
2. THE CONSOLE WILL BEEP, COUNTING THE NEW HOUSE CODE NUMBER
3. PRESS THE TALK BUTTON TO EXIT PROGRAM MODE

# CHANGING A DOORBELL'S SETTINGS

## 1 TO CHANGE A DOORBELL OR ADD A NEW DOORBELL

THE FACTORY SETTING FOR THE FREQUENCY SWITCH IS "A", SET THE FREQUENCY SWITCH TO MATCH THE CONSOLE (EITHER "A" OR "B")

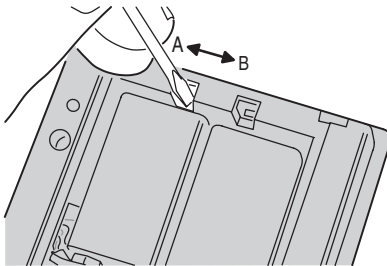

**NOTE: UNITS ARE PRE-SET AT THE FACTORY WITH THE SAME HOUSE CODE, CHANGING THE HOUSE CODE IS ONLY NECESSARY WHEN ADDING ADDITIONAL UNITS OR TO AVOID OVERLAP WITH OTHER SYSTEMS**

THE FACTORY SETTING FOR THE STATION SWITCH IS "5", SET THE STATION SWITCH TO EITHER "4" OR "5"

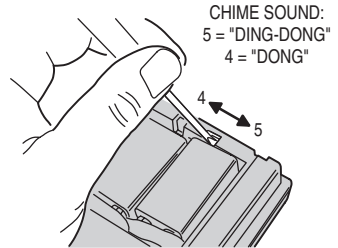

## 2 PLACE THE DOORBELL INTO PROGRAM MODE AND COUNT THE EXISTING HOUSE CODE BEEPS

1. BE SURE THE GREEN POWER LIGHT IS OFF (IF THE LIGHT IS ON, WAIT ABOUT 2 MINUTES)
2. USE AN OBJECT TO PRESS AND HOLD THE PROGRAM BUTTON UNTIL A BEEP SOUNDS
3. RELEASE THE PROGRAM BUTTON (BE READY TO COUNT BEEPS)
4. THE DOORBELL WILL BEEP, COUNTING THE EXISTING HOUSE CODE NUMBER

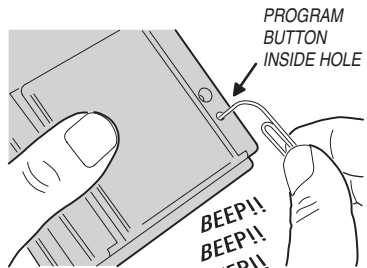

DOORBELL BEEPS THE EXISTING HOUSE CODE NUMBER

FACTORY SETTING:  
HOUSE CODE = 10

## 3 SET THE DOORBELL'S NEW HOUSE CODE NUMBER

1. PRESS THE TALK BUTTON 1 TO 15 TIMES TO SET THE NEW HOUSE CODE NUMBER
2. THE DOORBELL WILL BEEP, COUNTING THE NEW HOUSE CODE NUMBER

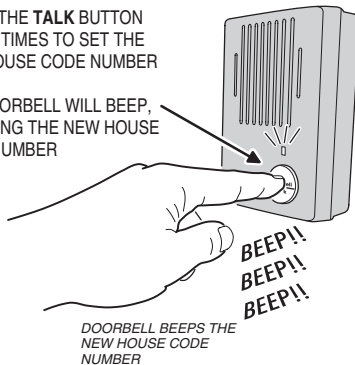

**NOTE: ALL UNITS MUST BE SET TO THE SAME HOUSE CODE NUMBER**

3. PRESS THE PROGRAM BUTTON TO EXIT PROGRAM MODE

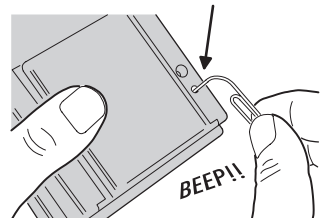

## ***TROUBLESHOOTING***

<b>SYMPTOM</b>	<b>REMEDY</b>
POWER INDICATOR WILL NOT LIGHT	BE SURE THE CONSOLE TRANSFORMER IS PLUGGED INTO AN UN-SWITCHED OUTLET  BE SURE THE DOORBELL UNIT HAS FRESH 9-VOLT ALKALINE BATTERIES
EXCESSIVE HUM FROM THE SPEAKER	KEEP CONSOLE AWAY FROM FLUORESCENT LIGHTS  MOVE DOORBELL UNIT IF IT IS NEAR AN AC LINE
SYSTEM FAILS TO WORK AT DISTANCE	BE SURE THE CONSOLE ANTENNA IS POINTED UP  MOVE UNITS AROUND TO DETERMINE BETTER RECEPTION LOCATIONS
SYSTEM RECEIVES VOICE SIGNALS FROM NON-RELATED EQUIPMENT	CHANGE THE FREQUENCY SWITCHES ON EACH UNIT (ALL UNITS MUST BE ON THE SAME FREQUENCY)  CHANGE THE HOUSE CODE
SYSTEM RECEIVES ELECTRICAL NOISE	MOVE UNITS AWAY FROM COMPUTERS, ELECTRIC MOTORS, LIGHT DIMMER SWITCHES, ETC.
SYSTEM FAILS TO FUNCTION	PERFORM THE SYSTEM PROGRAMMING AGAIN  MOVE UNITS AWAY FROM METAL OBJECTS
SYSTEM FUNCTIONS ERRATICALLY	BE SURE THAT THERE IS AT LEAST 6 FEET SPACING BETWEEN UNITS

## ***IMPORTANT FCC NOTICE***

---

Radio controls provide a reliable communications link and fill an important need in portable wireless signaling. However, there are some limitations which must be observed.

- For U.S. installations only: The radios are required to comply with FCC Rules and Regulations as Part 15 and FRS Part 95 devices. As such, they have limited transmitter power and therefore limited range.
- A receiver cannot respond to more than one transmitted signal at a time and may be blocked by radio signals that occur on or near their operating frequencies, regardless of code settings.
- Changes or modifications to the device may void FCC compliance.
- Infrequently used radio links should be tested regularly to protect against undetected interference or fault.
- A general knowledge of radio and its vagaries should be gained prior to acting as a wholesale distributor or dealer, and these facts should be communicated to the ultimate users.
- This device complies with FCC Part 15 and FRS Part 95 Rules and Regulations. Operation is subject to the following two conditions: (1) This device may not cause harmful interference, and (2) this device must accept any interference received, including interference that may cause undesired operation.
- This device and its antenna must not be co-located or operating in conjunction with any other antenna or transmitter





## Free Manuals Download Website

<http://myh66.com>

<http://usermanuals.us>

<http://www.somanuals.com>

<http://www.4manuals.cc>

<http://www.manual-lib.com>

<http://www.404manual.com>

<http://www.luxmanual.com>

<http://aubethermostatmanual.com>

Golf course search by state

<http://golfingnear.com>

Email search by domain

<http://emailbydomain.com>

Auto manuals search

<http://auto.somanuals.com>

TV manuals search

<http://tv.somanuals.com>