



Westinghouse

Stand Mixer



INSTRUCTIONAL
DVD
INCLUDED

CHEF ✓
TESTED

Model: SA 61950
Operation Instruction Manual



Westinghouse

Congratulations on your purchase of the Westinghouse Stand Mixer! This product was proudly manufactured with quality by SAI Home Products.

Hello, I'm Chef Rick Tarantino, Executive Chef for Westinghouse Kitchen Products and SAI Home Products. On behalf of our worldwide team we want to thank you for your purchase.

Each product is tested in our kitchens for design, functionality, durability, and performance. As a professional chef, I use the Westinghouse products every day. If it says "Chef Tested" you can be sure it will work as well for you as it does for me.

If you have any questions we invite you to contact our customer service center at 1-866-365-5339. Also visit our website at www.saihomeproducts.com for great ideas, recipes and more.

I know you will enjoy your Westinghouse product. We are glad you have us in your kitchen.

Simplify your life and make your house a home, a Westinghouse home. You can be sure if it's Westinghouse.

Chef Rick Tarantino

Table of Contents

Thank You Letter.....	2
Knowing Your Stand Mixer.....	4
Unpack and Before to Use.....	5
Assembling Your Stand Mixer.....	5
Operating Your Stand Mixer.....	9
Speed Control.....	11
Speed Control Guide.....	11
Useful Tips.....	12
Special Note.....	12
Care and Cleaning	12
Troubleshooting	13
Important Safeguards.....	14
Warranty and Service Center Information.....	16
Recipes	17

Knowing Your Stand Mixer

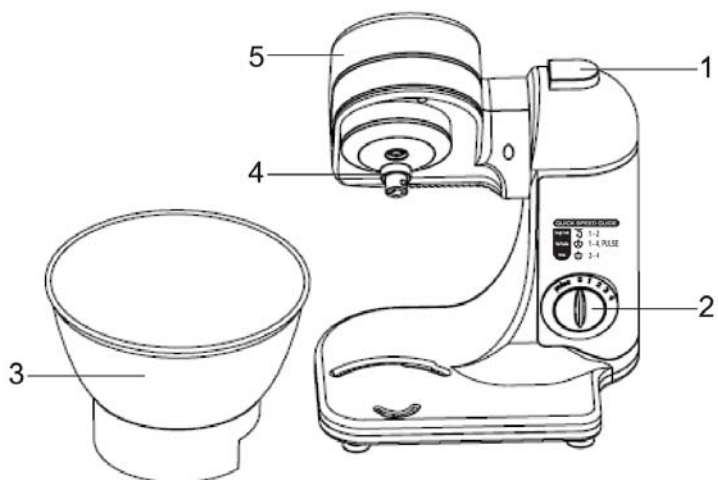

Fig.A

Description:

- | | |
|------------------------------|--------------------|
| 1. Mixer Head Release Button | 4. Attachment Post |
| 2. Rotary Speed Control | 5. Mixer Head |
| 3. Stainless Steel Bowl | |

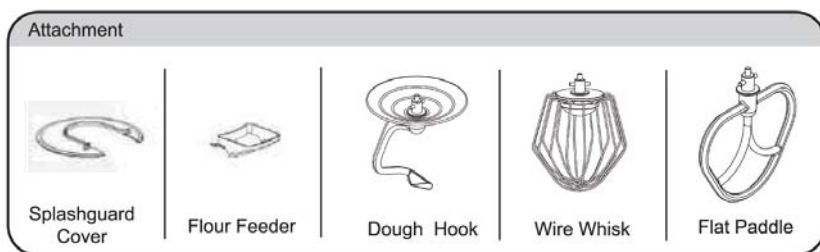

Fig.B

Unpack and Before to Use

1. Carefully remove the power unit from its packaging and place it on a firm flat surface away from faucets, sinks and heat sources. As you remove the accessories from the carton, check them against Fig. A and B to ensure that all the standard parts are present.
2. Before using your stand mixer, wash bowl and attachments in hot, soapy water, rinse well and dry. The bowl and attachments are also dishwasher safe.
3. Assembling your stand mixer.

Note: Always set the rotary speed control to "O" and unplug the power cord before attaching or removing the attachments, accessories and parts.

Assembling Your Stand Mixer

Attach the Bowl

1. Make sure the power cord is unplugged and the "Rotary Speed Control" (2) is set to "O". (Fig.1.1)
2. Press the "Mixer Head Release" Button (1) (Fig1.2) and lift the "Mixer Head" (5) up (Fig1.3) until it locks into place.

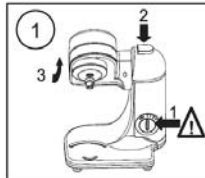

3. Place "Bowl" (3) on the bowl locking plate (Fig.2) and turn clockwise (Fig.3) until it locks into place.

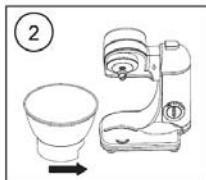

Attach the Dough Hook, Wire Whisk or Flat Paddle

1. Make sure the power cord is unplugged and the "Rotary Speed Control" (2) is set to "0".
2. Press the "Mixer Head Release" Button (1) (Fig4.1) and lift the "Mixer Head" (5) up (Fig4.2) until it locks into place.



3. Insert desired attachment onto "Attachment Post" (4) and press upward as far as possible. (Fig.5)



4. Turn the attachment clockwise (Fig.6,6a), hooking the attachment to the post.

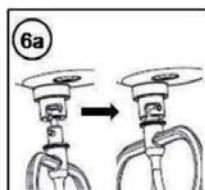
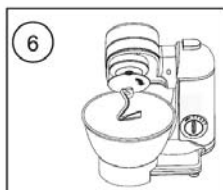

5. Be sure the "Bowl" (3) is attached to the mixer before operating.
6. Lower the "Mixer Head" (5) by pressing the "Mixer Head Release Button" (1) (Fig.7.1) and guiding the mixer head down carefully (Fig.7.2) with your hands.

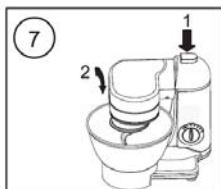

Fit and Use your Splashguard Cover and Flour Feeder

1. Raise the "Mixer Head"(5) until it locks.
2. Fit the "Bowl"(3) onto the base.
3. Attach desired attachment.
4. Lower the "Mixer Head".
5. Place the "Splashguard Cover" on to the "Bowl". The cut-out section should be positioned as shown. (Fig.8)

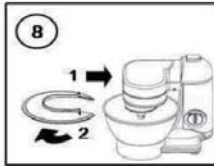

6. Attach the detachable flour feeder to the "Splashguard Cover" as shown. (Fig.9)

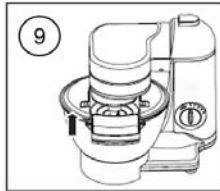

NOTE: During mixing, ingredients can be added directly to the bowl

Remove the Bowl

1. Make sure that the "Rotary Speed Control "(2) is set to "O" and the power cord is unplugged.
2. Press the "Mixer Head Release Button"(1) (Fig.10.1) and lift the "Mixer Head"(5) up (Fig.10.2) until it locks into place.

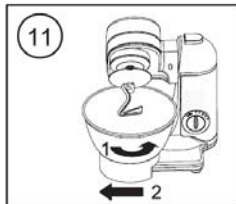

3. Turn the "Bowl"(3) counter-clockwise (Fig.11.1) to unlock and remove. (Fig.11.2)

Remove the Dough Hook, Wire Whisk or Flat Paddle

1. Make sure that the "Rotary Speed Control" (2) is set to "0" and the power cord is unplugged.
2. Unhook the attachment from the post by pressing the attachment upward and then turns it counter-clockwise. (Fig.12)

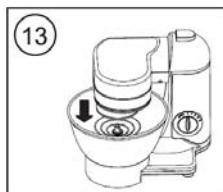
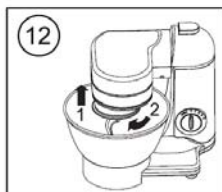

3. Remove the attachment from "Attachment Post" (4). (Fig.13)
4. Press the "Mixer Head Release Button" (1) (Fig.14.1) and lift the "Mixer Head" (5) up by hands until it locks into place. (Fig.14.2)



5. Remove the attachment and the "Bowl" (3) from the mixer. (Fig.15)

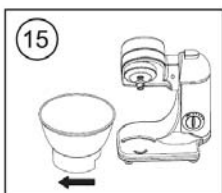

Operating Your Stand Mixer

General Operations

1. Place the stand mixer on suitable work surface. The surface should be sturdy, flat, smooth and clean; make sure that there is no flour or oil on the surface and away from faucets, sinks and heat sources. A clean smooth surface will provide the best footing and will limit slipping and/or "walking". The mixer is also designed with suction cups on the base for extra hold on the work surface to prevent slippage and provide added security.
2. Make sure the "Rotary Speed Control"(2) is set to "O" and unplugged from electrical outlet.
3. Press the "Mixer Head Release Button"(1) and lift "Mixer Head"(5) up by hand until it locks into place.
4. Select attachment you wish to use and attach to the Attachment Post. (see *Assembling Your Mixer, section: To attach the dough hook, wire whisk or flat beater*)
5. Lock "Bowl"(3) onto the bowl locking plate. (see *Assembling Your Mixer, section: To attach the bowl*)
6. Lower the "Mixer Head" by pressing the "Mixer Head Release Button" and guiding the "Mixer Head" down carefully with your hands. If the "Mixer Head" fails to lock into place, check the "Bowl" to make sure that it is properly in place.
7. Place the "Splashguard Cover" on the "Bowl". (see *Assembling Your Mixer, section: To fit and use your anti-splash cover*) The cover has an integral feeding funnel. The cover may be removed to add ingredients, but the cover should be in place whenever the mixer is in operation. It is highly recommended to add ingredients through the funnel. The "Splashguard Cover" serves to prevent the escape of flour dust at the beginning of the stirring and kneading process, and also serves to prevent accidental contact with the moving "Dough Hook".
8. Plug the mixer into an electrical outlet nearby.
9. Turn the "Rotary Speed Control" to desired speed setting. The mixer will start gradually, to avoid spattering, and build up to the selected speed.
10. To change the speed during operation, simply turn the "Speed Control" to the desired setting.
11. To turn mixer off, turn the "Rotary Speed Control" to "O". The unit will keep turning for approximate 3 cycles to its park position before the mixer head completely stops. This is the normal operation and allows you to slowly lift the beater from the mixer. This special operational design provides for a smooth stop to the rotary action and extends the life of the appliance. Unplug the appliance from the electrical outlet.
12. To remove attachment (*Dough Hook, Wire Whip or Flat Paddle*), press them up as far as possible, then turn clockwise to release. Pull from the attachment post.

Warning:

To avoid risk of injury, be sure to switch off the stand mixer before scraping the sides of the Bowl. The Bowl is designed to mix effectively and require minimal scraping. Never attempt to scrape the sides of the Bowl while the mixer is operating.

Use Dough Hook

The dough hook is used for mixing bread dough of all kinds. The design of the hook is excellent for pulling sticky dough away from the side of the mixing bowl, and the cap on the hook prevents the dough from crawling up the hook and keeps it in the right mixing position. The dough hook and mixing bowl are intended to be used to knead yeast doughs and to mix heavy cookie and pastry doughs, and also when adding nuts, chocolate chips, dried fruit, hard butter or shortening, hardened brown sugar, etc. to batters.

Use Wire Whisk

The whisk incorporates air into liquid mixtures. The beating whisk is intended to be used for very light substances, such as cream, egg whites, sauces, batters and light pastry doughs that are thin enough to pour. As the whisk rotates faster the mixture becomes thicker and creamier. Meringues, frostings, and thick sauces are all made using this attachment.

Use Flat Paddle

The paddle is used for mixing thicker and heavier cookie and cake batters where the incorporation of air is not critical to the recipe. The flat paddle is also intended to be used for stirring items at low speed, such as cake mixes and light cookie doughs.

Always be sure to use the dough hook for heavy cookie doughs.

Removing Contents

1. Before beginning to remove the contents from the "*Bowl*"(3), make sure that the "*Rotary Speed Control*"(2) is set to "O" and the power cord is unplugged. Remove the "*Splashguard Cover*". Press the "*Mixer Head Release Button*"(1) and lift the "*Mixer Head*"(5) upward until it locks into place. Remove the attachment from the attachment post.
2. The Bowl can be removed from the main unit by twist counter-clockwise.
3. The contents may now be used as desired.

Speed Control

Operate Unit with Rotary Speed Control



The speed of its moving components can be controlled through the use of the “Rotary speed Control”(2) at the front of the ergonomic stand. The “Rotary speed Control” has six positions:

- “Pulse”: turbo speed and only use for “Flat Paddle” attachment
- “O”: the off position
- 4 speeds labeled - “1”, “2”, “3” and “4”: (Speed 1 is the lowest speed. The speed increases with each succeeding step up to the highest speed, speed 4.)

Speed Control Guide

The following speed control guide provides suggested settings for your mixer. If in doubt, always start on a lower setting and work your way up.

NOTE: *When working with ingredients that spatter easily, start on a lower speed and then proceed to the recommended setting.*

ATTACHMENT	FUNCTION	SETTING GUIDE
Dough Hook 	Folding	1
	Yeast Dough (bread dough, pizza dough)	1 ~ 2
	Heavy Pastry Dough	1 ~ 2
	Heavy Mixes	1 ~ 2
Flat Paddle 	Mix	2 ~ 4
	Cookie Dough	2 ~ 4
	Blend	1 ~ 3
	Combine	1 ~ 3
	Cream	1 ~ 3
	Meatloaf	1 ~ 3
	Stir	1 ~ 3
	Mash potato	1 ~ 3
Wire Whisk 	Whip Cream	1 ~ 4
	Egg Whites	1 ~ 4
	Desserts	1 ~ 4
	Frosting	1 ~ 4

Useful Tips

- Before adding ingredients to the “*Bowl*” during operation, turn the “*Rotary Speed Control*” to a lower speed. Always add the ingredients through the “*Flour Feeder*”.
- When adding flour to recipes, mix at a low speed until incorporated.
- Mixtures with large quantities of liquid should be mixed at lower speeds to avoid splattering.
- Be sure to watch liquids closely while whipping, since the powerful 450-watt motor beats quickly.
- When using the mixing bowl to knead or mix a recipe designed to be prepared by hand, you will find that with the Westinghouse stand mixer you can usually place all the ingredients in the mixing bowl at once. When doing this, always place the liquids in first. This will assure more thorough mixing.

Special Note

When your work with the attachment is completed, turn the “*Rotary Speed Control*” (3) to off position “O”. The mixer will keep turning for approximate 3 cycles to its park position before the mixer head completely stop. This is the normal operation and allows you to slowly lift the beater from the mixer. This special operational design provides for a smooth stop to the rotary action and extends the life of the appliance. Then unplug the unit from an electrical outlet.

Care and Cleaning

Always unplug the appliance after each use and before attempting to clean. Failure to do so can result in broken bones , cuts or electrical shock.

1. Make sure the “*Rotary Speed Control*” is set to ‘O’ and the appliance is unplugged before cleaning.
2. Wait until the motor head has come to a complete stop; when switched off, the motor head will continue to turn for a brief period.
3. Please do not place hands into mixing bowl until the appliance comes to a complete stop in order to prevent possible injury.
4. Press the “*Mixer Head Release Button*”(1) and lift the “*Mixer Head*”(5) up.
5. Remove attachments by pressing them up as far as possible, then turn counterclockwise to release. Pull from the attachment post.
6. The “*Bowl*” and attachments can be washed in warm, soapy water or in a dishwasher. Attachments are top rack dishwasher safe.
7. Wipe down the “*Mixer Head*” and main unit with a damp cloth. DO NOT immerse the unit, power cord and plug in water or liquid. Do not use an abrasive or cleaning pad on the mixer base.
8. DO NOT use household cleaners that contain bleach or pine cleaners. Do not use any type of solvent-based cleaner or metal polish on the mixer base. Do not spray cleaners directly on the mixer. Cleaners should be applied to a clean cloth before using on the mixer. If these cleaning products DO come in contact with the mixer, immediately clean with a water-dampened cloth and wipe dry.

Stainless Steel Bowl

- The stainless steel mixing bowls are designed for use in the oven.
- The stainless steel mixing bowls are not suitable for use in microwave ovens.
- The stainless steel bowls may be used in the refrigerator or freezer.
- For best results, hand wash the mixing bowl. Stainless steel bowls may be cleaned in the dishwasher.

Splashguard Cover & Flour Feeder

Clean thoroughly in warm mild soapy water, rinse and then dry thoroughly.

Troubleshooting

Problem	Solution
The unit does not turn on	<ul style="list-style-type: none">• Plug in the appliance.• Contact an authorized service center.
The mixer does not start	<ul style="list-style-type: none">• Check the power cord to make sure it is securely fastened into the mixer and into the electrical outlet.• Make sure the mixer head has been lowered and locked into place.• Be sure you've turned the rotary speed control to one of the 5 power settings.
The mixer bowl wobbles back and forth when mixing	<ul style="list-style-type: none">• Make sure the bowl is securely locked into place on the bowl locking plate before operating the mixer. The bowl should be level and will lock into place with a slight turn.• Make sure that the beater attachment is not contacting the bowl.
The mixer is splattering ingredients outside the mixer bowl	<ul style="list-style-type: none">• The bowl may be overloaded.• The speed may be turned up too high. The 450-watt motor on your mixer is powerful. Try a lower speed.
The mixer motor seems to be bogging down	<ul style="list-style-type: none">• The mixing bowl may be overloaded with a heavy mixture. If so, divide into smaller portions and resume mixing.
The mixer shuts down while mixing	<ul style="list-style-type: none">• The mixer has been designed to protect itself from damage while mixing heavy loads. Divide the load into smaller portions. Restart the mixer.

IMPORTANT SAFEGUARDS

When using electrical appliances, basic safety precautions should always be observed, including the following:

1. Read all of the instructions contained in this manual before using the appliance.
2. This product is not intended for commercial or outdoor use; it is only for household and indoor use. Use for anything other than intended use will void the warranty.
3. To protect against risk of electrical shock, do not put the cord, plug or appliance into water or other liquid, or use it near a sink or wash basin.
4. Do not use the appliance with wet hands.
5. Do not use an extension cord with this appliance, have a qualified electrician or serviceman install an electrical outlet near the appliance.
6. Do not let the cord hang over the edge of a table or counter. Do not let cord contact hot surfaces, including stove.
7. Do not place the appliance, parts and accessories on or near a hot gas or electric burner, or in a heated oven.
8. Avoid contacting moving parts and fitted attachments. Keep hands, hair, clothing, as well as spatulas and other utensils away from beater during operation to reduce the risk of injury to persons and/or damage to the appliance.
9. Do not operate the appliance with a damaged cord or plug, or after the mixer malfunctions, or is dropped or damaged in any manner. Return the appliance to the nearest authorized service facility for examination, or repair.
10. Always work with the splashguard cover fitted in place.
11. Never exceed the maximum capacities.
12. When used for heavy loads or at high speeds, the mixer may move on a work surface.
13. Do not change tools until the motor head has come to a complete stop; when switched off, the motor head will continue to turn for a brief period.
14. Take care when lifting this appliance as it is heavy. Ensure the head is locked and that the bowl, tools, outlet covers and cord are secure before lifting.
15. Using attachments not recommended or sold by the appliance manufacturer for use with this model is not recommended and may cause fire, electric shock or injury.
16. This appliance is not intended for use by persons (including children) with reduced physical, sensory or mental capabilities, or lack of experience and knowledge, unless they have been given supervision or instruction concerning use of the appliance by a person responsible for their safety.
17. Close supervision is necessary when any appliance is used near children.
18. Do not operate the appliance unattended or near the edge of a work surface.
19. Remove flat paddle, wire whip, dough hook and other attachments from stand mixer before washing.
20. This appliance should always be turned off before plugging into or unplugging from an electrical outlet when not in use, before putting on or taking off parts and before cleaning.
21. Do not disassemble the appliance. Return to the nearest authorized service facility for examination, or repair. Never attempt to open and make any modifications to or repair the appliance yourself. Incorrect reassembly can cause a risk of electric shock when it is being used.

Polarized Plug

Warning: This appliance has a polarized plug (one blade is wider than the other). To reduce the risk of electric shock, this plug is intended to fit into a polarized outlet only one way. If the plug does not fit fully into the outlet, reverse the plug. If it still does not fit, contact a qualified electrician. Do not attempt to modify the plug in any way.

DO NOT DEFEAT THE SAFETY PURPOSE OF THE POLARIZED PLUG.

**HOUSEHOLD USE ONLY
SAVE THESE INSTRUCTIONS**

In the interest of improving products, SAI Home Products, Inc. reserves the right to change specifications without prior notice.

LIMITED WARRANTY

This Westinghouse product is warranted to be free from defects in material and craftsmanship for a period of 1 year from the date of purchase.

If service should be necessary, please contact our Consumer Care Department listed below for instructions and a return authorization number. You may then return the product properly packaged and postage prepaid along with your proof of purchase, name, address, telephone number, and a description of the claimed defect. Any part or parts, which upon examination by the manufacturer, are found to be defective, will be repaired or replaced with a similar product without charge during the warranty period. If a replacement product is sent, it will carry the remaining warranty of the original product.

The warranty does not apply to costs incurred in removal, shipment, or reinstallation of the product, nor does it cover any incidental or consequential damages. It is the responsibility of the consumer to ensure that this product is installed in a location and in a manner that is appropriate for its intended use. Product that has been damaged by shipping, water conditions, service by unauthorized personnel, or maintenance or usage other than that recommended by the manufacturer are specifically excluded from the warranty.

The warranty is limited to the original consumer with proof of purchase and is not transferable. If the product was not purchased new from an authorized dealer, distributor, or representative of the manufacturer, this warranty is null and void.

THE MANUFACTURER'S LIABILITY UNDER THIS WARRANTY IS LIMITED TO THE REPAIR OR REPLACEMENT OF THE DEFECTIVE PRODUCT AT THE MANUFACTURER'S SOLE OPTION. THE MANUFACTURER SHALL NOT BE LIABLE FOR ANY INCIDENTAL OR CONSEQUENTIAL DAMAGES, WHETHER DIRECT OR INDIRECT. THIS WARRANTY IS EXPRESSLY GRANTED IN LIEU OF ALL OTHER WARRANTIES INCLUDING THE IMPLIED WARRANTIES OF MERCHANTABILITY AND FITNESS FOR A PARTICULAR PURPOSE.

What Is Not Covered by This Warranty

1. Conditions and damages resulting from any of the following:
 - a. Any repair, disassembly, modification, alteration or adjustment not authorized by SAI Home Products, Inc.
 - b. Misuse, abuse, accidents, unreasonable use, negligence or failure to follow the SAI Home Products, Inc. instructions.
 - c. Incorrect electric current, voltage or supply other than listed on the product.
 - d. Improper setting of any control.
2. Products purchased for commercial or industrial use.
3. Consequential or incidental damages sustained by any person as a result of any breach of these warranties. Some states do not allow the exclusion or limitation of consequential or incidental damages, so the above exclusion may not apply.

If service should become necessary, please contact us at: 1-866-365-5339

To return a product for warranty service:

1. Repackage your product in its original packaging, or proper packaging to protect the product.
2. Include proof of purchase with product (copy of order, packing slip, etc.) along with name, address, and reason for return.
3. Attach correct postage and mail unit to:
SAI Home Products, Inc.,
Westinghouse Consumer Care, Department 4000,
7850 Ruffner Avenue, Van Nuys, CA91406

SERVICE CENTER INFORMATION IS SUBJECT TO CHANGE.

Please visit our website at www.saihomeproducts.com or call 1-866-365-5339 for automated service center information.

Copyright © 2010 SAI Home Products, Inc.
SAI Home Products Inc.

Westinghouse Consumer Care, Department 4000, 7850 Ruffner Avenue, Van Nuys, CA91406



, Westinghouse, and You can be sure ... if it's Westinghouse are trademarks of Westinghouse Electric Corporation.

Manufactured and Marketed by SAI Home Products, Inc. under license.
All Rights Reserved.

Recipes

Gluten Free Focaccia Dough Pizza with Spinach and Feta Cheese

Makes 2 small pizzas or one large

Ingredients

- 1 cup warm water (105 – 115°F)
- 1 tablespoon sugar
- 2 tablespoons active dry yeast
- 2 cups white rice flour
- 1/2 cup soy flour
- 2 cups tapioca flour
- 2/3 cup instant non-fat dry milk powder
- 3 teaspoons xanthium gum
- 2 teaspoons Italian Seasonings
- 1 teaspoon salt
- 3 tablespoons olive oil
- 4 egg whites at room temperature
- Vegetable oil spray
- 1 lb of fresh spinach leaves washed and chopped
- 8oz of feta cheese

Directions

- Preheat the oven to 400°F. Combine ½ cup of warm water, 2 tablespoons active dry yeast and 1 tablespoon of sugar and set this yeast mixture aside. Spray two large baking pans with vegetable oil and set aside.
- Combine the white rice flour, soy flour, milk powder, tapioca flour, xanthium gum, Italian seasonings and salt in the bowl of the Westinghouse Stand mixer with the Flat Paddle and set on low. Mix the dry ingredients well and then add the 3 tablespoons of olive oil with the remaining 1/2 cup of water, slowly pouring into the bowl.

- Add the egg whites slowly until the mixture is well incorporated. Add the yeast mixture and increase the speed to high and continue to mix for 4 minutes until dough starts to form a ball.
- Remove the dough from the mixing bowl and evenly divide into two balls. Place one of the dough balls onto each pan, coat with vegetable or olive oil and place in bowls or sheet pan, cover with plastic wrap or damp towel. Set aside for 30-45 minutes to rise.
- Place dough on a counter top sprinkled with rice flour. Flatten and stretch out dough using your hands and finger tips, working slowly outward transfer to your pizza stone or pan, spread until it fits your stone or pan. Using your knife prick holes all around the dough to allow air to escape when cooking.
- Place the dough into the oven and let cook for 5-7 minutes. Remove from the oven and top with fresh chopped spinach and feta cheese. Place back into the oven and continue to cook until the crust is golden brown and crispy, 10 to 12 minutes longer. You can also use your Westinghouse TriTec CSV oven quick menu, set it to pizza and follow the instructions.

Meringue Cookies

Makes 5 dozen

Ingredients

- 1/2 cup butter
- 1/3 cup sugar
- 2 egg yolks
- 1/2 tsp. vanilla
- 1/4 tsp. grated lemon rind
- 1 cup sifted flour
- 1/3 tsp. salt
- Jam or Jelly, for spreading

Directions

- Using your Westinghouse Stand Mixer blend 1/2 cup butter and 1/3 cup sugar on #2 setting with your paddle attachment.
- Then add and beat in 2 egg yolks, 1/2 tsp. vanilla or almond extract, 1/4 tsp. grated lemon rind, 1 cup sifted flour and 1/3 tsp. salt.
- Place dough into wax paper and roll into a log about 3 inches in diameter.
- Place in refrigerator and Chill dough for several hours.
- When ready to cook roll very thin and cut into thin cookies 1/2 inch thick.
- Place on a nonstick cookie sheet and spread about 1/2 teaspoon of jam or jelly in center of each cookie.
- Then place your meringue into a pastry bag with a star tip, and pipe out meringue in a spiral fashion to cover jam and cookie.
- Place in 350°F preheated oven and cook for 12 minutes or until the meringue is brown. You can also use your Westinghouse Tritec CSV oven auto menu and select cookies.

Meringue

Ingredients

- 1 egg white
- 5 tbsp. sugar

Directions

Whip 1 egg white until stiff, then adding 5 tbsp. sugar very slowly, beating constantly.

Free Manuals Download Website

<http://myh66.com>

<http://usermanuals.us>

<http://www.somanuals.com>

<http://www.4manuals.cc>

<http://www.manual-lib.com>

<http://www.404manual.com>

<http://www.luxmanual.com>

<http://aubethermostatmanual.com>

Golf course search by state

<http://golfingnear.com>

Email search by domain

<http://emailbydomain.com>

Auto manuals search

<http://auto.somanuals.com>

TV manuals search

<http://tv.somanuals.com>