

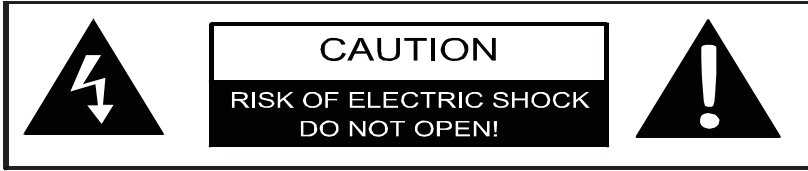

USER'S MANUAL
MANUEL DE L'UTILISATEUR
MANUAL DEL USUARIO

EW40T4FW

1	IMPORTANT INFORMATION		2
2	HOW TO INSTALL THE STAND		4
3	PREFACE		5
4	SAFETY PRECAUTIONS		5
5	CARTON CONTENTS		7
6	OVERVIEW		8
7	INSTALLATION	Power Cord Connection	9
		Antenna Connection	9
		AV Connection	10
		YPbPr(component) Connection	10
		VGA(PC) Connection	11
		COAX Connection	11
		HDMI Connection	12
		Service Port Function	12
8	REMOTE CONTROL	Remote control instructions in TV mode	13
		Remote control setup	14
9	MENU OPERATION	Setup Wizard	15
		Select Input Source	17
		Basic Operation	17
		Picture Menu	18
		Sound Menu	21
		Time Menu	22
		Setup Menu	23
		Lock Menu	25
		Channel Menu	27
Picture Menu	29		
10	TROUBLESHOOTING		30
11	SPECIFICATIONS		31



The lightning flash with arrowhead symbol, within an equilateral triangle, is intended to alert the user to the presence of un-insulated dangerous voltage within the products enclosure that may be of sufficient magnitude to constitute a risk of electric to persons.



The exclamation point within an equilateral triangle is intended to alert the user to the presence of important operating and maintenance (servicing) instruction the literature accompanying the appliance.

CAUTION: USE OF ANY CONTROLS, ADJUSTMENTS, OR PROCEDURES OTHER THAN THOSE SPECIFIED HEREIN MAY RESULT IN HAZARDOUS RADIATION EXPOSURE.

CAUTION: These servicing instructions are for use by qualified service personnel only. To reduce the risk of electric shock, do not perform any servicing other than that contained in the operating instructions unless you are qualified to do so.

Refer to service manual for servicing instructions.

ENERGY STAR® :

This Westinghouse product has earned the Energy Star® for meeting U.S. Federal energy efficiency guidelines asset by the Department of Energy and Environmental Protection agency. The Energy Star® program exists to provide energy saving guidelines and help promote energy efficient products and practices. Changes to certain features, settings and functions of this TV can change and/or increase its power consumption. Depending on how settings are changed, power consumption may exceed the limits required for Energy Star® qualification. This Westinghouse TV will operate at optimal energy efficiency in “Home” mode.

Important Safety Instructions

Note:

1. Read these instructions.
2. Keep these instructions.
3. Heed all warnings.
4. Follow all instructions.
5. Do not use near water.
6. Clean only with dry cloth.
7. Do not block any ventilation openings. Install in accordance with the manufacturer's instructions.
8. Do not install near any heat sources such as radiators, heat registers, stoves, or other apparatus (including amplifiers) that produce heat.
9. Do not defeat the safety purpose of the polarized or grounding-type plug. A polarized plug has two blades with one wider than the other. A grounding type plug has two blades and a third grounding prong. The wide blade or the third prong are provided for your safety. If the provided plug does not fit into your outlet, consult an electrician for replacement of the obsolete outlet.

10. Protect the power cord from being walked on or pinched particularly at plugs, convenience receptacles, and the point where they exit from the apparatus.
11. Only use attachments / accessories specified by the manufacturer.
12. Use only with the cart, stand, tripod, bracket, or table specified by the manufacturer, or sold with the apparatus. When a cart is used, use caution when moving the cart / apparatus combination to avoid injury from tip-over.



13. Unplug this apparatus during lightning storms or when unused for long periods of time.
14. Refer all servicing to qualified service personnel. Servicing is required when the apparatus has been damaged in any way, such as power-supply cord or plug is damaged, liquid has been spilled or objects have fallen into the apparatus, the apparatus has been exposed to rain or moisture, does not operate normally, or has been dropped.
15. Apparatus shall not be exposed to dripping or splashing and that no objects filled with liquids, such as vases, shall be placed on the apparatus.
16. WARNING: To reduce the risk of fire or electric shock, do not expose this apparatus to rain or moisture.
17. Mains plug or appliance coupler is used as the disconnect device, shall be readily operable.
18. WARNING: The battery (battery or batteries or battery pack) shall not be exposed to excessive heat such as sunshine, fire or the like.
19.  This equipment is a Class II or double insulated electrical appliance. It has been designed in such a way that it does not require a safety connection to electrical earth.

20.  is trademark of SRS Labs, Inc. TruSurround HD technology is incorporated under license from SRS Labs, Inc.

Licensing and Patent Information

This WESTINGHOUSE product may be covered by one or more U.S. and foreign patents and patent applications. See <http://westinghousedigital.com/compliance/> for details.

Energy Star



To meet Energy Star requirements, keep TV settings at the factory default settings.

How to install the stand!

Follow instructions below to install the base of the TV, reverse the instructions to remove the base.

1. Fix the base cover to the fixed-ring base as image 1;

image 1

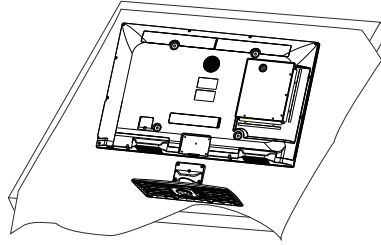

2. Fix the base cover to fixed-ring base with the screws.

image 2

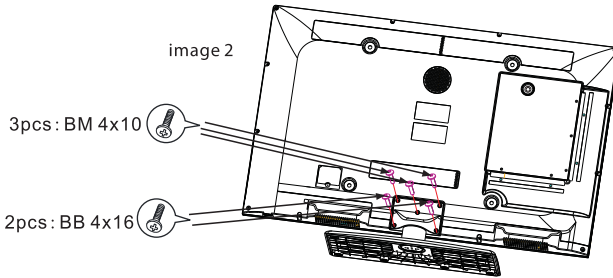
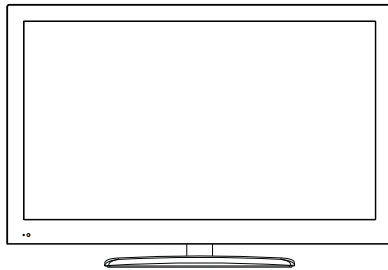

image 3



3. PREFACE

Thank you for buying this TV! Please read this manual thoroughly before operating the TV. Make sure the TV was not damaged in transit. If the TV is damaged, do not install it and contact the Westinghouse Customer Service.

4. SAFETY PRECAUTIONS



Put the TV on a stable surface.



Do not place any material on the TV.

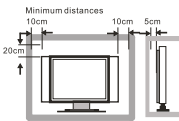

Do not use the TV with fixtures other than those provided or suggested by the manufacturer.



Do not block or cover the ventilation openings on the TV.



Power cord and cables must be properly routed and protected to prevent people from stepping on them and causing the TV to fall.

SAFETY PRECAUTIONS

English

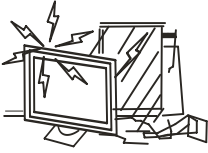

Keep the TV dry and away from humidity.

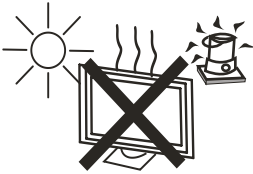

Keep the TV away from heat sources.



Unplug the TV before cleaning it. Do not use solvent or liquid to clean the TV.

Only clean the TV with a soft and dry cloth.

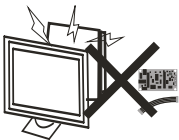

In case of troubleshooting, do not use spare parts other than those suggested by the manufacturer. Using inadequate spare parts can lead to electric shocks, short-circuits, fire or other incidents.



Unplug the TV during lightning storms or when unused for long periods of time.

5. CARTON CONTENTS

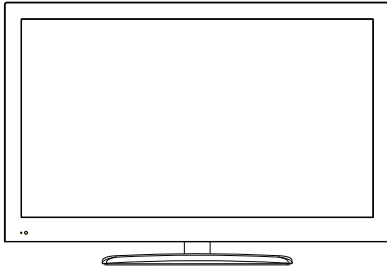

LED TV SET



Remote Control

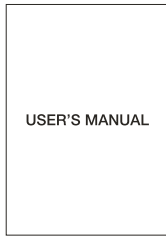

USER'S MANUAL

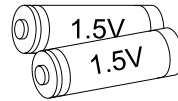

AAA Batteries

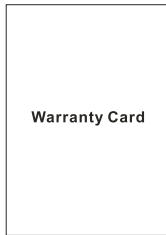

Warranty Card

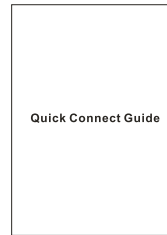

Quick Connect Guide

6. OVERVIEW

Front View

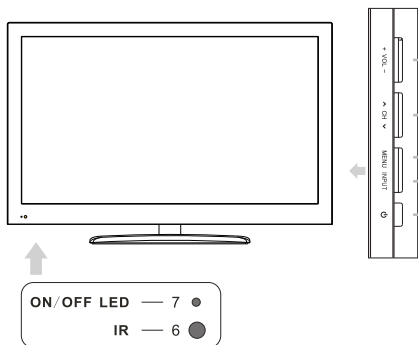

1. Press “POWER” button to turn the TV on or off.
2. Press “INPUT” to select the input source.
3. Press “MENU” to bring up the main menu on the screen.
4. Press “CH^” or “CHv” to scan through channels.
5. Press “VOL+” or “VOL-” to increase or decrease the volume.
6. REMOTE SENSOR: infrared sensor for the remote control.
7. POWER INDICATOR: Blue when TV is powered on. Red when TV is powered off.

English

Back View and Control Connections

Name	Function Description
① HEADPHONE	Connect to the audio equipment.
② USB (SERVICE)	USB port for factory use only.
③ HDMI	Connect to the HDMI output.
④ PC AUDIO	Connect the audio output jack of PC.
⑤ PC VGA	Connect to the PC-RGB output to jack of PC.
⑥ RF IN	Connect the antenna.
⑦ VIDEO	Connect the video output.
⑧ R/L	Connect to equipment with audio output.
⑨ COAX	Connect the COAX receiver.
⑩ YPbPr	Connect the YPbPr output.
⑪ AUDIO OUT	Connect to the audio equipment.

7. INSTALLATION

Power Cord Connection

- Connect the power cord into AC Power Source.

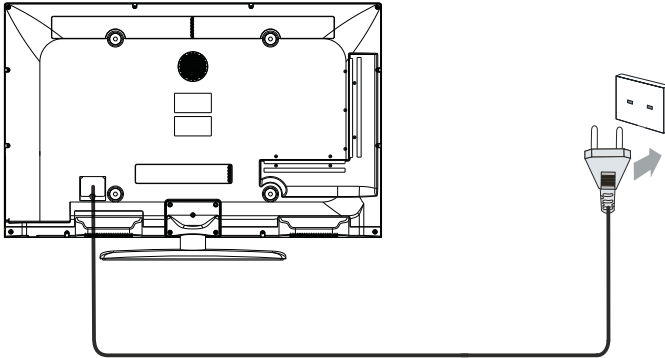

Antenna Connection

To ensure good picture and sound, TV antenna system needs to be installed. The antenna system as shown can be sourced from TV equipment shops, which will provide service for correct installation and connection. After installation, insert the 75-ohm antenna plug into the antenna jack as shown.

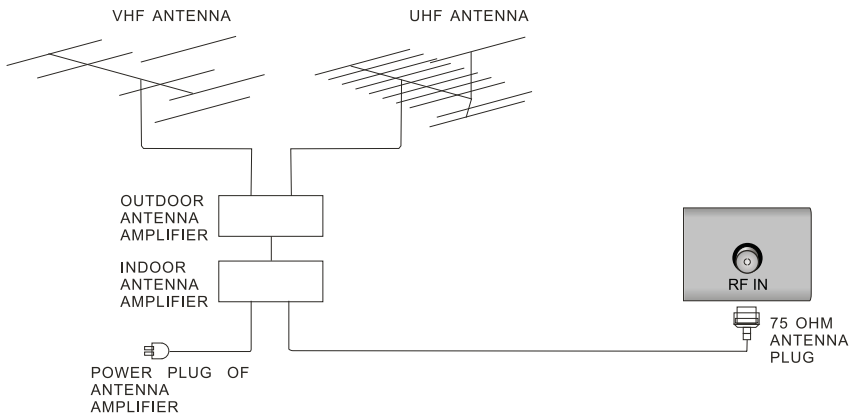

AV Connection

Connect the VIDEO and AUDIO output jack of a DVD or VCR to the AV jacks on the set using a RCA cable. Match the jack colors: Video is yellow, Audio left is white, and Audio right is red. Select the AV input source using the INPUT button on the remote control.

TV Back

English

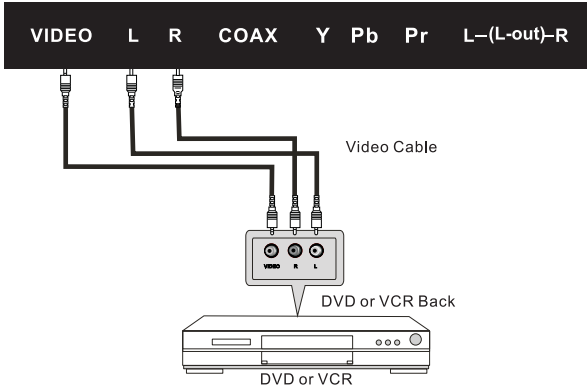

YPbPr(Component) Connection

Connect the YPbPr output of a DVD or VCR to the YPbPr input on the TV. The picture quality is improved compared to connecting a regular VCR to the video input. Connect the Audio output of a DVD or VCR to the Audio input jacks on the set using a RCA cable.

Match the jacks colors: Y is green, Pb is blue, Pr is red, Audio left is white and Audio right in red. Select component input source using the INPUT button on the remote control.

TV Back

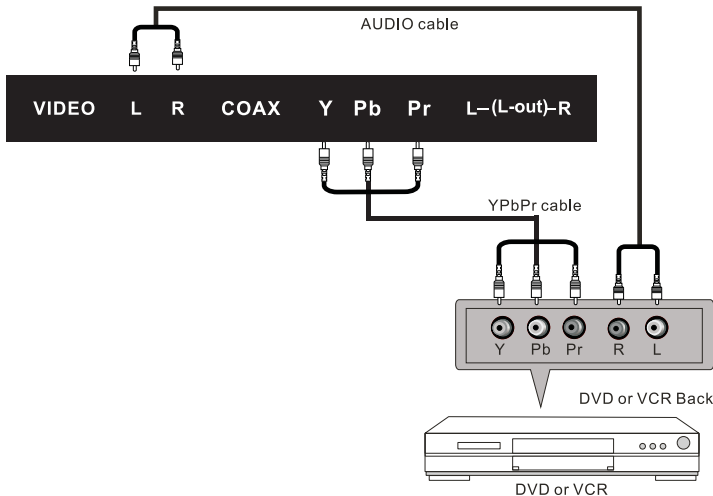

VGA(PC) Connection

Connect the RGB output of a PC to the VGA(PC) jack on the TV. Connect the AUDIO output of a PC to the PC AUDIO jack on the TV. Select the PC input source with the INPUT button on the remote control.

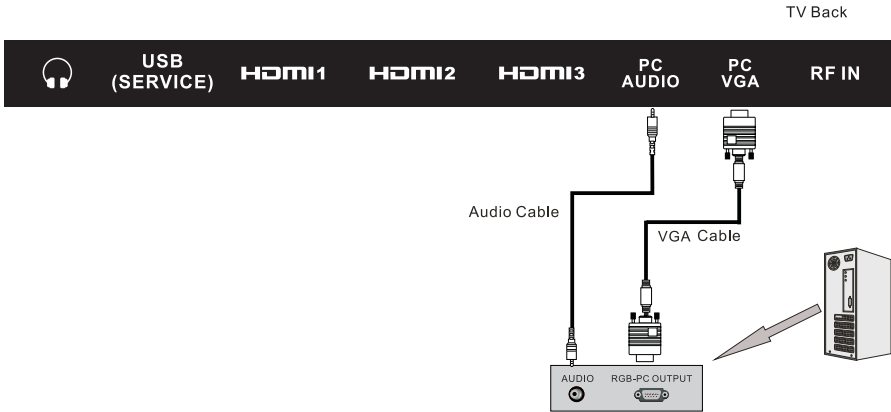

COAX Connection

Connect to Audio Amplifier device to the COAX output jack on the TV.

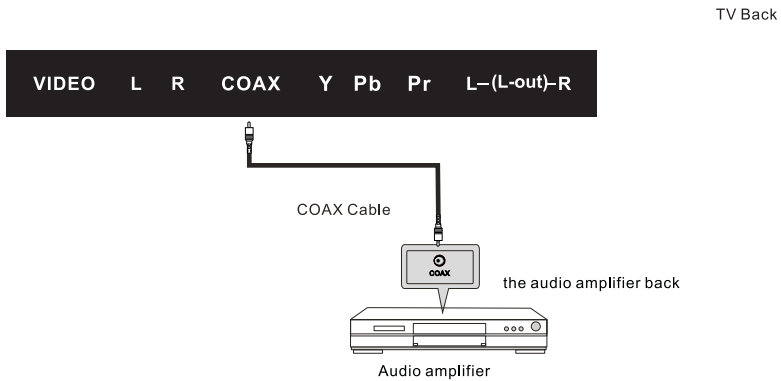

HDMI Connection

HDMI plug which replaces the HDMI connection allows transfer of all audio/video/control signals through one cable only. These signals are transferred in digital.

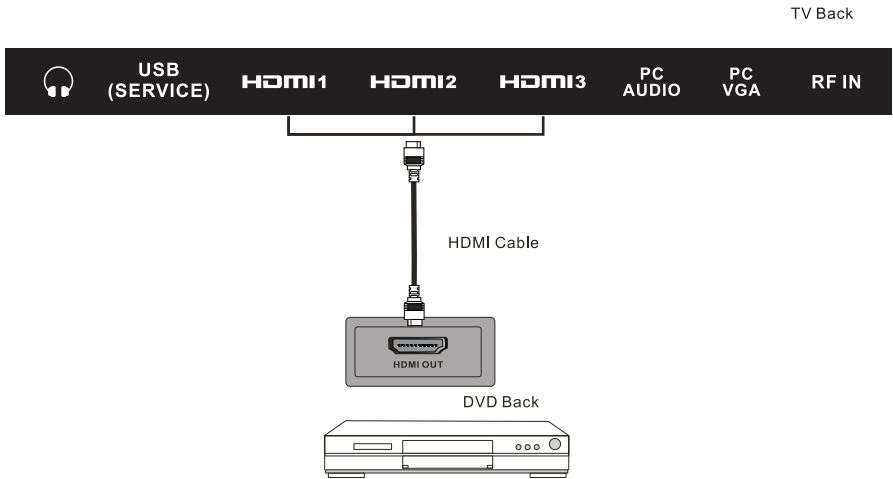

Service Port Function

Service port: (For factory use only)

USB output: DC 5V --- 500mA



8. REMOTE CONTROL

Remote control instructions in TV mode



Mute button (🔇)
Mutes or unmutes audio.
Standby button (🔌)
Control TV to standby or on.

TV button
Quickly switch input to TV source.
YPbPr1 button
Quickly switch input to YPbPr1 source.
Video1 button
Quickly switch input to Video1 source.
HDMI1 button
Quickly switch input to HDMI1 source.
PC button
Quickly switch input to VGA mode.
YPbPr2 button Not used.
Video2 button Not used.
HDMI2 button
Quickly switch input to HDMI2 source.
P Mode button (📺)
Quickly switch the predetermined picture mode.
Energy Star/Retail/Movie/User.
C.C button
Turn on Closed Caption or off, Available at TV/AV.
Sleep button (⏸)
Sets a delay after which the TV switches to standby.
MTS button
Switch sound channel. *Sports/User/Standard/Music/Movie* when analog channel. English and other languages when digital channel.
Favorite button
Single push ▶ switch to FAV channel A/B/C/D;
push and hold ▶ store current channel in A/B/C/D.
Menu button (☰)
Press to display the menu.
Previous Channel/Return button (◀)
Jump to last channel entered by user.
THUMBSTICK (▲/▼/◀/▶/ENTER)
Allows you to navigate the on-screen menus and adjust the system settings to your preference.
Info button (ℹ) only for DTV
Press to display the channel information.
Info button (ℹ)
Display information about the TV channel or accessory device.
Vol+/Vol- button
Adjust speaker volume level.
Input button
Display all source list.
Aspect button (◻)
Press to select Aspect Ratio.
CH+/CH- button
Switches to the next or previous channel.
Digit(0-9), Dot buttons
Input the channel number or password.
When switch to a digital channel, usually should be followed by Dot button and minor channel number. Enter button to confirm.
Enter button
Confirm a selection.
▶ Not used.
▶ Not used.
▶ Not used.
▶ Not used.

English

Remote control setup

1. Open the cover.
2. Uses AAAsize batteries. When inserting the batteries, make sure correct polarities "+" and "-" marks on the batteries line up correctly with compartment markings.
3. Replace the battery cover.

To prevent battery leakage which may result in bodily injury or damage to the remote:

1. Install all batteries correctly, and as marked on the remote control.
2. Do not mix batteries: (OLD and NEW or CARBON and ALKALINE, etc)
Remove batteries when the remote is not used for a long period of time.



9. MENU OPERATION

SETUP WIZARD

Select Language

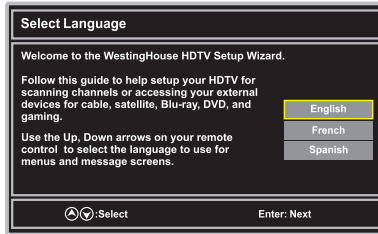

Time zone

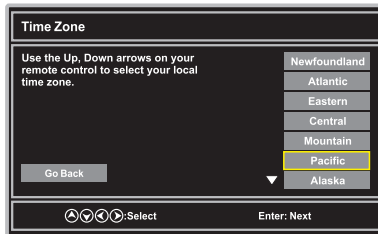

Power On Mode

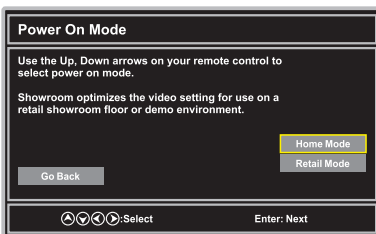

Enter

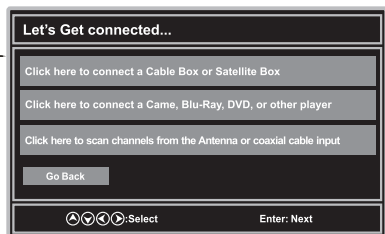

Channel Scan

English

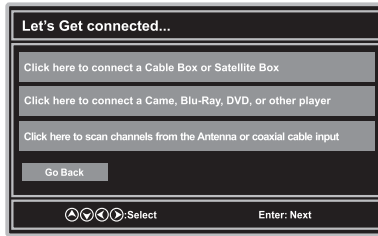

Antenna

Cable/
Satellite

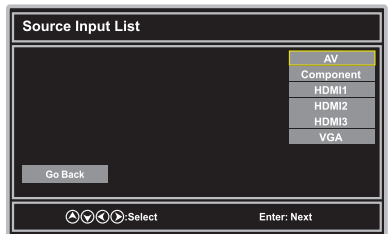
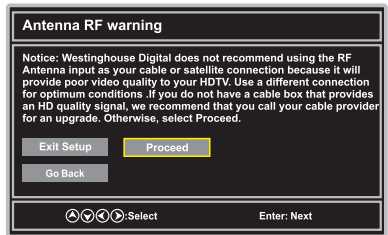
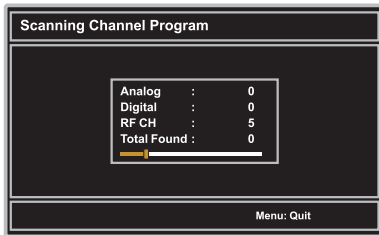
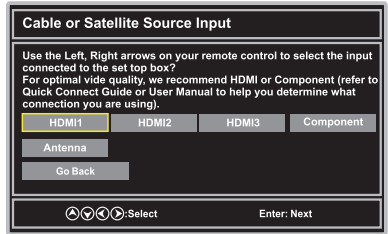
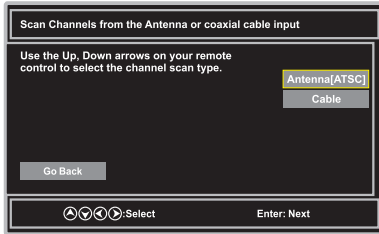

SELECT INPUT SOURCE



- Press **SOURCE** button to display the input source list.
- Press **▼/▲** button to select the input source you want to watch.
- Press **ENTER** button to enter the selected source.

BASIC OPERATION



- Press **MENU** button to display the MAIN OSD MENU.
- Press **◀/▶** button to select the MENU you want.
- Press **ENTER** button to enter the sub menu.
- Press **▼/▲** button to select the option and then press **◀/▶** to adjust the value in the sub menu.
- You can press **MENU** button to go back to the upper menu or **EXIT** button to close the OSD.

For TV Mode:

PICTURE MENU

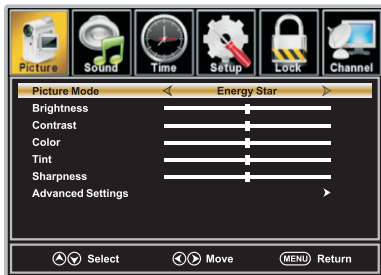

1. Press ◀/▶ button to select **Picture** in the main menu.
2. Press ▼/▲ button to select the option that you want to adjust in the Picture menu.
3. Press ◀/▶ button to desired level.
4. When you have changed the settings, you can exit from the menu by pressing MENU.

Picture Mode

Press ▼/▲ button to select Picture Mode, then press ◀/▶ button to adjust. Only in the User mode, the detail options as following can be adjusted. Available picture mode: Energy Star, Retail, Movie, User.

Brightness

Press ▼/▲ button to select Brightness, then press ◀/▶ button to adjust.

Contrast

Press ▼/▲ button to select Contrast, then press ◀/▶ button to adjust.

Color

Press ▼/▲ button to select Color, then press ◀/▶ button to adjust.

Tint

Press ▼/▲ button to select Tint, then press ◀/▶ button to adjust.

Sharpness

Press ▼/▲ button to select Sharpness, then press ◀/▶ button to adjust.

Advanced Settings

Press ▼/▲ button to select Advanced Settings, then press ENTER button to enter. Adjust advanced video features to fine tune the picture.

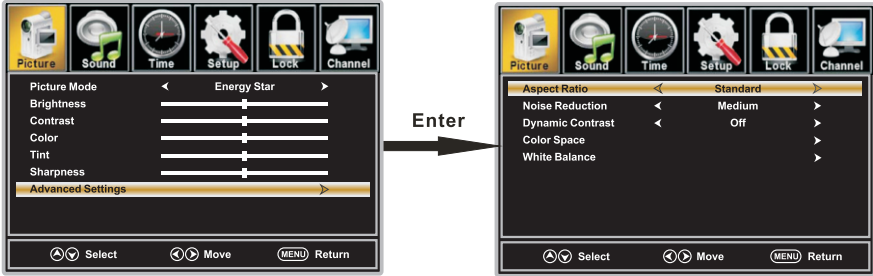

Aspect Ratio

Press ▼/▲ button to select Aspect Ratio, then press ◀/▶ button to adjust. Available Aspect Ratio: Standard, Fill, Over Scan.

Noise Reduction

Press ▼/▲ button to select the item Noise Reduction, then press ◀/▶ button to adjust. Available Noise Reduction: Off, Low, Medium, High.

Dynamic Contrast

Press ▼/▲ button to select Dynamic Contrast, then press ◀/▶ button to adjust On or Off. It can adjust the contrast corresponding to the input signal in order to improve the picture quality displayed.

Color Space

Press ▼/▲ button to select Color Space, then press ENTER button to enter.

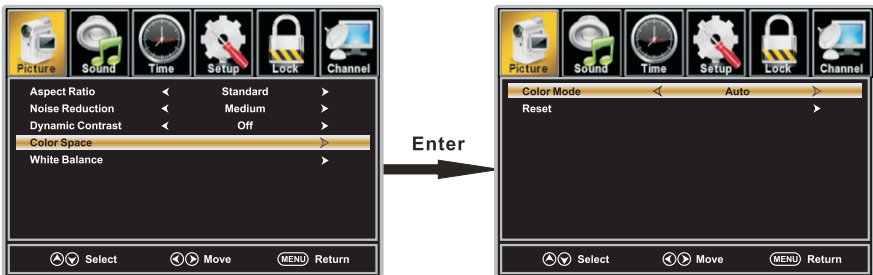

MENU OPERATION

Color Mode

Press ▼/▲ button to select Color Mode, then press ◀/▶ button to adjust. Available Color Mode: Auto, Native, Customer.

Color

Press ▼/▲ button to select Color, then press ◀/▶ button to adjust. Available Color Mode: Red, Green, Blue, Yellow, Cyan, Magenta.(It is available in Customer mode.)

Hue

Press ▼/▲ button to select Hue, then press ◀/▶ button to adjust.(It is available in Customer mode.)

Saturation

Press ▼/▲ button to select Saturation, then press ◀/▶ button to adjust.(It is available in Customer mode.)

Brightness

Press ▼/▲ button to select Brightness, then press ◀/▶ button to adjust.(It is available in Customer mode.)

Reset

Press ▼/▲ button to select Reset, Press ENTER to enter, then press ◀/▶ button to select No or Yes.

White Balance

Press ▼/▲ button to select White Balance, then press ENTER button to enter.

Press ▼/▲ button to select, then ◀/▶ button to adjust.

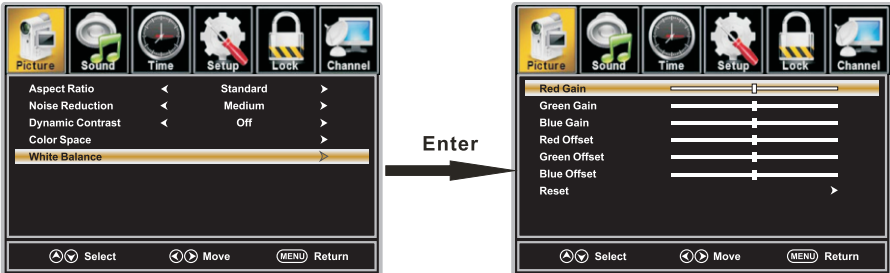

SOUND MENU

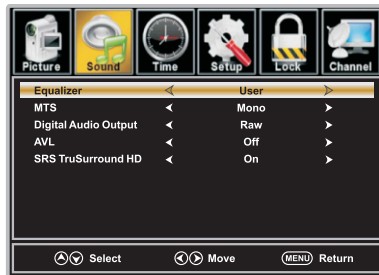

1. Press **◀/▶** button to select **Sound** in the main menu.
2. Press **▼/▲** button to select the option that you want to adjust in the Sound menu.
3. Press **◀/▶** button to desired level.
4. When you have changed the settings, you can exit from the menu by pressing MENU.

Equalizer

Press **▼/▲** button to select the item Equalizer, then press **◀/▶** button to select the desired. Available Equalizer: Sports, User, Standard, Music, Movie. Select a sound mode to achieve ideal sound.

Bass

Press **▼/▲** button to select Bass, then press **◀/▶** button to adjust. (It is available in User mode.)

Treble

Press **▼/▲** button to select Treble, then press **◀/▶** button to adjust. (It is available in User mode.)

Balance

Press **▼/▲** button to select Balance, then press **◀/▶** button to adjust. (It is available in User mode.)

MTS

Press **▼/▲** button to select the item MTS, then press **◀/▶** button to select the desired. Available MTS: Mono, Stereo, SAP. Configures the multi-track sound, it is only available in ATV.

Digital Audio Output

Press **▼/▲** button to select the item Digital Audio Output, then press **◀/▶** button to select the desired digital audio output. Available digital audio output: PCM, Raw and Off.

AVL

Press **▼/▲** button to select the item AVL, then press **◀/▶** button to select ON or OFF. Auto Volume Level can set the volume automatically adjust corresponding to the input audio.

SRS TruSurround HD

Press **▼/▲** button to select the item SRS TruSurround HD, then press **◀/▶** button to select On or Off. SRS TruSurround HD™ creates an immersive, feature-rich surround sound experience from two speakers, complete with rich bass, high frequency detail and clear dialog.

TIME MENU



1. Press ◀/▶ button to select **Time** in the main menu.
2. Press ▼/▲ button to select the option that you want to adjust in the Time menu.
3. Press ◀/▶ button to desired level.
4. When you have changed the settings, you can exit from the menu by pressing MENU.

Sleep Time

Press ▼/▲ button to select Sleep Time, then press ◀/▶ button to set.
 Available Sleep Time: Off, 5Min, 10Min, 15Min, 30Min, 60Min, 90Min, 120Min, 180Min, 240Min.

Time Zone

Press ▼/▲ button to select Time Zone, then press ◀/▶ button to set. Available Time Zone: Central, Mountain, Pacific, Alaska, Hawaii, Samoa, Newfoundland, Atlantic, Eastern.

Daylight Saving Time

Press ▼/▲ button to select Daylight Saving Time, then press ◀/▶ button to set is On or Off.

Time Format

Press ▼/▲ button to select Time Format, then press ◀/▶ button to set.
 Available Time Format: 12-hour, 24-hour.

Auto Clock

Press ▼/▲ button to select Auto Clock, then press ◀/▶ button to set it On or Off, If you set it On, it will adjust the time corresponding the DTV time automatically.

SETUP MENU



1. Press ◀/▶ button to select **Setup** in the main menu.
2. Press ▼/▲ button to select the option that you want to adjust in the Setup menu.
3. Press ◀/▶ button to desired level.
4. When you have changed the settings, you can exit from the menu by pressing MENU.

Menu Language

Press ▼/▲ button to select the item Menu Language, then press ◀/▶ button to adjust.
Available Language: English, French, Spanish.

OSD Time out

Press ▼/▲ button to select OSD Time out, then press ◀/▶ button to set.
Available OSD Time out: 5Sec., 15Sec., 30Sec., 45Sec., 60Sec..

Closed Caption

Press ▼/▲ button to select Closed Caption, then press ENTER button to enter.

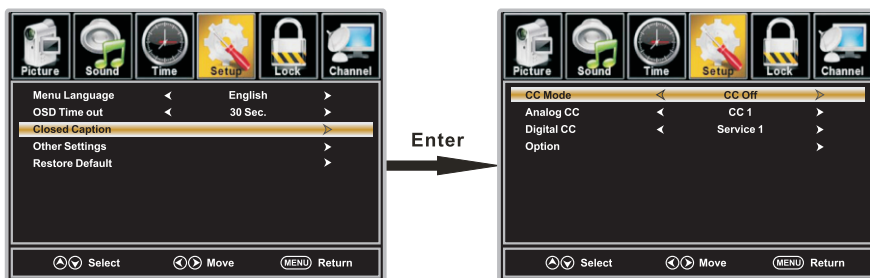

CC Mode

Press ▼/▲ button to select CC Mode, then press ◀/▶ button to select CC Off, CC On, CC on Mute.

Analog CC

Press ▼/▲ button to select Analog CC, then press ◀/▶ button to select.

Available Analog CC: CC1, CC2, CC3, CC4, Text1, Text2, Text3, Text4.

Digital CC

Press ▼/▲ button to select Digital CC, then press ◀/▶ button to select.

Available Digital CC: Service1~6, Off.

Option

Press ▼/▲ button to select Option, then press ENTER button enter.

Press ◀/▶ button to select.

Other Settings

Press ▼/▲ button to select Other Settings, then press ENTER button to enter.

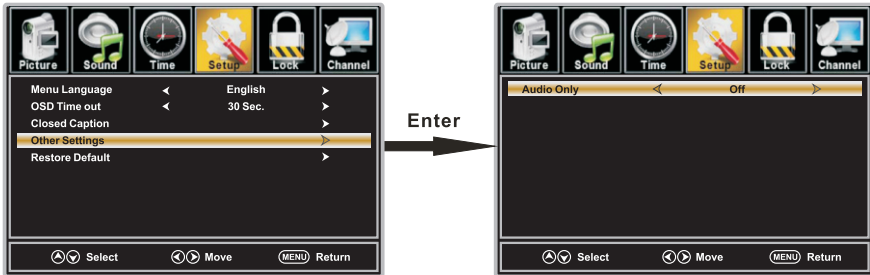

Audio Only

Press ▼/▲ button to select Audio Only, then press ◀/▶ button to set is On or Off.

Restore Default

Press ▼/▲ button to select Restore Default, then press ENTER button to select No or Yes.

Change power on options or reset TV to factory default.

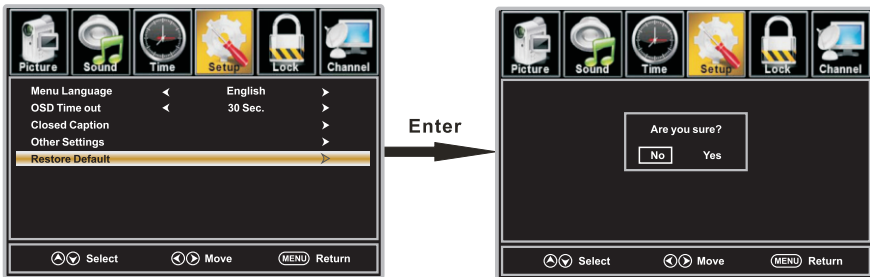

LOCK MENU

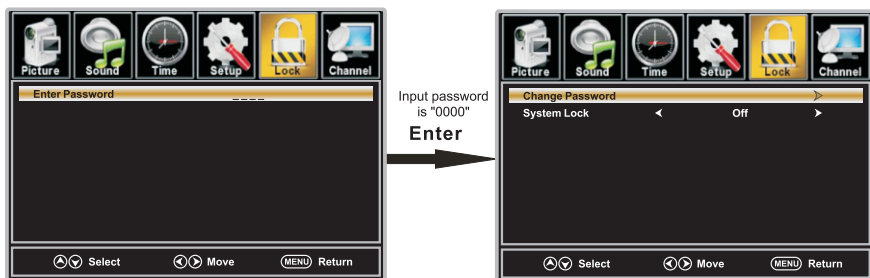

1. Press ◀/▶ button to select **Lock** in the main menu.
2. Press ▼/▲ button to select the option that you want to adjust in the Lock menu.
3. Press ◀/▶ button to desired level.
4. When you have changed the settings, you can exit from the menu by pressing MENU.
Input password to enter, default password is "0000".

Change Password

Press ▼/▲ button to select Change Password, then press ENTER button to adjust the value. A Sub Menu Will appear as below. If the password is changed, all of the passwords in the menu will be changed at the same time.

Note: If you forget your password, you can use "1470" to enter any menu locked.

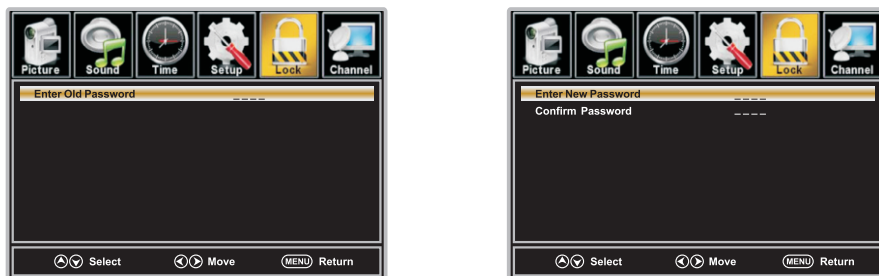

System Lock

Press ▼/▲ button to select System Lock, then press ◀/▶ button to set is On or Off.
Only available when "System Lock" is "On".

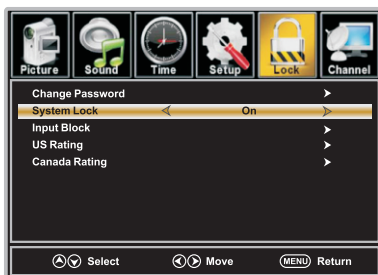

Input Block

Press ▼/▲ button to select Input Block, then press ◀/▶ button to enter.
 Press ◀/▶ button to select Unblock or Block the input sources.

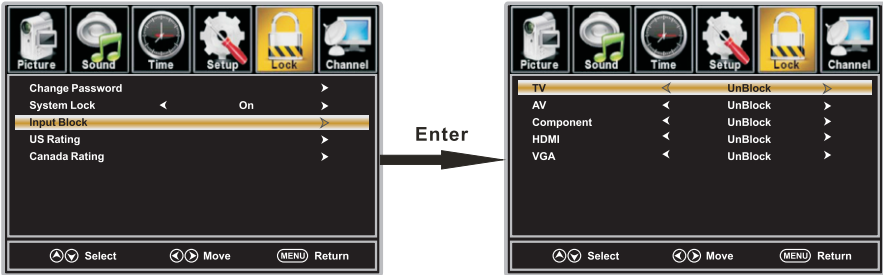

US Rating

Press ▼/▲ button to select US Rating, then press ◀/▶ button to enter. A sub menu will appear as below.
 The TV rating compose of two aspects: age-based and content -based.
 This system defines the rating control which come from MPAA rules.

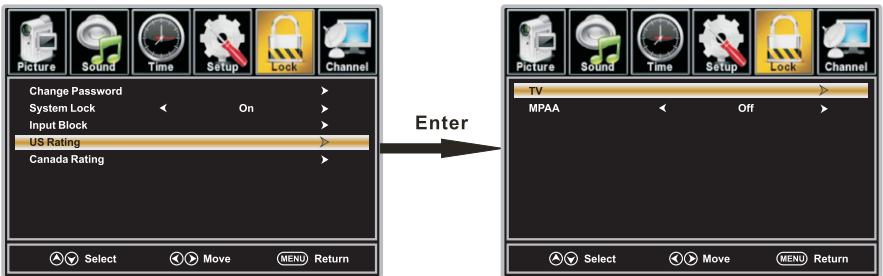

Canada Rating

Press ▼/▲ button to select Canada Rating, then press ◀/▶ button to enter. Press ◀/▶ button to select.

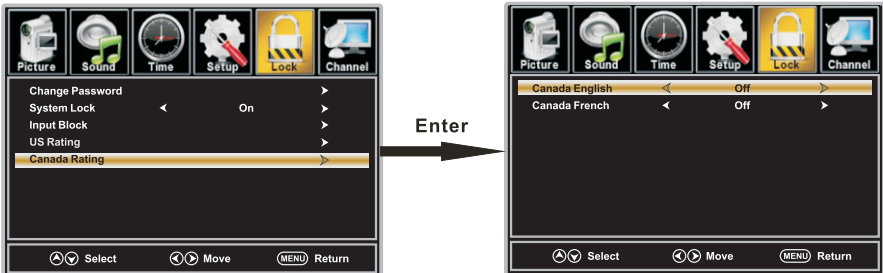

Canada English

Press ▼/▲ button to select Canada English, then press ◀/▶ button to set.
 Available Canada English: Off, C, C8+, G, PG, 14+, 18+.

Canada French

Press ▼/▲ button to select Canada French, then press ◀/▶ button to set.
 Available Canada French: Off, G, 8ans+, 13ans+, 16ans+, 18ans+.

CHANNEL MENU

Note: This menu is only shown when the input source is TV.

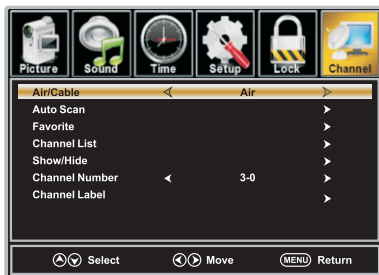

1. Press ◀/▶ button to select **Channel** in the main menu.
2. Press ▼/▲ button to select the option that you want to adjust in the Channel menu.
3. Press ◀/▶ button to desired level.
4. When you have changed the settings, you can exit from the menu by pressing MENU.

Air/Cable

Press ▼/▲ button to select Air/Cable, then press ◀/▶ button to set. Available Air/Cable: Air, Cable.

Auto Scan

Press ▼/▲ button to select Auto Scan, then press ENTER button to search channel.

A Channel Search Menu will appear as below.

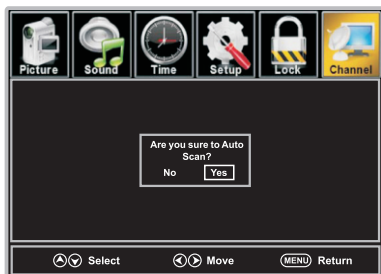

Favorite

Press ▼/▲ button to select Favorite, then press ENTER button to scan the Favorite channel list.



Channel List

Press ▼/▲ button to select Channel List, then press ENTER button to scan the Channel List. If you select the option "In Channel List" On, the channel label will display in the list.



Show/Hide

Press ▼/▲ button to select Show, then press ENTER button to enter . Show or hide the channels in your program list.

Channel Number

Press ▼/▲ button to select Channel Number, then press ◀/▶ button to adjust.

Channel Label

Press ▼/▲ button to select Channel Label, then press ENTER button to enter. Create labels for channels, up to 7 characters.



PICTURE MENU

For VGA Mode:

1. Press ◀/▶ button to select **Picture** in the main menu.
2. Press ▼/▲ button to select VGA Settings, then press ENTER button to enter.
A sub menu will appear as below.

English

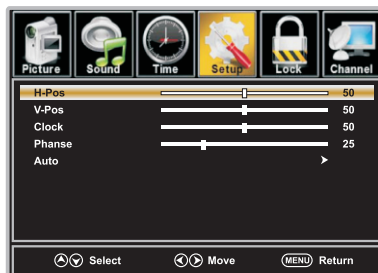

H-Pos

Press ▼/▲ button to select H-Pos, then press ◀/▶ button to adjust.

V-Pos

Press ▼/▲ button to select V-Pos, then press ◀/▶ button to adjust.

Clock

Press ▼/▲ button to select Clock, then press ◀/▶ button to adjust.

Phase

Press ▼/▲ button to select Phase, then press ◀/▶ button to adjust.

Auto

Press ▼/▲ button to select Auto, then press ENTER button to enter.
Adjust to the PC signal timing automatically.

1. PICTURE menu and description are the same as that for TV mode.
2. Audio Language in SOUND menu is invalid.
3. TIME menu and description are the same as that for TV mode.
4. Close Caption in SETUP menu is invalid.
5. US, Canada, RRT Setting and Reset RRT in LOCK menu is invalid
6. PC mode has no CHANNEL menu.

Note: The operation and description of the hot key is programmable on your remote control.

10. Troubleshooting

Please check if you can solve problems by troubleshooting yourself.

Troubleshooting	Control
No signal	Please check that all cables are correctly plugged in.
No color shades	Adjust the contrast, the color and the brightness.
Stain on the screen	May be the result from a lighting signal from car, motor, neon light and other electrical devices or appliances.
Double or multiple display image	May be the result of an electrical wave disturb from other TV, Computer and Game machine or Radio.
Snow on the screen	The cables of the antenna are not correctly plugged in.
The remote control does not work	Please check the batteries order and alignment. Check that the IR of the remote control is not hidden by something.
"Zip" made noise on TV cover	Even if the display image is correct, the noise may come from an unsteady fixation of the panel.
No sound	Make sure that you have not press the MUTE button of the panel or of the remote control.

11. SPECIFICATIONS

This manual is only for your reference, any change to the design and specification will not be advised.

Screen Size		40 Inch
Display Type		TFT LED
Resolution(Pixel)		1920 X 1080
Aspect Ratio		16:9
Power Supply		AC100-240V~ 50/60Hz
Power Consumption		90W
TV System		ATSC/NTSC
Video Input Format		PAL/NTSC
Audio Output Power		L / R 2X8W
SUPPORT	TUNER	YES
	AV-IN	YES
	YPbPr - IN	YES
	HDMI - IN	YES
	VGA(PC) - IN	YES
	VGA(PC) AUDIO - IN	YES
	Audio Input(RCA)	YES
	Audio Output(RCA)	YES
	COAXIAL - OUT	YES
	USB	Service Port Only
Dimensions	w / Stand (LxWxH-mm)	973 x 230 x 658mm
	w / o Stand (LxWxH-mm)	973 x 69 x 605mm
Weight	Net (Kgs)	15.5
	Gross (Kgs)	17.3



www.westinghousedigital.com

┌
S/N: _____
└

Westinghouse Digital, LLC
Orange, CA

SE-UM-4006-1202

Free Manuals Download Website

<http://myh66.com>

<http://usermanuals.us>

<http://www.somanuals.com>

<http://www.4manuals.cc>

<http://www.manual-lib.com>

<http://www.404manual.com>

<http://www.luxmanual.com>

<http://aubethermostatmanual.com>

Golf course search by state

<http://golfingnear.com>

Email search by domain

<http://emailbydomain.com>

Auto manuals search

<http://auto.somanuals.com>

TV manuals search

<http://tv.somanuals.com>