

User Manual

Toaster Oven

MODEL: WTO1010B/W

1. READ these instructions carefully before installing and operating the toaster oven.
Keep them for further reference.
2. Record in the space below the "SERIAL NO." found on the nameplate on your toaster oven and retain this information for future reference.

SERIAL NO.:

Please save sales receipt for warranty.



Westinghouse

INNOVATION YOU CAN BE SURE OF

CONTENTS

SAFETY INFORMATION

Important Safety Instructions	3
Electrical Requirements	5

SET UP & USE

Specifications	6
Installation Guide	6
Parts & Features	6
Operation Instructions	7

CLEANING & CARE	9
-----------------------	---

TROUBLE SHOOTING & WARRANTY

Before You Call For Service	10
Customer Service	10
Troubleshooting	10
Limited Warranty	11

PRODUCT REGISTRATION

Thank you for purchasing our Westinghouse product. This easy-to-use manual will guide you in getting the best use of your toaster oven.

Remember to record the model and serial numbers. They are on a label on the back of the toaster oven.

Staple your receipt to your manual. You will need it to obtain warranty service.

Model number

Serial number

Date of purchase

SAFETY INFORMATION

DANGER

DANGER - Immediate hazards which **WILL** result in severe personal injury or death

WARNING

WARNING - Hazards or unsafe practices which **COULD** result in severe personal injury or death

CAUTION

CAUTION - Hazards or unsafe practices which **COULD** result in minor personal injury

IMPORTANT SAFETY INSTRUCTIONS

WARNING

When using electrical appliances, basic safety precautions should be followed, including the following

1. Read all instructions
2. Do not touch hot surfaces. Use handles or knobs.
3. To protect against electrical shock do not immerse cord, plugs, in water or other liquid.
4. Close supervision is necessary when any appliance is used by or near children.
5. Unplug from outlet when not in use and before cleaning. Allow to cool before putting on or taking off parts.
6. Do not operate any appliance with a damaged cord or plug or after the appliance malfunctions or has been damaged in any manner. Return appliance to the nearest authorized service facility for examination, repair, or adjustment.
7. The use of accessory attachments not recommended by the appliance manufacturer may cause injuries.
8. Do not use outdoors.
9. Do not let cord hang over edge of table or counter, or touch hot surfaces.
10. Do not place on or near a hot gas or electric burner, or in a heated oven.
11. Extreme caution must be used when moving an appliance containing hot oil or other hot liquids.
12. To disconnect, turn any control to "OFF," then remove plug from wall outlet.
13. Do not use appliance for other than intended use.
14. Oversize foods or metal utensils must not be inserted in a toaster-oven as they may create a fire or risk of electric shock.

SAFETY INFORMATION

15. A fire may occur if the toaster-oven is covered or touching flammable material, including curtains, draperies, walls, and the like, when in operation. Do not store any item on top of the appliance when in operation.
16. Do not clean with metal scouring pads. Pieces can break off the pad and touch electrical parts involving a risk of electric shock.
17. Extreme caution should be exercised when using containers constructed of other than metal or glass.
18. Do not store any materials, other than manufacturers recommended accessories, in this oven when not in use.
19. Do not place any of the following materials in the oven: paper, cardboard, plastic, and other similar products.
20. Do not cover crumb tray or any part of the oven with metal foil. This will cause overheating of the oven.
21. This appliance is not intended for use by persons (including children) with reduced physical, sensory or mental capabilities. Or lack of experience and knowledge unless they have been given supervision or instruction concerning use of the appliance by a person responsible for their safety.
22. Use extreme caution when removing tray or disposing of hot grease.
23. This appliance has a tempered, safety glass door. The glass is stronger than ordinary glass and more resistant to breakage. Tempered glass can break, but pieces will not have sharp edges. Avoid scratching door surface or nicking edges.
24. Do not place eyes or face in close proximity with tempered safety glass door in event that safety glass breaks
25. This appliance is OFF when both Time/Toast and Temperature controls are in OFF position.

SAVE THESE INSTRUCTIONS
HOUSEHOLD USE ONLY

SAFETY INFORMATION

ELECTRICAL REQUIREMENTS

This appliance has a polarized plug (one blade is wider than the other). To reduce the risk of electric shock, this plug is intended to fit into a polarized outlet only one way. If the plug does not fit into the outlet, reverse the plug. If it still does not fit, contact a qualified electrician. Do not attempt to modify the plug in any way.

NOTE: This appliance requires a minimum of 1000 watts and it should be the only appliance operating on the circuit.

POWER SUPPLY CORD

1. A short power supply cord is provided to reduce the risk of becoming entangled in or tripping over a longer cord.
2. If the power supply cord is too short, do not use an extension cord. Have a qualified electrician or serviceman to install an outlet near the appliance.
3. If it is absolutely necessary to use longer cord sets or an extension cord, extreme care must be exercised.
 - a) Use an extension cord rated no less than 10-amperes.
 - b) The marked electrical rating of the cord set or extension cord must equal to or be greater than the electrical rating of the appliance. The longer cord should be arranged so that it will not drape over the counter top or table top where it can be pulled on by children or tripped over unintentionally.

NOTE: Neither Westinghouse nor the dealer can accept any liability for damage to the product or personal injury resulting from failure to observe the electrical connection procedures.

SET UP & USE

SPECIFICATIONS

- Power: 1000W
- Outside Dimensions (W x D x H): 14.57" x 11.42" x 7.95"
- Oven Cavity Dimensions (W x D x H): 10.24" x 9.06" x 6.55"
- Oven Capacity: 0.35 cu. ft.
- Net Weight: Approx. 6.16 lbs.

INSTALLATION GUIDE

1. Make sure that all the packing materials are removed from the inside of the door.
2. Check the oven for any damage, such as misaligned door, damaged door and sealing surfaces, broken or loose door hinges, and dents inside the cavity. If there is any damage, do not operate the oven. Contact qualified service personnel.
3. This toaster oven must be placed on a flat, stable surface capable of supporting the weight of the oven plus the heaviest food likely to be cooked in the oven.
4. Do not place the oven where heat, moisture, or high humidity are generated, or near combustible materials.
5. To function correctly, the oven must have sufficient airflow on all sides. Allow 8" of space above the oven, 4" at back, and 2" at both sides. Do not cover or block any openings on the appliance. Do not remove feet on which oven stands.
6. Make sure that the power supply cord is undamaged and does not run under the oven or over any hot or sharp surface.
7. The socket must be readily accessible so that the cord can be quickly reached and easily unplugged in an emergency.

PARTS & FEATURES

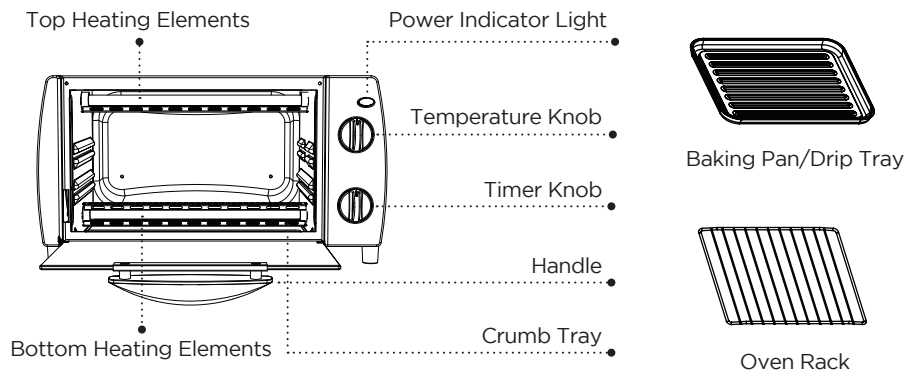

Diagram for instructional purposes only.

SET UP & USE

OPERATION INSTRUCTIONS

BEFORE FIRST USE

1. Remove all accessories and shipping materials packed inside the oven.
2. Wash the rack and pan in warm soapy water. Wipe the inside of the oven with a damp cloth or sponge. Blot dry with paper towels to be sure the unit is dry before using.
3. Place oven on a flat counter or other stable surface DO NOT OPERATE ON THE SAME CIRCUIT WITH ANOTHER APPLIANCE.
4. Position the oven so that it is at least 2 inch (5cm) on both sides and 4" at the back from any object. Ensure that nothing has been placed on top of the oven.
5. Make sure the crumb tray is properly in place before using. For the first time only, turn the temperature knob to 450 F and the timer knob to 15 minutes. This will burn off any oils still on the oven.

NOTE: The oven may smoke during this process. This is normal for a new oven and will not last more than 10-15 minutes.

TOASTING

Rotate the temperature knob clockwise to "TOAST" position. Open the oven door and place the bread slice on the oven rack. If a single slice of bread is toasted, place it in the center of the oven rack. If 4 slices are being toasted, place them side by side.

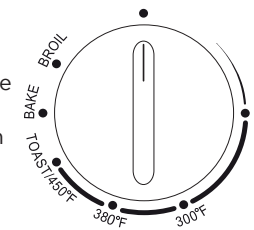

TIME SETTING

Choose your crust preference by rotating the timer knob clockwise to select toasting time. Start toasting at short time period, as toasting varies according to humidity, thickness and texture, each type of bread will toast differently according to these properties.

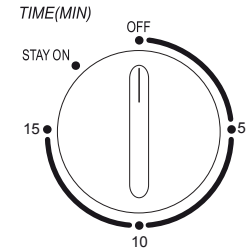

NOTE: For cooking times which are under ten minutes, first rotate the timer to a longer time and then turn the knob back to the time you require. When the toast cycle is finished a bell will ring and the electrical power will automatically turn off. To stop the cycle at any time, rotate the timer knob counterclockwise to "OFF" position till the bell rings.

Bread may catch fire if the toasting time is set for a very long period. Close supervision is necessary during toasting. In the "TOAST" setting, both the heating elements will work.

BROILING

1. Slide in the drip tray under the oven rack. Always use the drip tray when broiling the food like chicken wings or drumstick which contains fat.
2. Place food on the oven rack. In "BROIL" setting, only top heating element will work.

NOTE: We always suggest preheating oven about 3-5 minutes before placing the food in the oven.

SET UP & USE

3. Rotate the temperature knob clockwise to "BROIL" position
4. The timer knob is in OFF position.
 - a) For short time broiling, rotate the timer knob clockwise (up to 15 minutes), when the cycle is finished, the bell will ring and the power is automatically turned off.
 - b) For longer time broiling, rotate the time knob counterclockwise from the OFF position to "STAY ON" setting. The cooking will continue until the timer knob is manually turned to "OFF" position and the bell will ring.

NOTE: · Always monitor the food at this setting to prevent overcooking. Turn the food over during the process or add the flavoring as necessary. Always use oven mitts to prevent the risk of scalding.

BAKING

1. Slide the baking pan into the bottom rack level.
2. Place food on the baking pan.

NOTE: · We always suggest preheating oven 5 minutes at this setting before place the food in the oven.

3. Rotate the temperature knob clockwise to "BAKE" position.
4. Set the time based on the food type and thickness. The heating element will cycle on and off to maintain a constant cavity temperature. The maximum time that can be set by timer is 15 minutes, if longer time is needed, you must set the timer to "STAY ON" position. Rotate the time knob counterclockwise from the OFF position. In this case you must

stop the oven manually by turning the timer knob to OFF position once the food is ready.

NOTE: · Always monitor the food at this setting to ensure that you are not overcooking.

ABOUT RACK LEVELS

There are 2 rack levels. The baking pan or oven rack can be slid into the groove for either level.

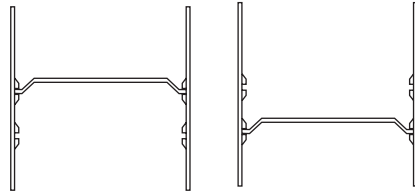

Upper Rack Level

Lower Rack Level

CLEANING AND CARE

1. Before cleaning unplug the toaster oven and allow it to cool completely.
2. Wash all the attachments with mild, soaped water.
3. Do not use abrasive cleansers, scrubbing brushes and chemical cleaner as this will cause damage to the non-stick coating of baking pan.
4. Using a wet cloth to wipe the inner of the oven.
5. Clean the door by using a wet cloth saturated with detergent or soap.
6. Never immerse the unit in water or other liquid.
7. Any other servicing should be performed by an authorized service representative.

CLEANING THE BOTTOM OF THE CRUMB TRAY

This appliance has a drop open crumb tray at the bottom of the baking chamber. First unplug this appliance and allow the oven to cool down. To clean out the crumbs, simply tilt the unit backwards and push the crumb tray slide knob towards the rear. This will release the crumb tray and allow it to tilt down on the counter. Wipe interior of crumb tray with a damp cloth. After cleaning, simply push the knob towards the rear and place the crumb tray in its position. Washing of the interior of the crumb tray is accomplished by placing unit on its back side and allow crumb tray to fall forward for easy cleaning.

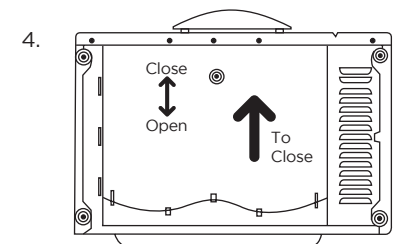
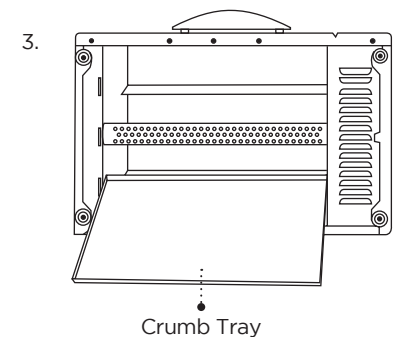
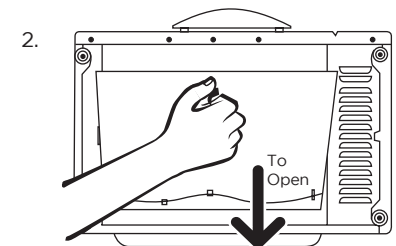
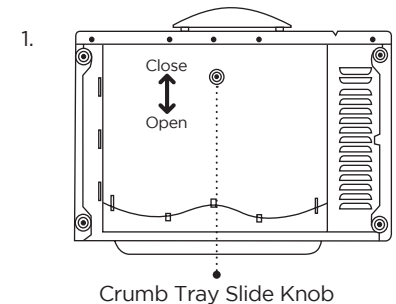

TROUBLESHOOTING & WARRANTY

BEFORE YOU CALL FOR SERVICE

IF THE OVEN FAILS TO OPERATE:

- A) Check to make sure that the oven is plugged in securely. If it is not, remove the plug from the outlet, wait 10 seconds and plug it in again securely.
- B) Check for a blown circuit fuse or a tripped main circuit breaker. If these seem to be operating properly, test the outlet with another appliance.

IF NONE OF THE ABOVE SOLVES THE PROBLEM, CONTACT A QUALIFIED TECHNICIAN. DO NOT TRY TO ADJUST OR REPAIR THE OVEN YOURSELF.

CUSTOMER SERVICE

IMPORTANT

DO NOT RETURN THIS PRODUCT TO THE STORE

If you have a problem with this product, please contact the W Appliance Co. Customer Satisfaction Center at 1-855-855-0294.

DATED PROOF OF PURCHASE, MODEL # AND SERIAL # REQUIRED FOR WARRANTY SERVICE

TROUBLESHOOTING

Troubleshoot your problem by using the chart below. If the toaster oven still does not work properly, contact W Appliance Co. customer service center or the nearest authorized service center. Customers must never troubleshoot internal components.

TROUBLE	POSSIBLE CAUSE	POSSIBLE REMEDY
Oven will not start	Electrical cord for oven is not plugged in.	Plug into the outlet.
Unevenly cooked foods	Cooking time, power level is not suitable. Food is not turned or stirred.	Use correct cooking time, power level. Turn or stir food.
Overcooked or undercooked foods	Cooking time, power level is not suitable.	Use correct cooking time and power level.

TROUBLESHOOTING & WARRANTY

LIMITED WARRANTY

Westinghouse brand is used under license. Any repair, replacement, or warranty service, and all questions about this product should be directed to W Appliance Co. at **1 (855) 855-0294** from the USA or Puerto Rico.

W Appliance Co. warrants to the original purchaser that the product will be free from defects in material, parts and workmanship for the period designated for this product. The warranty commences the day the product is purchased and covers up to a period of **1 year (12 months) for labor/1 year (12 months) for parts (manufacturing defects only)/carry in service.** W Appliance Co. agrees that it will, at its option, replace the defective product with either a new or remanufactured toaster oven equivalent to your original purchase during the warranty period.

Exclusions: This warranty does not apply to the below:

1. If the appearance or exterior of the product has been damaged or defaced, altered or modified in design or construction.
2. If the product original serial number has been altered or removed or cannot be readily determined.
3. If there is damaged due to power line surge, user damage to the AC power cord or connection to improper voltage source.
4. If damage is due to general misuse, accidents or acts of God.
5. If repair attempts are done by unauthorized service agents, use of parts other than genuine parts or parts obtained from persons other than authorized service companies.
6. On units that have been transferred from the original owner.
7. On products that have been purchased as refurbished, like new, second-hand, in a "As-Is" or "Final Sale" terms.
8. To products used in a commercial or rental setting.
9. To products used in settings other than ordinary household use or used other than in accordance with the provided instructions.
10. To damages for service calls for improper installations.
11. To glass or replaceable light bulbs or parts and other accessory items that are included with the unit.
12. Transportation and shipping costs associated with the replacement of the unit.
13. Food loss for loss due to product failure or delay in service, repair or replacement.
14. Service calls to instruct you how to use your toaster oven.
15. Service calls to repair or replace the house fuse, reset the circuit breaker or correct the wiring in the house.

REPAIR OR REPLACEMENT AS PROVIDED UNDER THIS WARRANTY IS THE EXCLUSIVE REMEDY OF THE CUSTOMER; W Appliance Co. SHALL NOT BE LIABLE FOR ANY INCIDENTAL OR CONSEQUENTIAL DAMAGES FOR BREACH OF ANY EXPRESS OR IMPLIED WARRANTY ON THIS PRODUCT, EXCEPT TO THE EXTENT PROHIBITED BY APPLICABLE LAW. ANY IMPLIED WARRANTY OF MERCHANTABILITY OF FITNESS FOR A PARTICULAR PURPOSE ON THIS PRODUCT IS LIMITED TO THE DURATION OF THE WARRANTY.

Some states do not allow the exclusion or limitations of incidental or consequential damages, or limitations on how long the warranty lasts. In these cases the above exclusions or limitations may not apply to you. This warranty gives you specific legal rights and you may also have other rights which vary from state to state.

Obtaining Service: To obtain service, product literature, supplies or accessories please call **1 (855) 855-0294** to create a ticket for exchange/repair. Please make sure to provide the date of purchase, model number and a brief description of the problem. Our customer service representative will contact you or send detailed return instructions.

W Appliance Co. does not warrant that the appliance will work properly in all environmental conditions, and makes no warranty and representation, either implied or expressed, with respect to the quality, performance, merchantability, or fitness for a particular purpose other than the purpose identified within this user's manual. W Appliance Co. has made every effort to ensure that this user's manual is accurate and disclaims liability for any inaccuracies or omissions that may have occurred. Information in this user's manual is subject to change without notice and does not represent a commitment on the part of W Appliance Co.. W Appliance Co. reserves the right to make improvements to this user's manual and/or to the products described in this user's manual at any time without notice. If you find information in this manual that is incorrect, misleading, or incomplete, please contact us at **1-855-855-0294**.

W Appliance Co.,
New York, NY 10018



©, WESTINGHOUSE, and INNOVATION YOU CAN BE SURE OF are trademarks of Westinghouse Electric Corporation. Used under license by W Appliance Company. All Rights Reserved.

Free Manuals Download Website

<http://myh66.com>

<http://usermanuals.us>

<http://www.somanuals.com>

<http://www.4manuals.cc>

<http://www.manual-lib.com>

<http://www.404manual.com>

<http://www.luxmanual.com>

<http://aubethermostatmanual.com>

Golf course search by state

<http://golfingnear.com>

Email search by domain

<http://emailbydomain.com>

Auto manuals search

<http://auto.somanuals.com>

TV manuals search

<http://tv.somanuals.com>