

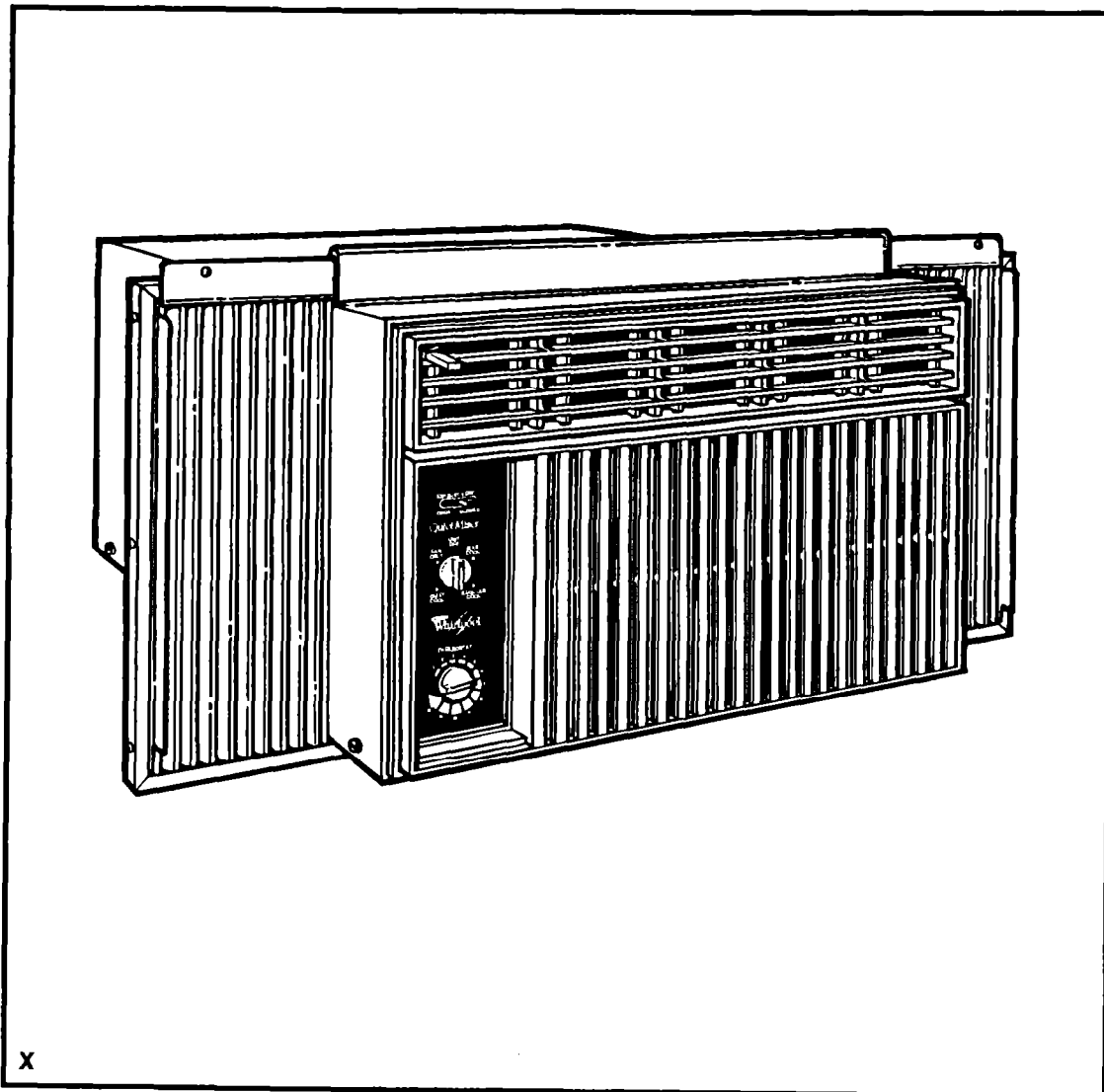

# Use & Care Guide



**AIR CONDITIONERS**  
**ACQ052 ACQ062**

# Contents

	Page
Important Safety Instructions .....	2
Operating Your Air Conditioner .....	3
Starting your air conditioner .....	3
The exhaust control .....	4
Changing air direction .....	4
Cleaning Your Air Conditioner .....	5
Cleaning front panel and filter .....	5
Caring For Your Air Conditioner .....	6
Annual maintenance .....	6
Oiling the fan motor .....	8
Energy saving tips .....	8
If You Need Service Or Assistance .....	9
Whirlpool Room Air Conditioner	
Warranty .....	12

© 1991 Whirlpool Corporation

Thank you for buying a Whirlpool appliance. Please complete and mail the Owner Registration Card provided with this product. Then complete the form below. Have this information ready if you need service or call with a question.

- Copy model and serial numbers from label (see diagram below) and purchase date from sales slip.
- Keep this book and sales slip together in a handy place.

Model Number

Serial Number

Purchase Date

Service Company Phone Number

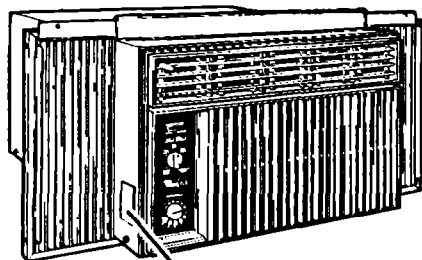

Model and serial number label

# Important Safety Instructions

## ⚠ WARNING

To reduce the risk of fire, electrical shock or personal injury when using your air conditioner, follow these basic precautions:

- Read all instructions before using air conditioner.
- Complete the installation requirements as described in the Installation Instructions.
- Do Not operate the air conditioner with the front panel removed.
- Never clean air conditioner parts with flammable fluids. The fumes can create a fire hazard or explosion.

### • FOR YOUR SAFETY •

**DO NOT STORE OR USE GASOLINE OR OTHER FLAMMABLE VAPORS AND LIQUIDS IN THE VICINITY OF THIS OR ANY OTHER APPLIANCE. THE FUMES CAN CREATE A FIRE HAZARD OR EXPLOSION.**

It is your responsibility to be sure your air conditioner:

- Is installed in a window that will hold the weight, and is secured according to the Installation Instructions.
- Is connected only to the proper kind of outlet, with the correct electrical supply and grounding. (See Installation Instructions.)
- Is the correct size for the area you want to cool.
- Is used only to do what window air conditioners are designed to do.
- Is not used by anyone unable to operate it properly.
- Is properly maintained.

Also, remove Energy Label and Buy Guide. Use a damp cloth to take off any glue residue. Do not use sharp instruments, flammable fluids or abrasive cleaners. These can damage the material.

- SAVE THESE INSTRUCTIONS -

# Operating Your Air Conditioner

## Starting your air conditioner

### **⚠ WARNING**

#### **Electrical Shock Hazard**

- Plug unit only into grounded electrical outlet.
  - Do not use an extension cord.
  - Do not operate unit with front removed.
- Failure to follow the above precautions could result in electrical shock or personal injury.

1. Set Exhaust Control to CLOSED for maximum cooling.
2. Set Fan Speed Control to the desired setting.

**QUIET COOL** ..... for sleeping comfort  
**REGULAR COOL** ..... for normal cooling  
**MAX COOL** ..... for maximum cooling  
**FAN ONLY** ..... for circulating room air when no cooling is desired

3. Turn the Thermostat Control to number 6 (mid-setting). You can adjust the air conditioner's cooling performance by resetting the Thermostat Control to a higher number for more cooling. Lower the number setting for less cooling. You will need to experiment to find the setting which suits you best.

**NOTE:** If you turn your air conditioner off or if the compressor turns off when lowering the Thermostat Control, wait at least 3 minutes before turning it back on or you may blow a fuse or trip a circuit breaker.

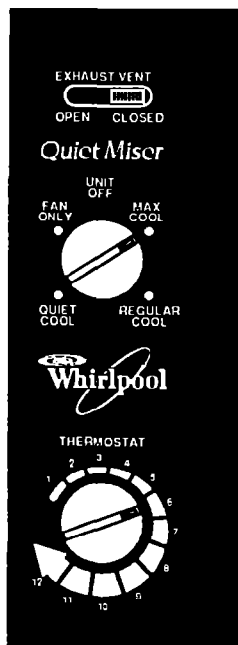

## The exhaust control

The Exhaust Control setting draws stale or smoky air from the room.

### 1. To exhaust room air:

- Set Exhaust Control to OPEN.
- If no cooling is desired, use FAN ONLY setting.
- For cooling, set Fan Speed Control to desired COOL setting.



### 2. To circulate room air:

- Set Exhaust Control to CLOSED.
- If no cooling is desired, use FAN ONLY setting.
- For cooling, set Fan Speed Control to desired COOL setting.

**NOTE:** For maximum performance, the Exhaust Control must be in the CLOSED position when cooling, or room air circulation is desired.

## Changing air direction

The louvers, in the top grille area of the air conditioner, control the direction of the cooled air. Move the tab, at the top of the louvered area, in the direction you want the air to go (right, left or straight ahead).

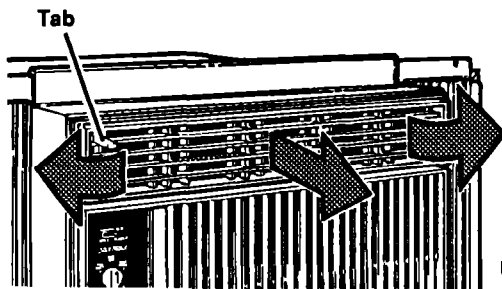

# Cleaning Your Air Conditioner

Proper use and care of your air conditioner will help ensure longer life of the unit and lower operating costs. Follow these instructions carefully. Call your Whirlpool servicing dealer for an annual checkup.

## Cleaning front panel and filter

### **⚠WARNING**

#### **Electrical Shock, Personal Injury and Product Damage Hazard**

- **Unplug power cord from receptacle before cleaning unit. Failure to do so could result in electrical shock or personal injury.**
- **Handle the air conditioner with care. The metal fins on the coils are sharp. Failure to do so could result in personal injury.**
- **Do not use cleaning fluids, solvents, abrasive cleaners, or strong detergents. They may damage the parts.**

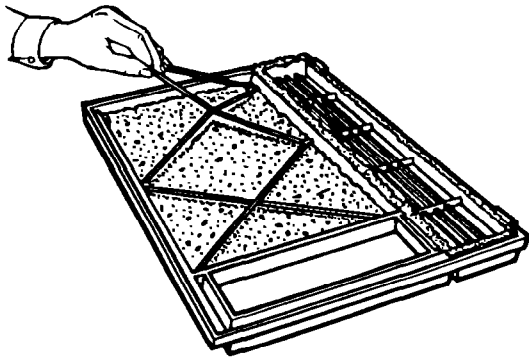
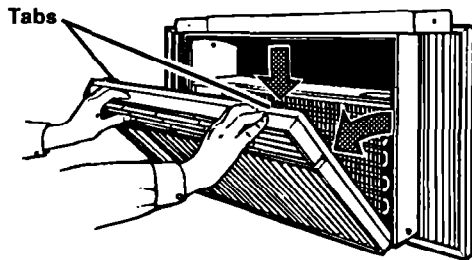

1. Unplug power cord.
2. Remove the front panel from unit for cleaning. Press down at top of front panel to release it from top of cabinet.
3. Pull top of front panel toward you.
4. Lift up and away from bottom spring clips.
5. Remove filter from front panel by removing elastic band which holds it in place.
6. Clean filter by using a vacuum cleaner or, if very dirty, wash filter with warm water and a mild detergent. Air dry thoroughly before replacing. **Do not use a hot air dryer on filter.**
7. Clean front panel using a soft cloth with warm water and a mild detergent. Rinse and dry.
8. Replace filter and hold it in place with elastic band.
9. Wipe control panel clean with a soft dry cloth.
10. Replace front panel. Locate bottom of panel on the spring clips. Press down on top edge of front panel and push front toward unit to secure upper tabs.
11. Reconnect power supply.

# Caring For Your Air Conditioner

## Annual maintenance

Your air conditioner needs annual maintenance to help ensure steady, top performance throughout the year.

Call the service company recommended by your dealer to:

- Inspect and clean the coils and condensate water passages.
- Check fan and oil the fan motor.

The compressor is sealed and needs no oiling. Expense of annual inspection is the customer's responsibility.

OR

If you are familiar with electrical appliances, you can do the inspection and maintenance yourself. If you choose to do so, follow these steps:

### **⚠ WARNING**

#### **Electrical Shock, Product Damage and Personal Injury Hazard**

- Unplug power cord from receptacle before performing any maintenance. Be sure no liquid gets into the motor, electrical control box or compressor electrical terminals.
- Do not lift, push or pull any white beaded foam (expanded polystyrene) parts.
- Because your air conditioner weighs from 80 to 110 pounds, it is recommended that you have someone help you when you remove and re-install your unit and that you both use proper lifting techniques.
- Handle the air conditioner with care. Watch out for the sharp metal fins on the front and rear condenser coils.
- Do not use the collected water for drinking purposes. It is not sanitary.

Failure to follow the above precautions could result in electrical shock, product damage or personal injury.

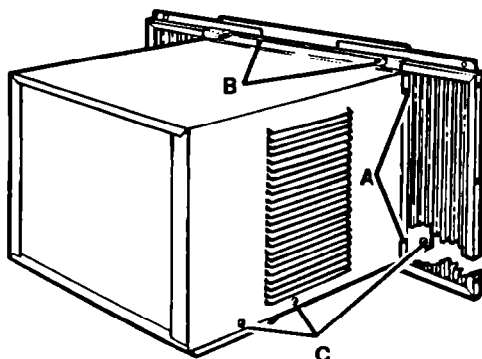

1. Unplug power cord.
  2. Remove the front panel. (See "Cleaning front panel and filter" on page 5.)
  3. Remove unit from window.
  4. Remove side curtains. Slide curtains out to fullest width. From the back side, remove the phillips-head screws which attach the curtains to the cabinet. (See A in illustration at left.)
  5. Remove slotted, hex-head screws holding top channel. (See B in illustration at left.)
  6. Remove slotted, hex-head screws on sides of cabinet. (See C in illustration at left.)
  7. Holding the cabinet on both sides, carefully lift cabinet off unit base.
  8. Wrap the motor, electrical control box and compressor terminal box in plastic film to make sure no water or other liquid gets inside. Water or other liquids could damage insulation and cause serious mechanical problems.
  9. Clean and hose out the base, coils and condensate pans. Clean at least once a year, or more often if the condenser coils and pans collect dirt, sand, leaves, insects or algae. Also, clean if you detect an odor coming from the air conditioner.
- NOTE:** A good time to oil the fan motor is when you already have the cabinet open. See "Oiling the fan motor" on page 8.
10. Remove plastic film from motor and electrical parts.
  11. Replace unit in cabinet. Reattach top channel and side curtains.
  12. Reinstall unit in window.
  13. Replace front panel.
  14. Plug in power cord.

**NOTE:** It is a good idea to wait 24 hours before starting the unit again. This allows time for all areas to dry thoroughly. The water from rainfall or from normal operation does not harm these components.

## Oiling the fan motor

### **⚠ WARNING**

**Electrical Shock Hazard**  
Unplug power cord from receptacle before oiling fan motor. Failure to do so could result in electrical shock.

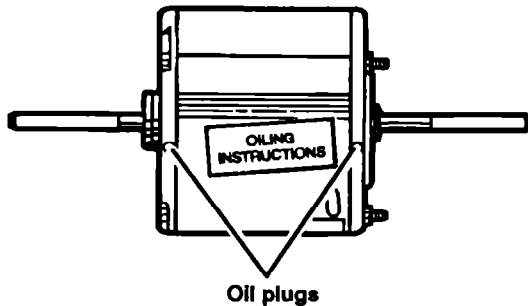

1. Unplug power cord.
2. Remove unit from cabinet. (See steps 1-7 in "Annual maintenance" on page 7.)
3. Oil the fan motor according to instructions on the motor. To add oil, remove the oil hole plug at each end of the motor. An easy-to-use capsule of especially recommended oil (Part No. 10943) is available through your nearest authorized Whirlpool service company, or use SAE #20 non-detergent oil.
4. Replace the plugs to keep dirt from motor bearings.
5. Replace unit in cabinet.
6. Plug in power cord.

## Energy saving tips

- Improve home insulation. Seal doors and windows. Close fireplace flue.
- Close blinds or drapes on sunny side of house. Add window awnings.
- Keep air filter clean.
- Do not block air flow with drapes or furniture.
- Ventilate attic. High temperatures in the attic add to the cooling load.
- Try not to use heat-producing appliances during the hottest part of the day.
- Turn lights and appliances off when not needed.
- Keep heat registers and cool-air returns closed.
- Use exhaust venting fans while cooking, doing laundry and bathing.



# If You Need Service Or Assistance

We suggest you follow these steps:

## 1. Before calling for assistance ...

Performance problems often result from little things you can find and fix yourself without tools of any kind.

### Air conditioner won't run:

- Is unit plugged into a live circuit with proper voltage?
- Is switch turned on?
- Is Thermostat Control set correctly?
- Have you checked your home's main fuses or circuit breaker box?
- Has the time-delay fuse blown or circuit breaker tripped?
- Has the local power failed?

### Unit blows fuses or trips circuit breaker:

- Are time-delay fuses being used?
- Is an extension cord being used? (**Do not use an extension cord to run your air conditioner.**)
- Are you waiting 3 minutes after turning cooling circuit off before trying to restart unit?

### Unit turns on and off, or does not cool room:

- Is filter clean?
- Are coils clean (both evaporator [inside] and condenser [outside])?
- Is there excessive moisture or heat (open vessel cooking, showers, etc.)?
- Try setting fan to higher speed.
- Try setting Thermostat Control to a cooler setting.

### Operating sounds:

When your room air conditioner is **operating normally**, you will hear sounds such as:

- Droplets of water hitting the condenser, causing a "pinging" or "clicking" sound. Water droplets help to cool the condenser.
- Air movement from the fan, especially on high fan speed setting.
- Clicks from the cooling cycle.

Sounds also may be caused by house construction—such as vibration of the unit due to wall construction or unsteady window mounting area.

## 2. If you need assistance\*...

Call Whirlpool Consumer Assistance Center telephone number. Dial free from anywhere in the U.S.:

1-800-253-1301

and talk with one of our trained consultants. The consultant can instruct you in how to obtain satisfactory operation from your appliance or, if service is necessary, recommend a qualified service company in your area.

If you prefer, write to:

Mr. Donald Skinner  
Director of Consumer Relations  
Whirlpool Corporation  
2000 M-63  
Benton Harbor, MI 49022

Please include a daytime phone number in your correspondence.

## 3. If you need service\*...



Whirlpool has a nationwide network of authorized Whirlpool<sup>SM</sup> service companies. Whirlpool service technicians are trained to

fulfill the product warranty and provide after-warranty service, anywhere in the United States. To locate the authorized Whirlpool service company in your area, call our Consumer Assistance Center telephone number (see Step 2) or look in your telephone directory Yellow Pages under:

APPLIANCES - HOUSEHOLD - MAJOR - SERVICE & REPAIR      ELECTRICAL APPLIANCES - MAJOR - REPAIRING & PARTS  
OR  
WASHING MACHINES, DRYERS & IRONERS - SERVICING  
WHIRLPOOL APPLIANCES AUTHORIZED WHIRLPOOL SERVICE  
SERVICE COMPANIES  
XYZ SERVICE CO  
123 Maple.....000-0000

**If You Need Service Or Assistance  
Continued**

**4. If you need FSP® replacement parts\*...**

FSP is a registered trademark of Whirlpool Corporation for quality parts. Look for this symbol whenever you need a replacement part for your Whirlpool appliance. FSP replacement parts will fit right and work right, because they are made to the same exacting specifications used to build every new Whirlpool appliance.

To locate FSP replacement parts in your area, refer to Step 3 above or call the Whirlpool Consumer Assistance Center number in Step 2.

**5. If you are not satisfied with how the problem was solved\* ...**

- Contact the Major Appliance Consumer Action Panel (MACAP). MACAP is a group of independent consumer experts that voices consumer views at the highest levels of the major appliance industry.
- Contact MACAP only when the dealer, authorized servicer and Whirlpool have failed to resolve your problem.
  - Major Appliance Consumer Action Panel
  - 20 North Wacker Drive
  - Chicago, IL 60606
- MACAP will in turn inform us of your action.

\*When requesting assistance, please provide: model number, serial number, date of purchase, and a complete description of the problem. This information is needed in order to better respond to your request.



# WHIRLPOOL® Room Air Conditioner Warranty

AC003

LENGTH OF WARRANTY	WHIRLPOOL WILL PAY FOR
<b>FULL ONE-YEAR WARRANTY</b> From Date of Purchase	FSP* replacement parts and repair labor to correct defects in materials or workmanship.
<b>FULL FIVE-YEAR WARRANTY</b> From Date of Purchase	FSP replacement parts and repair labor to correct defects in materials or workmanship in the sealed refrigeration system. These parts are: <div style="display: flex; flex-wrap: wrap; padding-left: 20px;"> <div style="width: 50%;">1. Compressor</div> <div style="width: 50%;">4. Drier-Strainer</div> <div style="width: 50%;">2. Evaporator</div> <div style="width: 50%;">5. Connecting Tubing</div> <div style="width: 50%;">3. Condenser</div> </div>
<b>WHIRLPOOL WILL NOT PAY FOR</b>	
<p><b>A. Service calls to:</b></p> <ol style="list-style-type: none"> <li>1. Correct the installation of the air conditioner.</li> <li>2. Instruct you how to use the air conditioner.</li> <li>3. Replace house fuses or correct house wiring.</li> <li>4. Clean or replace air filter.</li> </ol> <p><b>B. Pickup and delivery.</b> This product is designed to be repaired in the home.</p> <p><b>C. Damage to the air conditioner caused by accident, misuse, fire, flood, acts of God or use of products not approved by Whirlpool.</b></p> <p><b>D. The removal and reinstallation of the air conditioner if it is installed in an overhead or other inaccessible location or not installed in accordance with published installation instructions.</b></p> <p><b>E. Repairs to parts or systems caused by unauthorized modifications made to the appliance.</b></p>	

Service under the full warranties must be provided by an authorized Whirlpool<sup>SM</sup> service company.

WHIRLPOOL CORPORATION SHALL NOT BE LIABLE FOR INCIDENTAL OR CONSEQUENTIAL DAMAGES. Some states do not allow the exclusion or limitation of incidental or consequential damages so this limitation may not apply to you. This warranty gives you specific legal rights, and you may also have other rights which vary from state to state.

Outside the United States, a different warranty may apply. For details, please contact your authorized Whirlpool distributor or military exchange.

If you need service, first see the "Service and Assistance" section of this book. After checking "Service and Assistance," additional help can be found by calling our Consumer Assistance Center telephone number, 1-800-253-1301, from anywhere in the U.S.

® Registered Trademark / SM Service Mark of Whirlpool Corporation

Part No. 1158930 Rev. A  
© 1991 Whirlpool Corporation

Printed in U.S.A.

## Free Manuals Download Website

<http://myh66.com>

<http://usermanuals.us>

<http://www.somanuals.com>

<http://www.4manuals.cc>

<http://www.manual-lib.com>

<http://www.404manual.com>

<http://www.luxmanual.com>

<http://aubethermostatmanual.com>

Golf course search by state

<http://golfingnear.com>

Email search by domain

<http://emailbydomain.com>

Auto manuals search

<http://auto.somanuals.com>

TV manuals search

<http://tv.somanuals.com>