

Models **3LE5700XK**
3LG5701XK



Whirlpool DRYER

Use & Care

Guide

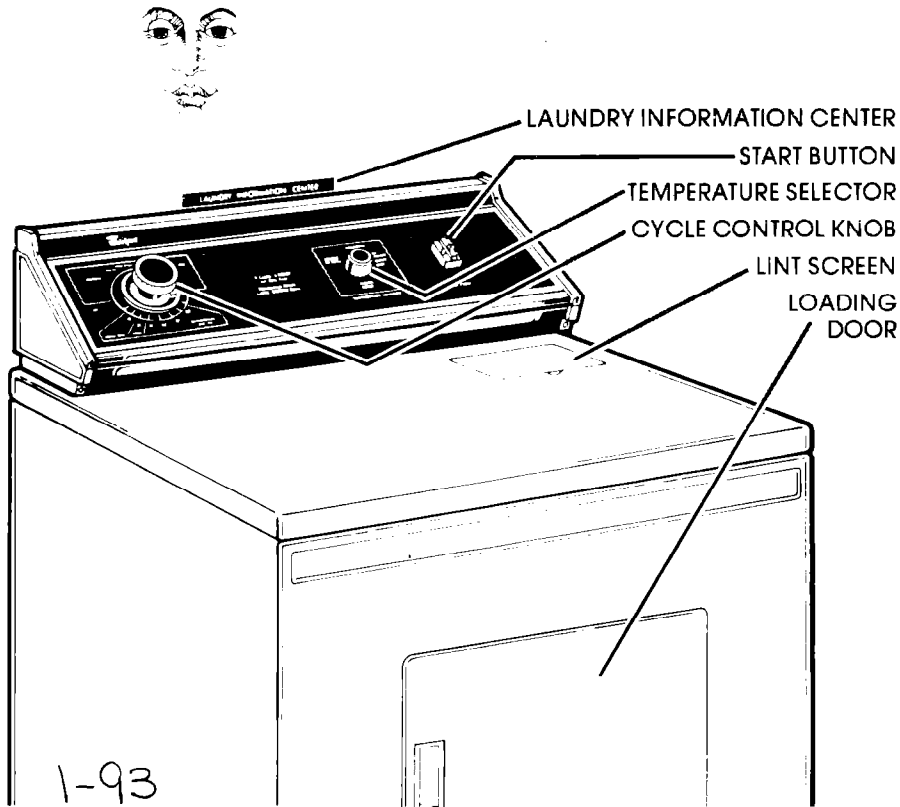

Copy your Model and Serial Numbers here

If you ever need to call for service, you will need to give the Model and Serial Numbers. Your dryer has these numbers on a plate behind the door.

Copy the numbers in these spaces. Keep this book in the Laundry Information Center with your *Dryer Guide*, sales slip and warranty.

Model No _____

Serial No _____

Purchase/Installation Date _____

Before using your Dryer

Please read this booklet to be sure your dryer is installed and used properly. It will help you get the best results and longest life your dryer was designed to give.

You are personally responsible for making sure that your dryer...

- Is installed by a qualified installer.
- Is properly installed and leveled in a well ventilated room* on a floor that can support the weight.
- Is connected to the right kind of outlet, electric supply and grounding*.
- Is properly connected to fuel and exhaust systems*.
- Is used only for jobs normally expected of home clothes dryers.
- Is properly maintained.
- Is installed in an area protected from the weather.
- Is not run where there may be explosive fumes.
- Is not used by children or anyone unable to operate it properly.

Remove the Consumer Buy Guide label before using your dryer. It will be easier to remove.

Wipe out the drum with a damp cloth to remove any dust.

SPECIAL INSTRUCTIONS: See the Dryer Guide for drying tips, information about permanent press and knits, instructions for drying special items and for things not to be dried in your dryer.

*See the Installation Instructions for complete information.

FOR YOUR SAFETY

If you smell gas:

1. Open windows
2. Don't touch electrical switches
3. Extinguish any open flame
4. Immediately call your gas supplier.

SAFETY FIRST:

To prevent serious injury, **DO NOT** allow children to operate, play with, or crawl inside the dryer.

FOR YOUR SAFETY

Do not store or use gasoline or other flammable vapors and liquids in the vicinity of this or any other appliance.

SAFETY

Never operate your dryer without replacing all panels (lower front, access or service).

Please read this manual. Follow the instructions to help you get the best drying results. Save the manual for future use.

Contents

Before Using Your Dryer	2
Loading Your Dryer	3
Understanding Your Dryer	3
Lint Screen	3
Using Your Dryer	4
Selecting Cycles and Temperature Settings	5
Setting Drying Times	6
FLUFF AIR	6
TUMBLE PRESS® Control	6
If You Need Service or Help	
Before Calling for Service	7
If You Have a Problem	7

Loading your Dryer



For best drying results and energy savings, sort dryer loads carefully.

Separate loads according to the type of fabric and weight. For example:

- Dry heavy fabrics (denims, towels, cottons) separately from light fabrics (permanent press, synthetics).
- Separate lint givers (towels, sweat-shirts, etc.) from lint takers (synthetics, blends, permanent press).
- Keep dark colors and light colors separate.
- Keep colorfast items away from non-colorfast fabrics.

Allow room for items to tumble freely. The load will dry faster with fewer wrinkles.

When drying permanent press, **dry smaller-than-normal** loads for the best wrinkle removal.

Use a mesh bag to hold small items such as baby socks.

Read the Dryer Guide for more hints on sorting and loading.

Understanding your Dryer

Your dryer has five cycles. The EXTRA HEAVY, HEAVY, MEDIUM and LIGHT Cycles are designed to tumble laundry for a certain length of time...depending on the load. You select the drying temperature you want.

In all these cycles, the heat shuts off 5 minutes before the dryer stops tumbling. This helps cool down the load.

The cool-down time is built in so the laundry will not be too hot when the dryer stops tumbling.

1. When a load of hot laundry is not tumbling, wrinkles can set in.
2. A load of hot laundry can be too hot to handle comfortably.

The other cycle is PERMANENT PRESS. This cycle has a longer cool-down time at the end. This extra time is designed to give permanent press fabrics the extra wrinkle protection they need.

This *Use & Care Guide* contains suggestions on the way to use your dryer to get the best results and longest useful life from your dryer. Please read it carefully.

Lint Screen

The lint screen is under the lid on top of the dryer.

Clean the lint screen before each load. A screen that's blocked by lint can cause longer drying times.

CAUTION: Do not operate the dryer with the lint screen removed or not securely in place as it may cause overheating, possible damage to fabrics and dryer parts or create a fire hazard.

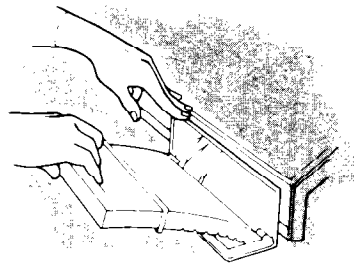

To remove the screen, open the lid and pull the screen straight out. Roll the lint off the screen with your fingers. **DO NOT rinse the screen or wash it.** Wet lint is hard to remove.

When replacing the screen, push it firmly into place. Close the lid.

Using your Dryer

1. Put the sorted load in the dryer and close the door tightly.
2. Turn the Cycle Control Knob to the cycle you want.
 - Use LIGHT for small loads of light-weight fabrics. The LIGHT Cycle runs for the least time. Use LIGHT also to damp dry loads for ironing.
 - Use MED for normal size loads of light or medium weight fabrics (sheets, pillowcases, shirts, etc.).
 - Use HEAVY for normal size loads of heavy fabrics (towels, jeans, corduroys)
 - Use EX HEAVY for large loads or for heavy bulky items (quilts, spreads, blankets, etc.).

SUGGESTION:

You can set the Cycle Control Knob anywhere past, between or below the EX HEAVY and LIGHT settings. For the first few loads:

- Set the pointer in the middle of the load setting.
- If the load is drier than you want, set it to the right (for less time) the next time.
- If the load is not as dry as you want, set it to the left (for more time) the next time.

For example:

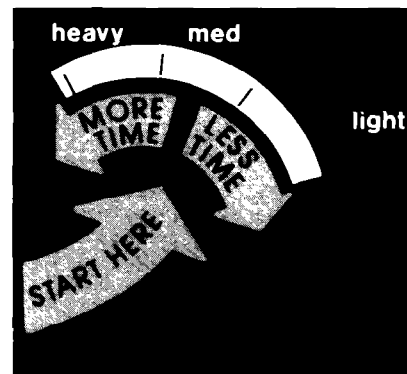

BE CAREFUL NOT TO OVERDRY.
Overdrying can cause shrinkage, static cling and damage to some fabrics.

Whirlpool

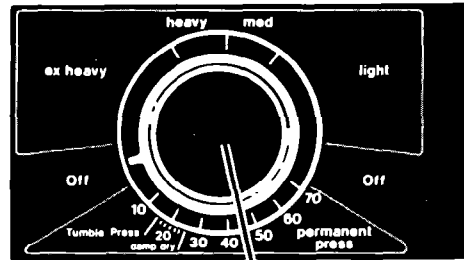

- Use PERMANENT PRESS for a longer period of cool-down time. Set the pointer for the number of minutes of drying time you want. (See Setting Drying Times on page 6.)
- If laundry is left in the dryer after it has stopped tumbling, use the Tumble Press Control setting (page 6) to help remove the wrinkles.

3. Set TEMPERATURE SELECTOR.

- Turn the TEMPERATURE SELECTOR to the drying temperature needed for the load. See page 5 for suggested settings.

4. Push the Start Button.

- Make sure the door is closed and Cycle Control is set. If the door is opened during the cycle, the dryer will stop. **To restart the dryer**, close the door and push the Start Button.

5. To stop the dryer:

- Open the door.
- Or, turn the Cycle Control Knob to one of the OFF positions.
- **To change the setting while the dryer is running**, turn the Cycle Control Knob, either way, so it points to the setting you want.

NOTE: The Cycle Control Knob should point to OFF when the dryer is not being used.

IMPORTANT: To help reduce wrinkling, take the load from the dryer as soon as tumbling stops. This is very important for permanent press, knits and other synthetic fabrics.

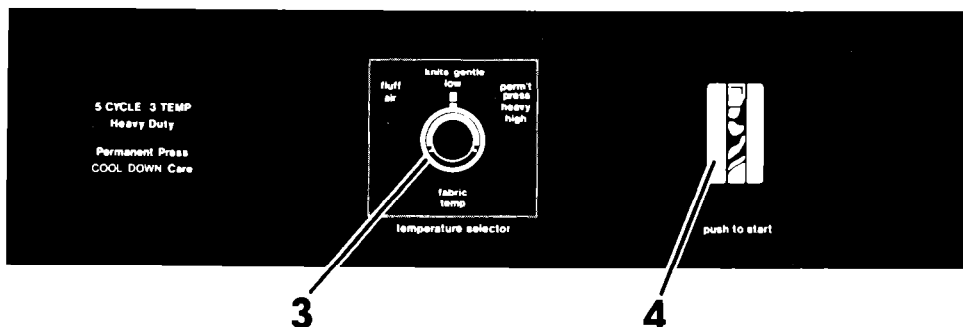

SELECTING CYCLES AND TEMPERATURE SETTINGS

Choose the correct settings according to the chart below:

<u>TYPE OF LOAD</u>	<u>CYCLE</u>	<u>TEMPERATURE SELECTOR</u>
COTTONS – LINENS		
<i>EXTRA HEAVY</i> very large loads – Bedspreads, mattress pads, quilts	EX HEAVY	PERMIT PRESS- HEAVY HIGH
<i>HEAVY FABRICS</i> – Towels, jeans, corduroys, work clothes	HEAVY	PERMIT PRESS- HEAVY HIGH
<i>MEDIUMWEIGHT COTTONS</i> – Sheets, pillowcases, cotton underwear, diapers	MEDIUM	PERMIT PRESS- HEAVY HIGH
<i>LIGHTWEIGHT COTTONS</i> or damp dry – Batistes, organdies, lingerie	LIGHT	PERMIT PRESS- HEAVY HIGH
PERMANENT PRESS – SYNTHETIC FIBERS AND BLENDS		
<i>HEAVYWEIGHT FABRICS</i> – Work clothes, jackets, raincoats, etc.	PERMANENT PRESS 40-50 MIN.	PERMIT PRESS- HEAVY HIGH
<i>MEDIUMWEIGHT FABRICS</i> – Shirts, play clothes, sheets, slacks	30-40 MIN.	PERMIT PRESS- HEAVY HIGH
<i>LIGHTWEIGHT FABRICS</i> – Lingerie, blouses, dresses, etc.	20-30 MIN.	PERMIT PRESS- HEAVY HIGH
KNITS		
<i>HEAVYWEIGHT</i> – COTTONS, RAYONS, BLENDS – T-shirts, slacks, shirts, etc.	PERMANENT PRESS 40-50 MIN.	PERMIT PRESS- HEAVY HIGH
<i>LIGHTWEIGHT</i> – SYNTHETIC FABRICS (polyester, acrylic, etc.) and Blends – Lingerie, blouses, dresses, etc.	30-40 MIN.	KNITS GENTLE-LOW
<i>DELICATELY CONSTRUCTED FABRICS</i> – Curtains (2 or 3 panels.) Sheers	20-30 MIN.	KNITS GENTLE-LOW
FOAM RUBBER ARTICLES – Pillows, bras, etc.	PERMANENT PRESS 20-30 MIN.	FLUFF-AIR

To Damp Dry clothes for ironing, set control in LIGHT setting or PERMANENT PRESS cycle for 20 minutes.

MIXED LOADS

If you dry a mixed load of various weights of fabrics, select the cycle for the lighter weight fabric. When dryer stops, remove the dry articles and reset the control.

Setting Drying Times

Modern dryers are designed with drying temperatures needed to safely handle modern fabrics. Cool-down times have been added to heat settings. You might notice slightly longer drying times.

The time it takes to dry a load depends on:

- *The kind of fabric, its weight, and the size of the load.* A large load of jeans will take a lot longer to dry than a small load of light synthetics.
- *The amount of moisture in the load.* Towels hold a lot of moisture; synthetics don't. Synthetics dry faster.
- *Temperature of the rinse water.* Cold rinses help save on energy and wrinkles, but a cold load will take slightly longer to dry than a warm one.
- *Amount of lint on the screen.* A full lint screen slows the air flow and can make drying time longer.
- *Temperature around the dryer.* The dryer heats room air. If that air is cold, drying time will be longer and fabric wrinkles may not be removed.
- *Proper installation and exhaust systems.* For the fastest possible drying time, installing and exhausting your dryer properly is important. See installation instructions.

Be careful not to overdry. Overdrying can cause shrinkage, damage to some fabrics and static cling.

FLUFF AIR

This temperature setting is useful for fluffing bedding, pillows and clothing, or dusting drapes. It is also best to use when damp-drying heat-sensitive items.

Drying plastic or rubber items with heat may damage the items or be a fire hazard.

FLUFF AIR should be used for such items as plastic shower curtains or tablecloths, rubber-backed rugs, some pillows, stuffed toys, etc.

- Turn the **TEMPERATURE SELECTOR** to **FLUFF AIR**.
- Turn the Cycle Control Knob to the number of minutes you want in the **PERMANENT PRESS** Cycle.
- Push the Start Button.

TUMBLE PRESS[®] Control

This setting is useful for removing wrinkles from packing in suitcases or closets. TUMBLE PRESS will help put them back into their pre-set shape.

- Set Cycle Control Knob to **TUMBLE PRESS**.

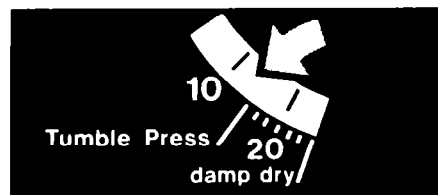

- Set **TEMPERATURE SELECTOR** to **PERM'T PRESS/HEAVY HIGH**.
- Push the Start Button.

For best results, TUMBLE PRESS only a few items at a time; put them on hangers or fold them as soon as the dryer stops.



If You Need Service or Help, We suggest You Follow These Three Steps:

Before calling for service ...

Problems are sometimes caused by little things you can correct without tools. Check this list before you call for service.

DRYER DOES NOT RUN

- Is electric power cord plugged in?

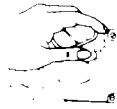

- Is the dryer door closed tightly? Your dryer has a switch by the door that shuts off the dryer if the door is opened.



- Did you push the Start Button?
- Check circuit breakers or fuses in the fuse box.

DRYER RUNS BUT DOES NOT HEAT:

- Is the Cycle Control Knob pointing to at least 10 minutes or LIGHT? (The last minutes are cool-down time.)
- Is it a gas dryer? See if the gas is turned on. If not, turn the Cycle Control Knob to OFF. Turn on the gas and wait five minutes for the automatic switch to reset. Then try starting it again.
- Is it an electric dryer? Check the circuit breakers or fuses in the fuse box. An electric dryer will have two fuses. If one is blown, the dryer may run, but not heat.

DRYING TIME IS LONGER THAN USUAL:

- Check the lint screen. Remove lint. Keep the screen clean for best drying results and times.
- Modern dryers are designed to dry at the cooler temperatures needed by modern fabrics. They may need more time than you are used to.

If you move... To make sure that your appliance is correctly installed and to insure its continued satisfactory operation, call your dealer (Installation cost will, of course, be paid by you.)

Helpful hints... You can help your service representative give you faster service if you include the model and serial number of your appliance when requesting service. Also, retain your sales slip and warranty to verify your warranty status.

Remember... Your service representative is trained in the repairing and servicing of your WHIRLPOOL appliances. He can help you maintain the quality originally built into your WHIRLPOOL appliance. So why not take the time, now, to look up his telephone number and jot it down in the space provided on the cover.

If you have a problem*:

Call your dealer or write:
Service Manager, International
Division
Whirlpool Corporation
Administrative Center
2000 U.S. 33 North
Benton Harbor, Michigan 49022

*If you must write, please provide: your name, address, telephone number, type of appliance, brand, model, serial number, date of purchase, the dealer's name, and a complete description of the problem. This information is needed in order to better respond to your request for assistance.



FSP is a registered trademark of Whirlpool Corporation for quality parts. Look for this symbol of quality whenever you need a replacement part for your Whirlpool appliance.

FSP replacement parts will fit right and work right, because they are made to the same exacting specifications used to build every new Whirlpool appliance.



Whirlpool
Home Appliances



Quality. Our way of life.

Benton Harbor, Michigan. Automatic Washers, Clothes Dryers, Freezers, Refrigerator-Freezers, Ice Makers, Dishwashers, Built-in Ovens and Surface Units, Ranges, Microwave Ovens, Compactors, Room Air Conditioners, Dehumidifiers, Central Heating and Air Conditioning Systems.

Free Manuals Download Website

<http://myh66.com>

<http://usermanuals.us>

<http://www.somanuals.com>

<http://www.4manuals.cc>

<http://www.manual-lib.com>

<http://www.404manual.com>

<http://www.luxmanual.com>

<http://aubethermostatmanual.com>

Golf course search by state

<http://golfingnear.com>

Email search by domain

<http://emailbydomain.com>

Auto manuals search

<http://auto.somanuals.com>

TV manuals search

<http://tv.somanuals.com>