



ELECTRIC DRYER

Use & Care Guide

Table of Contents 2

**FOR MODELS: 3RLEC8600
3RLEQ8033
3RLEQ8600**

W10131582C

TABLE OF CONTENTS

DRYER SAFETY	2	Drying Rack (optional)	8
DRYER DISPOSAL	4	DRYER CARE	9
PARTS AND FEATURES	5	Cleaning the Dryer Location.....	9
CHECKING YOUR VENT	6	Cleaning the Lint Screen	9
DRYER USE	6	Cleaning the Dryer Interior	9
Starting Your Dryer	6	Removing Accumulated Lint.....	9
Stopping and Restarting.....	7	Vacation and Moving Care.....	10
Drying, Cycle, and Temperature Tips	7	TROUBLESHOOTING	10
Cycle Descriptions	7	ASSISTANCE OR SERVICE	12
Additional Features	8		

DRYER SAFETY

Your safety and the safety of others are very important.

We have provided many important safety messages in this manual and on your appliance. Always read and obey all safety messages.



This is the safety alert symbol.

This symbol alerts you to potential hazards that can kill or hurt you and others.

All safety messages will follow the safety alert symbol and either the word “DANGER” or “WARNING.”

These words mean:

⚠ DANGER

You can be killed or seriously injured if you don't immediately follow instructions.

⚠ WARNING

You can be killed or seriously injured if you don't follow instructions.

All safety messages will tell you what the potential hazard is, tell you how to reduce the chance of injury, and tell you what can happen if the instructions are not followed.



WARNING - “Risk of Fire”

- Clothes dryer installation must be performed by a qualified installer.
- Install the clothes dryer according to the manufacturer's instructions and local codes.
- Do not install a clothes dryer with flexible plastic venting materials. If flexible metal (foil type) duct is installed, it must be of a specific type identified by the appliance manufacturer as suitable for use with clothes dryers. Flexible venting materials are known to collapse, be easily crushed, and trap lint. These conditions will obstruct clothes dryer airflow and increase the risk of fire.
- To reduce the risk of severe injury or death, follow all installation instructions.
- Save these instructions.

IMPORTANT SAFETY INSTRUCTIONS

WARNING: To reduce the risk of fire, electric shock, or injury to persons when using the dryer, follow basic precautions, including the following:

- Read all instructions before using the dryer. 
- Keep a minimum clearance of 102 mm (4 in.) between the rear of the dryer and any wall.
- The operation of this appliance may affect the operation of other types of appliances which take their air supply for safe combustion from the same room. There has to be adequate ventilation to replace exhausted air and thus avoid the back-flow of gasses into the room from appliances burning other fuels, including open fires, when operating the tumble dryer. If in doubt, consult the appliance manufacturers.
- Do not obstruct the air supply to the dryer (see Installation Instructions for minimum clearances).
- Do not place items exposed to cooking oils in your dryer. Oil-affected items can ignite spontaneously, especially when exposed to heat sources such as in a tumble dryer. The items become warm causing an oxidation reaction in the oil. Oxidation creates heat. If the heat cannot escape, the items can become hot enough to catch fire. Piling, stacking or storing oil-affected items can prevent heat from escaping and so create a fire hazard.
- If it is unavoidable to dry in the dryer items that have been soiled with substances such as cooking oil, acetone, alcohol, petrol, kerosene, spot removers, turpentine, waxes and wax removers, or that have been contaminated by hair care products, should be washed in hot water with an extra amount of detergent before being dried in the dryer. These items may give off vapours that could ignite or explode. Such washing will reduce, but not eliminate, the hazard.
- This appliance is not intended for use by persons (including children) with reduced physical, sensory or mental capabilities, or lack of experience and knowledge, unless they have been given supervision or instructions concerning use of the appliance by persons responsible for their safety.
- Children should be supervised to ensure that they do not play with the appliance.
- The dryer should not be used if industrial chemicals have been used for cleaning.
- Before the dryer is removed from service or discarded, remove the doors to the drying compartment.
- Do not reach into the dryer if the drum is moving. A door switch is fitted for your safety.
- Do not install or store the dryer where it will be exposed to the weather.
- Do not tamper with controls.
- Do not continue to use this appliance if it appears to be faulty.
- Do not repair or replace any part of the dryer or attempt any maintenance unless specifically recommended in this Use and Care Guide. Repairs and servicing should only be carried out by competent service personnel.
- Do not use fabric softeners or products to eliminate static unless recommended by the manufacturer of the fabric softener or product. Follow their instructions.
- Clean dryer lint screen before or after each load. Do not operate dryer without lint screen in place.
- Keep area around the exhaust and inlet openings and adjacent surrounding areas free from the accumulation of lint, dust, and dirt.
- The interior of the dryer and exhaust vent should be cleaned periodically by qualified service personnel.
- See Installation Instructions for earthing instructions.
- Do not dry unwashed items in this dryer.
- Items such as foam rubber (latex foam), shower caps, waterproof textiles, rubber backed articles and clothes or pillows fitted with foam rubber pads should only be dried on a clothesline.
- The final part of a tumble dryer cycle occurs without heat (cool down cycle) to ensure that the items are left at a temperature that ensures the items will not be damaged.

WARNING: Never stop a tumble dryer cycle before the end of the drying cycle unless all items are quickly removed and spread out so that the heat is dissipated.

SAVE THESE INSTRUCTIONS

FOR YOUR SAFETY

1. Do not use or store petrol or other flammable materials in this appliance or near this appliance.
2. Do not spray aerosols in the vicinity of this appliance while it is in operation.
3. Do not modify this appliance.

DRYER DISPOSAL



This appliance is marked according to the European directive 2002/ 96/ EC on Waste Electrical and Electronic Equipment (WEEE).

By ensuring this product is disposed of correctly, you will help avoid potential negative consequences for the environment and human health, which could otherwise be caused by inappropriate waste handling of this product.

The symbol on the product, or on the documents accompanying the product, indicates that this appliance may not be treated as household waste. Instead it shall be handed over to the applicable collection point for the recycling of electrical and electronic equipment.

Disposal must be carried out in accordance with local environmental regulations for waste disposal.

For more detailed information about treatment, recovery and recycling of this product, please contact your local city office, your household waste disposal service or the shop where you purchased the product.

PARTS AND FEATURES

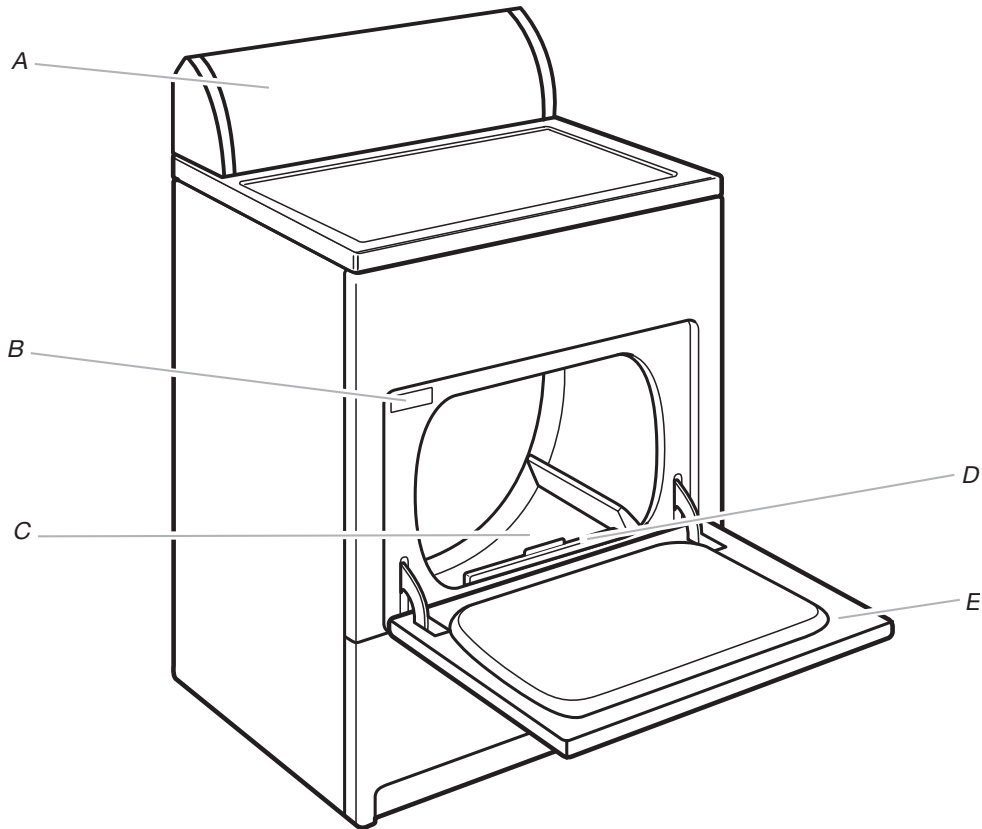

- A. Control panel
- B. Model and serial number label
- C. Dryer drum
- D. Lint screen
- E. Wide-opening door

Additional features your dryer may have
 Super wide-swing reversible door



End of Cycle Signal selector
 Wrinkle Guard selector
 Automatic Dry sensor

Optional purchase
 Drying rack

Control Panel (example)

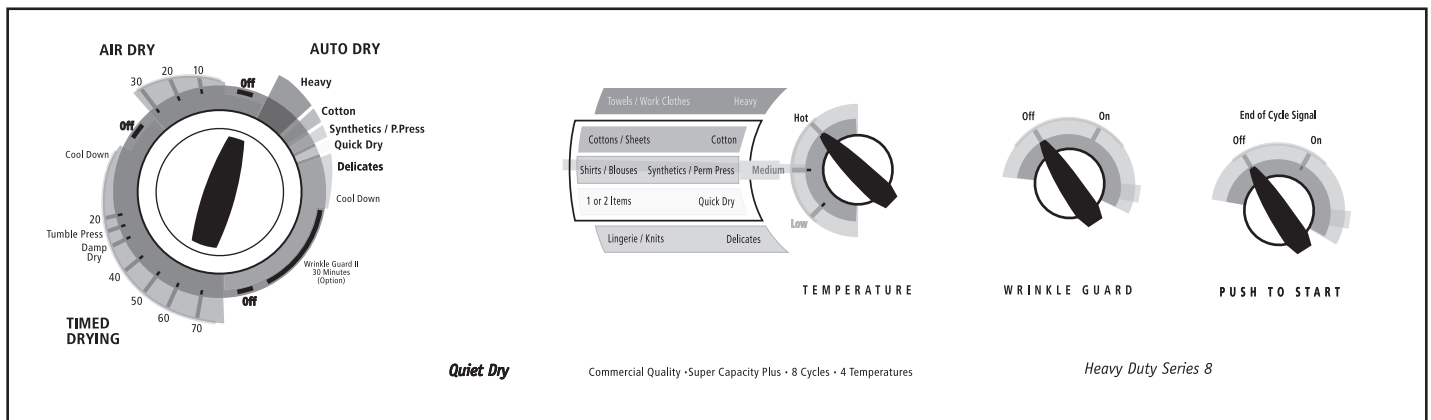

CHECKING YOUR VENT

Your dryer must be properly installed and vented to achieve maximum drying efficiency and shorten drying times. Use the minimum recommended installation clearances found in the Installation Instructions. Refer to the Installation Instructions for more information.

⚠ WARNING



Fire Hazard

- Use a heavy metal vent.
- Do not use a plastic vent.
- Do not use a metal foil vent.
- Failure to follow these instructions can result in death or fire.

If the dryer is not properly installed and vented, it will not be covered under the warranty. Proper venting of your dryer is important for satisfactory drying results. See the Installation Instructions for more detail.

IMPORTANT: The dryer exhaust must not be connected into any gas vent, chimney, wall, ceiling, attic, crawlspace, or a concealed space of a building.

NOTE: Service calls caused by improper venting will be paid for by the customer, whether it was a paid installation or self-installed.

1. Do not use plastic vent or metal foil vent. Use 102 mm (4") metal or flexible metal vent. Do not kink or crush flexible metal vent. It must be completely extended to allow adequate exhaust air to flow. Check vent after installation. Refer to the Installation Instructions for proper length requirements of vent.

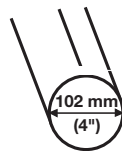

2. Use a 102 mm (4") exhaust hood.
3. Use the straightest path possible when routing the vent.

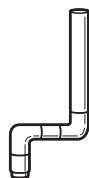

Good



Better

4. Exhaust vent must not be connected or secured with screws or other fastening devices that extend into the interior of the duct and catch lint. Do not use duct tape.
5. Clean exhaust vent periodically, depending on use, but at least every 2 years, or when installing your dryer in a new location. When cleaning is complete, be sure to follow the Installation Instructions supplied with your dryer for final product check.

DRYER USE

Starting Your Dryer

⚠ WARNING



Explosion Hazard

- Keep flammable materials and vapors, such as petrol, away from dryer.
- Do not dry anything that has ever had anything flammable on it (even after washing).
- Failure to follow these instructions can result in death, explosion, or fire.

⚠ WARNING



Fire Hazard

- No washer can completely remove oil.
- Do not dry anything that has ever had any type of oil on it (including cooking oils).
- Items containing foam, rubber, or plastic must be dried on a clothesline.
- Failure to follow these instructions can result in death or fire.

This booklet covers several different models. Your dryer may not have all of the cycles and features described.

Before using your dryer, wipe the dryer drum with a damp cloth to remove dust from storing and shipping.

1. Clean lint screen before each load. See "Cleaning the Lint Screen."
2. Load clothes loosely into the dryer and close the door. Do not pack the dryer. Allow space for clothes to tumble freely. Maximum clothing load (cotton fabrics) is 9.0 kg (19.8 lbs).



3. Turn the Cycle Control knob to the recommended cycle for the type of load being dried. See “Drying, Cycle, and Temperature Tips.”
4. Select a temperature setting on models with a temperature selector. The cycle descriptions include temperature setting suggestions.

NOTE: The temperature selector is part of the Cycle Control knob on some models.
5. Select the End of Cycle Signal, if available. The signal is helpful when drying permanent press or synthetics. Promptly remove these items from the dryer at the end of the cycle to avoid wrinkles.
6. Select Wrinkle Guard, if available.
7. Press PUSH TO START.

NOTE: Your dryer stops automatically when a cycle ends.

How Automatic Drying Works

During the Auto Dry Cycle, the exhaust temperature of the dryer determines the drying time and dryness levels. A thermostat signals the Cycle Control knob when to move into Cool Down. The drying time for an Auto Dry Cycle depends on load type and load size. When drying a large or heavy load, the Cycle Control knob may take a long time before it begins to advance into Cool Down. The Auto Dry Cycle takes the guesswork out of drying time and enhances fabric care. The amount of time that is displayed is the estimated time remaining in the cycle.

Stopping and Restarting

You can stop your dryer anytime during a cycle.

To stop your dryer

Open the dryer door or turn the Cycle Control knob to OFF.

NOTE: The Cycle Control knob should point to an Off area when the dryer is not in use.

To restart your dryer

1. Close the door.
2. Select a new cycle and temperature (if desired).
3. Press the Start button.

Drying, Cycle, and Temperature Tips

Select the correct cycle and temperature for your load.

Cool Down tumbles the load without heat during the last few minutes of all cycles to make the load easier to handle.

Drying tips

- Follow care label directions when they are available.
- If desired, add a fabric softener sheet. Follow package instructions.
- To reduce wrinkling, remove the load from the dryer as soon as tumbling stops. This is especially important for permanent press, knits, and synthetic fabrics.

Cycle and temperature tips

- Use a Hot (or High) Heat setting for drying heavyweight items such as towels and work clothes.
- Use a Medium Heat setting for drying medium-weight items such as sheets, underwear, permanent press fabrics, and some knits.

- Use a Low Heat setting for drying lightweight items such as lingerie, blouses, dresses, and some knits.
- Line dry bonded or laminated fabrics.

NOTE: If you have questions about drying temperatures for various loads, refer to the care label directions. If you are unsure of the temperature to select for a load, select a lower setting rather than a higher setting.

Cycle Descriptions

This manual covers several different models. Your dryer may vary from the model shown, and may not have all of the cycles and features described.

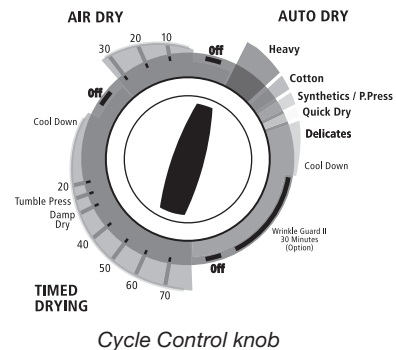

Cycle Control knob

Auto Dry cycle

Use your Automatic cycle to dry most loads. Your dryer has a control that senses the moisture level in the load and shuts off when the load reaches the selected dryness.

- Select the temperature from the temperature selector based on the fabrics in your load.

After drying a load, check the dryness.

- If the load is drier than you like, select a setting closer to Delicates the next time you dry a similar load.
- If a load is not as dry as you like, complete drying using a Timed cycle. Select a setting closer to Heavy the next time you dry a similar load.

NOTE: Drying time varies with an Automatic cycle. The type of fabric, the size of the load, and the dryness selected affect drying time. See “Drying, Cycle, and Temperature Tips.”

Timed Drying cycle(s)

Use Timed Drying for heavyweight and bulky items, such as bedspreads and work clothes or large loads that require a long drying time. Set the temperature selector, if available, to Hot (or High) Heat.

On some models, you may use the Timed Drying cycle for lightweight items such as lingerie or knits. Set the temperature selector, if available, based on the fabrics in your load.

NOTE: Use your Timed Drying cycle to complete drying if items are still damp after the Automatic cycle.

Additional Features

This manual covers several different models. Your dryer may not have all of the features described.

Heavy

Select this setting to evenly dry large or heavy items such as thick cotton bath towels or robes. Set the Temperature selector, if available, to Hot (or High) Heat.

Cotton

Select this setting to thoroughly dry heavy items such as sheets, mattress pads and quilts, or a load of towels. Set the Temperature selector, if available, to Hot (or High) Heat.

Synthetics/Perm Press

Select this cycle to dry medium to lightweight synthetic or no-iron items such as shirts, blouses, or dresses. Choose a Medium Heat setting if available.

Quick Dry

Use this cycle for drying small loads or loads that need a short drying time. Choose a Hot (or High) or Medium Heat setting depending on the type of fabrics being dried.

Delicates

Select this option to dry small loads or lightweight items. Set the Temperature selector, if available, to Low Heat.

TUMBLE PRESS setting

Select this cycle to help remove wrinkles from items such as clothing packed in a suitcase or items wrinkled from being left in the dryer too long. Set the Temperature selector, if available, to Medium or Low Heat depending on the fabrics in your load.

Damp Dry

Select this cycle to dry items to a damp level, or to dry items that do not require an entire drying cycle. Use the Damp Dry cycle on items such as jeans (to avoid stiffness) or cotton clothing (to make pressing easier). If your model has a Temperature selector, choose a temperature setting based on the fabrics in your load.

Wrinkle Guard II™

When you are unable to remove a load from the dryer as soon as it stops, wrinkles can form. The Wrinkle Guard II feature periodically tumbles, rearranges and fluffs the load for up to 30 minutes without heat to help keep wrinkles from forming. Press the Wrinkle Guard ON button to enable the Wrinkle Guard II feature. A signal will sound periodically when the Wrinkle Guard II feature is on if the End of Cycle Signal is selected. The signal and the tumbling will end when you open the dryer door, or when you turn the Cycle Control knob to Off.

End of Cycle Signal

- The End of Cycle signal sounds when a cycle is complete. If your End of Cycle signal is selectable, the signal will sound only if set to On.
- If the Wrinkle Shield feature is on, the signal sounds every few minutes. The signal stops when you open the door or turn the Cycle Control knob to Off.

Drying Rack (optional)

The drying rack is useful for machine drying items you would not necessarily want to tumble dry or that you would normally line dry (for example, sweaters or tennis shoes).

You can order a drying rack by contacting the dealer from whom you purchased your dryer.

To use the drying rack

1. Slide rear pegs into the dimples on the back wall of the dryer. Lower the front legs to rest on the dryer opening.



2. Put the wet items on top of the drying rack. Leave space between the items so air can reach all the surfaces. Close the door.

NOTE: Do not allow items to hang over the edge of the drying rack.

3. Select cycle and temperature to match the fabrics in your load. Items containing foam, rubber or plastic must be dried on a clothesline. Refer to the following table.
4. Press Start. Reset cycle to complete drying, if needed.

NOTE: The drying rack must be removed for normal tumbling. Do not use the automatic cycle with the drying rack.

Rack Dry	Cycle	Temp	Time*
Wool Sweaters Block to shape and lay flat on the drying rack	Timed	Low	60
Stuffed toys or pillows Cotton or polyester fiber filled	Timed	Low	60
Stuffed toys or pillows Foam rubber filled	Can only be dried on a clothesline.		

*(Minutes). Reset cycle to complete drying if needed.

DRYER CARE

Cleaning the Dryer Location

Keep dryer area clear and free from items that would obstruct the flow of combustion and ventilation air.

⚠ WARNING



Explosion Hazard

Keep flammable materials and vapors, such as petrol, away from dryer.

Place dryer at least 460 mm (18 inches) above the floor for a garage installation.

Failure to do so can result in death, explosion, or fire.

Cleaning the Lint Screen

Every load cleaning

The lint screen is located in the door of the dryer. Clean the lint screen before each load. A screen blocked by lint can increase drying time.

To clean

1. Pull the lint screen toward you. Roll lint off the screen with your fingers. Do not rinse or wash screen to remove lint. Wet lint is hard to remove.

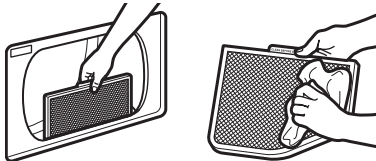

2. Push the lint screen firmly back into place.

IMPORTANT:

- Do not run the dryer with the lint screen loose, damaged, blocked, or missing. Doing so can cause overheating and damage to both the dryer and fabrics.
- If lint falls off the screen into the dryer during removal, check the exhaust hood and remove the lint. See "Checking Your Vent."

As needed cleaning

Laundry detergent and fabric softener residue can build up on the lint screen. This buildup can cause longer drying times for your clothes, or cause the dryer to stop before your load is completely dry. The screen is probably clogged if lint falls off the screen.

Clean the lint screen with a nylon brush every 6 months, or more frequently if it becomes clogged due to a residue buildup.

To wash

1. Roll lint off filter using your fingers.
2. Wet both sides of lint screen with hot water.
3. Wet a nylon brush with hot water and liquid detergent. Scrub lint screen with the brush to remove residue buildup.

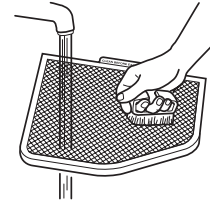

4. Rinse screen with hot water.
5. Thoroughly dry lint screen with a clean towel. Insert lint screen back into dryer.

Cleaning the Dryer Interior

1. Apply a liquid, nonflammable household cleaner to the stained area of the drum and rub with a soft cloth until stain is removed.
2. Wipe drum thoroughly with a damp cloth.
3. Tumble a load of clean cloths or towels to dry the drum.

NOTE: Garments that contain unstable dyes, such as denim blue jeans or brightly colored cotton items, may discolor the dryer interior. These stains are not harmful to your dryer and will not stain future loads of clothes. Dry unstable dye items inside out to avoid transfer of dye.

Removing Accumulated Lint

From Inside the Dryer Cabinet

Lint should be removed every 2 years, or more often, depending on dryer usage. Cleaning should be done by a qualified person.

From Inside the Exhaust Vent

Lint should be removed every 2 years, or more often, depending on dryer usage.

Vacation care

Operate your dryer only when you are at home. If you will be on vacation or not using your dryer for an extended period of time, you should:

1. Disconnect power.
2. Clean lint screen. See "Cleaning the Lint Screen."

Moving care

⚠ WARNING



Electric Shock Hazard

Disconnect power before servicing.

Replace all parts and panels before operating.

Failure to do so can result in death or electric shock.

1. Disconnect power.
2. Disconnect wiring.
3. Make sure leveling legs are secure in dryer base.
4. Use masking tape to secure dryer door.

TROUBLESHOOTING

First try the solutions suggested here and possibly avoid the cost of a service call...

Dryer Operation

Dryer will not run

- **Has a household fuse blown, or has a circuit breaker tripped?**
Check that the fuse is intact and tight, or that the circuit breaker has not tripped. Replace the fuse or reset the circuit breaker. If the problem continues, call an electrician.
- **Is the correct power supply available?**
Electric dryers require 220-240 volt power supply. Check with a qualified electrician.
- **Was a regular fuse used?**
Use a time-delay fuse.
- **Is the dryer door firmly closed?**
- **Was the Start button firmly pressed?**

Unusual sounds

- **Has the dryer had a period of non-use?**
If the dryer hasn't been used for a while, there may be a thumping sound during the first few minutes of operation.
- **Is a coin, button, or paper clip caught between the drum and front or rear of the dryer?**
Check the front and rear edges of the drum for small objects. Clean out pockets before laundering.
- **Are the four legs installed, and is the dryer level front to back and side to side?**
The dryer may vibrate if not properly installed. See the Installation Instructions.
- **Is the clothing knotted or balled up?**
When balled up, the load will bounce, causing the dryer to vibrate. Separate the load items and restart the dryer.

Timer does not noticeably advance

- **Is the dryer set to Timed or Air Dry?**
The timer moves slowly and continuously for the time setting.
- **Is the dryer set to Automatic Drying?**
The timer moves only when the clothing is mostly dry. See "How Automatic Drying Works" in "Dryer Use."

Dryer Results

Clothes are not drying satisfactorily, drying times are too long, or load is too hot

- **Is the lint screen clogged with lint?**
Lint screen should be cleaned before each load.

WARNING



Fire Hazard

Use a heavy metal vent.
Do not use a plastic vent.
Do not use a metal foil vent.
Failure to follow these instructions can result in death or fire.

- **Is the exhaust vent or outside exhaust hood clogged with lint, restricting air movement?**
Run the dryer for 5-10 minutes. Hold your hand under the outside exhaust hood to check air movement. If you do not feel air movement, clean exhaust system of lint or replace exhaust vent with heavy metal or flexible metal vent. See the Installation Instructions.
- **Are fabric softener sheets blocking the grille?**
Use only one fabric softener sheet, and use it only once.
- **Is the exhaust vent the correct length?**
Check that the exhaust vent is not too long or has too many turns. Long venting will increase drying times. See the Installation Instructions.
- **Is the exhaust vent diameter the correct size?**
Use 102 mm (4") diameter vent material.

WARNING



Explosion Hazard

Keep flammable materials and vapors, such as petrol, away from dryer.
Place dryer at least 460 mm (18 inches) above the floor for a garage installation.
Failure to do so can result in death, explosion, or fire.

- **Is the dryer located in a room with temperature below 7°C (45°F)?**
Proper operation of dryer cycles requires temperatures above 7°C (45°F).

- **Is the dryer located in a closet?**
Closet doors must have ventilation openings at the top and bottom of the door. The sides and front of the dryer require a minimum of 25 mm (1") of airspace, and the rear of the dryer requires 127 mm (5"). See the Installation Instructions.
- **Has an air dry cycle been selected?**
Select the right cycle for the types of garments being dried.
- **Is the load too large and heavy to dry quickly?**
Separate the load to tumble freely.

Cycle time too short

WARNING

Excessive Weight Hazard

Use two or more people to move and install dryer.
Failure to do so can result in back or other injury.

- **Is the automatic cycle ending early?**
Change the load type setting on Automatic Cycles. Increasing or decreasing the dryness level will change the amount of drying time in a cycle.

Lint on load

- **Is the lint screen clogged?**
Lint screen should be cleaned before each load.

Stains on load or drum

- **Was dryer fabric softener properly used?**
Add dryer fabric softener sheets at the beginning of the cycle. Fabric softener sheets added to a partially dried load can stain your garments.

Drum stains are caused by dyes in clothing (usually blue jeans). This will not transfer to other clothing.

Loads are wrinkled

- **Was the load removed from dryer at the end of the cycle?**
- **Was the dryer overloaded?**
Dry smaller loads that can tumble freely.

Odors

- **Have you recently been painting, staining, or varnishing in the area where your dryer is located?**
If so, ventilate the area. When the odors or fumes are gone from the area, rewash and dry the clothing.
- **Is the electric dryer being used for the first time?**
The new electric heating element may have an odor. The odor will be gone after the first cycle.

ASSISTANCE OR SERVICE

Before calling for assistance or service, please check the “Troubleshooting” section. It may save you the cost of a service call. If you still need help, follow these instructions.

If you need assistance or service

If your problem is not due to any of the items listed in the “Troubleshooting” section, contact the dealer from whom you purchased the dryer, or a designated Whirlpool service company.

When calling, please know the purchase date, and the complete model and serial number of your appliance. This information will help us better respond to your request.

For further assistance

If you need further assistance, you can write or call with any questions or concerns at:

Whirlpool UK Ltd.
209 Purley Way
Croydon
CR9 4RY
U.K.
Telephone: 0208 649 5000

Free Manuals Download Website

<http://myh66.com>

<http://usermanuals.us>

<http://www.somanuals.com>

<http://www.4manuals.cc>

<http://www.manual-lib.com>

<http://www.404manual.com>

<http://www.luxmanual.com>

<http://aubethermostatmanual.com>

Golf course search by state

<http://golfingnear.com>

Email search by domain

<http://emailbydomain.com>

Auto manuals search

<http://auto.somanuals.com>

TV manuals search

<http://tv.somanuals.com>