

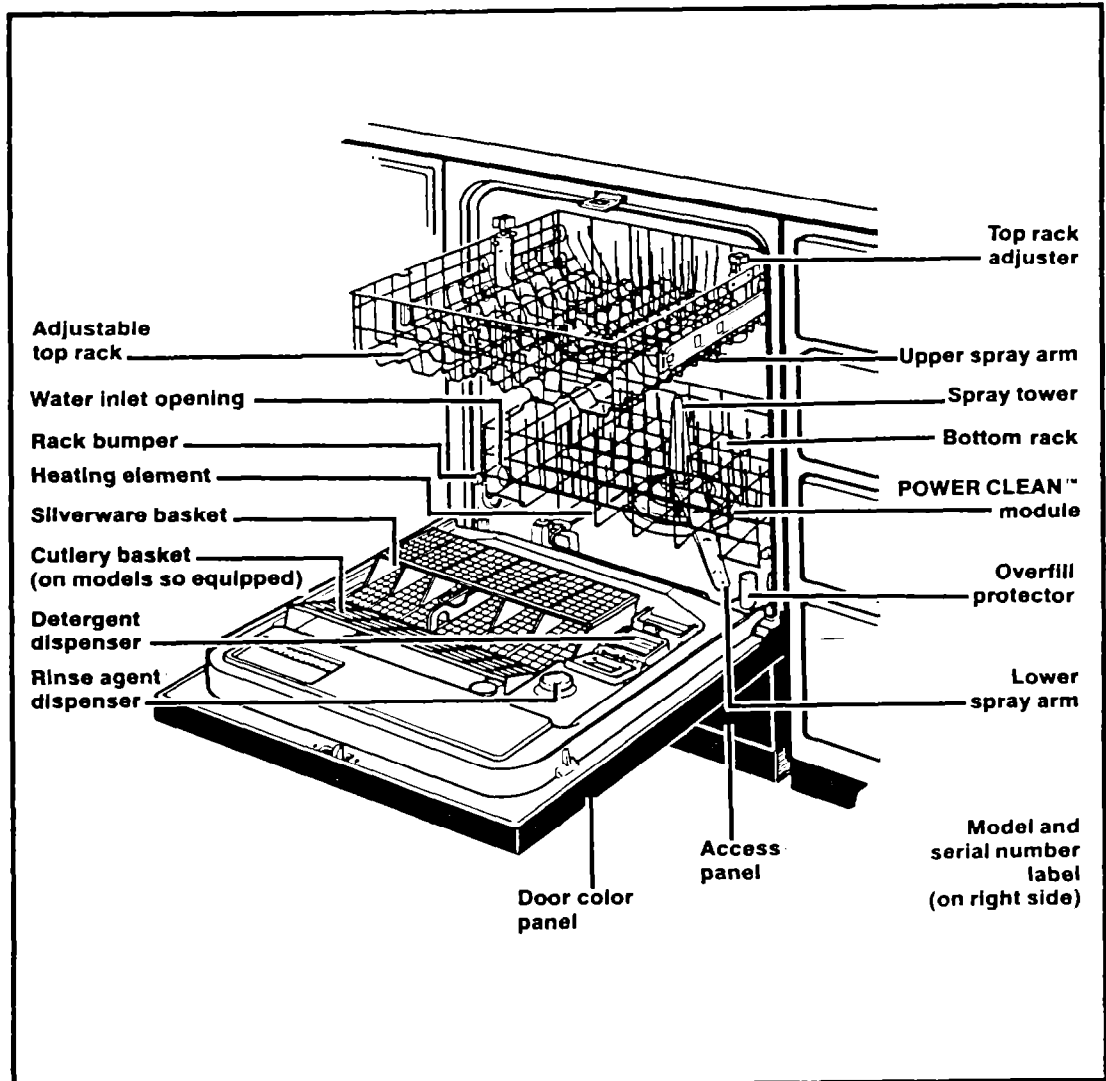

# Use & Care Guide



## 9200 SERIES DISHWASHERS

# Contents

	Page
<b>Important Safety Instructions</b> .....	3
<b>Operating Instructions</b> .....	3
Using your dishwasher for the first time ..	3
Before starting your dishwasher .....	3
Starting your dishwasher .....	4
Changing a cycle setting .....	4
Delaying a wash .....	5
The CANCEL/DRAIN pad .....	5
Using cycle pause .....	5
Control panel lock-out feature .....	6
The beeping sound .....	6
The WATER HEATING signal light .....	7
The CLEAN signal light .....	7
What happens in each cycle .....	8
What happens in each option .....	10
<b>Proper Loading</b> .....	11
<b>Adding Detergent</b> .....	14
<b>Using Rinse Agent Dispenser</b> .....	15
<b>For Best Results</b> .....	16
Special tips .....	16
<b>Common Dishwashing Problems</b> .....	18
<b>If You Need Service Or Assistance</b> .....	20
<b>Whirlpool Dishwasher Warranty</b> .....	24

©1991 Whirlpool Corporation

## It is your responsibility to be sure your dishwasher:

- Is installed by a qualified installer.
  - Has been installed where it is protected from the elements.
  - Has been installed on a floor strong enough to support its weight.
  - Has been properly connected to electricity, water and drain.\*
  - Has been properly electrically grounded.
  - Has had all hang tags and temporary labels removed.
  - Is not used by children or anyone unable to operate it properly.
  - Is properly maintained.
- \*See Installation Instructions for complete information.

**Thank you for buying a Whirlpool appliance. Please complete and mail the Owner Registration Card provided with this product.**

Then complete the form below. Have this information ready if you need service or call with a question.

- Copy model and serial numbers from label (see diagram on front cover) and purchase date from sales slip.
- Keep this book and sales slip together in a handy place.

---

**Model Number**

---

**Serial Number**

---

**Purchase Date**

---

**Service Company Phone Number**

If you need service, first see the "Service and Assistance" section of this book. After checking "Service and Assistance," additional help can be found by calling our Consumer Assistance Center telephone number, **1-800-253-1301**, from anywhere in the U.S.

# Important Safety Instructions

## **WARNING**

To reduce the risk of fire, electrical shock, or injury when using your dishwasher, follow basic precautions including the following:

- **Read all instructions before using the dishwasher.**
- Properly connect to electricity and water.
- **DISHWASHER MUST BE ELECTRICALLY GROUNDED.** Read the Installation Instructions for details.
- Be sure your dishwasher is installed on a level floor that will hold the weight, and in an area suitable for its size and use.
- When discarding an old dishwasher, always remove the door to prevent accidental entrapment or suffocation.
- **REMEMBER**, use your dishwasher only for the job it was designed to do.
- Store dishwasher detergent in a cool, dry place **WHERE CHILDREN CAN'T REACH IT.**
- Use **ONLY** detergents and rinse agents recommended for use in a dishwasher.
- Locate sharp items and knives so that they are not likely to damage door seal or cut the user.
- **DO NOT** let children play in or on the dishwasher.
- **DO NOT** reach into the area below the bottom rack until the heating element has cooled for at least 20 minutes.
- **DO NOT** wash plastic items unless marked "Dishwasher Safe" or the equivalent. If not marked, check manufacturer's recommendations.
- **DO NOT** use your dishwasher unless all enclosure panels are properly in place.
- **DO NOT** sit on, stand on or abuse the dishwasher door or dish racks.
- **DO NOT** tamper with controls.
- **If hot water has not been used recently (usually two weeks or longer), hydrogen gases may build up in the water heater and the hot water pipes. HYDROGEN GAS IS EXPLOSIVE. To prevent injury or damage, before using your dishwasher, turn on all hot water faucets and allow water to run for several minutes. This will allow gases to escape. Do not smoke or use any open flame near the faucet while it is open.**
- **Disconnect electrical power to the dishwasher before attempting to service.**
- **DO NOT** store or use gasoline or other flammable vapors and liquids in the vicinity of this or any other appliance. The fumes can create a fire hazard or explosion.

– SAVE THESE INSTRUCTIONS –

## Operating Instructions

### Using your dishwasher for the first time

When first installed, the signal lights will flash rapidly in order. The signal lights will also flash following a power failure. Press the CANCEL pad **twice** to clear the signal lights.

Five control pads and the signal lights allow you to set and check the dishwasher's function. A "beep" sounds each time a pad is pressed under normal conditions.

The dishwasher is preset for the Normal Cycle with the Heat Dry Option. After each use, the dishwasher remembers the last cycle and options used. The next time the display is lit up for selection, it will show the last selection that was run.

### Before starting your dishwasher

1. Properly load the top and bottom racks, the silverware basket and, on models so equipped, the cutlery basket.
2. Spin the Upper and Lower Spray Arms to make sure nothing will stop them from turning freely.
3. Add detergent. See page 14.
4. Check rinse agent dispenser. See page 15.
5. Push door firmly when closing and it will automatically latch. Avoid touching control pads while door is open or being closed.
6. Run hot water at sink nearest dishwasher until it is hot. Turn it off.

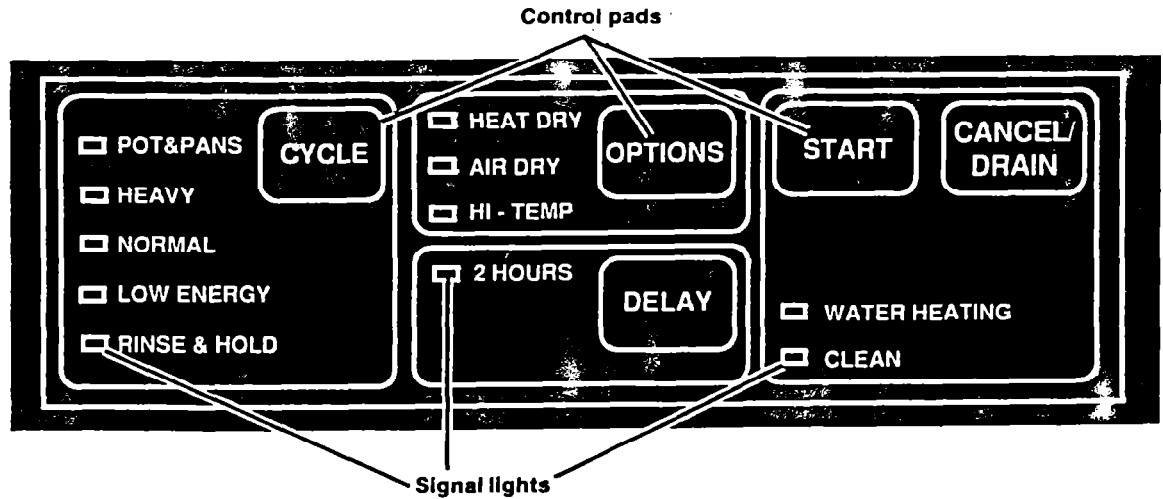

## Starting your dishwasher

1. Press the START pad once to display the cycle and options. Skip to Step 4 if you want to run the cycle and options shown by the lights.
2. Press the CYCLE pad until the cycle you want is indicated by a signal light. Each press of the CYCLE pad advances the signal light to the next cycle.
3. Press the OPTIONS pad until the option you want is indicated by a signal light. Each press of the OPTIONS pad advances the signal light to the next option.
4. Press the START pad again.

**NOTE:** Cycle and option selections are cancelled by a power failure.

## Changing a cycle setting

You can change a setting anytime during any cycle.

1. Press the CANCEL/DRAIN pad. The dishwasher will go into a 2-minute drain cycle, if needed.
2. Select a new cycle and option.
3. Be sure the detergent dispensers are filled properly for the new cycle.
4. Press the START pad. The dishwasher will start the new cycle.

---

**DELAY**

**CYCLE**

**OPTIONS**

**DELAY**

**2 HOURS**

---

**CANCEL/  
DRAIN**

---

**DELAY**

**START**

## Delaying a wash

The DELAY pad allows you to delay the start of a cycle for 2 hours after loading the dishwasher. For example, use the DELAY to run the dishwasher during off-peak hours of electrical use.

1. Press the DELAY pad once to display the last cycle and options selection.
2. Select a new cycle and option(s), if desired.
3. Press the DELAY pad again to select a 2-hour delay. The 2 HOURS signal light will come on.  
**NOTE:** Immediately pressing the DELAY pad again will cancel the selection. If no delay is selected, the 2 HOURS signal light will be off.
4. After 2 hours, the signal light will turn off and the dishwasher will start.

### **NOTE:**

- You may press the START pad at any time during the delay if you want the dishwasher to start immediately.
- You may press the CANCEL/DRAIN pad to cancel the delay and clear the delay signal light.
- You may add items to the load at any time during the delay. **Close the door firmly to latch it.**

## The CANCEL/DRAIN pad

The CANCEL/DRAIN pad allows you to cancel a cycle, to clear the signal lights or to make a new selection. If the dishwasher is washing, it will go into a 2-minute drain automatically before shutting off. Pressing CANCEL/DRAIN again stops the drain. If the dishwasher had not been started or is not washing, it will clear the display. Pressing CANCEL/DRAIN again will start a 2-minute drain, if needed.

## Using cycle pause

A cycle can be stopped at any time for up to 10 minutes.

1. Press the DELAY pad. Any signal lights that are on will flash slowly until the cycle restarts after 10 minutes.
2. The cycle can be started sooner by pressing the START pad.

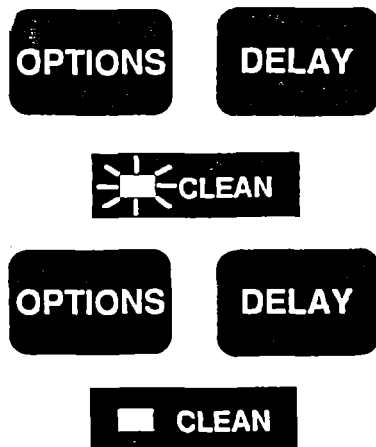

## Control panel lock-out feature

This feature lets you lock-out the function of the control pads (except to cancel or pause a cycle that is running). When the control panel is locked-out, the dishwasher cannot be started and a running cycle cannot be changed.

### To use the lock-out feature:

1. Press and hold the OPTIONS and DELAY pad until the CLEAN signal light flashes.
2. Release the pads. The CLEAN signal light will stop flashing.

### To cancel the lock-out feature:

1. Press and hold the OPTIONS and DELAY pad until the CLEAN signal light turns on and stays on.
2. Release the pad. The CLEAN signal light will turn off.

---

## The beeping sound

Each time a control pad is pressed, a single "beep" sound is made. A double beep means one of the extra features was selected (such as control panel lock-out) or the wrong control pad was used.

### To turn off the beep:

1. Press and hold the OPTIONS pad until the CLEAN signal light flashes.
2. Release the pad. The CLEAN signal light will turn off.

**NOTE:** A power failure will reset this feature. You will have to redo the above steps.

### To turn the beep back on:

1. Press and hold the OPTIONS pad until the CLEAN signal light turns on and stays on.
2. Release the pad. The CLEAN signal light will turn off.

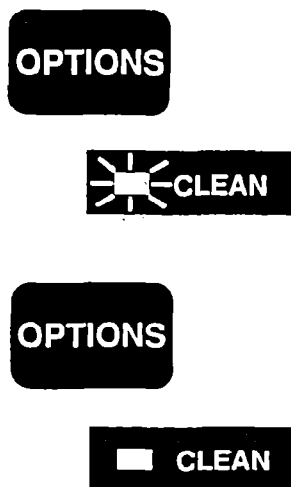

---

**WATER HEATING**

### The WATER HEATING signal light

The WATER HEATING signal light comes on during the water heating portions of the Pots & Pans Cycle. The signal light will also come on during the water heating portion of other cycles when the Hi-Temp Option is selected.

The WATER HEATING signal light will flash at the end of the cycle if the water did not heat to 140°F (60°C). If you want to make sure the water gets heated to 140°F (60°C), use the Hi-Temp Option (see page 10).

When the signal light is on, water is being heated. The heating time is based on the temperature of the water supply as it enters the dishwasher. The cooler the water, the longer the heating time. The WATER HEATING signal light will go off when the water temperature reaches 140°F (60°C).

---

**CLEAN**

### The CLEAN signal light

The CLEAN signal light comes on at the end of a cycle to show that the load is clean. It will stay on until CANCEL/DRAIN or any other control pad is pressed.

As an option, you can have the CLEAN light turn off the first time you open the door after a cycle is finished:

1. Press and hold the CYCLE pad until the CLEAN signal light starts flashing.

2. Release the pad. The CLEAN signal light will turn off.

**NOTE:** A power failure will reset this feature. You will have to redo the above steps.

To again have the signal light stay on when the door is opened:

1. Press and hold the CYCLE pad until the CLEAN signal light turns on.

2. Release the pad. The CLEAN signal light will turn off.



## What happens in each cycle

### Pots & Pans Cycle

A double wash with maximum cleaning for cooked-on or baked-on foods. Cycle time\* is about 73 minutes plus the time needed while the timer delays to heat the water (marked †) to 140°F (60°C) in both washes and the last rinse.

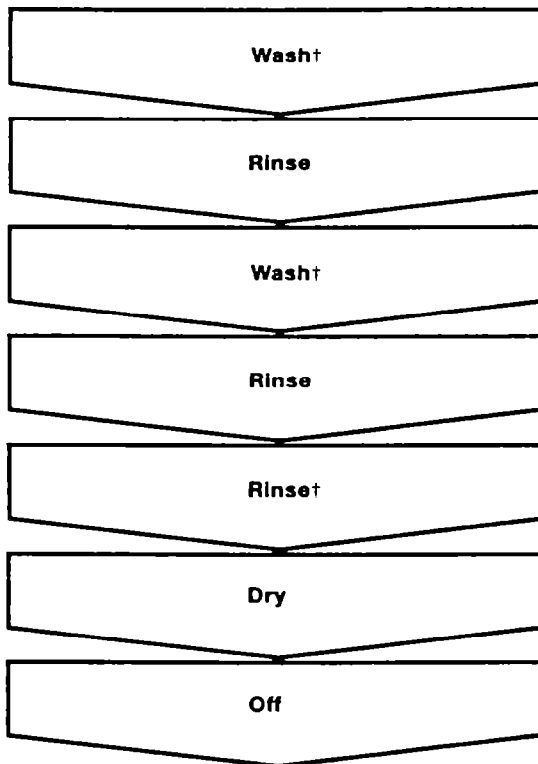
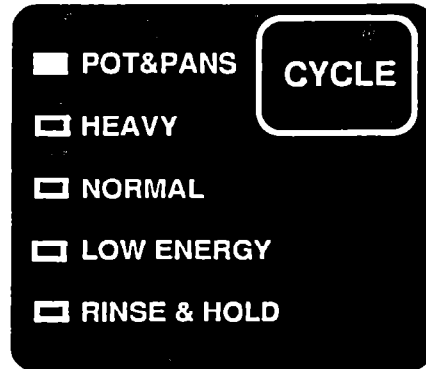

### Heavy Cycle

A double wash for heavily soiled loads. Cycle time\* is about 73 minutes plus the time needed while the timer delays to heat the water to 140°F (60°C) in the main wash (marked †) and, if the Hi-Temp Option is selected, in the first wash and final rinse (marked ††).

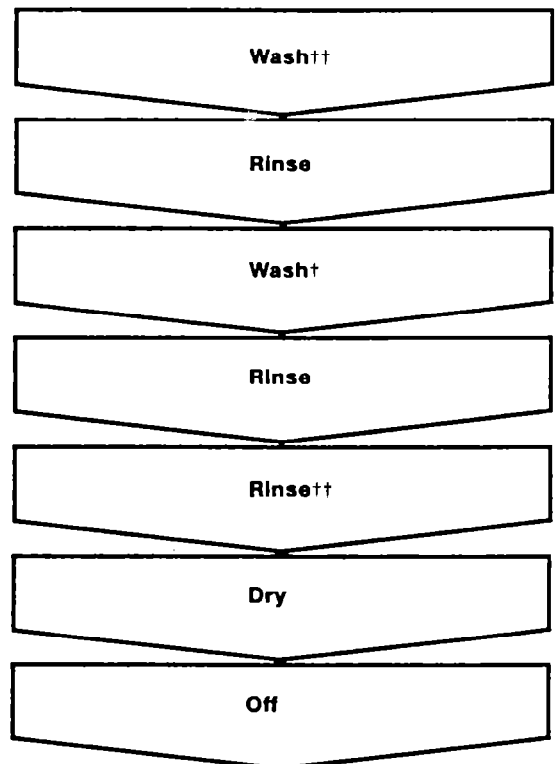
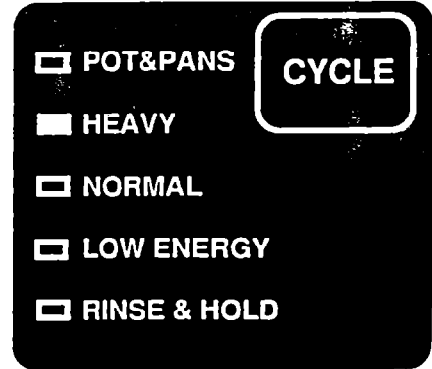



**Normal Cycle**

A single wash for normal, everyday soiled loads. (The Energy Guide Label is based on this cycle.) Cycle time\* is about 66 minutes plus the time needed while the timer delays to heat the water to 140°F (60°C) in the wash (marked †) and, if the Hi-Temp Option is selected, in the final rinse (marked ††).

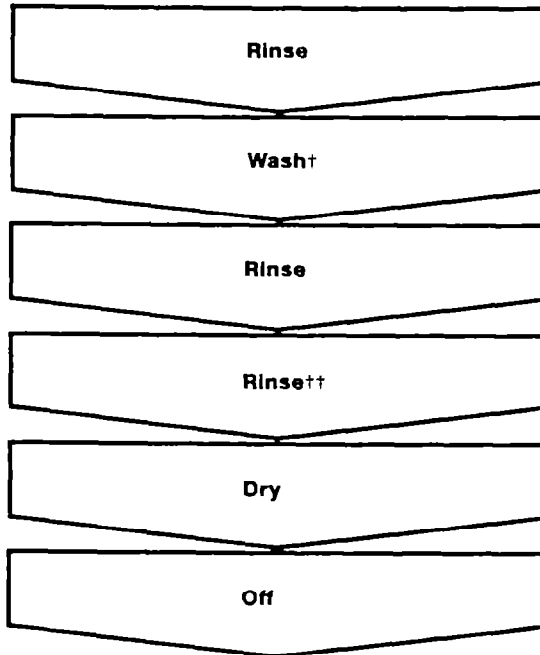
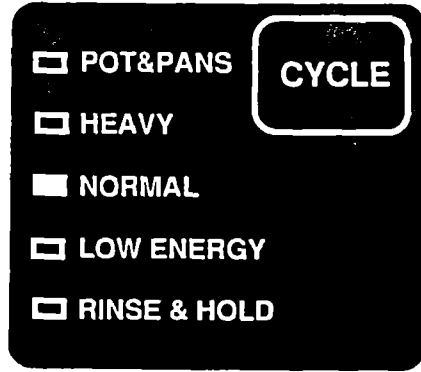

**Low Energy Cycle**

A single wash for pre-rinsed or lightly soiled loads. Cycle time\* is about 58 minutes plus the time needed while the timer delays to heat the water to 140°F (60°C) in the wash (marked †) and, if the Hi-Temp Option is selected, in the final rinse (marked ††).

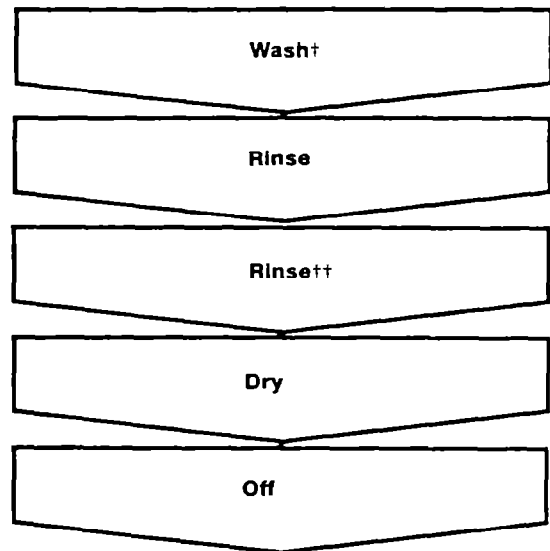
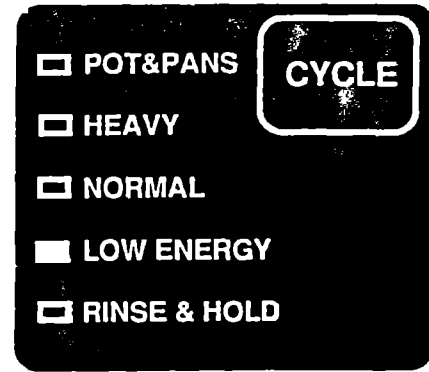

\*Cycle time includes heated dry times.

Operating Instructions  
Continued

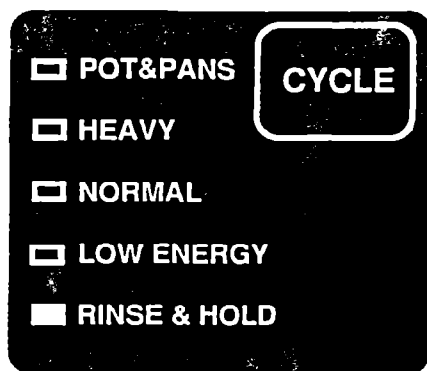

### Rinse & Hold Cycle

For rinsing a few items to be washed one or more days later. Cycle time is about 12 minutes.

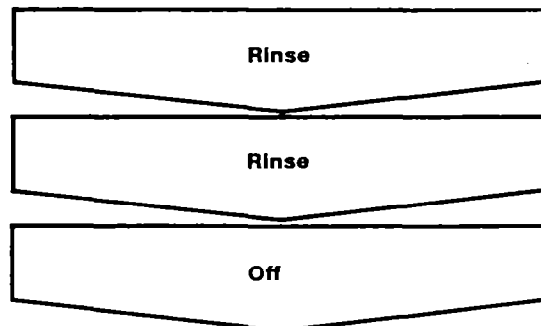

### What happens in each option

Options can be selected by pressing the OPTIONS pad. Each press of the pad advances the selection to the next option. You can select Heat Dry, Heat Dry and Hi-Temp, Air Dry, or Air Dry and Hi-Temp. For example, if the AIR DRY signal light is on and you want to select the Heat Dry Option, press the OPTIONS pad twice.

#### NOTE:

- All options can be changed any time during a cycle.
- The Hi-Temp Option is preset for the Pots & Pans Cycle, only Heat Dry or Air Dry Options can be selected.
- If the Rinse & Hold Cycle is selected, options are not available.

#### Heat Dry Option

The HEAT DRY signal light will be on when the Heat Dry Option is selected. Heat dry means the air in the dishwasher is heated during the "dry" portion of any cycle – except the Rinse & Hold Cycle.

For best drying results, use a liquid rinse agent such as Jet-Dry.<sup>®</sup>

#### Air Dry Option

The AIR DRY signal light will be on when the Air Dry Option is selected. The Air Dry Option helps save energy, but the load takes longer to dry (overnight) and some spotting may result. Some items (such as plastics) may need towel drying.

For best drying results, use a liquid rinse agent such as Jet-Dry.<sup>®</sup>

#### Hi-Temp Option

When the Hi-Temp Option is selected, water for the first wash (if present), main wash and the final rinse is heated to 140°F (60°C). While the water is heating, the WATER HEATING signal light will be on. Pots & Pans Cycle has the Hi-Temp Option preset. Hi-Temp Option cannot be selected with the Rinse & Hold Cycle.



# Proper Loading

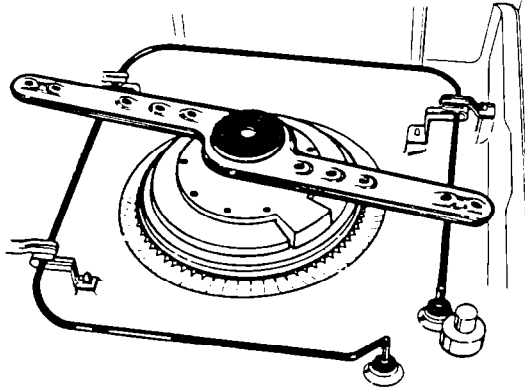

## Preparation for loading

It is not necessary to rinse dishes before putting them into the dishwasher. Just remove large pieces, bones and other hard items. The POWER CLEAN™ Module will remove food particles from the water. It contains a chopping device which will reduce the size of food items.

If hard items such as fruit seeds, nuts and egg shells enter the POWER CLEAN Module, you might hear chopping, grinding, crunching or buzzing sounds. Those sounds are normal when hard items enter the module. **Do not** let metallic items (i.e. pot handle screws) get into the POWER CLEAN Module. This could result in damage to the POWER CLEAN Module.

Always load dishes so soiled surfaces are reached by spray from rotating spray arms. Water must be able to drain off completely for best drying results. Be careful to separate items so spray can reach all surfaces.

## Top rack loading

The top rack is designed for cups, glasses and smaller items.

### Cup and glass load

- Place so open ends face down for cleaning and draining.
- **Load glasses in top rack only.** Bottom rack is not designed for glasses. Damage may occur.
- Place items in the rows **between** prongs. Placing them **over** the prongs can lead to breakage.
- Be sure lightweight items are held firmly in place.
- China, crystal and other delicate items must not touch each other during dishwasher operation. Damage may occur.

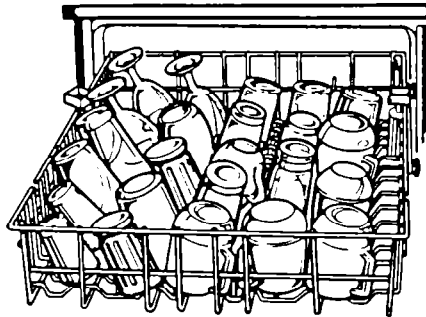

Cup and glass load

### Mixed load

- Load plastic items **only in the top rack.** Only plastic items marked "dishwasher safe" are recommended.
- Load plastic items so the force of the spray does not move them during the cycle.
- Plastic items can be melted in the bottom rack.

### Utensil load

- Small bowls, pans and other utensils can be placed in the top rack.

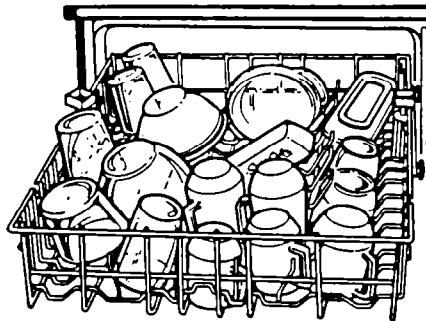

Mixed load

## Proper Loading Continued

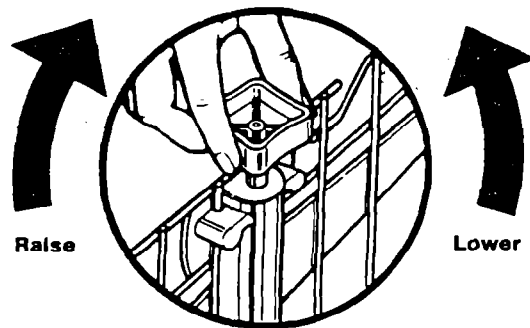

### Adjustable top rack

The top rack does not have to be level.

- Raise or lower one or both sides to help fit tall items in the top or bottom rack.
- Turn knob clockwise to raise a side.
- Turn knob counterclockwise to lower a side.

### Bottom rack loading

Items with cooked-on or dried-on food should be loaded in the bottom rack, with soiled surfaces facing inward to the spray.

### Mixed load

- Make sure pot handles and other items do not stop rotation of either the upper or lower spray arm. Spray arms must move freely.
- Load items so they do not block or cover the spray tower.
- Securely place heavily soiled cookware face down in rack.

### Dish load

- Place plates, soup bowls, etc., **between** prongs and facing inward to the spray.
- Do not place items directly over spray tower.

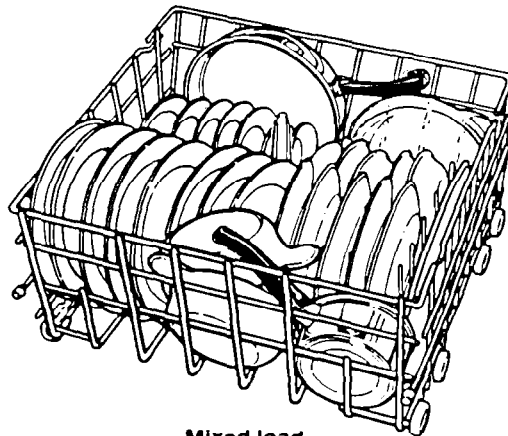

Mixed load

### Utensil load

- Load cookie sheets, cake pans and other large items at sides and back. Loading such items in front may keep water spray from reaching detergent dispenser and silverware basket.

### NOTE:

- Do not load glasses, cups or plastic items in the bottom rack.
- When lower rack is removed, replace with bumpers in front.

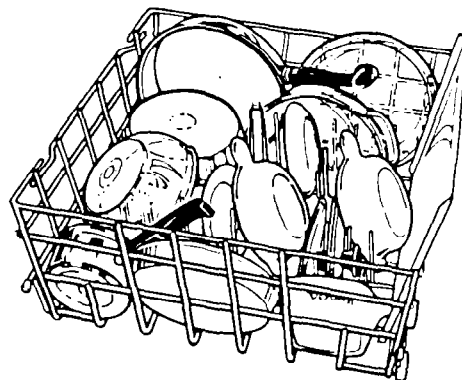

Utensil load

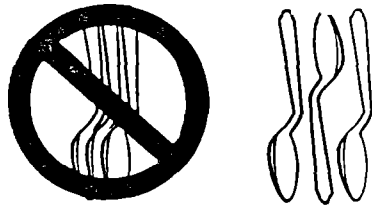

**Silverware basket loading**

Load forks and spoons so they **don't nest together**. Spray can't reach nested items.

Mix items in each section of the basket. Small items – baby bottle caps, jar lids, etc. – can be put in any section.

The silverware basket can be loaded while it's in place on the door, or it can be taken out for loading on the counter or table.

It can also be removed for easy unloading. Always unload or remove the basket before unloading the racks to avoid spilling water droplets on the silverware.

**To remove the basket**, slide it toward the top of the door – by the handle. Lift it off the holding buttons. Replace it in reverse order.

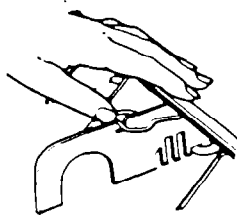
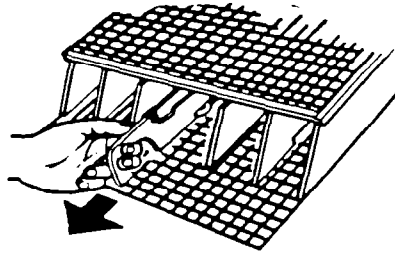

**To open the basket**, unhook the latch as shown. Be sure the cover is completely latched before pulling out the bottom rack and before closing the dishwasher door.

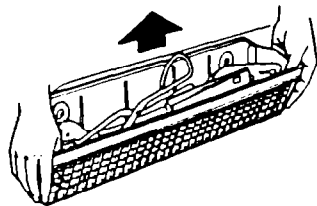

**⚠WARNING**

**Personal Injury Hazard**

To avoid cuts from sharp items (knives, forks, skewers, etc.), make sure these items are put in point down.

**Cutlery basket loading (on models so equipped)**

Remove and replace the cutlery basket in the same way as the silverware basket. Use the cutlery basket for long items. Remove the basket and tip contents onto a cutting board to unload. This can help avoid accidents with sharp points and edges.

# Adding Detergent

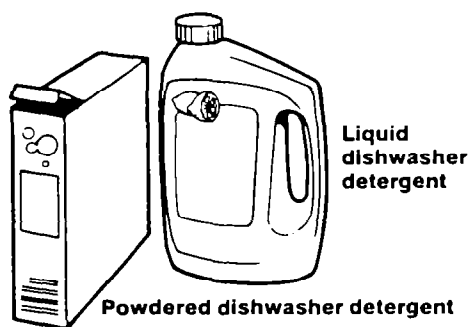

See phosphorus content on product labels.

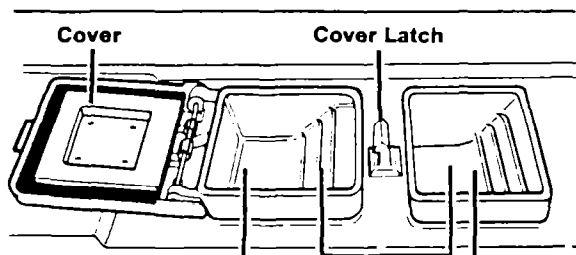

Use covered section for...  
Normal Cycle

Use open section for...  
Low Energy Cycle

Use both sections for...  
Pots & Pans Cycle  
Heavy Cycle

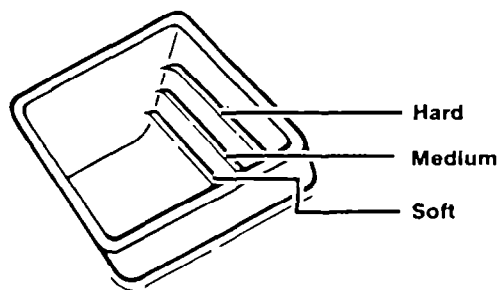

## What kind of detergent to use

### Use automatic dishwasher detergent only.

Other detergents are too mild and much too sudsy to work in the dishwasher.

Different brands of dishwasher detergent have different amounts of phosphorus for softening water. If water is hard and phosphorus content is low (6.0% or less), you may need to use more detergent or use a brand with a higher phosphorus content (8.7% or higher).

Do not add detergent until you are ready to wash. **Fresh automatic dishwasher detergent is necessary for best washing results.**

Store detergent tightly closed in a cool, dry place.

## The detergent dispenser

The detergent dispenser has one section with a cover and one without.

- For cycles with one wash, put detergent in one section only.
  - Use the **open** section if the cycle begins with a wash.
  - Use the **covered** section if the cycle begins with a rinse.

- For cycles with two washes, put detergent in both sections.

- Push the cover down until it is latched.

Detergent in the open section falls into the dishwasher when the door is closed. The covered section opens automatically when the main wash starts.

**NOTE:** It is normal for the cover to open partially when dispensing detergent. The cover will open fully when the door is opened.

## How much detergent to use

The amount of detergent to use depends on the hardness of your water. If too little is used, dishes won't be clean. However, if too much is used in soft water, glassware will begin to etch.

Find out your water's hardness by asking your local water department, water softener company or county extension agent.

- **HARD** – Fill 1 or both sections to top line if water hardness is 8 or more grains per gallon, or 136 or more parts per million.
- **MEDIUM** – Fill 1 or both sections to middle line if water hardness is 5 to 7 grains per gallon, or 85 to 119 parts per million.
- **SOFT** – Fill 1 or both sections to bottom line if water hardness is 0 to 4 grains per gallon, or 0 to 68 parts per million.

# Using Rinse Agent Dispenser

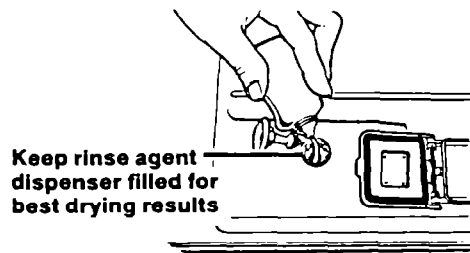

Keep rinse agent dispenser filled for best drying results

## Rinse agent dispenser

Keep the rinse agent dispenser filled with a liquid rinse agent such as Jet-Dry.<sup>®</sup> **A rinse agent greatly improves the drying of dishes by helping water flow off of them during the last rinse.** A rinse agent also keeps water from forming droplets and drying as spots. A small amount of rinse agent is automatically released into the rinse water during the final rinse of each cycle.

**For best drying results, check the dispenser periodically to see if it needs refilling.** The center of the Fill Indicator Cap will be clear when dispenser needs refilling. An "E" will also be visible inside the dispenser when the cap is removed and the dispenser is empty.

The dispenser will hold 6 ounces of rinse agent. Under normal conditions, this will last about 3 months. You do not have to wait until the dispenser is empty to refill it, but do not overfill it.

Make sure the dishwasher door is fully open when filling the dispenser. Do not fill past the smallest opening in the lower part of the dispenser. If you overfill, excess rinse agent can come out. This will not harm the dishwasher, but could cause over-sudsing. Clean up any spilled rinse agent with a damp cloth. Replace the Fill Indicator Cap and keep it tightly closed.

**NOTE:** Because your dishwasher is designed to use a liquid rinse agent, you do not need to use a solid or bar-type rinse agent.

® Registered Trademark of  
Benckiser Consumer Products, Inc.

# For Best Results

## Hot water is a must

Hot water dissolves and activates the dishwashing detergent. Hot water dissolves grease on dishes and helps dry glasses spot-free. Make certain loads are washed in hot water. Two ways to have a reliable hot water supply...

1. Maintain a 140°F (60°C) water supply at central water heater. To check water temperature, turn on hot water faucet nearest the dishwasher. Let water run until it is as hot as possible, then check with a candy or meat thermometer. If the temperature at the faucet is below 135°F (57°C), have a qualified person raise the water heater thermostat setting.
2. Use the Hi-Temp Option. If water heating is needed, a thermostat will delay the cycle while the dishwasher heats the water until the temperature reaches 140°F (60°C). If water is hot enough, the cycle will proceed with no delay. This lets you turn down your water heater, if you choose, without cutting back on hot water needed for good dishwashing.

## Quiet operating tips

To avoid thumping and clattering noises during operation:

- Make sure lightweight load items are secured in the rack.
- Make sure pot lids and handles, pizza pans, cookie sheets, etc. do not touch interior walls or interfere with either of the spray arms rotation.
- Load dishes so they **don't** touch one another.

**NOTE:** Keep sink drain plugs inserted during dishwasher operation to prevent noise transfer through drains.

## Special tips

Remember, use your dishwasher only for the job it was designed to do. Some items are not dishwasher safe or may require special care. Read these special tips for the following items:

**Aluminum:** Aluminum loses its bright, shiny appearance and darkens in color due to minerals in the water and the alkalinity of the dishwasher detergent. Colored aluminum may fade.

**TIPS:** If washed in the dishwasher avoid placing directly in front of detergent dispenser where it could be sprinkled with undissolved detergent, causing spotting, pitting, and discoloration. Follow utensil manufacturer's cleaning instructions.

**China:** Check manufacturer's recommendations. Hand-painted, metal-trimmed, and antique china fade due to high water temperatures and alkaline detergent solution in the dishwasher.

**NOTE:** Delicate, antique items should not be washed in the dishwasher.

**TIPS:** Load china carefully. **Do not** allow pieces to touch each other. Test one piece by washing it daily in the dishwasher for several weeks. Then compare it with the rest of the set to see if colors have changed.

**Crystal and decorative glasses:** Crystal can break from sudden exposure to high water temperature. Metal trim and colorful decoration on glass will fade in time when washed in the dishwasher.

**NOTE:** Delicate, antique items should not be washed in the dishwasher.

**TIPS:** Load crystal carefully in **top rack only**. Be sure to load a few larger items in the bottom rack to reduce amount of force of water spray reaching glassware from lower spray arm. Use the shortest cycle.

**Flatware:** Salty and acidic food may tarnish silver and stainless flatware if allowed to remain on the utensils. A film may form on sterling silver and silver plate items washed in a dishwasher. This film is caused by reaction of silver with chlorine in the detergent. **Gold flatware is not dishwasher safe.** The adhesive used in some flatware with hollow handles is not heat resistant, causing the handles to come off in the dishwasher. Wash by hand.

**TIPS:** Rinse flatware as soon as possible, especially if it is not to be washed right away. Dishwasher detergent may remove antique finishes. Wash by hand. Tarnish and film build-up can be removed with silver polish.

**Cast iron utensils:** The seasoned finish will be removed in the dishwasher. Rusting will result.

**TIPS:** Wash by hand. To re-season, coat with unsalted fat and heat in a slow oven for an hour or two.

**Plastics:** Many plastics will have "Dishwasher Safe" written on them. Some plastics are heat sensitive and may melt or warp.

**TIPS:** If in doubt, try one piece. Place in upper rack only. Air Dry Option provides additional protection.

**Non-stick finish utensils:** Most can be washed in the dishwasher.

**TIPS:** Follow manufacturer's suggestions.

**Wood:** Many wooden items will crack and warp or lose their finish.

**TIPS:** **Do not** wash cutting boards, wooden salad bowls or knives with wooden handles in the dishwasher.

**Pewter or pewter-like materials:** Items may streak, discolor, and pit.

**TIPS:** To keep pewter at its very best, hand wash with mild detergent.



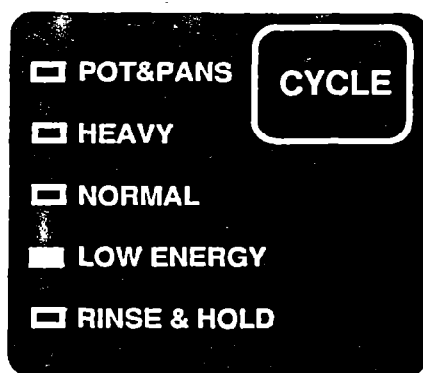

### Energy saving tips

You can help save energy if you:

- 1. Wash full loads.** Running a half-filled dishwasher uses the same amount of electricity and hot water as a fully loaded machine.
- 2. Use the Low Energy Cycle whenever possible.** It uses less hot water and energy than other cycles.
- 3. Air dry dishes** when you don't need a rapid drying cycle. Allow longer drying times (overnight). Use a rinse agent to improve drying.
- 4. Load correctly** for best washing results. Incorrect loading may cause poor washing and the need to rewash all or part of the load.
- 5. Do not pre-rinse normally soiled dishes.** Select the correct cycle for the load and use the recommended amount of detergent for good washing results without hand rinsing.
- 6. Use your dishwasher** during off-peak hours. Local utilities recommend this to avoid heavy usage of energy at certain times of day.

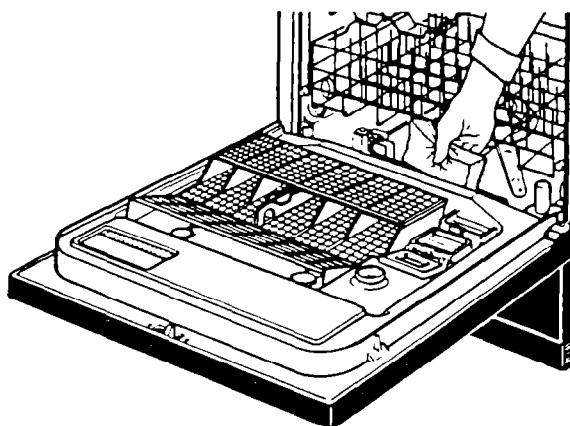

### Dishwasher care & cleaning

**Exterior** – Regular use of a soft, damp cloth or sponge and a mild detergent is all that is necessary, in most cases, to keep the outside of your dishwasher nice looking and clean.

**Interior** – Hard water minerals may cause a white film to build-up on the inside surfaces, especially just beneath the door area. To clean dishwasher interior:

1. Apply powdered dishwasher detergent to a damp sponge to make a paste.  
OR
2. Use liquid automatic dishwasher detergent and clean with damp sponge.

Wear rubber gloves. **Do not** use any type of cleanser other than automatic dishwasher detergent because it may cause foaming or sudsing.

# Common Dishwashing Problems

## **Spotting and filming** (hard water film)

### **Hard water**

Fill detergent dispensers to capacity. Use dishwasher detergent with highest available phosphorus content. May be necessary to install water softener.

To remove spots and film, try a vinegar rinse...

1. Wash and rinse load as usual. Use Air Dry Option.
2. Remove all metal items.
3. Put 2 cups (500 mL) white vinegar in a container on the bottom rack.
4. Run dishwasher through a complete washing cycle.

### **Water is not hot enough**

Water temperature should be at least 140°F (60°C). Set water heater thermostat to a higher setting. Run water at sink until hot before starting and/or use Hi-Temp Option.

### **Not enough detergent, or improper detergent**

Use more dishwasher detergent. Use detergent with highest available phosphorus content...especially with hard water.

### **"Old" detergent**

Use only fresh dishwasher detergent. Store **tightly closed** container, in cool, dry place. Discard old detergent. Do not fill dispensers until ready to start dishwasher.

### **Improper loading**

Make sure dishes and glassware are loaded so spray reaches all surfaces and items drain properly. Do not overload. Do not nest items. Make sure large items do not block spray from reaching detergent dispensers.

### **No rinse agent**

Does the rinse agent dispenser need filling? See instructions on page 15.

### **AIR DRY Setting used**

Drying without heat may result in some spotting of glasses and silver.

### **Small particles deposited on items**

#### **Spray arm or arms not rotating freely**

Check spray arms to make sure they turn freely after loading. Be sure a utensil has not prevented their turning.

### **"Old" detergent**

Use only fresh dishwasher detergent. Store **tightly closed** container, in cool, dry place. Discard old detergent. Do not fill dispensers until ready to start dishwasher.

### **Not enough detergent, or improper detergent**

Use more dishwasher detergent. Use detergent with highest available phosphorus content... especially with hard water.

### **Water is not hot enough**

Water temperature should be at least 140°F (60°C). Set water heater thermostat to a higher setting. Run water at sink until hot before starting and/or use Hi-Temp Option.

### **Water pressure may be low, dishwasher is not filling properly**

If water pressure is low, do not use water for other purposes while dishwasher is running (to assure correct fills).

### **Dishes not dry**

#### **No rinse agent**

Does the rinse agent dispenser need filling? See instructions on page 15.

### **Water is not hot enough**

Water temperature should be at least 140°F (60°C). Set water heater thermostat to a higher setting. Run water at sink until hot before starting and/or use Hi-Temp Option.

### **Improper loading**

Make sure dishes and glassware are loaded so spray reaches all surfaces and items drain properly. Do not overload. Do not nest items.

### **AIR DRY Setting used**

Allow more time when using Air Dry Option, or use Heat Dry Option. Plastic items may need towel drying.

### **Black marks on dishes**

#### **Aluminum utensils rubbing against items during washing**

**Use care** in loading aluminum utensils, especially any lightweight foil container. Place so they do not touch dishes. Remove black marks with plastic scouring pad and a mild abrasive cleanser.

### **Chipping or breaking glassware**

#### **Improper loading**

Do not overload. Load glasses in the top rack only. Load between prongs, not over them. Glasses loaded over prongs will not be supported and may chip or break.

**Dishes not washing clean****Water is not hot enough**

Water temperature should be at least 140°F (60°C). Set water heater thermostat to a higher setting. Run water at sink until hot before starting and/or use Hi-Temp Option.

**Improper loading**

Make sure dishes and glassware are loaded so spray reaches all surfaces and items drain properly. Do not overload. Do not nest items.

Make sure large items do not block spray from reaching detergent dispensers.

**Spray arm or arms not rotating freely**

Check spray arms to make sure they turn freely after loading. Be sure a utensil has not prevented their turning.

**Not enough detergent or improper detergent**

Use more dishwasher detergent. Use detergent with highest available phosphorus content... especially with hard water.

**"Old" detergent**

Use only fresh dishwasher detergent. Store **tightly closed** container, in cool, dry place. Discard old detergent. Do not fill dispensers until ready to start dishwasher.

**Water pressure may be low, dishwasher is not filling properly**

If water pressure is low, do not use water for other purposes while dishwasher is running (to assure correct fills).

**Cloudy film on glassware, etching – permanent corrosion****Too much detergent in soft water**

Check for rainbow hue on glasses. A rainbow hue is the first sign of etching (corrosion of glass). Reduce the amount of dishwasher detergent. Use a detergent with a lower phosphorus content.

**Inadequate rinsing**

If water pressure is low do not use water for other purposes while dishwasher is running (to assure correct water fills). Make sure dishes and glassware are loaded properly to assure adequate rinsing and draining. Do not overload.

**Dishes & interior of dishwasher yellow or brown****Iron or manganese in water****Temporary remedy:**

1. Set empty dishwasher for a "one wash" cycle.

2. Start dishwasher and unlatch door to stop it when it has filled for the wash part of the cycle.
3. Add ¼ to ½ cup (120 to 240 mL) of citric acid crystals (usually available in drugstores).
4. Close and latch door to complete cycle.

**Permanent solution:** Install an iron or manganese filter or water softener to home water supply.

**Rust spots on stainless steel – OR – Dark spots on flatware: stainless steel, silver plate, or sterling****Allowing salty or acidic foods such as mayonnaise, vinegar, fruit juices, salad dressings, milk products to remain on flatware**

Rinse flatware that is to stand for several hours before washing (use the Rinse & Hold Cycle). Clean stained items with silver polish and re-wash. **Do not** put stainless steel and silver flatware in the same silverware basket compartment. Direct contact between these metals can cause permanent damage to the silver.

**Undissolved detergent coming in contact with flatware**

Remove spots with silver polish. Avoid spilling concentrated detergent on wet flatware.

**Bronze tarnish on silverplate****Silverplate is worn off. Exposed base metal takes on a bronzed hue**

Remove tarnish with silver polish. Have silver replated.

**Water left in bottom of dishwasher above grate****Dishwasher cycle not completed**

Allow dishwasher to complete cycle. Some remaining water is normal and keeps seals from drying.

**Clogged drain air gap**

Some plumbing codes require use of a drain air gap between an **undercounter** dishwasher and the drain system of the house. The air gap is usually located above the sink or on the top of the counter near the dishwasher to prevent the possibility of water backing up from the drain into the dishwasher due to a plugged drain. The drain air gap is **not** a part of the dishwasher and is **not** covered by the dishwasher warranty. The drain air gap should be kept clean to ensure proper draining of the dishwasher.

# If You Need Service Or Assistance

## We suggest you follow these steps:

### 1. Before calling for assistance...

Performance problems often result from little things you can find and fix yourself without tools of any kind.

#### If your dishwasher will not run, or stops during a cycle:

- Is the door tightly closed and securely latched?
- Has the cycle been correctly set?
- Is the water turned on?
- Have you checked your home's main fuses or circuit breaker box?
- Is the dishwasher wired into a live circuit with the proper voltage?
- If the motor has stopped because of an overload, it will automatically reset itself within a few minutes. If the motor does not start, call for service.
- Is the delay feature on?

#### If your dishwasher seems to run too long:

- Is your household water temperature set too low? Low water temperature settings will cause longer dishwasher operating times.
- Are you using Pots & Pans Cycle or Hi-Temp Option? The dishwasher may be waiting for the water to heat.

#### If dishwasher won't fill:

- Is overflow protector stuck in "up" position? Overflow protector should move up and down freely. Press down to release.

#### If water remains in the dishwasher:

- Has the cycle completed?
- A small amount of remaining water is normal.
- Is drain air gap clogged?

#### If detergent remains in the covered detergent cup:

- Is the bottom rack in backwards? (The rack bumpers should be at the front.)
- Is the dishwasher detergent fresh and dry without lumps?
- Is the cycle completed?

#### If the WATER HEATING signal light flashes:

- Have you run water at the nearest sink before starting the dishwasher?
- Is water temperature at least 140°F (60°C)? Set water heater thermostat to a higher setting.

#### If signal lights flash and the dishwasher stops or will not run:

- Has there been a power failure?
- Is the cycle pause feature on? (See page 5.)
- Is the door open?

#### If control pads don't work:

- Is the lock-out feature on? (See page 6.)

#### If the beep does not sound when pads are pressed:

- Has the sound signal been turned off? (See page 6.)

#### If dishwasher drains after turning off CLEAN Signal Light and/or closing door:

- Did you accidentally press the CANCEL/DRAIN pad while closing the door? Press CANCEL/DRAIN pad again to stop draining. Restart cycle if needed.

#### If white residue appears on front of access panel:

- Is more detergent being used than needed? See page 14 for recommended amounts of detergent.
- Some liquid detergents develop excess foam and build up on exterior of access panel. Try a different brand to reduce foaming and eliminate build-up.

#### If you hear grinding, grating, crunching, buzzing sounds:

- A hard object has probably entered the POWER CLEAN™ Module. The sound should stop when the object is around up.

#### If dishes aren't as dry as you expected:

- Is the rinse agent dispenser filled? Using a rinse agent greatly improves drying. (See page 15.)

### 2. If you need assistance...

**Call Whirlpool Consumer Assistance Center telephone number. Dial free from anywhere in the U.S.:**

**1-800-253-1301**

and talk with one of our trained consultants. The consultant can instruct you in how to obtain satisfactory operation from your appliance or, if service is necessary, recommend a qualified service company in your area.

If you prefer, write to:

Mr. Donald Skinner  
Director of Consumer Relations  
Whirlpool Corporation  
2000 M-63  
Benton Harbor, MI 49022

Please include a daytime phone number in your correspondence.

**3. If you need service\*...**



Whirlpool has a nationwide network of authorized Whirlpool<sup>SM</sup> service companies. Whirlpool service technicians are trained to fulfill the product warranty

and provide after-warranty service, anywhere in the United States. To locate the authorized Whirlpool service company in your area, call our Consumer Assistance Center telephone number (see Step 2) or look in your telephone directory Yellow Pages under:

APPLIANCES - HOUSEHOLD - MAJOR - SERVICE & REPAIR      ELECTRICAL APPLIANCES - MAJOR - REPAIRING & PARTS  
 OR  
 WASHING MACHINES, DRYERS & IRONERS - SERVICING  
 WHIRLPOOL APPLIANCES AUTHORIZED WHIRLPOOL SERVICE  
 SERVICE COMPANIES  
 XYZ SERVICE CO      123 MAPLE      999-9999

**4. If you need FSP<sup>®</sup> replacement parts\*...**

FSP is a registered trademark of Whirlpool Corporation for quality parts. Look for this symbol of quality whenever you need a replacement part for your Whirlpool appliance. FSP replacement parts will fit right and work right, because they are made to the same exacting specifications used to build every new Whirlpool appliance.

To locate FSP replacement parts in your area, refer to Step 3 above or call the Whirlpool Consumer Assistance Center number in Step 2.

**5. If you are not satisfied with how the problem was solved\*...**

- Contact the Major Appliance Consumer Action Panel (MACAP). MACAP is a group of independent consumer experts that voices consumer views at the highest levels of the major appliance industry.
- Contact MACAP only when the dealer, authorized servicer or Whirlpool have failed to resolve your problem.

Major Appliance Consumer Action Panel  
 20 North Wacker Drive  
 Chicago, IL 60606

- MACAP will in turn inform us of your action.

\*When requesting assistance, please provide: model number, serial number, date of purchase, and a complete description of the problem. This information is needed in order to better respond to your request.



**POWER CLEAN™ washing system parts  
covered by your warranty**

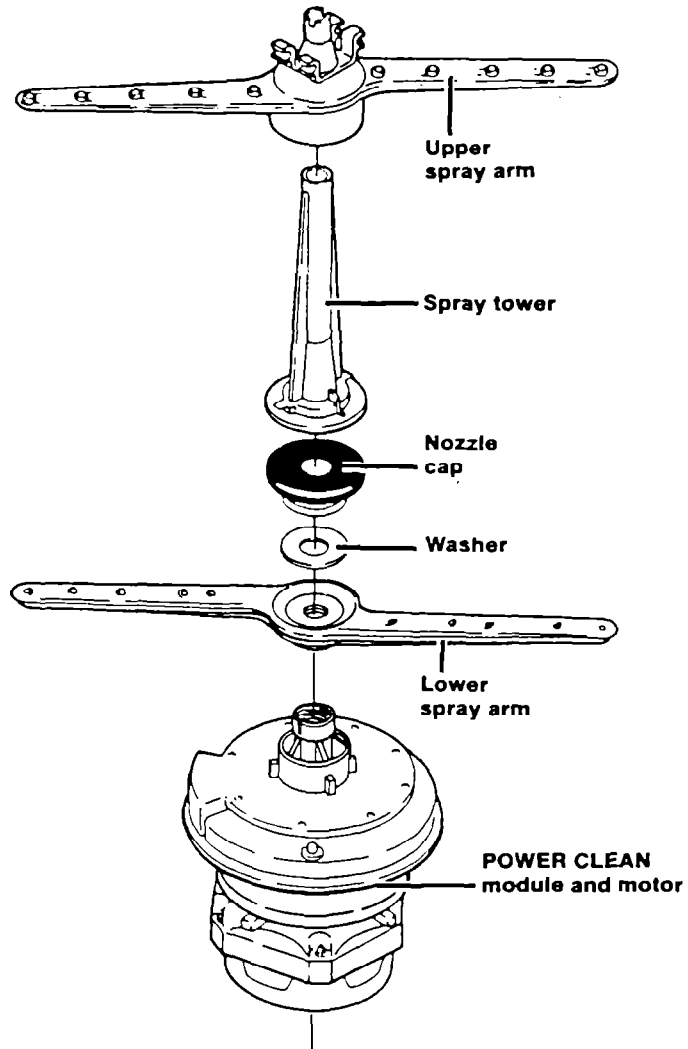

# WHIRLPOOL® Dishwasher Warranty

DW017

LENGTH OF WARRANTY	WHIRLPOOL WILL PAY FOR
<b>FULL ONE-YEAR WARRANTY</b> From Date of Purchase	FSP* replacement parts and repair labor to correct defects in materials or workmanship. Service must be provided by an authorized Whirlpool <sup>SM</sup> service company.
<b>LIMITED ONE-YEAR WARRANTY</b> Second Year From Date of Purchase	FSP replacement parts for any part of the POWER CLEAN™ Washing System if defective in materials or workmanship. These parts are shown on page 23 of this book.
<b>LIMITED FOUR-YEAR WARRANTY</b> Second through Fifth Year from Date of Purchase	FSP replacement parts for Electronic Control System if defective in materials or workmanship.
<b>LIMITED NINE-YEAR WARRANTY</b> Second Through Tenth Year From Date of Purchase	FSP replacement of the DURAPERM™ tub and/or inner door should they fail to contain water due to defective materials or workmanship.
<b>WHIRLPOOL WILL NOT PAY FOR</b>	
<p><b>A.</b> Service calls to:</p> <ol style="list-style-type: none"> <li>1. Correct the installation of the dishwasher.</li> <li>2. Instruct you how to use the dishwasher.</li> <li>3. Replace house fuses or correct house wiring or plumbing.</li> </ol> <p><b>B.</b> Repairs when dishwasher is used in other than normal, single-family household use.</p> <p><b>C.</b> Pickup and delivery. This product is designed to be repaired in the home.</p> <p><b>D.</b> Damage to dishwasher caused by accident, misuse, fire, flood, acts of God or use of products not approved by Whirlpool.</p> <p><b>E.</b> Any labor costs during limited warranties.</p> <p><b>F.</b> Repairs to parts or systems caused by unauthorized modifications made to the appliance.</p>	

WHIRLPOOL CORPORATION SHALL NOT BE LIABLE FOR INCIDENTAL OR CONSEQUENTIAL DAMAGES. Some states do not allow the exclusion or limitation of incidental or consequential damages so this limitation or exclusion may not apply to you. This warranty gives you specific legal rights, and you may also have other rights which vary from state to state.

Outside the United States, a different warranty may apply. For details, please contact your authorized Whirlpool distributor or military exchange.

If you need service, first see the "Service and Assistance" section of this book. After checking "Service and Assistance," additional help can be found by calling our Consumer Assistance Center telephone number, **1-800-253-1301**, from anywhere in the U.S.

® Registered Trademark/TM Trademark/SM Service Mark of Whirlpool Corporation

Part No. 3369100 Rev. B  
©1991 Whirlpool Corporation

Printed in U.S.A.



## Free Manuals Download Website

<http://myh66.com>

<http://usermanuals.us>

<http://www.somanuals.com>

<http://www.4manuals.cc>

<http://www.manual-lib.com>

<http://www.404manual.com>

<http://www.luxmanual.com>

<http://aubethermostatmanual.com>

Golf course search by state

<http://golfingnear.com>

Email search by domain

<http://emailbydomain.com>

Auto manuals search

<http://auto.somanuals.com>

TV manuals search

<http://tv.somanuals.com>