

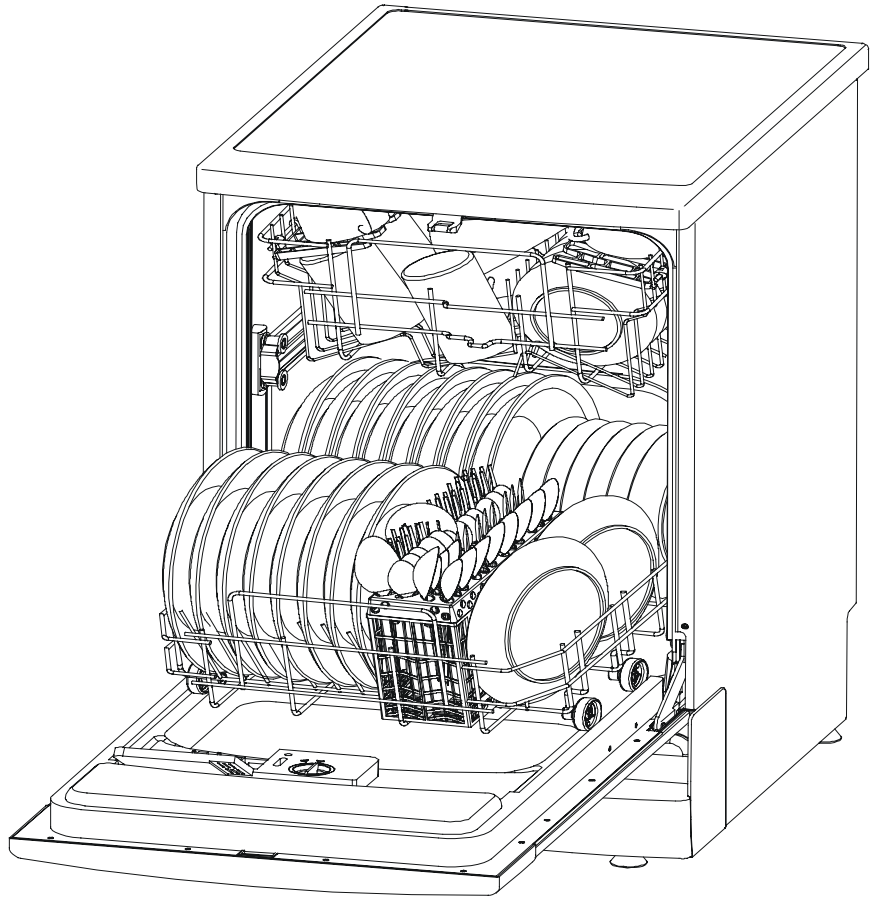

# Dishwashers

*Instruction Manual*

ADP6000WH/ADP6000IX





## *Read this Manual*

This manual contains sections of Safety Instructions, Operating Instructions, Installation Instructions and Troubleshooting Tips etc. Carefully reading it before using the dishwasher will help you to use and maintain the dishwasher properly.



## *Before Calling for Service*

To review the section on Troubleshooting Tips will help you to solve some common problems by yourself and not need to ask for the help of professional technicians.



### **NOTE:**

The manufacturer, following a policy of constant development and up-dating of the product, may make modifications without giving prior notice.

*Safety Information* ..... 1

### *Operating Instructions*

Control Panel ..... 2  
Dishwasher Features ..... 2  
Wash Cycle Table ..... 3  
Turning On the Appliance ..... 3  
Detergent ..... 4  
Rinse Aid ..... 4,5  
Loading the Dishwasher Rack ..... 5,6  
Specification of Display ..... 6  
Filtering System ..... 7  
Caring for the Dishwasher ..... 7,8

### *Installation instruction*

About Electricity connection ..... 8  
Water Connection ..... 9  
Dimensions ..... 9

### *Troubleshooting Tips*

Before calling for service ..... 10,11

# IMPORTANT SAFETY INFORMATION

## READ ALL INSTRUCTIONS BEFORE USING

### **WARNING!**

When using your dishwasher, follow the below basic precautions including the following:



### **WARNING! HYDROGEN GAS IS EXPLOSIVE**

Under certain conditions, Hydrogen gas may be produced in a hot-water system that has not been used for two weeks or more. HYDROGEN GAS IS EXPLOSIVE. If the hot-water system has not been used for such a period, before using the dishwasher turn on all hot-water faucets and let the water flow from each for several minutes. This will release any accumulated hydrogen gas. As the gas is flammable, do not smoke or use an open flame during this time.



### **DISPOSAL**

Do not dispose this product as unsorted municipal waste. Collection of such waste separately for special treatment is necessary.



### **GROUNDING INSTRUCTIONS**

- This appliance must be grounded. In the event of a malfunction or breakdown, grounding will reduce the risk of electric shock by providing a path of least resistance of electric current. This appliance is equipped with a cord having an equipment-grounding conductor and a grounding plug. The plug must be plugged into an appropriate outlet that is installed and grounded in accordance with all local codes and ordinances.

### **WARNING!**

- Improper connection of the equipment-grounding conductor can result in a risk of electric shock. Check with a qualified electrician or service representative if you are in doubt whether the appliance is properly grounded. Do not modify the plug provided with the appliance; If it is not fit for the outlet. Have a proper outlet installed by a qualified electrician.



### **WARNING! PROPER USE**

- Do not abuse, sit on, or stand on the door or dish rack of the dishwasher.
- Do not touch the heating element during or immediately after use.
- Do not operate your dishwasher unless all enclosure panels are properly in place. Open the door very carefully if the dishwasher is operating, there is a risk of water squirting out.
- Do not place any heavy objects or stand on the door when it is open. The appliance could tip forward.
- When loading items to be washed:
  - 1) Locate sharp items so that they are not likely to damage the door seal;
  - 2) Load sharp knives with the handles up to reduce the risk of cut-type injuries.
  - 3) Warning: Knives and other utensils with sharp points must be loaded in the basket with their points down or placed in a horizontal position.
- When using your dishwasher, you should prevent plastic item from contacting with heating element.
- Check that the detergent receptacle is empty after completion of the wash cycle.
- Do not wash plastic items unless they are marked dishwasher safe or the equivalent. For plastic items not so marked, check the manufacturer's recommendations.
- Use only detergent and rinse additives designed for an automatic dishwasher. Never use soap, laundry detergent, or hand washing detergent in your dishwasher. Keep these products out of the reach of children.
- Other means for disconnection from the supply must be incorporated in the fixed wiring with at least 3mm contact separation in all poles.
- Keep children away from detergent and rinse aid, keep children away from the open door of the dishwasher, there could still be some detergent left inside.
- Young children should be supervised to ensure that they do not play with the appliance.
- The appliance is not intended for use by young children or infirm persons without supervision.
- Dishwasher detergents are strongly alkaline, they can be extremely dangerous if swallowed. Avoid contact with skin and eyes and keep children away from the dishwasher when the door is open.
- The door should not be left in the open position since this could present a tripping hazards.
- If the supply cord is damaged, it must be replaced by the manufacturer or its service agent or a similarly qualified person in order to avoid a hazard.
- Remove the door to the washing compartment when removing an old dishwasher from service or discarding it.
- Please dispose of packing materials properly. Use the dishwasher only for its intended function.
- During installation, the power supply must not be excessively or dangerously bent or flattened.
- Do not tamper with controls.
- The appliance is to be connected to the water mains using new hose sets and that old hose-sets should not be reused.
- The maximum number of place settings to be washed is 12.
- The maximum permissible inlet water pressure is 1Mpa.
- The minimum permissible inlet water pressure is 0.04Mpa.

**READ AND FOLLOW THIS SAFETY INFORMATION CAREFULLY**

**SAVE THESE INSTRUCTIONS**

## IMPORTANT!

To get the best performance from your dishwasher, read all operating instructions before using it for the first time.

### Control Panel

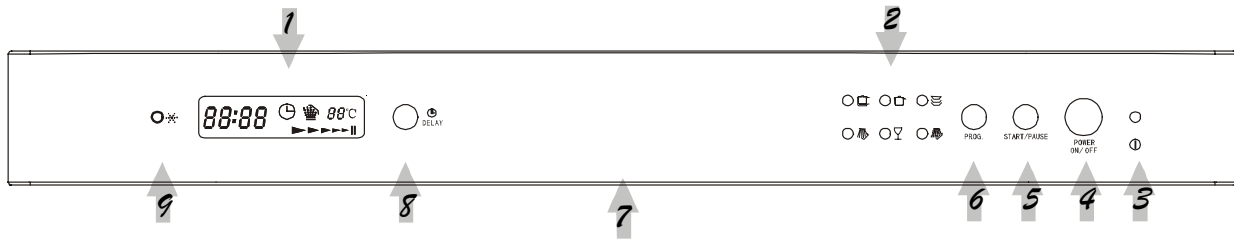





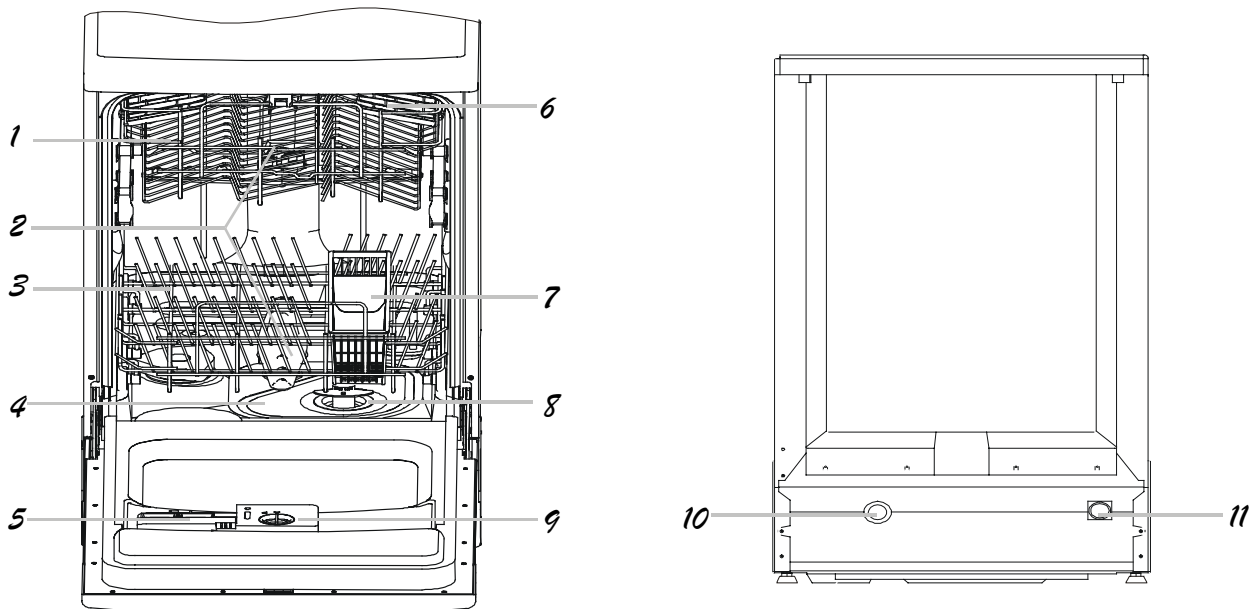

- 1** Display Window: Program remaining time, delay time, running indicator, temperature of water, fault codes and etc.
- 2** Program indicator light: when you select a program, the corresponding indicator light will be on.
- 3** Power On Indicator Light: Comes on when the power is turned on.
- 4** Power Switch: Turn on/off the power supply.
- 5** Start / Pause button: Press this button to start or pause the dishwasher.
- 6** Program button: Press the button to choose the desired program.
- 7** Door Lock: Pull it to open the door.
- 8** Delayed Start Button: Press this button to set the delayed hours for washing. You can delay the start of washing up to 12 hours. One press on this button delays the start of washing by half an hour.
- 9** Rinse Aid Warning Light: To come on when rinse aid dispenser needs to be refilled.

### Dishwasher Features



- |                       |                              |                              |                                |
|-----------------------|------------------------------|------------------------------|--------------------------------|
| <b>1</b> Upper Basket | <b>4</b> Main Filter         | <b>7</b> Silverware Basket   | <b>10</b> Drain pipe connector |
| <b>2</b> Spray Arms   | <b>5</b> Detergent Dispenser | <b>8</b> Coarse Filter       | <b>11</b> Inlet pipe connector |
| <b>3</b> Lower Basket | <b>6</b> Cup Shelf           | <b>9</b> Rinse Aid Dispenser |                                |

## Wash Cycle Table

Program	Cycle	Cycle Selection Information	Description of Cycle	Detergent pre/main	Rinse Aid
Strong		For the heaviest soiled loads, such as pots, pans, casserole dishes and dishes that have been sitting with dried food on them for a while.	Pre-wash Pre-wash 50°C wash 60°C Rinse 70°C.	5/22 g.	★
Normal	 (IEC-EN 50242)	For normally soiled loads, such as pots, plates, glasses and lightly soiled pans. standard daily cycle.	Pre-wash Pre-wash wash 50°C Rinse 70°C.	5/25 g.	★
Economy		For lightly soiled loads, such as plates, glasses, bowls and lightly soiled pans.	Pre-wash wash 45°C Rinse 60°C.	22 g.	★
Rinse		For dishes that need to be rinsed and dried only	Wash 45°C Rinse 70°C		★
Glass		A shorter wash for lightly soiled loads that do not need drying.	Pre-wash wash 40°C Rinse 70°C	15 g.	
Soak		Pre-wash of dishes pots and pans while waiting for the load to be completed after the subsequent meal.	Pre-wash		

## Turning on the Appliance

### Starting a wash cycle. . .

- 1 Draw out the lower and upper baskets, load the dishwares and push them back. It is commended that loading the lower basket first, then the upper one. The expensive and finer chinaware should not be put in.
- 2 With a little force to ensure the door is properly closed.  
**Note:** a sound of click could be heard when the door is closed perfectly.
- 3 Insert the plug into the socket.  
The power supply is 220–240V 50HZ, the specification of the socket is 250V 12A.
- 4 Turn on the water supply to full pressure
- 5 Press the ON/OFF button
- 6 According to the soil level to choose the desired program by pressing program selection button.
- 7 Press start/pause button to start a washing.

### Change the Programme

**NOTE:** A programme can be changed only before the detergent has been released. Otherwise, you must refill the detergent dispenser.

Turn off the appliance to cancel the current programme. (the current programme can be always cancelled by this way)

Then turn on the appliance and press the programme button to select the desired programme.

Press the start button to start washing.



### At the end of the wash cycle

The alarm will sound for 8 seconds.

Open the door of your dishwasher and switch your dishwasher off using the on/off key.

Wait a few minutes before unloading the dishwasher to avoid handling the dishes and utensils while they are still hot and more susceptible to breakage.

# DETERGENT DISPENSER

The dispenser must be refilled before the start of each wash cycle following the instructions provided in the "Wash Cycle Table". Your dishwashers use less detergent and rinse aid than conventional dishwashers. Generally, only one tablespoon of detergent is needed for a normal wash load. Also, more heavily soiled items need more detergent. Always add the detergent just before starting dishwasher, otherwise it could get damp and will not dissolve properly.

## Amount of Detergent to Use

IF THE WATER ISN'T TOO HARD, YOU MAY ALSO PREVENT THE FORMATION OF DEPOSITS BY ADDING DETERGENT. The amount of detergent needed can vary due to differences in water hardness. To determine the water hardness in your area, contact your local water utility or area water softening company. The harder the water, the more detergent you may need. Remember, you should adjust the amount of detergent you use by small amounts until you find the correct amount.

**THE NORMAL DOSAGE PLEASE REFERENCE TO THE SECTION ENTITLED "WASH CYCLE TABLE"**

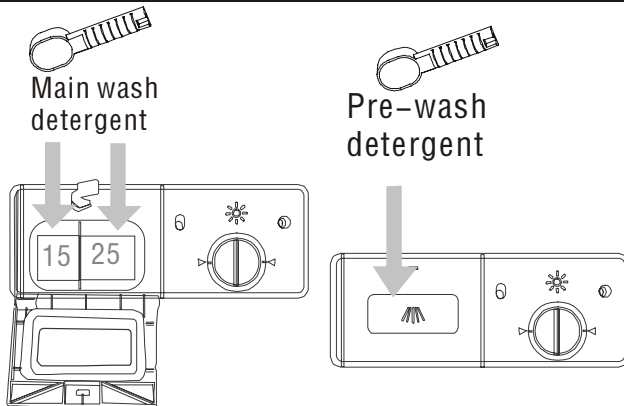

### ⚠ WARNING!

Dishwasher detergent is corrosive! Take care to keep it out of reach of children.

## Removing Hard Water Spots

To remove hard water spots, try the following:

- Run dishes through a normal wash program.
- Remove all metal dishware, such as cutlery, pans, etc., from the dishwasher.
- Do not add detergent.
- Pour two cups of vinegar into a bowl and set the bowl face up on the lower rack of the dishwasher.
- Run the dishes through a normal wash program.

If this doesn't work, try the same process with 1 / 4 cup of citric acid crystals instead of vinegar.

## Proper Use of Detergent

Use only detergent specifically made for use in dishwashers. Keep your detergent fresh and dry. Don't put powder detergent into the dispenser until you're ready to wash dishes.

# RINSE AID DISPENSER

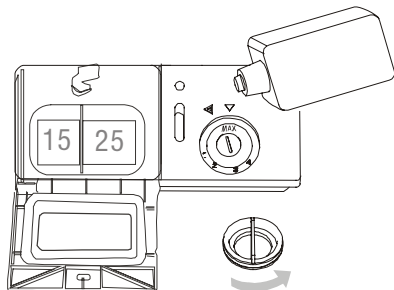

- To open the dispenser, turn the cap to the "open" (left) arrow and lift it out.
- Pour the rinse aid into the dispenser, being careful not to overfill.
- Replace the cap by inserting it aligned with "open" arrow and turning it to the closed (right) arrow.

The rinse aid is released during the final rinse to prevent water from forming droplets on your dishes that can leave spots and streaks. It also improves drying by allowing water to "sheet" off the dishes.

Your dishwashers are designed to use liquid rinse aids. The rinse aid dispenser is located inside the door next to the detergent dispenser. To fill the dispenser, open the cap and pour the rinse aid into the dispenser until the level indicator turns completely black. The volume of the rinse aid container is about 140ml.

Be careful not to overfill the dispenser, because this could cause oversudsing. Wipe away any spills with a damp cloth. Don't forget to replace the cap before you close the dishwasher door.

If you have soft water, you may not need rinse aid for it may cause a white film to develop on your dishes.

## Adjusting Rinse Aid Dispenser

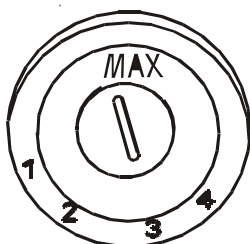

A measured amount of rinse aid is released during the final rinse. As with detergent, the amount of rinse aid needed for your dishes depends on the hardness of the water in your area. Too much rinse aid can result in lather of foaming and cause cloudiness or streaks on your dishes. If the water in your area is very soft, you may not need rinse aid. If you do, you can dilute the rinse aid with an equal amount of water.

The rinse aid dispenser has four settings. Always start with the dispenser set on "1". If spots and poor drying are problems, increase the amount of rinse aid dispensed by removing the dispenser lid and rotating the dial to "2". If the dishes still are not drying properly or are spotted, adjust the dial to the next higher number until your dishes are spot-free. We suggest you to set on "3".

## When to Refill the Rinse Aid Dispenser

If there is no rinse aid warning light in the control panel, you can judge the amount of rinse aid by the following means. The black dot on the rinse aid dispenser indicates the amount of rinse aid in the dispenser. As the rinse aid diminishes, the size of the black dot decreases. You should never let the rinse aid get below 1 / 4 full.

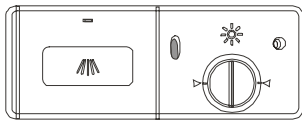

As the rinse aid diminishes, the size of the black dot on the rinse aid level indicator changes, as illustrated below.

- Full
- 3 / 4 full
- 1 / 2 full
- 1 / 4 full – Should refill to eliminate spotting
- Empty

## Loading the Dishwasher Racks.

For best performance of the dishwasher, follow these loading guidelines. Features and appearance of racks and silverware baskets may vary from your model.

### How to use the Upper Rack

The upper rack is designed to hold more delicate and lighter dishware such as glasses, coffee and tea cup and saucers, as well as plates, small bowls and shallow pans (as long as they are not too dirty).

Position the dishes and cookware so that they do not get moved by the spray of water.

The upper rack can be adjusted for height by putting wheels of different height into the rails.

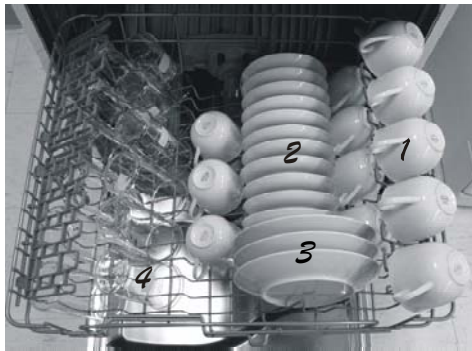

- 1 Cups
- 2 Saucers
- 3 Dessert dishes
- 4 Glasses

### How to use the Lower Rack

We recommend that you place large items which are most difficult to clean into the lower rack: pots, pans, lids, serving dishes and bowls, as shown in the figure to the right.

It is preferable to place serving dishes and lids on the side of the racks in order to avoid blocking the rotation of the top spray arm.

- Pots, serving bowls, etc, must always be placed top down.
- Deep pots should be slanted to allow water to flow out.
- The bottom rack feature fold down tine rows so that larger or more pots and pans can be loaded.

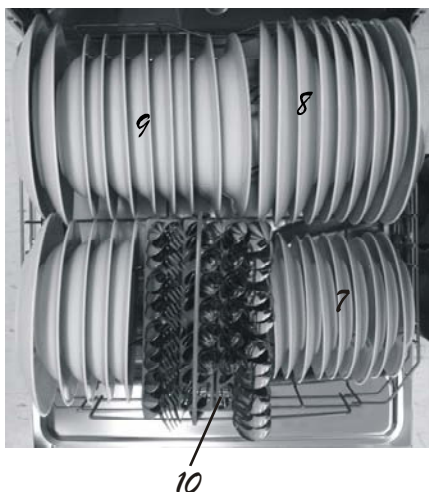

- 7 Dessert dishes
- 8 Dinner plates
- 9 Soup plates
- 10 Silverware basket

# SILVERWARE BASKET

Silverware should be placed in the silverware basket with handles at the bottom: If the rack has side baskets, the spoon should be loaded individually into the appropriate slots, Especially long utensils should be placed in the horizontal position at the front of the upper rack.

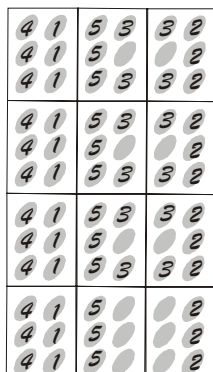
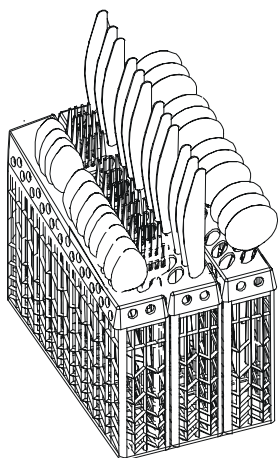

- 1 Forks
- 2 Soup spoons
- 3 Dessert spoons
- 4 Teaspoons
- 5 Knife



**▲ WARNING!**

Do not let any item extend through bottom.

## Specification of Display

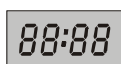

Digital sign: Display the delayed time, remaining time and fault codes.



Delay sign: Display the sign when delaying.



Wash sign: Display the sign when washing.



Running sign: Repeatedly display the sign in turn when running, no flicker when stopping.



Temperature display: Display the wash temperature at any time.

## Fault codes

Codes	Meanings	Possible Causes
Err1	Longer inlet time.	Faucets is not opened.
Err2	Longer draining time.	The installation position of the drain pipe is too high.
Err3	Longer heating time, but not reaching required temperature	Malfunction of temperature sensor or of heating element.
Err4	Overfilled.	Too much inlet water. .
Err6,Err7	Abnormal temperature	Short circuit or break of temperature sensor.



## Filtering System

For your convenience, we have placed the drain pump and filtering system within easy reach inside the tub. There are three components of the filtering system: the main filter, the coarse filter, and the fine filter.

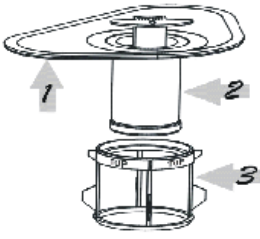

- 1 Main filter**  
Food and soil particles trapped by this filter are pulverized by a special jet on the lower spray arm and washed down the drain.
- 2 Coarse filter**  
Larger items, such as pieces of bone or glass, that could clog the drain are trapped in the coarse filter. To remove an item caught in this filter, gently squeeze the tabs on top of this filter and lift it out.
- 3 Fine filter**  
This filter holds soil and food residue in the sump area and prevents it from being redeposited on the dishes during a cycle.

ATTENTION: Do not put the fine filter upside down.

## Caring for the Dishwasher

To clean the control panel use a lightly dampened cloth then dry thoroughly. To clean the exterior use a good appliance polish wax.

Never use sharp objects, scouring pads or harsh cleaners on any part of the dishwasher.

## Protect Against Freezing

If your dishwasher is left in an unheated place during the winter, ask a service technician to:

- 1** Cut off electrical power to the dishwasher.
- 2** Turn off the water supply and disconnect the water inlet pipe from the water valve.
- 3** Drain water from the inlet pipe and water valve.  
(Use a pan to catch the water.)
- 4** Reconnect the water inlet pipe to the water valve.
- 5** Remove the filter in the tub the bottom and use a sponge to soak up water in sump.

## Cleaning the Spray Arms

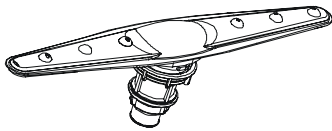

It is necessary to clean the spray arms regularly for hard water chemicals will clog the spray arm jets and bearings. To remove the spray arm, screw off the nut to take out the washer on top of the spray arm and remove the arm. Wash the arms in soapy and warm water and use a soft brush to clean the jets. Replace them after rinsing them thoroughly.

## Cleaning the Filters

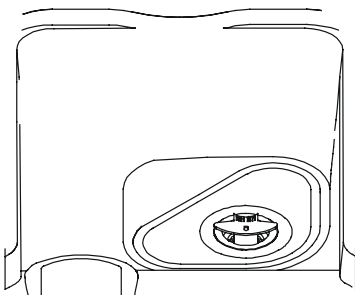

### Filter assembly

For best performance and results, the filter assembly must be cleaned.

The filter efficiently removes food particles from the wash water, allowing it to be recirculated during the cycle. For this reason, it is a good idea to remove the larger food particles trapped in the filter after each wash cycle by rinsing the semicircular filter and cup under running water. To remove the filter assembly, pull on the cup handle in the upward direction. The entire filter assembly should be cleaned once a week.

To clean the coarse filter and the fine filter, use a cleaning brush. Then, reassemble the filter parts as shown in the figures left and reinsert the entire assembly in the dishwasher, positioning in its seat and pressing downward.

The dishwasher must never be used without the filters. Improper replacement of the filter may reduce the performance level of the appliance and damage dishes and utensils.

### **▲ WARNING!**

Never run the dishwasher without the filters in place.

## Cleaning the Door

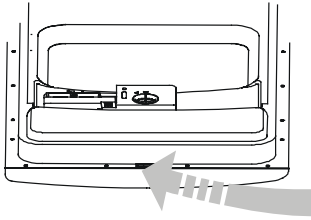

To clean the edge around the door, you should use only a soft warm, damp rag. To prevent penetration of water into the door lock and electrical components, do not use a spray cleaner of any kind.

Also, never use abrasive cleaners or scouring pads on the outer surfaces because they will scratch the finish. Some papers towels can also scratch or leave marks on the surface.

### **▲ WARNING!**

Never use a spray cleaner to clean the door panel for it could damage the door lock and electrical components. It is not allowed to use the abrasive agent or some paper towel because of the risk of scratching or leaving spots on the stainless steel surface.

## How to Keep Your Dishwasher in Shape

### ■ *After Every Wash*

After every wash, turn off the water supply to the appliance and leave the door slightly ajar so that moisture and odors are not trapped inside.

### ■ *Remove the Plug*

Before cleaning or performing maintenance, always remove the plug from the socket. Do not run risks.

### ■ *No Solvents or Abrasive Cleaning*

To clean the exterior and rubber parts of the dishwasher, do not use solvents or abrasive cleaning products. Rather, use only a cloth and warm soapy water. To remove spots or stains from the surface of the interior, use a cloth dampened with water and a little white vinegar, or a cleaning product made specifically for dishwashers.

### ■ *When You Go on Holiday*

When you go on holiday, it is recommended that you run a wash cycle with the dishwasher empty and then remove the plug from the socket, turn off the water supply and leave the door of the appliance slightly ajar. This will help the seals last longer and prevent odors from forming within the appliance.

### ■ *Moving the Appliance*

If the appliance must be moved, try to keep it in the vertical position. If absolutely necessary, it can be positioned on its back.

### ■ *Seals*

One of the factors that cause odors to form in the dishwasher is food that remains trapped in the seals. Periodic cleaning with a damp sponge will prevent this from occurring.

## About Electricity Connecting

### **▲ CAUTION, for personal safety:**

**DO NOT USE AN EXTENSION CORD OR AN ADAPTER PLUG WITH THIS APPLIANCE.**

**DO NOT, UNDER ANY CIRCUMSTANCES, CUT OR REMOVE THE THIRD GROUNDING PRONG FROM THE POWER CORD.**

## Electrical Requirements

Please see the rating label to know the rating voltage and connect the dishwasher to appropriate power supply. Use required fuse 12 amp. Fused electrical supply is required—copper wire only. Time delay fuse or circuit breaker recommended and provide separate circuit serving only this appliance. Outlet should be placed in adjacent cabinet.

## Electrical Connection

After making sure that the voltage and the frequency values for the current in the home correspond to those on the rating plate and that the electrical system is sized for the maximum voltage on the rating plate, insert the plug into an electrical socket which is earthed properly. If the electrical socket to which the appliance must be connected is not appropriate for the plug, replace the socket, rather than using a adaptor or the like as they could cause overheating and burns.

**▲ Insure proper ground exists before use**

## Cold Water Connection

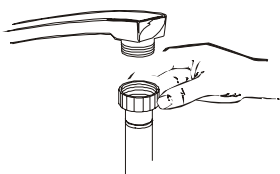

Connect the cold water supply hose to a threaded 3/4(inch) connector and make sure that it is fastened tightly in place.

If the water pipes are new or have not been used for an extended period of time, let the water run to make sure that the water is clear and free of impurities. If this precaution is not taken, there is a risk that the water inlet can get blocked and damage the appliance.

## Hot Water Connection

The water supply to the appliance can also be connected to the house hot water line (centralized system, heating system), as long as it does not exceed a temperature of 60°C. In this case, the wash cycle time will be shortened by about 15 minutes and the wash efficiency slightly reduced.

The connection must be made to the hot water line following the same procedures as those for the connection to the cold water line.

## Positioning the Appliance

Position the appliance in the desired location. The back should rest against the wall behind it, and the sides, along the adjacent cabinets or wall. The dishwasher is equipped with water supply and drain hoses that can be positioned to the right or the left to facilitate proper installation.

## Levelling the Appliance

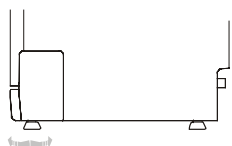

Once the appliance is positioned, adjust the feet (screwing them in or out) to adjust the height of the dishwasher, making it level. In any case, the appliance should not be inclined more than 2°.

## Drain hose Connection

Insert the drain hose into a drain pipe with a minimum diameter of 40 mm, or let it run into the sink, making sure to avoid bending or crimping it. Use the special plastic support that comes with the appliance. The free end of the hose must be at a height between 400 and 1000mm and must not be immersed in water.

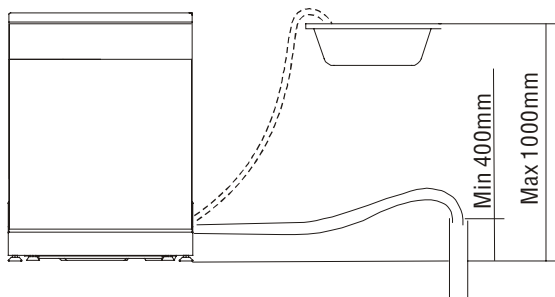

## How to Drain Excess Water From Hoses

If the sink is 1000 higher from the floor, the excess water in hoses cannot be drained directly into the sink. It will be necessary to drain excess water from hoses into a bowl or suitable container that is held outside and lower than the sink.

## DIMENSIONS(mm)

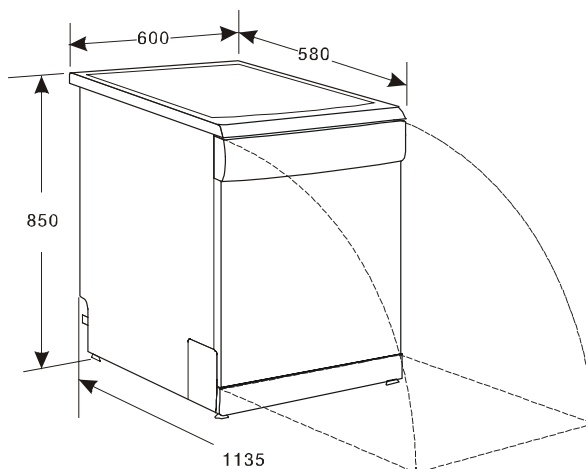

### ⚠ WARNING!

In order to avoid that there is more water staying in the inlet hose, please close the hydrant after using. (For the models: no safety inlet hose.)



**appliancesonline**  
.com.au

Australia's largest online appliance retailer

## Before Calling for service . . .

### Troubleshooting Tips

Review the charts on the following pages may make you be free of calling for service.



<i>Problem</i>	<i>Possible Causes</i>	<i>What To Do</i>
<i>Dishwasher doesn't run</i>	Fuse blown, or the circuit breaker acted	Replace fuse or reset circuit breaker. Remove any other appliances sharing the same circuit with the dishwasher
	Power supply is not turned on	Make sure the dishwasher is turned on and the door is closed securely. Make sure the power cord is properly plugged into the wall socket.
	Water pressure is low	Check that the water supply is connected properly and the water is turned on.
<i>Drain pump doesn't stop</i>	Overflow	The system is designed to detect an overflow. When it does, it shuts off the circulation pump and turns on the drain pump.
<i>Noise</i>	Some audible sounds are normal	Sound from soft food shredding action and detergent cup opening.
	Utensils are not secure in the baskets or something small has dropped into the basket	To ensure everything is secured in the dishwasher.
	Motor hums	Dishwasher has not been used regularly. If you do not use it often, remember to set it to fill and pump out every week, which will help keep the seal moist.
<i>Suds in the tub</i>	Improper detergent	Use only the special dishwasher detergent to avoid suds.  If this occurs, open the dishwasher and let suds evaporate.  Add 1 gallon of cold water to the tub. Close and latch the dishwasher, then drain out the water by slowly turning the Dial until a drain period is reached. Repeat if necessary.
	Spilled rinse agent	Always wipe up rinse agent spills immediately.
<i>Stained tub interior</i>	Detergent with colorant was used	Make sure that the detergent is the one without colorant.
<i>Dishes are not dried</i>	Rinse agent dispenser is empty	Make sure that the rinse agent dispense is filled.
<i>Dishes and flatware not clean</i>	Improper program	Select stronger program
	Improper rack loading	Make sure that the action of the detergent dispenser and spray arms are not blocked by large dishware.
<i>Spots and filming on glasses and flatware</i>	<ul style="list-style-type: none"> <li>1 Extremely hard water</li> <li>2 Low inlet temperature</li> <li>3 Overloading the dishwasher</li> <li>4 Improper loading</li> <li>5 Old or damp powder detergent</li> <li>6 Empty rinse agent dispenser</li> <li>7 Incorrect dosage of detergent</li> </ul>	<ul style="list-style-type: none"> <li>• To remove spots from glassware:               <ul style="list-style-type: none"> <li>1 Take out all metal utensils out of the dishwasher.</li> <li>2 Do not add detergent.</li> <li>3 Choose the longest cycle.</li> <li>4 Start the dishwasher and allow it to run for about 18 to 22 minutes, then it will be in the main wash.</li> <li>5 Open the door to pour 2 cups of white vinegar into the bottom of the dishwasher.</li> <li>6 Close the door and let the dishwasher complete the cycle. If the vinegar does not work: Repeat as above, except use 1/4 cup (60 ml) of citric acid crystals instead of vinegar.</li> </ul> </li> </ul>

## Before calling for service . . .

<i>Problem</i>	<i>Possible Causes</i>	<i>What To Do</i>
<i>Cloudiness on glassware</i>	Combination of soft water and too much detergent	Use less detergent if you have soft water and select a shortest cycle to wash the glassware and to get them clean.
<i>Yellow or brown film on inside surfaces</i>	Tea or coffee stains	using a solution of 1/2 cup of bleach and 3 cups warm water to remove the stains by hand. <b>▲ WARNING</b> You have to wait for 20 minutes after a cycle to let the heating elements cool down before cleaning interior; otherwise, burns will happen.
	Iron deposits in water can cause an overall film	You have to call a water softener company for a special filter.
<i>White film on inside surface</i>	Hard water minerals	To clean the interior, use a damp sponge with dishwasher detergent and wear rubber gloves. Never use any other cleaner than dishwasher detergent for the risk of foaming or suds.
<i>Detergent cup lid won't latch</i>	Dial is not in the OFF position	Turn the Dial to OFF position and slide the door latch to the left.
<i>Detergent left in dispenser cups</i>	Dishes block detergent cups	Re-loading the dishes properly.
<i>Steam</i>	Normal phenomenon	There is some steam coming through the vent by the door latch during drying and water draining.
<i>Black or gray marks on dishes</i>	Aluminum utensils have rubbed against dishes	Use a mild abrasive cleaner to eliminate those marks.
<i>Water standing in the bottom of the tub</i>	This is normal	A small amount of clean water around the outlet on the tub bottom at the back of the tub keeps the water seal lubricated.
<i>Dishwasher leaks</i>	Overfill dispenser or rinse aid spills	Be careful not to overfill the rinse aid dispenser. Spilled rinse aid could cause oversudsing and lead to overflowing. Wipe away any spills with a damp cloth.
	Dishwasher isn't level	Make sure the dishwasher is level.

## Free Manuals Download Website

<http://myh66.com>

<http://usermanuals.us>

<http://www.somanuals.com>

<http://www.4manuals.cc>

<http://www.manual-lib.com>

<http://www.404manual.com>

<http://www.luxmanual.com>

<http://aubethermostatmanual.com>

Golf course search by state

<http://golfingnear.com>

Email search by domain

<http://emailbydomain.com>

Auto manuals search

<http://auto.somanuals.com>

TV manuals search

<http://tv.somanuals.com>