

use & care guide

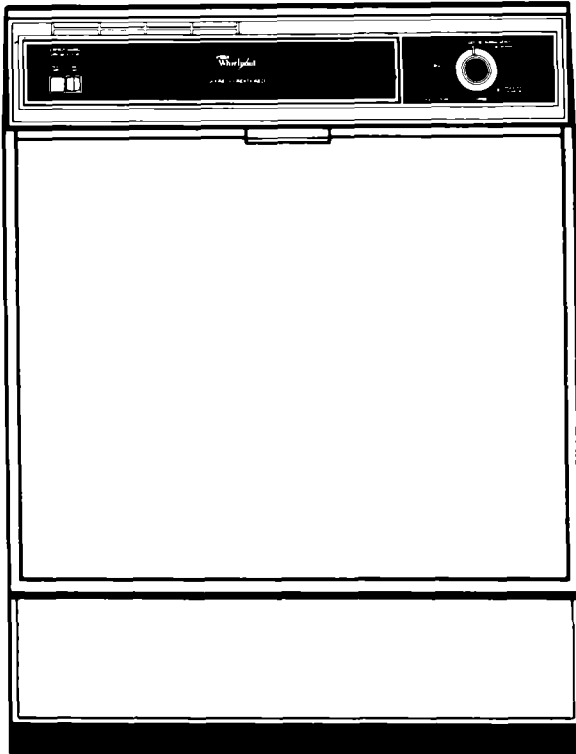

Convertible Portable Dishwasher

Model DP3880XM

rs, Freezers, Refrigerator-Freezers, Ice Makers, Dishwashers, Built-In Ovens and Surface Units, Ranges, Microwave Ovens, Trash Compactors, Room Air Conditioners, Dehumidif

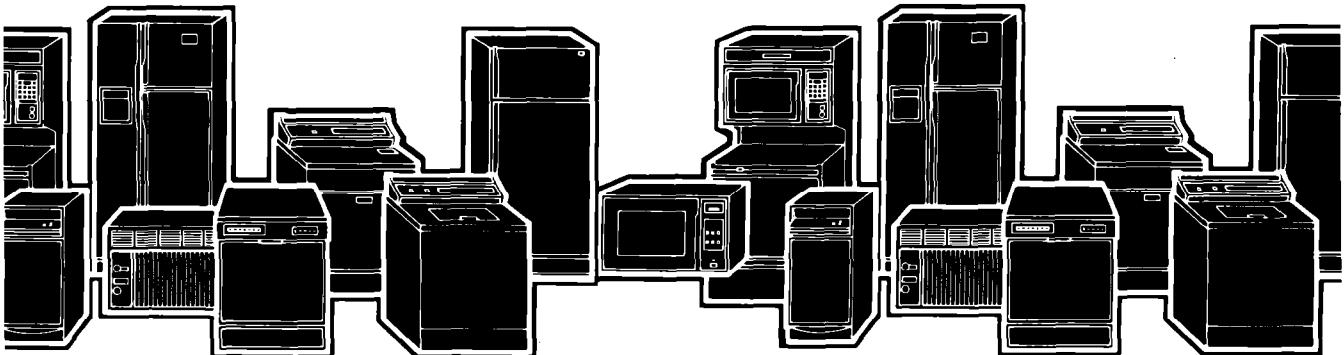

Contents

	Page		Page
BEFORE YOU USE YOUR DISHWASHER	2	Selecting a Cycle	9
IMPORTANT SAFETY INSTRUCTIONS	2	HEAT DRY or AIR DRY?	9
PARTS AND FEATURES	3	To Add a Dish After Starting	9
FOR BEST RESULTS	4	CONNECTING YOUR PORTABLE	
The Filtering System	4	DISHWASHER	10
PROPER LOADING	5	ENERGY SAVING TIPS	11
Top Rack Loading	5	COMMON DISHWASHING PROBLEMS	12
Bottom Rack Loading	6	SPECIAL TIPS	14
Silverware Basket Loading	6	IF YOU NEED SERVICE OR ASSISTANCE	15
ADDING DETERGENT	7	1. Before Calling for Assistance	15
BEFORE STARTING YOUR DISHWASHER	8	2. If You Need Assistance	15
STARTING YOUR DISHWASHER	8	3. If You Need Service	15
Changing a Setting	8	4. If You Have a Problem	15

©1984 Whirlpool Corporation

Before you use your dishwasher



It is your personal responsibility and obligation to be sure your dishwasher:

- Is installed by a qualified installer.
- Has been installed where it is protected from the elements.
- Has been installed on a floor strong enough to support its weight.
- Has been properly connected to electricity, water and drain.*
- Has been properly electrically grounded.*
- Is not used by children or anyone unable to operate it properly.
- Is properly maintained.

*See installation instructions for complete information.

Important safety instructions



WARNING – When using your dishwasher, follow basic precautions, including the following:

1. Read all instructions before using the dishwasher.
2. **DO NOT** let children play in or on the dishwasher.
3. **DO NOT** try to remove or clean Pump Guard portion of the filter until the heating element in the bottom of the dishwasher has cooled for at least 20 minutes.
4. **DO NOT** wash plastic items unless marked "Dishwasher Safe" or the equivalent. If not marked check manufacturer's recommendations.
5. Store dishwasher detergent in a cool, dry place **WHERE CHILDREN CAN'T REACH IT**.
6. Use **ONLY** detergents and rinse aids recommended for use in a dishwasher.
7. **REMEMBER**, use your dishwasher only for the job it was designed to do.
8. Locate sharp items and knives so that they are not likely to damage door seal or cut the user.
9. Properly connect to electricity and water.
10. **DISHWASHER MUST BE ELECTRICALLY GROUNDED.** Read the Installation Instructions for details.
11. **DO NOT** use your dishwasher unless all enclosure panels are properly in place.
12. Be sure your dishwasher is installed on a level floor that will hold the weight, and in an area suitable for its size and use.
13. **DO NOT** sit or stand on or abuse the dishwasher door or dish racks.
14. **DO NOT** tamper with controls.
15. When discarding an old dishwasher, always remove the door to prevent accidental entrapment.
16. **WARNING:** If hot water has not been used recently (usually two weeks or longer), hydrogen gases may build up in the water heater and the hot water pipes. **HYDROGEN GAS IS EXPLOSIVE.** To prevent injury or damage, before using your dishwasher, turn on all hot water faucets and allow water to run for several minutes. This will allow gases to escape. Do not smoke or use any open flame near the faucet while it is open.
17. Always disconnect electrical power to the dishwasher before attempting to service.

– SAVE THESE INSTRUCTIONS –

Parts and features

Model DP3880XM

NUMBER PLATE
MODEL AND SERIAL
(not shown)

UPPER SPRAY ARM

TOP RACK

WATER
COLUMN

LOWER SPRAY ARM

SILVERWARE BASKET

RACK BUMPER

BOTTOM RACK

DETERGENT
DISPENSERS

USER GUIDE
(Permanent Label)

HEATING ELEMENT

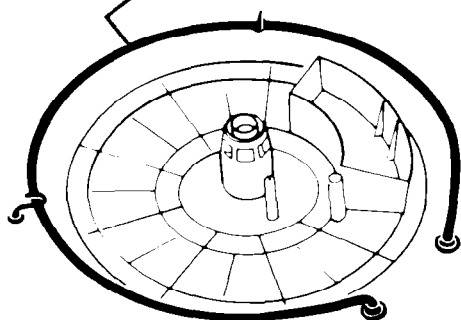

FILTER SYSTEM
(Screen and Removable
Pump Guard)

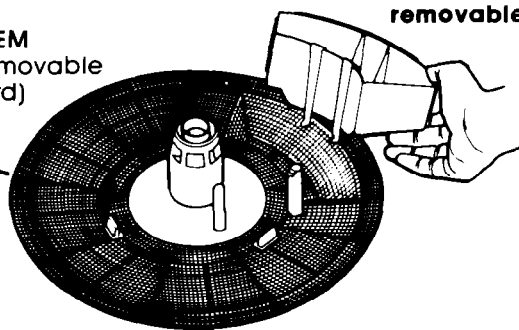

THE OVERFLOW
PROTECTOR is
designed to prevent
too much water
from entering the
dishwasher. It is not
removable.

Copy your Model and Serial Numbers here...

When you need service or call with a question, have this information ready:

1. **Complete** Model and Serial Numbers (from the plate located as shown).

2. Purchase date from sales slip.

Copy this information in these spaces. Keep this book, your warranty and sales slip together in a handy place. There is no warranty registration to return. Proof-of-purchase is all that is required for in-warranty service.

Model Number

Serial Number

Purchase Date

Service Company and Telephone Number

For Best Results

Your dishwasher cleans by spraying a mixture of hot, clean water and detergent against soiled surfaces of dishes. When a cycle is started, the dishwasher fills with water to about the level of the heating element. This water is pumped through the rotating spray arms, drained through the filter system which removes food and soil, and pumped back through the rotating spray arms. Soiled water is pumped out and replaced with clean water during a cycle – the number of times depends on the cycle being used.

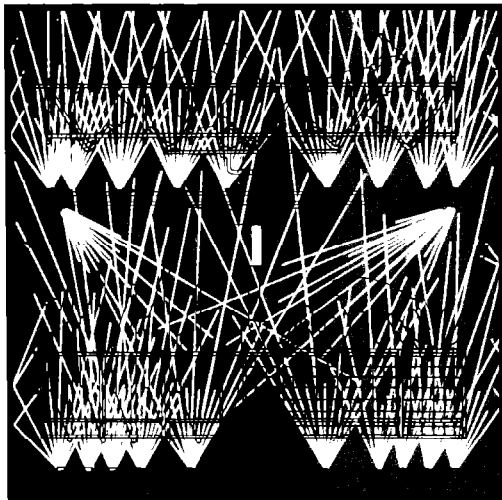

Load dishes so soiled surfaces face powerful spray from rotating arms.

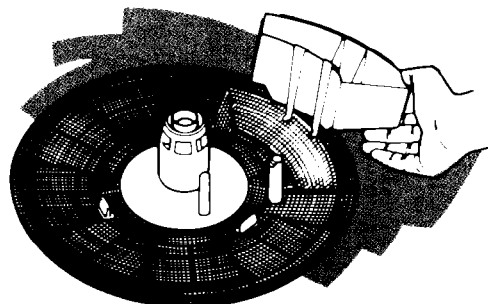

The self-cleaning filtering system and removable pump guard help eliminate pre-rinsing by removing food particles from the water.

The filtering system

It is not necessary to rinse dishes before putting them into the dishwasher. Just remove large pieces and quantities of food and bones. The filtering system helps keep food particles out of the wash water. Small particles are flushed away as water is pumped out. Larger particles are trapped in the pump guard.

To remove the pump guard for cleaning...

1. Wait at least 20 minutes after a cycle for the heating element to cool down.
2. Unload and remove the bottom rack.
3. Press the outside wall of the pump guard at the center to release the latch.
4. Lift out and rinse clean.

To replace the pump guard...

1. Insert pump guard legs (on inside wall) into matching openings in filter screen.
2. Press down on outside wall until latch snaps into place.
3. Replace bottom rack with rack bumpers in front.



Removable Pump Guard

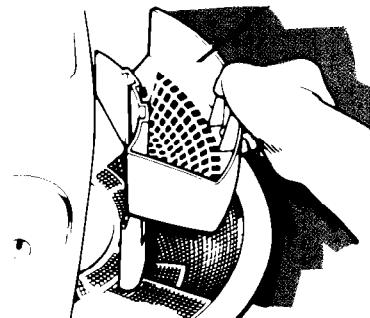

Water must be hot

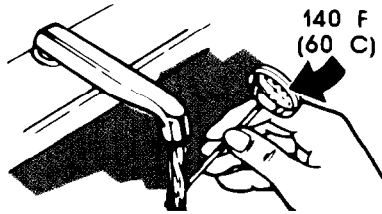

4

Check Water Temperature

For best cleaning and drying results, water should be at least 140°F (60°C).

1. Turn on hot water faucet nearest the dishwasher. Let water run until it is as hot as possible.
2. Hold a candy or meat thermometer in the stream of hot water to measure the temperature.
3. If the temperature is too low, have a qualified person raise the water heater thermostat setting.

Proper loading

Always load dishes so soiled surfaces are reached by spray from rotating spray arms. Water must be able to drain off completely for best drying results. Be careful to separate items so spray can reach all surfaces.

Top rack loading

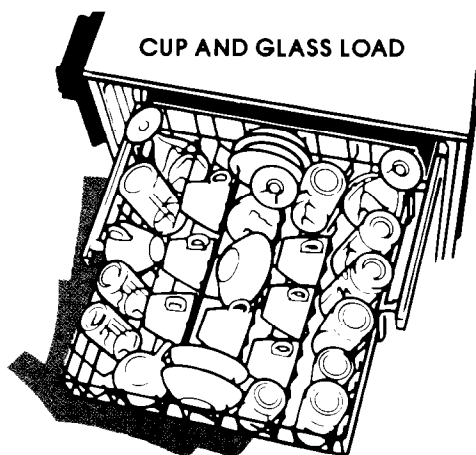

The top rack is designed for cups, glasses and smaller items.

- Place so open ends face down for cleaning and draining.
- **Load glasses in top rack only.** Bottom rack is not designed for glasses. Damage may occur.

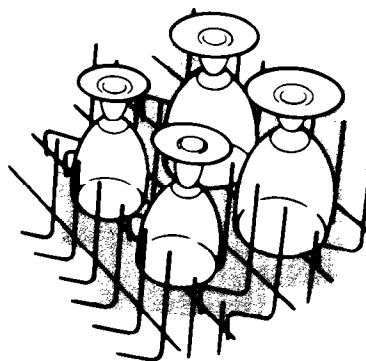

- Place items in the rows **between** prongs. Placing them **over** the prongs can lead to breakage.
- Be sure lightweight items are held firmly in place.
- China, crystal and other delicate items must not touch another item during dishwasher operation. Damage may occur.

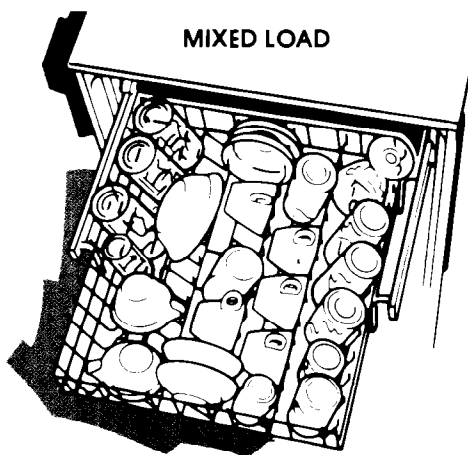

- Load plastic items **only in the top rack.** Only plastic items marked "dishwasher safe" are recommended.
- Plastic items can be melted in the bottom rack.

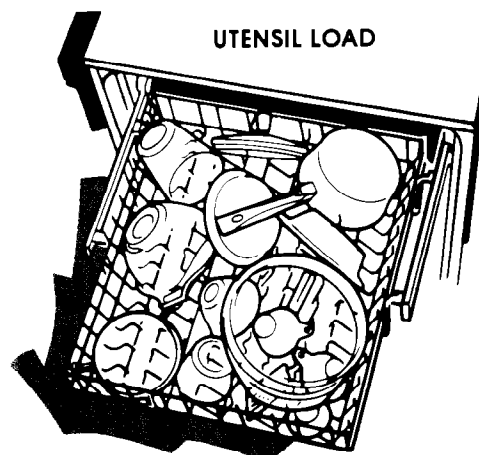

- Small bowls, pans and other utensils can be placed in the top rack.

- Items with cooked-on or dried-on foods should be loaded in the bottom rack with soiled surfaces facing the spray.

Bottom rack loading

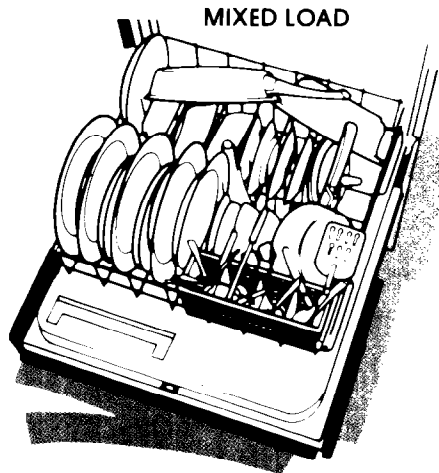

- Make sure pot handles and other items do not stop rotation of either the upper or lower spray arm. Spray arms must move freely.
- Securely place heavily soiled cookware face down in rack.

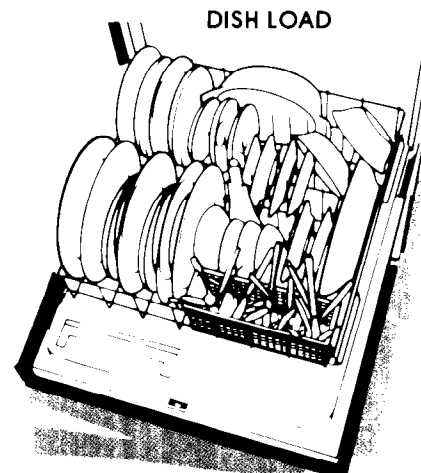

- Place plates, soup bowls, etc. **between** prongs and facing the spray.

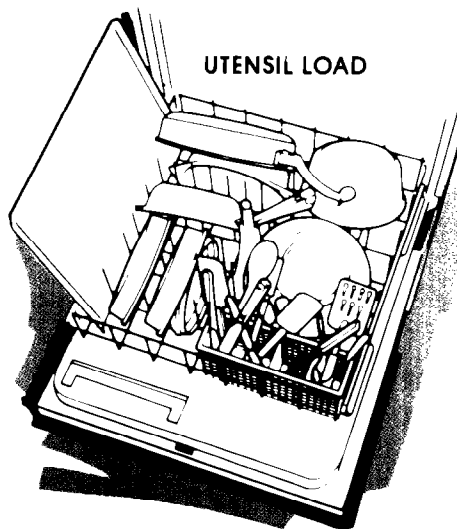

- Load cookie sheets, cake pans and other large items at sides and back. Loading such items in front may keep water spray from reaching detergent dispenser.

NOTE:

- Do not load glasses, cups or plastic items in the bottom rack.
- When lower rack is removed, replace with bumpers in front.

Silverware basket loading

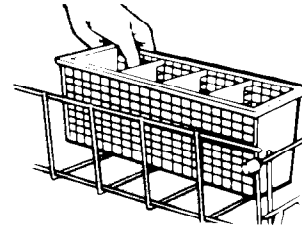

Load the silverware basket while it's in or out of the bottom rack. The loaded basket should be in the right front corner of the bottom rack.

NO



YES

Load forks and spoons so they **don't nest together**. Spray can't reach nested items.

Mix items in each section of the basket with some pointing up and some down.

Small items – baby bottle caps, jar lids, etc. – can be put in any section.



Make sure sharp items (knives, forks, skewers, etc.) are put in point down. Make sure long items do not stop the upper spray arm from turning.

Adding detergent

The kind and amount of dishwasher detergent you use is an important part of getting your dishes clean. Read this section carefully.

Use automatic dishwasher detergent only.

Other detergents are too mild and much too sudsy to work in the dishwasher.

Different brands of dishwasher detergent have different amounts of phosphorus. Phosphorus softens water and helps prevent water spots on dishes.

If water is hard and phosphorus content is low (8.7% or less), you may need to use more detergent or use a brand with a higher phosphorus content (12% or higher).

Do not add detergent until you are ready to wash. **Fresh, dry detergent is necessary for best washing results.** Store detergent tightly in a cool, dry place.

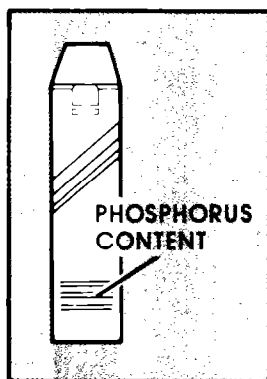
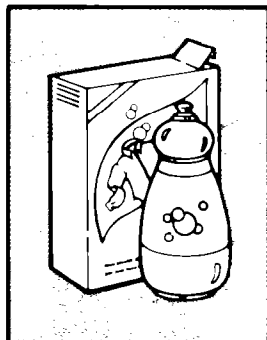

The detergent dispenser

The detergent dispenser has one section with a cover and one without.

- Put detergent in both sections for cycles with two washes.
- Put detergent in the covered section only for cycles with one wash.
- Push the cover down until it is latched.

The cover opens automatically when the main wash starts. Detergent in the open section falls into the dishwasher when the door is closed.

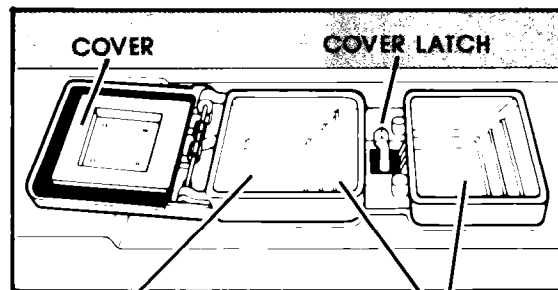
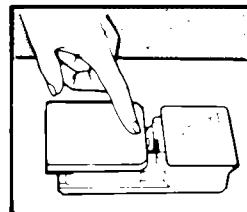

Use covered section for...
NORMAL LIGHT Cycle

Use both sections for...
NORMAL HEAVY Cycle

How much detergent to use

The amount of detergent to use depends on the hardness of your water. If too little is used, dishes won't be clean. However, if too much is used in soft water, glassware will begin to etch.

Find out your water's hardness by asking your local water department, water softener company or county extension agent.

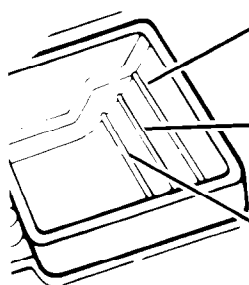

- **HARD** – Fill 1 or both sections to top line if water is 8 or more grains of hardness.
- **MEDIUM** – Fill 1 or both sections to middle line if water is 5 to 7 grains of hardness.
- **SOFT** – Fill one or both sections to bottom line if water is 0 to 4 grains of hardness.

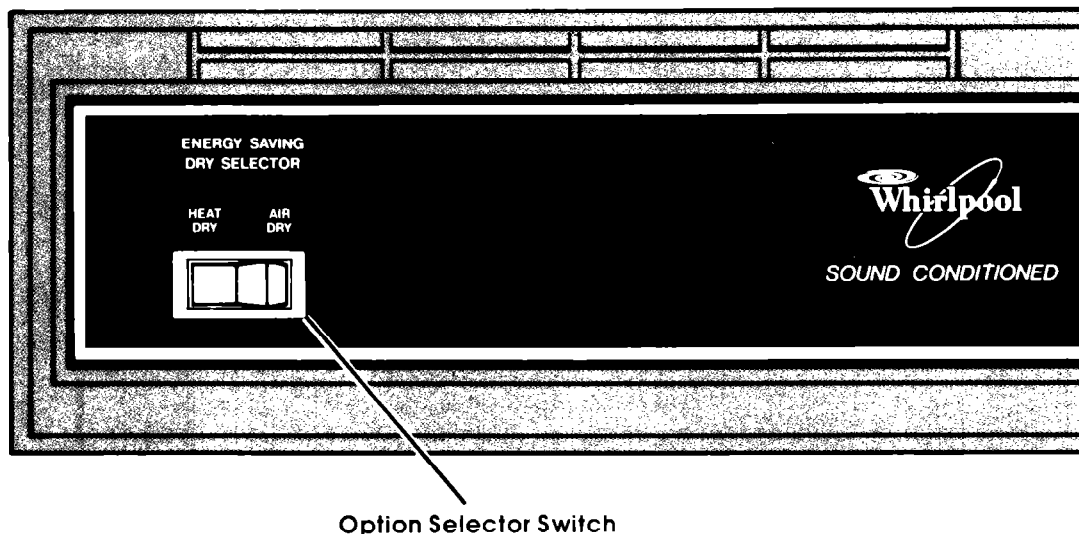

Option Selector Switch

Before starting your dishwasher

1. Spin the Upper Spray Arm to make sure nothing will stop it from turning freely.
2. Close and latch the door.
3. Run hot water at sink nearest dishwasher until it is hot. Turn it off. (See page 10 for connecting instructions.)

Starting your dishwasher

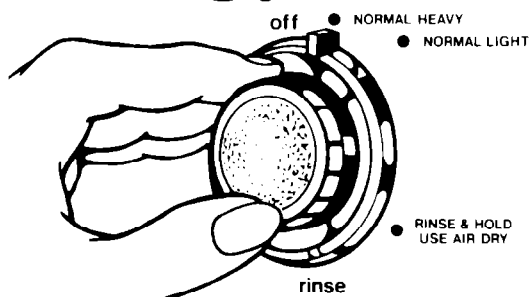

NORMAL HEAVY Cycle...

1. Make sure Cycle Control Knob points to dot marked NORMAL HEAVY.
2. Select option.
3. Without turning it, pull the Cycle Control Knob out to start the Cycle.

NORMAL LIGHT Cycle...

1. Turn Cycle Control Knob until it stops at dot marked NORMAL LIGHT.
2. Select option.
3. Without turning it, pull the Cycle Control Knob out to start the Cycle.

RINSE & HOLD Cycle...

1. Select AIR DRY Option only.
2. Unlatch door and open slightly.
3. Pull Cycle Control Knob out.
4. Turn Control Knob clockwise to dot marked RINSE & HOLD.
5. Close and latch the door to start the cycle.

Changing a setting

You can change a setting anytime during any cycle.

1. Unlatch the door to stop the cycle.
2. With the Cycle Control Knob **pulled out**, turn clockwise to the cycle you want.
3. Be sure the detergent dispensers are filled properly for the new cycle.
4. Latch the door to start the cycle.

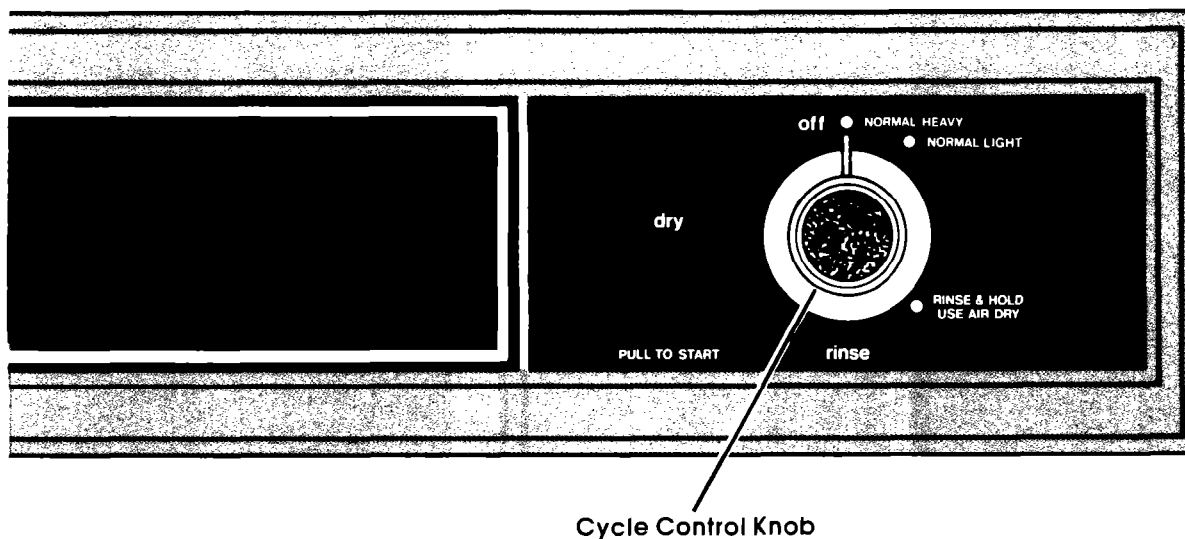

Selecting a cycle

NORMAL HEAVY Cycle

A double wash for normal to heavily soiled loads. (The Energy Guide Label data is based on this cycle.) Cycle time is about 60 minutes.

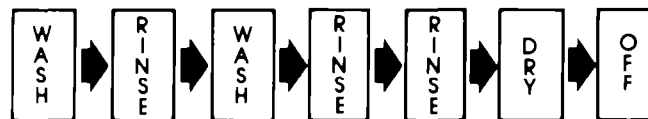

NORMAL LIGHT Cycle

For normal, everyday soiled loads. Cycle time is about 55 minutes.

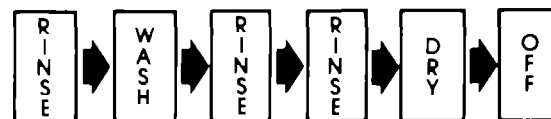

RINSE & HOLD Cycle

For rinsing a few items to be washed one or more days later. Cycle time is about 10 minutes.

Use AIR DRY only.

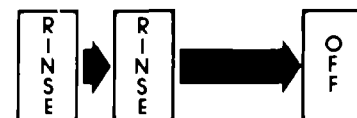

HEAT DRY or AIR DRY?

If the **HEAT DRY Option** is selected, air in the dishwasher is heated during the "dry" part of the cycle.

If the **AIR DRY Option** is selected, air in the dishwasher is not heated. Using this option helps save energy, but dishes take longer to dry (overnight) and some water spotting may result.

Some items (such as plastics) may need towel drying.

To add a dish after starting

- To be sure the added item is washed and rinsed, make sure the Cycle Control Knob has not passed **NORMAL LIGHT**.
- Unlatch the door to stop the cycle, but don't open it until the spray arms stop spinning.
- Open the door and add the dish.
- Close the door. **Do not latch it.** Wait 30 seconds for air in the dishwasher to warm up. This helps reduce the amount of moisture that can come from the vent when restarting the cycle.
- Latch the door. The dishwasher will start from where it stopped.

Connecting your portable dishwasher

A special adapter must be installed on the faucet before the dishwasher can be connected. Complete instructions and the adapter are packed with your dishwasher.

When moving your dishwasher, make sure the door is latched. Use the built-in pull bar or hold it at the top front corners.

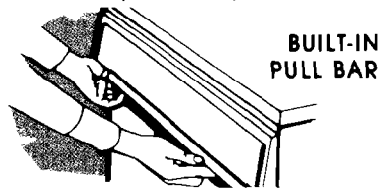

Before starting

1. Run water at faucet until it is **hot**. Turn it off.

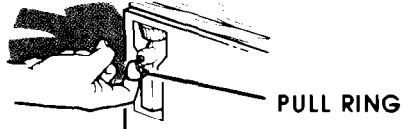

2. Pull hoses out of their storage compartment on the back.

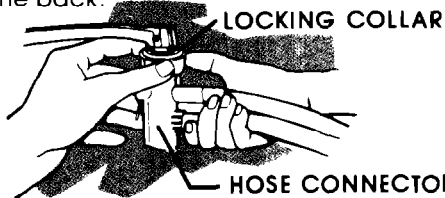

3. Pull down on the locking collar while lifting the hose connector onto the faucet adapter.
4. When the connector snaps into place, release the locking collar.
5. Turn the **hot** water on slowly until it is **all the way on**.
6. Plug in power supply cord.

Electrical Connection

A power supply of 120 volts, 60Hz AC only, 15 amps, is required. For your personal safety, this appliance must be grounded. This appliance is equipped with a power supply cord having a 3-prong grounding plug. To minimize possible shock hazard it must be plugged into a mating 3-prong grounding type wall receptacle, grounded in accordance with the National Electrical Code and local codes and ordinances. If a mating wall receptacle is not available, it is the personal responsibility and obligation of the customer to have a properly grounded 3-prong wall receptacle installed by a qualified electrician. **DO NOT** use an extension cord.

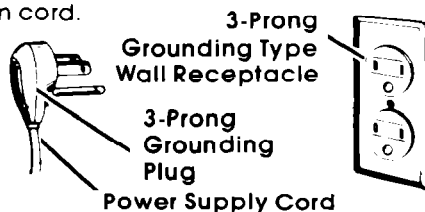

DO NOT, UNDER ANY CIRCUMSTANCES, REMOVE THE POWER SUPPLY CORD GROUND PRONG.

While dishwasher is running

You can draw water from the faucet while the dishwasher is connected. **DO NOT** draw water while the dishwasher is filling or while water is being pumped out. (This helps prevent a low fill when dishwasher is filling, or mixing drain water with fresh water.)

1. Press red button on hose connector to get the water you want. (The faucet is set on hot. Adjust faucet for the water you want.)
2. **Be sure you return cold water to off, and that hot water is full on.**

When cycle is finished

1. Turn hot water off. (This can be done after the last rinse.)
2. Press the red button on the connector to release the water pressure.
3. Lift slightly on the hose connector while pulling down the locking collar. Pull down on the connector.
4. Empty any remaining water from the connector.
5. Unplug power supply cord and return to storage compartment.
6. Return hoses to storage compartment.

Converting to built-in

Your Whirlpool Portable Dishwasher can be converted to a built-in (undercounter) model by using conversion kit No. 569056. The kit is available at your Whirlpool dealer or authorized TECH-CARE[®] Service Company. Instructions are included with the kit.

Caring for simulated wood top

The simulated wood top can be used as a utility work surface for most kitchen jobs. It is stronger and more easily cleaned than genuine wood.

The top can be used as a cutting board. Knife marks will be visible but will not seriously damage top. Hot items from the oven can be placed on the top.

Clean with warm, soapy water. For dried on foods, use a scouring pad.

Energy saving tips

You can help save energy if you:

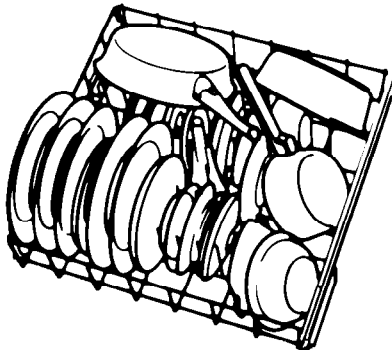

- 1. Wash full loads.** Running a half-filled dishwasher uses the same amount of electricity and hot water as a fully loaded machine.

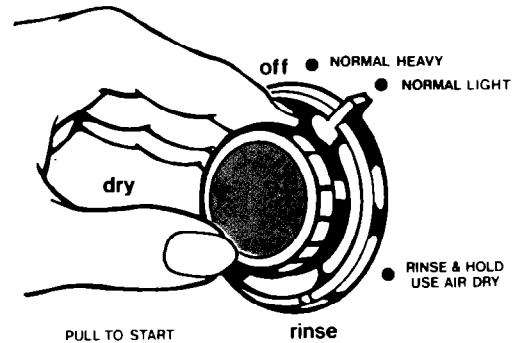

- 2. Use the NORMAL LIGHT Cycle** for normally soiled loads. It uses less hot water and energy than NORMAL HEAVY.

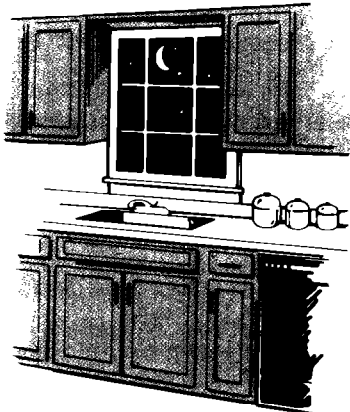

- 3. Air dry dishes** when you don't need a rapid drying cycle. Allow longer drying times (overnight).

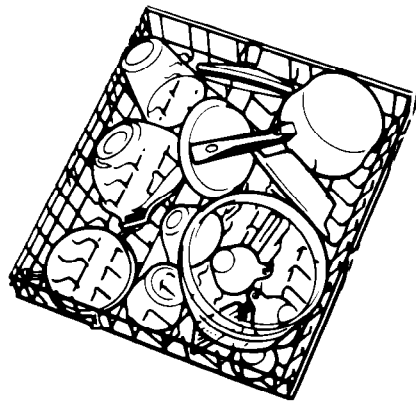

- 4. Load correctly** for best washing results. Incorrect loading may cause poor washing and the need to rewash all or part of the load.

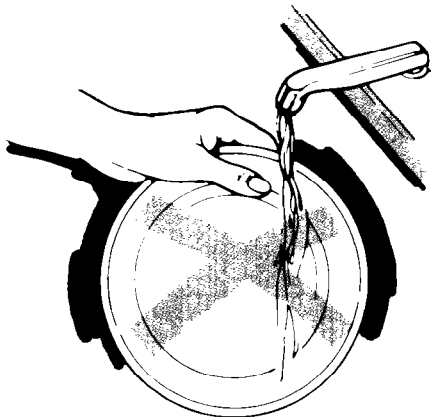

- 5. Don't pre-rinse normally soiled dishes.** Select the correct cycle for the load and use the recommended amount of detergent for good washing results without hand rinsing.

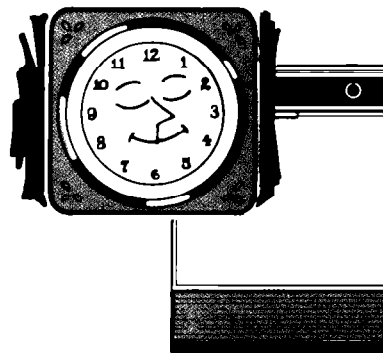

- 6. Use your dishwasher** during off-peak hours. Local utilities recommend this to avoid heavy usage of energy at certain times of day.

Common dishwashing problems

PROBLEM	CAUSED BY	SOLUTION
Spotting and filming	Hard water	Fill detergent dispensers to capacity. Use dishwasher detergent with highest available phosphorus content. May be necessary to install water softener.
	Water is not hot enough	Water temperature should be at least 140°F (60°C). Set water heater thermostat to a higher setting. Run water at sink until hot before starting.
	Not enough detergent, or improper detergent "Old" detergent	Use more dishwasher detergent. Use detergent with highest available phosphorus content...especially with hard water. Use only fresh, dry dishwasher detergent. Store tightly closed box, in cool, dry place. Discard old, lumpy detergent. Do not fill dispensers until ready to start dishwasher.
	Improper loading	Make sure dishes and glassware are loaded so spray reaches all surfaces and items drain properly. Do not overload. Do not nest items. Make sure large items do not block spray from reaching detergent dispensers.
	No rinse aid	Try a bar rinse aid such as Solid Jet DRY®. Follow package directions. To remove spots and film, try a vinegar rinse... 1. Wash and rinse load as usual. Use AIR DRY. 2. Remove all metal items. 3. Put 2 cups (500 mL) white vinegar in a container on the bottom rack. 4. Run dishwasher through a complete washing cycle.
	AIR DRY Setting used	Drying without heat may result in some spotting of glasses and silver.
Small particles deposited on items	Spray arm or arms not rotating freely "Old" detergent	Check spray arms to make sure they turn freely after loading. Be sure a utensil has not prevented their turning. Use only fresh, dry dishwasher detergent. Store tightly closed box in cool, dry place. Discard old, lumpy detergent. Do not fill dispensers until ready to start dishwasher.
	Not enough detergent, or improper detergent	Use more dishwasher detergent. Use detergent with highest available phosphorus content...especially with hard water.
	Water is not hot enough	Water temperature should be at least 140°F (60°C). Set water heater thermostat to a higher setting. Run water at sink until hot before starting.
	Water pressure may be low, dishwasher is not filling properly	If water pressure is low, do not use water for other purposes while dishwasher is running (to assure correct fills).
Dishes not dry	Water is not hot enough	Water temperature should be at least 140°F (60°C). Set water heater thermostat to a higher setting. Run water at sink until hot before starting.
	Improper loading	Make sure dishes and glassware are loaded so spray reaches all surfaces and items drain properly. Do not overload. Do not nest items.
	No rinse aid	Try a bar rinse aid such as Solid Jet DRY®. Follow package directions.
	AIR DRY Setting used	Allow more time when using AIR DRY Option, or use HEAT DRY. Plastic items may need towel drying.
Black marks on china or white utensils	Aluminum utensils rubbing against items during washing	Use care in loading aluminum utensils, especially any lightweight foil container. Place so they do not touch dishes. Remove black marks with plastic scouring pad and a mild abrasive cleanser.
Chipping or breaking glassware	Improper loading	Do not overload. Load glasses in the top rack only. Load between prongs, not over them. Glasses loaded over prongs will not be supported and may chip or break.

PROBLEM	CAUSED BY	SOLUTION
Dishes not washing clean	Water is not hot enough	Water temperature should be at least 140°F (60°C). Set water heater thermostat to a higher setting. Run water at sink until hot before starting.
	Improper loading	Make sure dishes and glassware are loaded so spray reaches all surfaces and items drain properly. Do not overload. Do not nest items. Make sure large items do not block spray from reaching detergent dispensers.
	Spray arm or arms not rotating freely	Check spray arms to make sure they turn freely after loading. Be sure a utensil has not prevented their turning.
	Not enough detergent or improper detergent	Use more dishwasher detergent. Use detergent with highest available phosphorus content... especially with hard water.
	"Old" detergent.	Use only fresh, dry dishwasher detergent. Store tightly closed box in cool, dry place. Discard old, lumpy detergent. Do not fill dispensers until ready to start dishwasher.
	Water pressure may be low, dishwasher is not filling properly	If water pressure is low, do not use water for other purposes while dishwasher is running (to assure correct fills).
Etching – permanent filming which cannot be removed	Too much detergent in soft water	Check for rainbow hue on glasses. A rainbow hue is the first sign of etching (corrosion of glass). Reduce the amount of dishwasher detergent. Use a detergent with a lower phosphorus content.
	Inadequate rinsing	If water pressure is low do not use water for other purposes while dishwasher is running (to assure correct water fills). Make sure dishes and glassware are loaded properly to assure adequate rinsing and draining. Do not overload.
Dishes & interior of dishwasher yellow or brown	Iron or manganese in water	Temporary remedy: 1. Set empty dishwasher for a "one wash" cycle. 2. Start dishwasher and unlatch door to stop it when it has filled for the wash part of the cycle. 3. Add ¼ to ½ cup (120 to 240 mL) of citric acid crystals (usually available in drugstores). 4. Close and latch door to complete cycle. Permanent solution: Install an iron or manganese filter to home water supply
Small dark spots on flatware – stainless steel, silver plate, or sterling or rust spots on stainless steel	Allowing salty or acidic foods such as mayonnaise, vinegar, fruit juices, salad dressings, milk products to remain on flatware.	Rinse flatware that is to stand for several hours before washing (use Rinse & Hold). Clean stained items with silver polish and re-wash. Do not put stainless steel and silver flatware in the same silverware basket compartment. Direct contact between these metals can cause permanent damage to the silver.
	Undissolved detergent coming in contact with flatware	Remove spots with silver polish. Avoid spilling dry detergent on wet flatware.
Bronze tarnish on silverplate	Silverplate is worn off. Exposed base metal takes on a bronzed hue.	Remove tarnish with silver polish. Have silver replated.
Water left in bottom of dishwasher	Dishwasher cycle not completed	Allow dishwasher to complete cycle.
	Clogged drain air gap	Some plumbing codes require use of a drain air gap between an undercounter dishwasher and the drain system of the house. The air gap is usually located above the sink or on the top of the counter near the dishwasher to prevent the possibility of water backing up from the drain into the dishwasher due to a plugged drain. The drain air gap is NOT a part of the dishwasher and is NOT covered by the dishwasher warranty. The drain air gap should be kept clean to insure proper draining of the dishwasher.

Special tips on dishwasher use

Remember, use your dishwasher only for the job it was designed to do. Some items are not dishwasher safe or may require special care. Read these special tips.

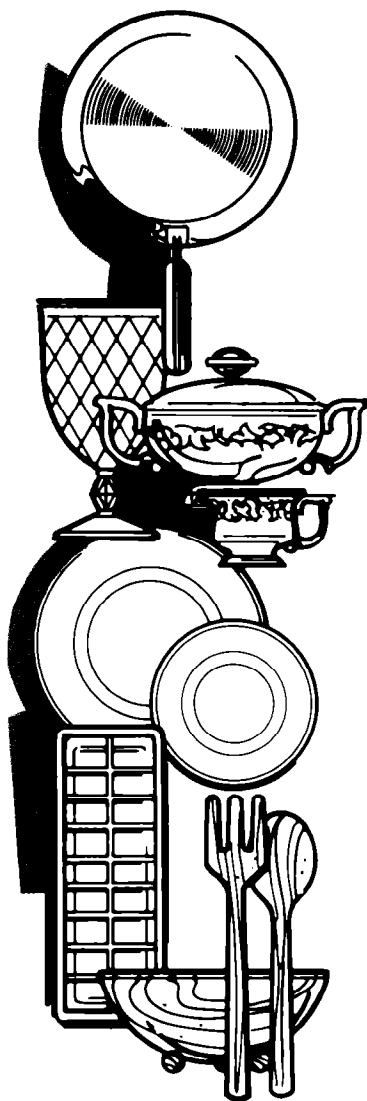

Aluminum: Aluminum loses its bright, shiny appearance and darkens in color due to the minerals in the water and the alkalinity of the dishwasher detergent. If washed in the dishwasher avoid placing directly in front of detergent dispenser where it could be sprinkled with undissolved detergent, causing spotting, pitting, and discoloration.

Colored aluminum: Colored aluminum may fade. Follow utensil manufacturers' cleaning instructions.

China: Load carefully. **Do not** allow pieces to touch each other. Use the **shortest** washing cycle (see page 9). Hand-painted, metal-trimmed, and antique china may fade due to hot water and detergent. Test one piece by washing it daily in the dishwasher for several weeks. Then compare it with the rest of the set to see if colors have changed. Delicate, antique items should be hand washed.

Crystal and glasses: Load carefully in **top rack only**. Load between prongs—not over them—to help prevent bumping and chipping. Load a few larger items in the bottom rack to reduce amount and force of water spray reaching glassware from the bottom spray arm. Use the **shortest** washing cycle (see page 9). Delicate, antique items should be hand washed.

Flatware: Salty and acidic foods may tarnish silver and stainless flatware if allowed to remain on the utensils. Rinse flatware as soon as possible especially if it is not to be washed right away. Clean tarnished items with silver polish. Antique finishes may be removed by the dishwasher detergent. Wash by hand. A film may form on sterling silver and silver plate items washed in a dishwasher. This film is caused by a reaction of silver with chlorine in the detergent. It can be removed with silver polish. Gold flatware is not dishwasher safe.

Cast iron utensils: The seasoned finish will be removed in the dishwasher. Rusting will result. Wash by hand. To re-season, coat with unsalted fat and heat in a slow oven for an hour or two.

Plastics: Place in upper rack only. Many plastics will have "Dishwasher Safe" written on them. If in doubt, try one piece.

Non-stick finish utensils: Most can be washed in the dishwasher. Follow manufacturers' suggestions.

Wood: Many wooden items will warp or lose their finish. Do not wash cutting boards, wooden salad bowls or knives with wooden handles in the dishwasher.

Pewter or pewter-like materials: May streak, discolor, and pit. To keep pewter at its very best, hand wash with mild detergent.

Dishwasher care & cleaning: Regular use of a soft damp cloth or sponge and a mild detergent is all that is necessary, in most cases, to keep the outside of your dishwasher nice looking and clean. Prolonged use of hard water may cause a white film to build up on the inside surfaces. If needed, clean inside with dishwasher detergent and water.

If you need service or assistance, we suggest you follow these four steps:

1. Before calling for assistance... 3. If you need service* ...

Performance problems often result from little things you can find and fix yourself without tools of any kind.

- If dishwasher won't run, or stops during cycle:
 - Is door tightly closed and securely latched?
 - Has cycle been correctly set (and control knob pulled out)?
 - Is water turned on?
 - Has house fuse blown or circuit breaker tripped?
 - Is the power cord plugged in (if so equipped)?
 - Has electrical power been interrupted?
 - If motor has stopped because of overload, it will automatically reset itself within a few minutes. If motor does not start, call for service.
- If water remains in the dishwasher:
 - Has the cycle completed?
 - A small amount of water may remain in the removable pump guard section of the filter.
- If detergent remains in the covered detergent cup:
 - Is the bottom rack in backwards? (The rack bumpers should be at the front.)
 - Is the dishwasher detergent fresh and dry without lumps?
 - Is the cycle completed?

2. If you need assistance* ...

Call Whirlpool COOL-LINE® service assistance telephone number. Dial free from:

Continental U.S. (800) 253-1301
 Michigan (800) 632-2243
 Alaska & Hawaii (800) 253-1121

and talk with one of our trained Consultants. The Consultant can instruct you in how to obtain satisfactory operation from your appliance or, if service is necessary, recommend a qualified service company in your area.



Whirlpool has a nationwide network of franchised TECH-CARE® Service Companies. TECH-CARE service technicians are trained to fulfill the product warranty and provide after-warranty service, anywhere in the United States. To locate TECH-CARE service in your area, call our COOL-LINE service assistance telephone number (see Step 2) or look in your telephone directory Yellow Pages under:

APPLIANCES - HOUSEHOLD - MAJOR - SERVICE & REPAIR
 WHIRLPOOL APPLIANCES FRANCHISED TECH-CARE SERVICE
 OR
 ELECTRICAL APPLIANCES - MAJOR - REPAIRING & PARTS
 WHIRLPOOL APPLIANCES FRANCHISED TECH-CARE SERVICE

SERVICE COMPANIES
 XYZ SERVICE CO
 123 Maple 999-9999
 OR
 SERVICE COMPANIES
 XYZ SERVICE CO
 123 Maple 999-9999

OR
 WASHING MACHINES, DRYERS & IRONERS - SERVICING

WHIRLPOOL APPLIANCES
 FRANCHISED TECH-CARE SERVICE

SERVICE COMPANIES
 XYZ SERVICE CO
 123 Maple 999-9999



FSP is a registered trademark of Whirlpool Corporation for quality parts. Look for this symbol of quality whenever you need a replacement part for your Whirlpool appliance. FSP replacement parts

will fit right and work right, because they are made to the same exacting specifications used to build every new Whirlpool appliance.

4. If you have a problem* ...

Call our COOL-LINE service assistance telephone number (see Step 2) and talk with one of our Consultants, or if you prefer, write to:

Mr. Robert F. Gunts, Vice President
 Whirlpool Corporation
 Administrative Center
 2000 US-33 North
 Benton Harbor, MI 49022

*If you must call or write, please provide: model number, serial number, date of purchase, and a complete description of the problem. This information is needed in order to better respond to your request for assistance.



Making your world a little easier.

Part No. 304086
©1984 Whirlpool Corporation

Printed in U.S.A.

Ice Makers, Dishwashers, Built-In Ovens and Surface Units, Ranges, Microwave Ovens, Trash Compactors, Room Air Conditioners, Dehumidifiers, Automatic Washers, Clothes D

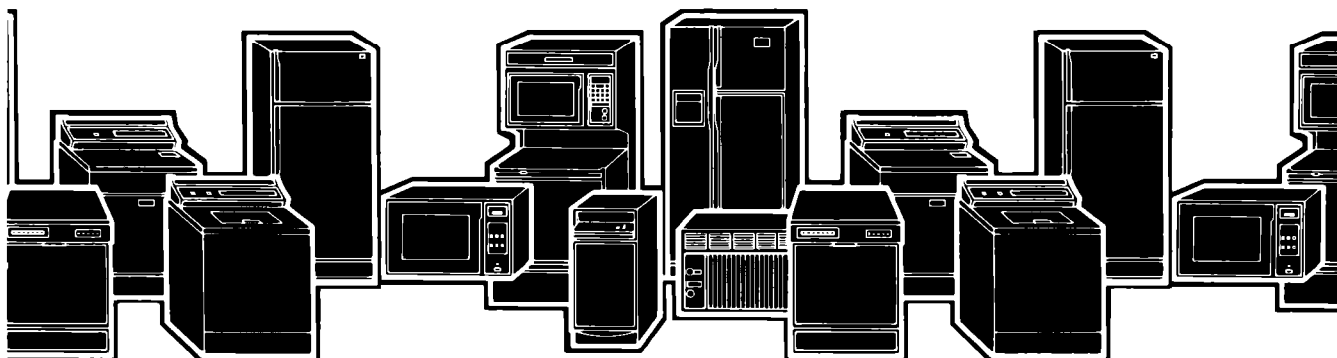

Download from www.Somanuals.com. All Manuals Search And Download.

Free Manuals Download Website

<http://myh66.com>

<http://usermanuals.us>

<http://www.somanuals.com>

<http://www.4manuals.cc>

<http://www.manual-lib.com>

<http://www.404manual.com>

<http://www.luxmanual.com>

<http://aubethermostatmanual.com>

Golf course search by state

<http://golfingnear.com>

Email search by domain

<http://emailbydomain.com>

Auto manuals search

<http://auto.somanuals.com>

TV manuals search

<http://tv.somanuals.com>