

Installation Instructions

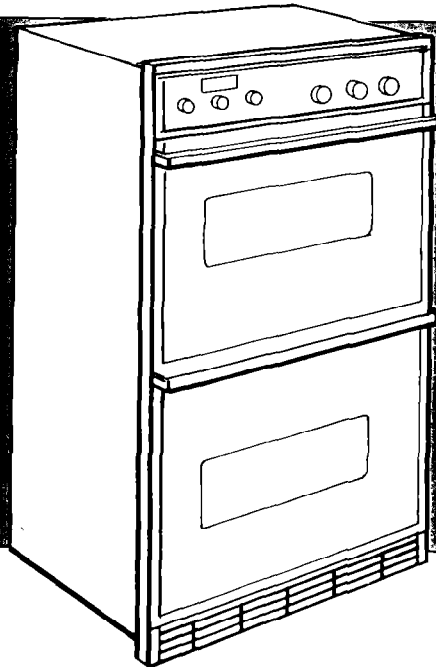

Part No. 3149595

IMPORTANT

Installer: Leave Installation Instructions with the homeowner.

Homeowner: Keep Installation Instructions for future reference.

Save Installation Instructions for local electrical inspector's use.

30" Electric Double Oven



Before you start...

Proper installation is your responsibility. A qualified technician should install this oven. Make sure you have everything necessary for installation. It is the responsibility of the installer to comply with the installation clearance specified on the serial/rating plate. The serial/rating plate can be found behind the upper oven door on the oven frame.

Check location where the double oven will be installed. The location should be away from strong draft areas, such as windows, doors, and strong heating vents or fans. The double oven should be located for convenient use in the kitchen.

Cabinet opening dimensions that are shown must be used. Given dimensions provide 0" clearance. Dimensions given are for a double oven sitting on a contact surface 2-3/4" below the open, lower oven door height. The contact surface must be solid and level and flush with the bottom of the cabinet opening.

The recessed installation area must provide complete enclosure around the recessed portion of the oven.

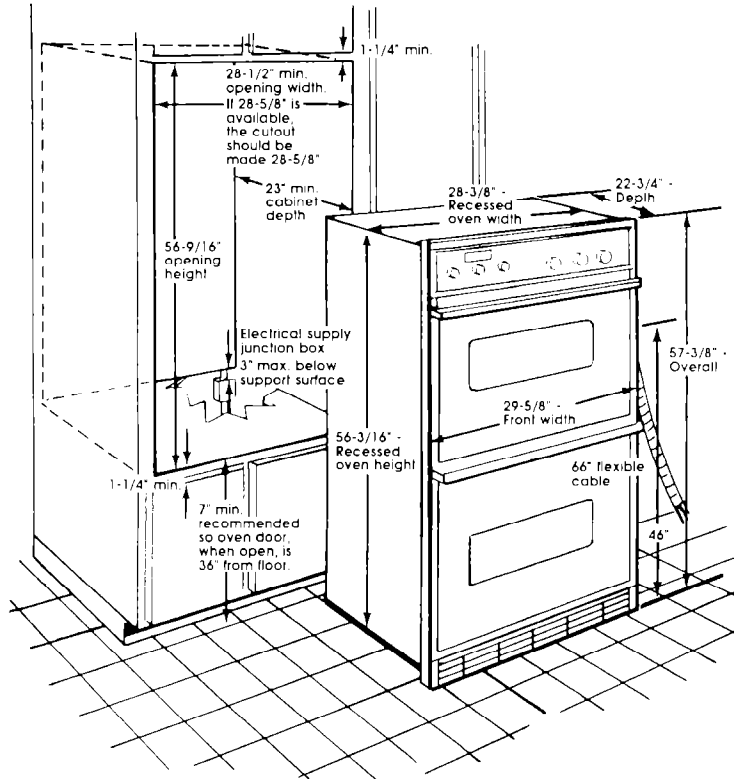

Electrical ground is required. See "Electrical requirements".

Note: Clearances specified are for combustible walls and materials that have a density of 20 or more pounds per cubic foot. No evaluation of clearances has been made for installations adjacent to materials that are less than 20 pounds per cubic foot or to plastic tiles and sheeting.

Important: observe all governing codes and ordinances.

⚠ WARNING

Electrical Shock Hazard
It is the customer's responsibility:

- To contact a qualified electrical installer.
- To assure that the electrical installation is adequate and in conformance with National Electrical Code ANSI/NFPA 70-latest edition*, and all local codes and ordinances.

Failure to do so could result in fire, electrical shock or other personal injury.

⚠ CAUTION

Personal Injury/Product Damage Hazard

- Do Not block oven vent. Blocking the vent could result in poor baking performance and damage to the cabinet.
- Securely fasten oven to cabinets using the eight screws provided.

Failure to do so could cause the oven to move or tip during use and result in personal injury or product damage.

Mobile home installation

The installation of this oven must conform to the Manufactured Home Construction and Safety Standards, Title 24 CFR, Part 3280 (formerly the Federal Standard for Mobile Home Construction and Safety, Title 24, HUD, Part 280).

A four-wire, power supply cord must be used in a mobile home installation. The appliance wiring will need to be revised. See "Electrical requirements", Figure 4, Panel B.

Copies of the standards listed may be obtained from:
* National Fire Protection Association
Battery March Park
Quincy, Massachusetts 02169

Tools needed for installation:

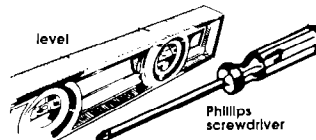

Electrical requirements

Electrical ground is required on this appliance.

⚠ WARNING

Electrical Shock Hazard

- Electrical ground is required on this appliance.
- Improper connection of the equipment-grounding conductor can result in a fire, electrical shock or other personal injury.
- Check with a qualified electrician if you are in doubt as to whether the appliance is properly grounded.
- Do Not use an extension cord with this appliance. Such use may result in a fire, electrical shock, or other personal injury.
- Do Not have a fuse in the neutral or grounding circuit. This could result in an electrical shock.

Save installation instructions for the local electrical inspector's use.

A. A three-wire or four-wire, single phase, 120/240-volt, 60-Hz, AC only, electrical supply (or three-wire or four-wire, 120/208-volt if specified on the nameplate) is required on a separate, 30-ampere circuit, fused on both sides of the line. (Time-delay or circuit breaker is recommended.)

The fuse size must not exceed the circuit rating of the appliance specified on the serial/rating plate. The serial/rating plate is located on the cabinet behind the upper oven door.

B. THE OVEN MUST BE CONNECTED WITH COPPER WIRE ONLY. Aluminum wire must **Not** be used to avoid potentially unsatisfactory connections.

C. Wire sizes (COPPER WIRE ONLY) and connections must conform to the requirements of the National Electrical Code ANSI/NFPA 70-latest edition*, and all local codes and ordinances for the kilowatt rating of the oven.

D. The appliance should be connected directly to the fused disconnect or circuit breaker box through flexible, armored or non-metallic sheathed copper cable (with a grounding wire). The flexible, armored cable extending from the appliance should be connected directly to the junction box.

E. Locate the junction box to allow as much slack as possible between the junction box and the appliance so that the oven can be moved if servicing is ever necessary. Do Not cut the conduit.

F. A 3/4", U.L.-listed strain relief must be provided at the junction box.

G. It is the personal responsibility and obligation of the customer to contact a qualified electrician to assure that the electrical installation is adequate and in conformance with the National Electrical Code ANSI/NFPA 70-latest edition, and all local codes and ordinances.

* Copies of the standard listed may be obtained from:
National Fire Protection Association
 Battery March Park
 Quincy, Massachusetts 02169

H. A wiring diagram is included in the Tech-sheet (located behind the air grille) with self-cleaning ovens. For other models, the wiring diagram is located on the back, right-hand side of the oven.

Electrical connection

Electrical ground is required on this appliance.

⚠ WARNING

Electrical Shock Hazard

- Do Not connect appliance to electrical supply until appliance is permanently grounded.
- Disconnect power to the junction box before making the electrical connection.
- This appliance must be connected to a grounded, metallic, permanent wiring system, or a grounding conductor should be connected to the grounding terminal or lead on the appliance.

Failure to follow these instructions could result in a fire, personal injury, or electrical shock.

This appliance is manufactured with the neutral (white) power supply wire and a cabinet-connected grounding wire (green) twisted together.

Connect the appliance cable to the junction box through the 3/4", U.L.-listed strain relief. Complete the electrical connection according to local codes and ordinances.

A. Where local codes permit...

Connecting the cabinet-grounding conductor to the neutral (white) junction box wire:

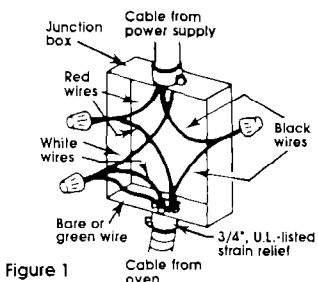

Figure 1

1. Connect together three wires: the green (or bare) and white appliance cable wires with the neutral (white) wire in the junction box.

2. Connect the two black wires; then the two red wires. (See Figure 1.)

B. Where local codes Do Not permit...

Connecting the cabinet-grounding conductor to the neutral (white) junction box wire:

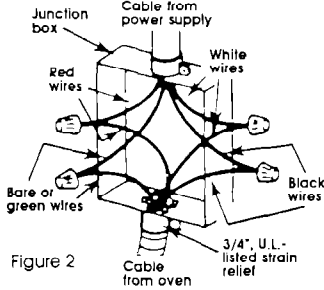

Figure 2

1. Separate the green (or bare) and white appliance cable wires.
2. Connect the white appliance cable wire with the neutral (white) wire in the junction box.
3. Connect the two black wires; then connect the two red wires. (See Figure 2.)
4. Connect the grounding wire to a grounded wire in the junction box or to a grounded, copper, cold water pipe*.

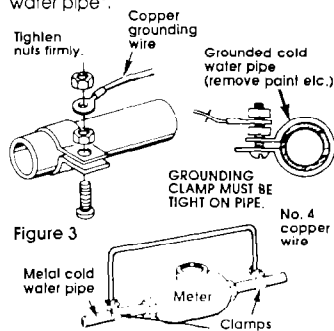

Figure 3

5. A separate, copper grounding wire (No. 18 minimum) must be connected to a grounded, cold water pipe by means of a clamp and then to the external grounding connector screw. **Do Not ground to a gas supply pipe or hot water pipe.** Do Not connect to the electrical supply until appliance is permanently grounded.

* Grounded cold water pipe must have metal continuity to electrical ground and not be interrupted by plastic, rubber or other electrical insulating connectors such as hoses, fittings, washers or gaskets (including water meter or pump). Any electrical insulating connector should be jumped, as shown, with a length of No. 4 copper wire securely clamped to bare metal at both ends.

C. If connecting to a four-wire electrical system...

Do Not connect the cabinet-grounding conductor to the neutral (white) wire in the junction box.

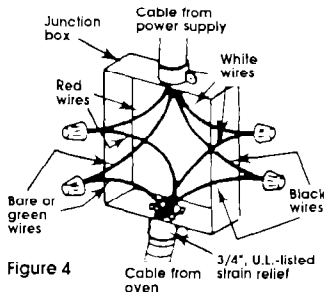

Figure 4

1. Separate the green (or bare) and white appliance cable wires.
2. Connect the white appliance cable wire to the neutral (white) wire in the junction box.
3. Connect the two black wires; then connect the two red wires. (See Figure 4.)
4. Connect the green appliance cable wire to the green grounding wire in the junction box.

Now start...

With oven in kitchen...

1. Remove shipping materials, tape and protective film from oven. **Do Not remove the shipping base at this time.**

2. Remove the racks and other parts from inside the oven. Remove the air grille taped to the top or side of the oven.

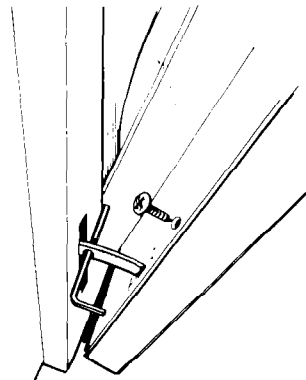

3. Upper oven door: Remove the screws on each side of the inner panel of the oven door. Insert a nail (or an equivalent, 5/32" diameter item) into the hole in each of the hinges. Close the door as far as possible. Lift the oven door off of the hinges. Set aside.

Lower oven door: Open the oven door to the broil "stop" position and lift door upwards to remove. Set oven door aside.

CAUTION

Floor Damage
Keep shipping base under oven when moving across floor. Failure to do so may cause damage to floor covering.

- 4.** Move oven close to cabinet opening. Make the electrical connection. See "Electrical requirements" and "Electrical connection" sections, Panels A and B, for details.

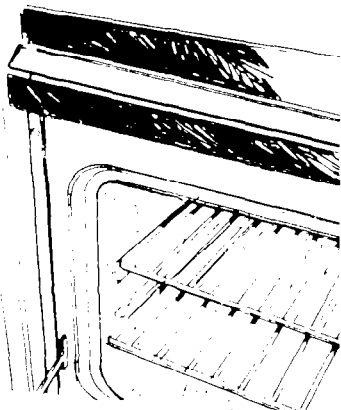

- 5.** Remove and discard the shipping base. Lift oven up into cabinet opening using the oven opening as an area to grip. Thread cable through opening in cabinet.

CAUTION

Personal Injury/Product Damage Hazard
Securely fasten oven to cabinets using the eight screws provided. Failure to do so could cause the oven to move or tip during use and result in personal injury or product damage.

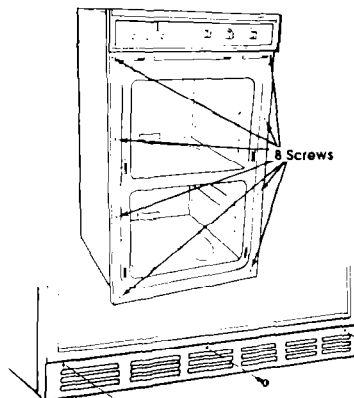

- 6.** Center oven in cabinet cutout. Secure oven to cabinet using eight screws through the mounting holes in the front frame of the oven.

- 7.** Put the air grille in place below the lower oven opening, making sure that the louvers in the air grille point down, the flange is at the bottom, and the mounting holes are at the top. Slide the air grille into position and attach it to the oven cabinet with the three, black or chrome, metal screws provided.

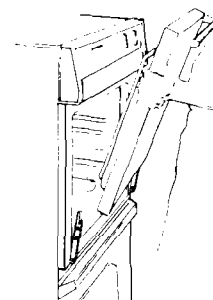

- 8.** Replace the upper oven door by fitting both corners of the door over the ends of the hinges. Push the door evenly and completely onto the hinges. Remove the nails from the hinges. Reinstall two screws in the inner door panel. Close the oven door. If the door does not close, you have not pushed the door completely onto the hinges. Repeat for the lower oven door.

9.

Turn on power supply. Check the operation of the oven elements. Set the oven selector control knob to "BAKE". (The oven selector control knob is not available on all models.) Set the oven temperature control knob to 350°F. The bottom element should glow red and the indicator light should be on. The upper element should become hot, but not glow red. The oven indicator light goes off when the oven is preheated. Repeat for the lower oven.

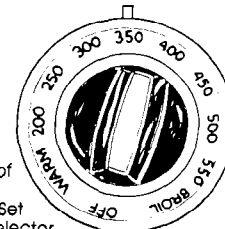

10.

Check the operation of the broil element. Set the oven selector and oven temperature control knobs to "BROIL". (The oven selector control knob is not available on all models.) The top element should glow red and the indicator light should be on. Repeat for the lower oven broil element.

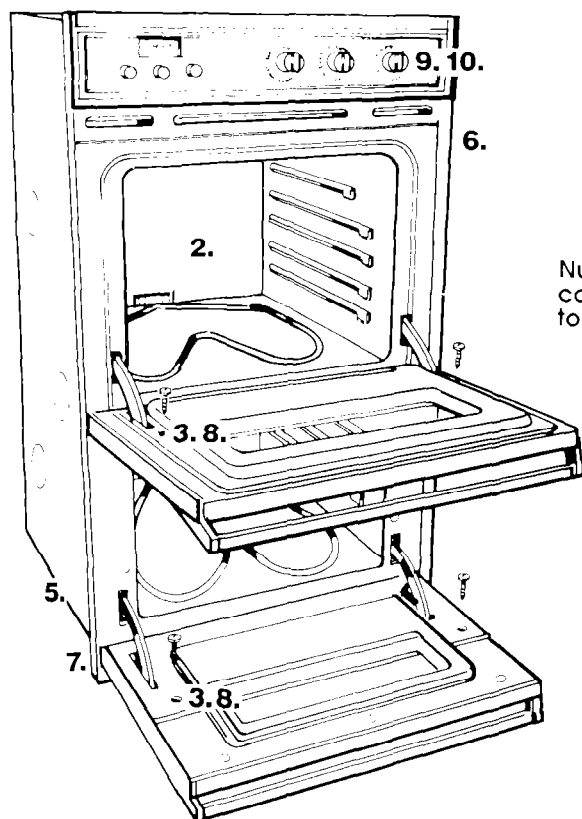
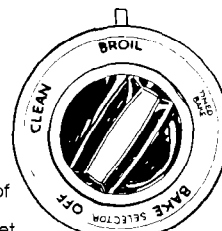

Numbers correspond to steps.

You have just finished installing your new Whirlpool oven. To get the most efficient use from your new oven, read your Whirlpool Use and Care Guide. Keep Installation Instructions and Guide close to oven for easy reference. The Instructions will make reinstalling your Whirlpool oven in another home as easy as the first installation.

Congratulations!

Instructions and Guide close to oven for easy reference. The Instructions will make reinstalling your Whirlpool oven in another home as easy as the first installation.

If the oven does not operate...

Check that the circuit breaker is not tripped or the fuse blown. A more detailed, trouble-shooting checklist is provided in the Use and Care Guide.

If you need assistance...

During normal business hours, the Whirlpool COOL-LINE® Service will answer any questions about operating and maintaining your oven not covered in the Installation Instructions. The Whirlpool COOL-LINE® Service telephone number is (800) 253-1301. Dial just as you normally dial long distance — the call is free. When you call, you need the oven model number and serial number. Both numbers can be found on the serial/rating plate located on the frame behind the oven door.

If you need service...

In the event your Whirlpool appliance should need service, call the dealer from whom you purchased the appliance or a Whirlpool franchised TECH-CARE® service company. He is in the Yellow Pages of your telephone directory listed under "Appliances — Household — Major — Service or Repair". You can also obtain his name and number by dialing, free, within the continental United States, the Whirlpool COOL-LINE® Service number, (800) 253-1301. A special operator will tell you the name and telephone number of your nearest Whirlpool TECH-CARE® service outlet.

Maintain the quality built into your Whirlpool appliance — call TECH-CARE® service.



Free Manuals Download Website

<http://myh66.com>

<http://usermanuals.us>

<http://www.somanuals.com>

<http://www.4manuals.cc>

<http://www.manual-lib.com>

<http://www.404manual.com>

<http://www.luxmanual.com>

<http://aubethermostatmanual.com>

Golf course search by state

<http://golfingnear.com>

Email search by domain

<http://emailbydomain.com>

Auto manuals search

<http://auto.somanuals.com>

TV manuals search

<http://tv.somanuals.com>