

use & care guide

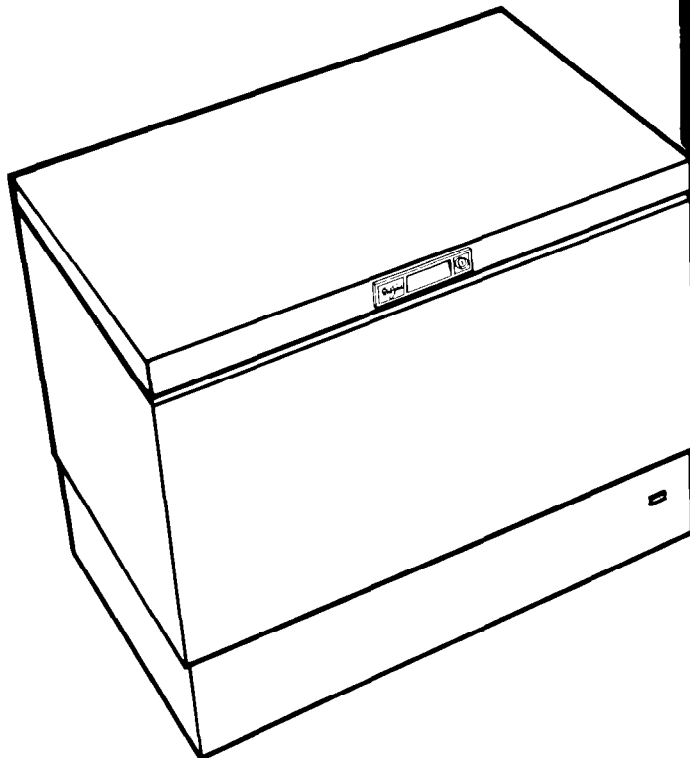

The Whirlpool logo, featuring a stylized swirl above the word "Whirlpool" in a serif font.

CHEST FREEZER

Models EH060F
EH090F

or-Freezers, Ice Makers, Dishwashers, Built-In Ovens and Surface Units, Ranges, Microwave Ovens, Trash Compactors, Room Air Conditioners, Dehumidifiers, Automatic Washers, Clothes Dryers, Freeze

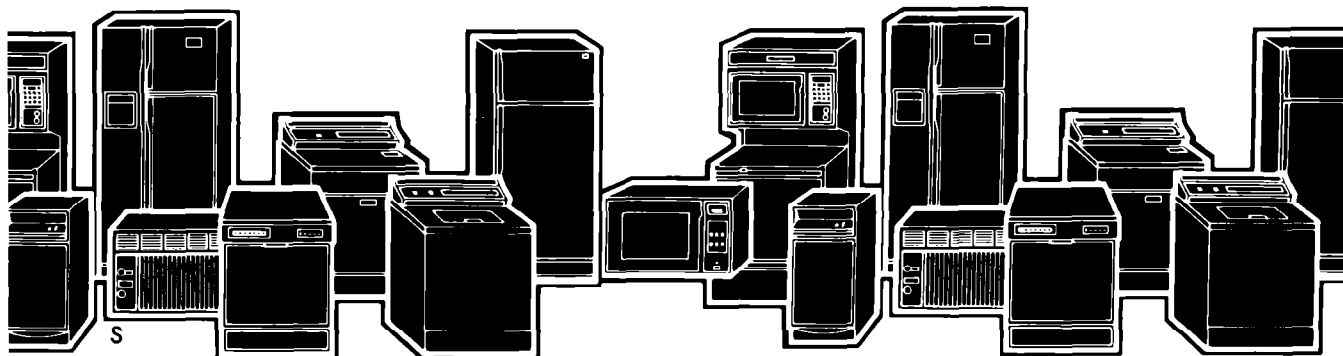

Please read this Use and Care Guide before you do anything else...

This booklet tells you how to start your freezer, defrost it, clean it and adjust controls.
Treat your new freezer with care. Use it only to do what home freezers are designed to do.

Parts and features

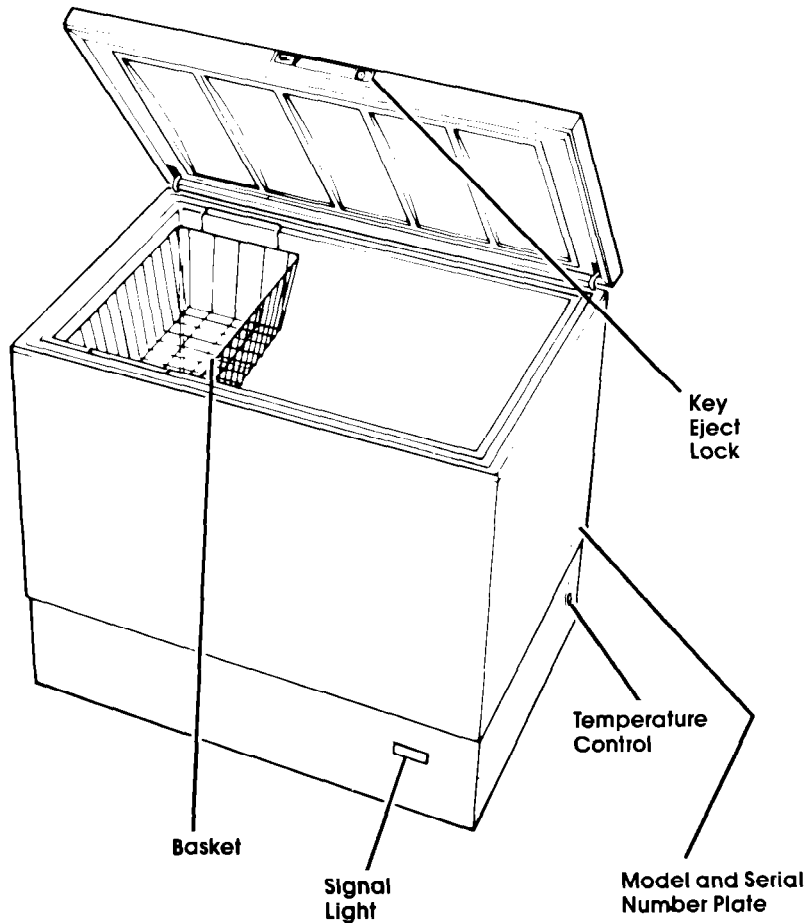

Copy your Model and Serial Numbers here...

When you need service, or call with a question, have this information ready:

1. **Complete** Model and Serial Numbers from the plate located as shown.
2. Purchase date from sales slip.

Copy this information in these spaces. Keep this book, your warranty and sales slip together in a handy place.

Please complete and mail the Owner Registration Card furnished with this product.

Model Number _____

Serial Number _____

Purchase Date _____

Service Company and Telephone Number _____

Contents

	Page		Page
SAFETY FIRST	3	Energy Saving Tips	6
BEFORE YOU PLUG IT IN	3	CLEANING YOUR FREEZER	6
Install Properly	4	Cleaning Chart	6
Level Chest Freezer	4	FREEZING FOOD IN YOUR FREEZER	7
Remove Sales Labels	4	Packaging and Sealing Food	7
Clean It	4	To Wrap Foods	7
Plug It In	4	Loading	8
USING YOUR FREEZER	5	Storing Frozen Food	8
Setting the Temperature Control	5	VACATION AND MOVING CARE	9
Adjusting the Temperature Control	5	Vacations	9
Cooling Freezer First	5	Shutting Off and Moving	9
The Sliding Basket	5	IF YOU NEED SERVICE OR ASSISTANCE	10
The Key Eject Lock	5	FREEZER WARRANTY	12
The Signal Light	5	REIMBURSEMENT FOR FOOD LOSSES	12

©1987 Whirlpool Corporation

Safety first

Child entrapment and suffocation are not problems of the past. Junked or abandoned freezers are still dangerous...even if they will "just sit in the garage for a few days."

If you are getting rid of your old freezer, do it safely. Please read the enclosed safety booklet from the Association of Home Appliance Manufacturers. Help prevent accidents.

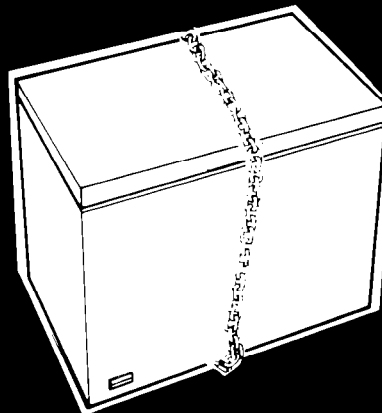

Before you plug it in

IMPORTANT

Before using your freezer, you are personally responsible for making sure that it...

- is installed and levelled on a floor that will hold the weight, and in an area suitable for its size and use.
- is connected only to the right kind of outlet, with the right electrical supply and grounding. (Refer to your "Electrical Requirements and Grounding Instructions.")
- is used only for jobs expected of home freezers.
- is not near an oven, radiator or other heat source.
- is properly maintained.
- is out of the weather.
- is used in an area where the room temperature will not exceed 110°F (43.3°C).
- is not run where there are explosive fumes.
- is not used by those who may not understand how it should be used.
- is not loaded with food before it has time to get properly cold.

Install properly...

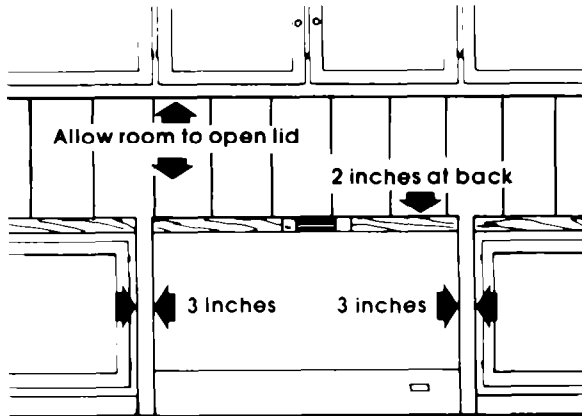

1. Check the strength of the floor. It should hold the weight of a fully loaded freezer.
2. **Pick a safe place, indoors, away from inflammables such as gasoline.**
3. Allow at least 3 inches (7.5 cm) air space on all sides of freezer and 2 inches (5 cm) at back. Leave room at top for lid to open all the way.
4. It should not be necessary to remove the lid during installation. If, for any reason, the hinges need adjustment, see your authorized WHIRLPOOL dealer.
5. **Do not cover the freezer with items such as blankets, sheets, tablecloths, etc.**

Level chest freezer...

from end to end and front to back so that the lid will seal properly.

Check with level

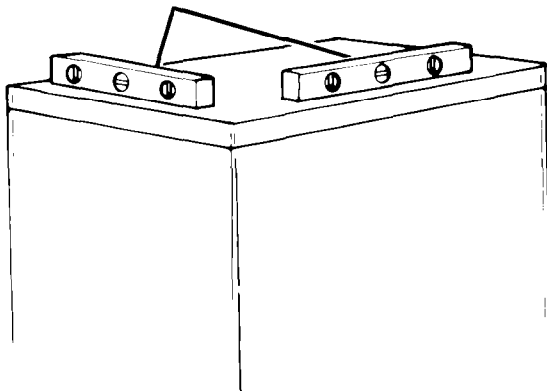

Remove sales labels...

Remove any labels before using the freezer.

To remove any remaining glue:

1. Rub briskly with thumb to make a ball, then remove.
- OR**
2. Soak area with dishwashing detergent solution (1 teaspoon detergent in 1 quart warm water) before removing glue as described in step 1.

DO NOT USE rubbing alcohol or flammable or toxic solvents, such as acetone, gasoline, carbon tetrachloride, etc. These can damage the material.

NOTE: DO NOT REMOVE the Tech Sheet on inside of compressor compartment door.

Clean it...

Clean your freezer before using it. See cleaning instructions on page 6.



Plug it in...

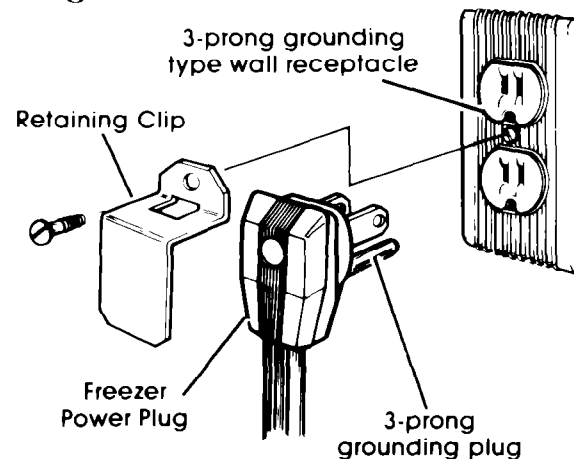

Recommended Grounding Method

A 115 Volt, 60 Hz., AC only 15 or 20 ampere fused and properly grounded electrical supply is required. It is recommended that a separate circuit serving only this appliance be provided. **Use a receptacle which cannot be turned off with a switch or pull chain. Do not use an extension cord.**

Attach retaining clip over power cord plug from literature package inside the freezer.

See individual electrical requirements and grounding instruction sheet in your literature package.

Using your freezer

Setting the temperature control...

1. Insert a coin in the slot of the Temperature Control to turn it.
2. Turn control to Number 3. This setting is designed to maintain the temperature at or near 0°F (-17.8°C) under normal operating conditions.

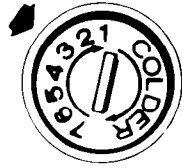

Adjusting the temperature control...

- Turn control to higher number for colder temperatures.
- Turn to lower number for less cold temperatures.

The sliding basket...

Can be moved from side to side or removed when loading or unloading food below it

To remove:
Lift basket out.

To replace:
Lower basket into place.

Cooling freezer first...

1. Allow freezer to cool 6 to 8 hours before filling with **frozen food**.
2. Let it cool overnight before adding large amount of **unfrozen food**.

NOTE: When freezer is first started the compressor will run constantly until the cabinet is cooled. It may take up to 6 to 8 hours or longer, depending on room temperature and the number of times the freezer lid is opened.

After the cabinet is cooled the compressor will turn on and off as needed to keep freezer at proper temperature.

The outside of your freezer may feel warm. This is normal. The freezer's design and main function is to remove heat from packages and air space inside the freezer. This heat is transferred to the room air, so the outside walls of the freezer may be warm.

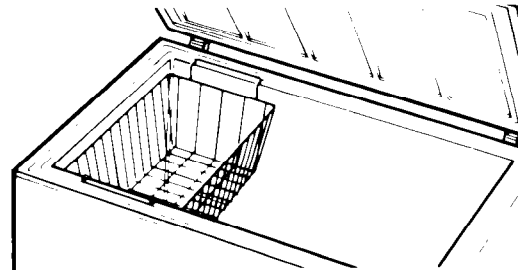

The key eject lock...

can help reduce the hazard of child entrapment.

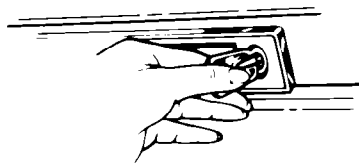

To lock or unlock the freezer you must hold the key in the lock while turning. The lock is spring loaded so the key cannot be left in the lock.

If the key is lost, contact your WHIRLPOOL dealer for a replacement. Always give the **complete** model and serial number of your freezer when requesting a replacement key.

The signal light...

automatically warns of any unexpected power failure.

If the signal light is not glowing, immediately check:

- for power interruption,
- for an unplugged power cord,
- for a burned out signal light.

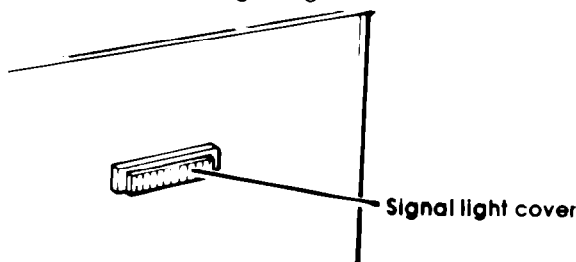

To replace:

1. Unplug power cord from outlet.
2. Carefully snap out light cover and assembly with a screwdriver by inserting it under the end of metal edge of the light. Be careful not to chip finish on freezer.
3. Unplug burned out signal light and replace with a new one. Signal light can be ordered from your WHIRLPOOL dealer.
4. Then, snap light assembly into place.
5. Plug power cord into outlet.

Energy Saving Tips...

- Check lid gasket and level cabinet to ensure a good lid seal. Keeping freezer locked ensures lid closure.
- Keep lid openings to a minimum. Remove several items at one time. Keep contents organized to eliminate searching.

- Fill to capacity. Follow recommended procedures for freezing foods.
- Set Temperature Control to provide temperatures around 0°F (-17.8°C). There is no need to store foods below 0°F.
- **Do not let frost build up to more than ¼ inch (6 mm) thick.**

Cleaning your freezer

This freezer should be cleaned when frost has built up to about ¼ inch (6 mm) thickness. Complete defrosting and cleaning should be done at least once a year. In high humidity areas, a freezer may need more frequent defrosting.

To defrost and clean:

1. Unplug freezer.
2. Take out all frozen food and sliding basket.

NOTE: Wrap frozen foods and packages in several layers of newspaper and cover with a blanket. Food will stay frozen several hours.

3. Clean freezer according to the following directions.

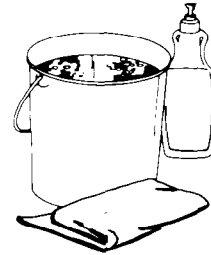

After defrosting:

1. Plug in freezer.
2. See directions for "Setting the Temperature Control," page 5.

Cleaning chart...

Part	What to use	How to clean
Removable part (basket)	Sponge or cloth; mild detergent and warm water	<ul style="list-style-type: none"> • Wash with warm water and a mild detergent. • Rinse and dry.
Outside	Sponge, cloth or paper towel; mild detergent; appliance wax (or good auto paste wax).	<ul style="list-style-type: none"> • Wash with warm water and a mild detergent. Do not use abrasive or harsh cleansers. • Rinse and dry • Wax painted metal surfaces at least twice a year with appliance wax or a good auto paste wax. Apply wax with a clean, soft cloth. Do not use wax on plastic parts.
Inside walls	Plastic scraper, pans of hot water, electric fan, sponge or towel, baking soda and warm water.	<p>Waxing painted metal surfaces provides rust protection.</p> <ul style="list-style-type: none"> • Use plastic scraper to remove frost. • Place pans of hot water in freezer with lid open to speed melting. Directing air from an electric fan into freezer will also help. • Remove water from walls with towel or sponge. • Wash with solution of 2 tablespoons (26 g) baking soda to 1 quart (.95 L) warm water. • Rinse and dry. • Do not use abrasive or harsh cleansers.
Lid liner and gasket	Sponge, soft cloth or paper towel; mild detergent and warm water.	<ul style="list-style-type: none"> • Wash with mild detergent and warm water. • Rinse and dry.

DO NOT USE an ice pick, knife of other sharp-pointed tool or any type of electric defroster to defrost freezer. They can cause damage to the liner and interior parts.

DO NOT USE cleaning waxes, concentrated detergents, bleaches or cleansers containing petroleum on plastic parts because they may damage these parts.

Freezing food in your freezer

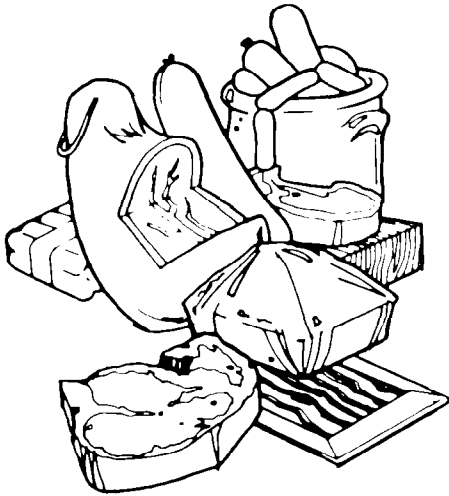

When freezer has cooled to a safe storage temperature, it may be loaded with **frozen food**.

When you plan to freeze **unfrozen food**, see the following chart for the amount to freeze at **one time**.

POUNDS OF FOOD TO FREEZE AT ONE TIME*		
Size of Freezer	Meat or Fish	Vegetables or Fruit
6 cu. ft. (170 L)	12 lbs. (5.4 kg)	18 lbs. (8.1 kg)
9 cu. ft. (255 L)	18 lbs. (8.1 kg)	27 lbs. (12.2 kg)

*These amounts are based on USDA recommendations. If too many packages of unfrozen food are packed at one time into the freezer, the rate of freezing is too slow. Poor quality products result.

Packaging and sealing food...

Airtight packaging is important in freezing foods. Containers and wrappings should be moisture and vapor-proof and packages should be sealed carefully to keep moisture in and air out.

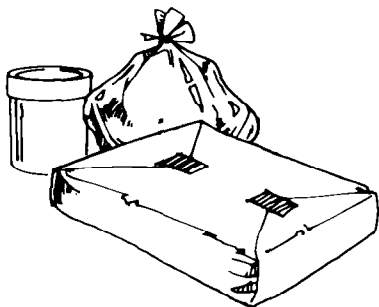

Freezer burn can result if food is not properly wrapped. When this happens, food dehydrates and is of poor quality.

To wrap foods...

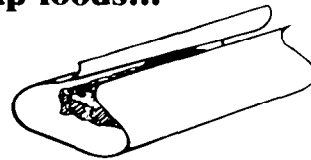

1. Cut sheet of wrapping material about one-third longer than distance around food to be wrapped. Place wrapping sheet on flat surface with food in center of sheet.

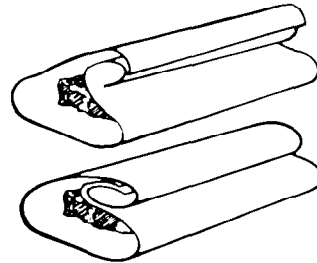

2. Bring front and back of wrapping together and fold in toward food, making at least two one-inch (2.5 cm) folds until food fits tightly against wrapping.



3. Crease ends close to food to eliminate air pockets.

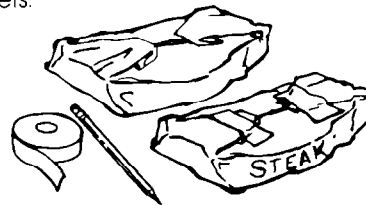

4. Press all air from package. Fold each end over twice. Make sure fold is tight and fasten against end of package with freezer tape.

NOTE: When packaging meats that have not been boned, pad sharp edges with extra wrap or use stockinette to protect against tearing or puncturing.

Use heavy-duty aluminum freezer foil, kraft paper with cellophane bonded to it, special freezer bags, jars, cartons and freezer sealing tape for packaging your food items. You'll find them at the supermarket or freezer dealer.

See the "Freezer Guide" for complete information and tips on home freezing.

Loading...

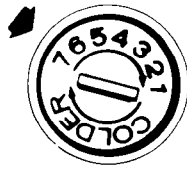

1. Before freezing large quantities of food, turn Temperature Control to highest setting and let freezer operate for several hours. **After loading all food items, return Temperature Control to the usual setting.**

Foods to be frozen near side wall

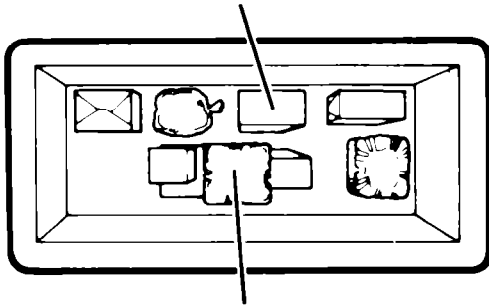

Packages already frozen

2. To speed freezing, place unfrozen packages near a side wall. Leave space between packages.
3. Add more unfrozen food after first load is frozen (approximately 18 to 24 hours). Stack frozen packages in center of freezer.

Storing frozen food...

After food is frozen, stack packages anywhere in the freezer. Packages should not extend above the cabinet edge or they may keep the lid from closing and sealing properly.

Basket – Store small packages here to avoid losing them in bottom of freezer.

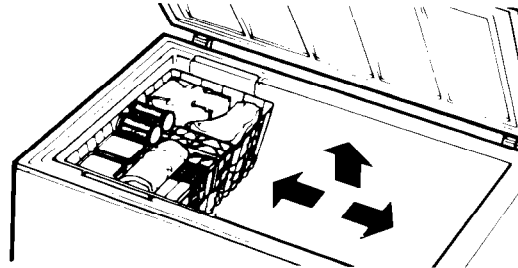

Vacation and moving care

Vacations...

Arrange for someone to make regular checks of your freezer to make sure it is operating and electricity has not been interrupted.



Shutting off and moving...

If freezer is shut off for more than 24 hours:

1. Remove and store all food.
2. Unplug freezer.
3. Clean thoroughly. See "Cleaning your freezer," page 6.
4. Block lid open for air circulation. Turn lock to locked position with lid open. Place blocks between lid and cabinet and tape in place with self-adhesive filament tape.

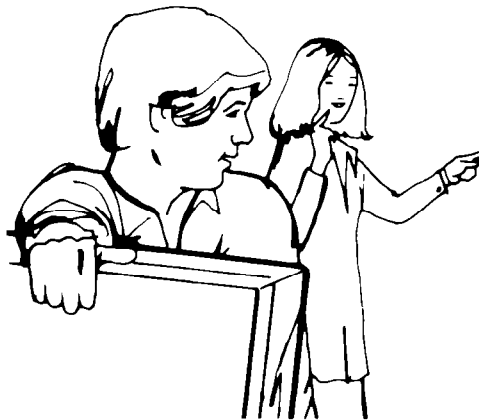

If you move the freezer:

1. Remove the sliding basket.
2. **Do not place objects inside or on top of cabinet.**
3. Level properly to ensure good lid seal.

CAUTION: To help prevent accidents, do not allow children near the freezer when the lid is blocked open.

To restart freezer, see "Using your freezer," page 5.

If you need service or assistance, we suggest you follow these five steps:



- Check fuse box or circuit breaker.

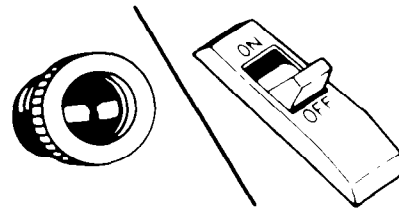

1. Before calling for assistance...

Performance problems often result from little things you can find and fix yourself without tools of any kind.

If electricity goes off:

Learn how long power will be off by calling the power company.

- If service is to be interrupted 24 hours or less, keep freezer closed. Most food will stay frozen.
- If service is to be interrupted longer than 24 hours, do this:
 1. Remove all unfrozen food and store in a frozen food locker. **OR...**
 2. Place 2 lbs. (0.9 kg) of dry ice in freezer for every cu. ft. of freezer space. This will keep frozen foods for 2 to 4 days. Wear gloves to protect your hands from dry ice burns.
 3. If neither food locker storage or dry ice is available, use or can perishable food at once.
- The length of time food will stay frozen depends on several factors. For instance: a full freezer will remain cold longer than a freezer partially filled. And a freezer full of meat will stay cold longer than a freezer filled with baked goods. Also, if the food still contains ice crystals, it may be safely refrozen, although the quality and flavor may be affected. Use this food as soon as convenient. If the condition of the food is poor or is in any way questionable, it is wise to dispose of it.

If freezer stops running:

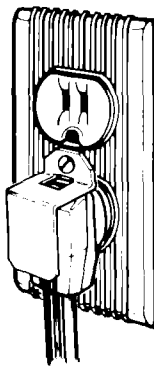

- Check to see if power cord is plugged into the outlet.

- Check electric company for a power failure.

If motor seems to run too long

1. If large amounts of unfrozen food have been put into the freezer, motor will run longer.
2. On hot summer days or if room is hot, motor will run longer to provide correct amount of cooling.

If freezer feels warm

During normal operating conditions the freezer transfers heat removed from food packages and air space to the outside room air. The freezer cabinet may feel warm.

If frost builds up on the trim strip around top of cabinet

1. Check the fit of the lid to make sure it is sealing. With the lid closed, press down firmly on the edges or at the center of the lid. This pressure will cause the flexible lid to fit flat against the cabinet and seal.
2. Do not open or close the lid by grasping a corner. Use the handle.

2. If you need assistance*...

Call Whirlpool COOL-LINE® service assistance telephone number. Dial free from anywhere in the U.S.:

1-800-253-1301

and talk with one of our trained Consultants. The Consultant can instruct you in how to obtain satisfactory operation from your appliance or, if service is necessary, recommend a qualified service company in your area.

3. If you need service*...



Whirlpool has a nationwide network of franchised TECH-CARE* Service Companies. TECH-CARE service technicians are trained to fulfill the product warranty and provide after-warranty service, anywhere in the United States. To locate

TECH-CARE service in your area, call our COOL-LINE service assistance telephone number (see Step 2) or look in your telephone directory Yellow Pages under:

APPLIANCES - HOUSEHOLD - MAJOR - SERVICE & REPAIR

WHIRLPOOL APPLIANCES
FRANCHISED TECH-CARE SERVICE

SERVICE COMPANIES
XYZ SERVICE CO
123 MAPLE 999-9999

ELECTRICAL APPLIANCES - MAJOR - REPAIRING & PARTS

WHIRLPOOL APPLIANCES
FRANCHISED TECH-CARE SERVICE

SERVICE COMPANIES
XYZ SERVICE CO
123 MAPLE 999-9999

OR

WASHING MACHINES, DRYERS & IRONERS - SERVICING

WHIRLPOOL APPLIANCES
FRANCHISED TECH-CARE SERVICE

SERVICE COMPANIES
XYZ SERVICE CO
123 MAPLE 999-9999

4. If you have a problem*...

Call our COOL-LINE service assistance telephone number (see Step 2) and talk with one of our Consultants, or if you prefer, write to:

Mr. Robert Stanley
Division Vice President
Whirlpool Corporation
2000 M-63
Benton Harbor, MI 49022

5. If you need FSP® replacement parts*...

FSP is a registered trademark of Whirlpool Corporation for quality parts. Look for this symbol of quality whenever you need a replacement part for your Whirlpool appliance. FSP replacement parts will fit right and work right, because they are made to the same exacting specifications used to build every new Whirlpool appliance.

To locate FSP replacement parts in your area, refer to Step 3 above or call the Whirlpool COOL-LINE service assistance number in Step 2.

*If you must call or write, please provide: model number, serial number, date of purchase, and a complete description of the problem. This information is needed in order to better respond to your request for assistance.

WHIRLPOOL® DOMESTIC, UL COMMERCIAL LISTED AND NSF® FREEZER WARRANTY

LENGTH OF WARRANTY	WHIRLPOOL WILL PAY FOR
FULL ONE YEAR WARRANTY From Date of Purchase	FSP® replacement parts and repair labor to correct defects in materials or workmanship.
FULL FIVE YEAR WARRANTY From Date of Purchase	FSP® replacement parts and repair labor to correct defects in materials or workmanship in the sealed refrigeration system. These parts are: <ol style="list-style-type: none"> 1. Compressor 2. Evaporator 3. Condenser 4. Dryer 5. Connecting tubing
WHIRLPOOL WILL NOT PAY FOR	
<p>A. Service calls to:</p> <ol style="list-style-type: none"> 1. Correct the installation of the freezer. 2. Instruct you how to use the freezer. 3. Replace house fuses or correct house wiring or plumbing. 4. Replace light bulbs or batteries. <p>B. Pick up and delivery. This product is designed to be repaired in the home or commercial establishment.</p> <p>C. Damage to freezer caused by accident, misuse, fire, flood, acts of God or use of products not approved by Whirlpool.</p> <p>D. Food loss coverage for UL commercial listed and NSF® freezers used in commercial applications.</p>	

Limited domestic food loss coverage. See below for details on limited domestic food loss protection plan. Service under the full warranties must be provided by a franchised TECH-CARE® service company.

WHIRLPOOL CORPORATION SHALL NOT BE LIABLE FOR INCIDENTAL OR CONSEQUENTIAL DAMAGES. Some states do not allow the exclusion or limitation of incidental or consequential damages so this limitation or exclusion may not apply to you. This warranty gives you specific legal rights, and you may also have other rights which vary from state to state.

Outside the United States, a different warranty may apply. For details, please contact your authorized Whirlpool distributor or military exchange.

LIMITED DOMESTIC FOOD LOSS COVERAGE REIMBURSEMENT FOR FOOD LOSSES

During the first year of ownership, the Whirlpool Freezer warranty provides reimbursement as outlined below for food actually spoiled while stored in the freezer as a result of defects in materials or workmanship.

During the second through fifth years of ownership, reimbursement will be made as outlined below for food actually spoiled while stored in the freezer as a result of a **FAILURE OF THE SEALED REFRIGERATION SYSTEM.**

Food spoilage losses must be verified by Whirlpool or a Whirlpool Franchised TECH-CARE® service company. Reimbursement of loss will be based on domestic use and freezer size up to the total cumulative amount shown for the 5 year warranty period.

9.9 cu. ft. or smaller	up to \$ 75.00 maximum payment
10.0 cu. ft. to 16.0 cu. ft.	up to \$125.00 maximum payment
16.1 cu. ft. and larger	up to \$200.00 maximum payment

The reimbursement amounts shown are representative for the contents of typical freezers by size and may or may not cover the actual replacement costs of the contents of your freezer. They are the maximum amounts, however, that will be paid and they are cumulative for the five year warranty period.

Sorry, but Whirlpool is not responsible for food losses caused by natural spoilage, misuse or negligent care of the freezer, or by accidental or intentional disconnecting of the electric power cord, power interruption, inadequate power, fire damage, water damage, theft, or riots, strikes, war or acts of God.



Free Manuals Download Website

<http://myh66.com>

<http://usermanuals.us>

<http://www.somanuals.com>

<http://www.4manuals.cc>

<http://www.manual-lib.com>

<http://www.404manual.com>

<http://www.luxmanual.com>

<http://aubethermostatmanual.com>

Golf course search by state

<http://golfingnear.com>

Email search by domain

<http://emailbydomain.com>

Auto manuals search

<http://auto.somanuals.com>

TV manuals search

<http://tv.somanuals.com>